

Kanlux

Katalog
Catalogue
2020 | 2021

more than
light.



więcej niż
more than **światło.**
light.





Nam możesz zaufać

You can
trust us

**Kanlux nie jest zwykłą firmą, my rozumiemy
Twoje potrzeby. Dzielimy się pasją, a naszą
inspiracją jesteś Ty. Nasz cel i misja to
kreowanie światła, które rozświetli
Twój dzień i noc.**

Kanlux is not an ordinary company
- we understand your needs.
We share our passion and you are
our inspiration. Our purpose and mission
is to create light that will illuminate
your day and night.



Kanlux



16
43

OPRAWY Z FABRYKI KANLUX

KANLUX FACTORY FIXTURES

44
119

ŹRÓDŁA ŚWIATŁA

LIGHT SOURCES

120
233

OPRAWY DOMOWE I DEKORACYJNE

DOMESTIC AND DECORATIVE FIXTURES

234
331

OPRAWY TECHNICZNE I ARCHITEKTONICZNE

TECHNICAL AND ARCHITECTURAL FIXTURES

332
371

OSPRZĘT ELEKTROINSTALACYJNY

ELECTRICAL INSTALLATION EQUIPMENT

OPRAWY Z FABRYKI KANLUX KANLUX FACTORY FIXTURES



Kanlux ALIN LED
◀ 18 - 23 ▶



Kanlux ALIN LED LINE
◀ 24 - 29 ▶



Kanlux ALIN 4LED
◀ 30 - 31 ▶



Kanlux OFIS LED
◀ 32 - 35 ▶



Kanlux OFIS S LED
◀ 36 - 37 ▶



Kanlux FUTURIO LED
◀ 38 - 41 ▶

Kanlux
FACTORY

ŹRÓDŁA ŚWIATŁA LIGHT SOURCES



Kanlux IQ-LED A60
◀ 46 ▶



Kanlux IQ-LED A67
◀ 47 ▶



Kanlux IQ-LEDDIM A60
◀ 48 ▶



Kanlux XLED A60
◀ 49 ▶



Kanlux XLED A70
◀ 50 ▶



Kanlux XLED A60M
◀ 51 ▶



Kanlux XLED A60 B22
◀ 52 ▶



Kanlux XLED STEPDIM
◀ 53 ▶



Kanlux XLED CCT
◀ 53 ▶



Kanlux RAPID E27 - NEW
◀ 54 ▶



Kanlux LUNI LED
◀ 55 ▶



Kanlux XLED ST64
◀ 56 ▶



Kanlux XLED G125
◀ 56 ▶



Kanlux XLED SW
◀ 57 ▶



Kanlux IQ-LED C37
◀ 58 ▶



Kanlux XLED C35
◀ 59 ▶



Kanlux XLED C35M
◀ 60 ▶



Kanlux DUN LED
◀ 61 ▶



Kanlux DUN HI LED
◀ 62 ▶



Kanlux IDO LED
◀ 63 ▶



Kanlux IQ-LED G45
◀ 64 ▶



Kanlux XLED G45
◀ 65 ▶



Kanlux XLED G45M
◀ 66 ▶



Kanlux BILO LED
◀ 67 ▶



Kanlux BILO HI LED
◀ 68 ▶



Kanlux IQ-LED GU10
◀ 69 ▶



Kanlux IQ-LEDIM GU10
◀ 70 ▶



Kanlux REMI LED
◀ 70 ▶



Kanlux TOMI LED
◀ 71 ▶



Kanlux FULLED
◀ 72 ▶



Kanlux TEDI MAXX LED
◀ 72 ▶



Kanlux LED15 C
◀ 73 ▶



Kanlux TOMI LED
◀ 73 ▶



Kanlux SIGO LED
◀ 74 ▶



Kanlux GIO LED G9
◀ 75 ▶



Kanlux G9 GLASS
◀ 75 ▶



Kanlux ZUBI LED
◀ 76 ▶



Kanlux GIO LED G4
◀ 77 ▶



Kanlux TANO G4 SMD
◀ 77 ▶



Kanlux LED12 G4
◀ 78 ▶



Kanlux AR-111 LED
◀ 79 ▶



Kanlux ES-111 LED
◀ 80 ▶



Kanlux T8 LED GLASSv2
◀ 82 ▶



Kanlux T8 LED GLASSv3
◀ 83 ▶



Kanlux T8 LED GLASSv3T
◀ 84 ▶



Kanlux T8 LED GLASSv4
◀ 85 ▶



Kanlux ESG LED
◀ 86 ▶



Kanlux MODv2 LED
◀ 87 ▶



Kanlux RANGO LED
◀ 88 ▶

ŹRÓDŁA ŚWIATŁA LIGHT SOURCES

						
Kanlux LEDS-B ◀ 89 ▶	Kanlux LED STRIP L60 ◀ 90 ▶	Kanlux LED STRIP LI20 ◀ 91 ▶	Kanlux LED STRIP LCOB ◀ 92 ▶	Kanlux LED STRIP LI20 CCT ◀ 93 ▶	Kanlux LEDS-B RGB ◀ 94 ▶	Kanlux LED STRIP L48 RGBW ◀ 95 ▶
						
Kanlux LEDS SET ◀ 96 ▶	Kanlux CONTROLLER MONO ◀ 97 ▶	Kanlux CONTROLLER CCT ◀ 97 ▶	Kanlux CONTROLLER ◀ 98 ▶	Kanlux CONTROLLER RGBW ◀ 99 ▶	Kanlux PROFILO A ◀ 100 ▶	Kanlux PROFILO B ◀ 101 ▶
						
Kanlux PROFILO C ◀ 102 ▶	Kanlux PROFILO D ◀ 103 ▶	Kanlux PROFILO E ◀ 104 ▶	Kanlux PROFILO F ◀ 105 ▶	Kanlux PROFILO G ◀ 106 ▶	Kanlux PROFILO H ◀ 107 ▶	Kanlux PROFILO I ◀ 108 ▶
						
Kanlux PROFILO J ◀ 109 ▶	Kanlux PROFILO K ◀ 110 ▶	Kanlux GIVRO ◀ 111 ▶	Kanlux G9 STAR ◀ 112 ▶	Kanlux JC BASIC ◀ 113 ▶	Kanlux J ◀ 114 ▶	Kanlux J STAR ◀ 114 ▶
						
Kanlux TZU ◀ 115 ▶	Kanlux TIU ◀ 115 ▶	Kanlux DD ◀ 116 ▶	Kanlux T5 ◀ 117 ▶	Kanlux T8 ◀ 118 ▶	Kanlux MHE ◀ 119 ▶	

Kanlux ETISSA ◀ 122 ▶

OPRAWY DOMOWE I DEKORACYJNE DOMESTIC AND DECORATIVE FIXTURES

						
Kanlux OGIVA ◀ 122 ▶	Kanlux ALGO ◀ 123 ▶	Kanlux SONOR GU10 ◀ 124 ▶	Kanlux STOBI ES ◀ 125 ▶	Kanlux STOBI ◀ 126-127 ▶	Kanlux TUBEO ES ◀ 128 ▶	Kanlux BLURRO ◀ 130 ▶

OPRAWY DOMOWE I DEKORACYJNE DOMESTIC AND DECORATIVE FIXTURES



Kanlux SANI IP44
◀ 131 ▶



Kanlux LUNATI
◀ 131 ▶



Kanlux BORD
◀ 132-133 ▶



Kanlux GORD
◀ 134 ▶



Kanlux RITI
◀ 135 ▶



Kanlux TOLEO
◀ 136-137 ▶



Kanlux ALGO
◀ 138 ▶



Kanlux DUCE
◀ 139 ▶



Kanlux TORIM
◀ 139 ▶



Kanlux MERSA
◀ 140 ▶



Kanlux JASMIN
◀ 141 ▶



Kanlux TIVA
◀ 142 ▶



Kanlux ARDEA
◀ 143 ▶



Kanlux PLAFMIN
◀ 143 ▶



Kanlux LAURIN
◀ 144-145 ▶



Kanlux SEMPRA
◀ 146-147 ▶



Kanlux ENALI
◀ 148-149 ▶



Kanlux MILENO
◀ 150-151 ▶



Kanlux EVELI
◀ 152 ▶



Kanlux GLASO
◀ 153 ▶



Kanlux SONDA
◀ 154 ▶



Kanlux MOLLI
◀ 155 ▶



Kanlux SILMA LED
◀ 156 ▶



Kanlux TUME LED
◀ 157 ▶



Kanlux MINI RITI
◀ 158 ▶



Kanlux MINI BORD
◀ 159 ▶



Kanlux MINI GORD
◀ 159 ▶



Kanlux GOVIK DSO
◀ 160 ▶



Kanlux AJAS DSO
◀ 161 ▶



Kanlux SIMEN DSO
◀ 162 ▶



Kanlux SIMEN DSL
◀ 163 ▶



Kanlux CHIRO GU10
◀ 164 ▶



Kanlux SPAG
◀ 165 ▶



Kanlux LUNIO
◀ 166 ▶



Kanlux IMINES
◀ 166 ▶



Kanlux BONIS
◀ 167 ▶



Kanlux ELNIS S
◀ 168 ▶



Kanlux ELNIS L
◀ 169 ▶



Kanlux SEIDY
◀ 170-171 ▶



Kanlux DALLA
◀ 172 ▶



Kanlux MORTA
◀ 173 ▶



Kanlux MORTA DT
◀ 174 ▶



Kanlux MORTA B
◀ 175 ▶



Kanlux MORTA OCT
◀ 176 ▶



Kanlux APRILA
◀ 176 ▶



Kanlux SOREN
◀ 177 ▶



Kanlux IVRI
◀ 178 ▶



Kanlux CEMIN
◀ 178 ▶



Kanlux CEL
◀ 178 ▶

OPRAWY DOMOWE I DEKORACYJNE DOMESTIC AND DECORATIVE FIXTURES



Kanlux ARET
◀ 179 ▶



Kanlux MERIL
◀ 180 ▶



Kanlux ALREN R
◀ 180 ▶



Kanlux ALREN
◀ 181 ▶



Kanlux COLIE
◀ 182 ▶



Kanlux NESTA
◀ 183 ▶



Kanlux EVIT
◀ 184 ▶



Kanlux GWEN
◀ 184 ▶



Kanlux VIDI
◀ 185 ▶



Kanlux NAVI
◀ 186 ▶



Kanlux LUTO
◀ 187 ▶



Kanlux RADAN
◀ 188 ▶



Kanlux TESON
◀ 189 ▶



Kanlux FLINI IP44
◀ 190 ▶



Kanlux QULES
◀ 192 ▶



Kanlux MARIN
◀ 193 ▶



Kanlux ARGUS
◀ 194-195 ▶



Kanlux ALOR
◀ 196 ▶



Kanlux BASK
◀ 197 ▶



Kanlux HORN
◀ 198 ▶



Kanlux URTICA
◀ 199 ▶



Kanlux CANTA
◀ 199 ▶



Kanlux DINO
◀ 200 ▶



Kanlux NOMA
◀ 200 ▶



Kanlux IMBER LED
◀ 201 ▶



Kanlux HAXA LED
◀ 201 ▶



Kanlux OYO LED
◀ 202 ▶



Kanlux TONIL LED
◀ 203 ▶



Kanlux ASIL
◀ 204 ▶



Kanlux PESSA LED
◀ 205 ▶



Kanlux ROLSO LED
◀ 205 ▶



Kanlux ASTEN LED
◀ 206-207 ▶



Kanlux ERINUS LED
◀ 208-209 ▶



Kanlux APUS LED
◀ 210 ▶



Kanlux TERRA LED
◀ 211 ▶



Kanlux SEORA LED
◀ 212 ▶



Kanlux SABIK LED
◀ 213 ▶



Kanlux SOLA LED
◀ 214 ▶



Kanlux MEFIS LED
◀ 215 ▶



Kanlux MERA LED
◀ 216 ▶



Kanlux MERA
◀ 217 ▶



Kanlux LINUS LED
◀ 218 ▶



Kanlux ZEPO
◀ 218 ▶



Kanlux PAX LED
◀ 219 ▶



Kanlux PIRMO LED
◀ 219 ▶



Kanlux GAVI LED
◀ 219 ▶



Kanlux GAVI
◀ 220 ▶



Kanlux RUBINAS LED
◀ 221 ▶



Kanlux ZAFIRAS LED
◀ 221 ▶

OPRAWY DOMOWE I DEKORACYJNE DOMESTIC AND DECORATIVE FIXTURES

						
Kanlux DB ◀ 222 ▶	Kanlux DIM ◀ 222 ▶	Kanlux DRIFT ◀ 222 ▶	Kanlux DOSAN LED ◀ 223 ▶	Kanlux REXAR LED ◀ 224-225 ▶	Kanlux ISTI LED ◀ 226 ▶	Kanlux AWAN LED ◀ 226 ▶
						
Kanlux SARI LED ◀ 227 ▶	Kanlux FOLLO LED ◀ 228 ▶	Kanlux FRANCO LED ◀ 228 ▶	Kanlux SUZI ◀ 229 ▶	Kanlux ZARA ◀ 230 ▶	Kanlux HERON LED ◀ 231 ▶	Kanlux PIXA ◀ 231 ▶
		<h2>OPRAWY TECHNICZNE I ARCHITEKTONICZNE TECHNICAL AND ARCHITECTURAL FIXTURES</h2>				
Kanlux DAIBO LED ◀ 232-233 ▶	Kanlux CYDEA ◀ 233 ▶					

						
Kanlux BLINGO BL ◀ 236-237 ▶	Kanlux BRAVO P / PU ◀ 238-239 ▶	Kanlux BRAVO S / SU ◀ 240-241 ▶	Kanlux TOWE LED ◀ 242 ▶	Kanlux BRASO LED ◀ 242 ▶	Kanlux AVAR LED ◀ 243 ▶	Kanlux REGIS ◀ 244 ▶
						
Kanlux REGIS 4LED ◀ 245 ▶	Kanlux NOTUS ◀ 246 ▶	Kanlux NOTUS PREMIUM ◀ 247 ▶	Kanlux NOTUS 4LED ◀ 248 ▶	Kanlux TP STRONG ◀ 250 ▶	Kanlux MAH LED N ◀ 251 ▶	Kanlux MAH LED HI ◀ 251 ▶
						
Kanlux KRALA LED ◀ 252 ▶	Kanlux TP SLIM LED ◀ 253 ▶	Kanlux NOME N ◀ 254 ▶	Kanlux MAH PLUS 4LED ◀ 255 ▶	Kanlux MAH PLUS ◀ 256 ▶	Kanlux MEBA 4LED ◀ 257 ▶	Kanlux ALDO 4LED ◀ 258-259 ▶
						
Kanlux BENO LED ◀ 260-261 ▶	Kanlux VARSO LED ◀ 262-263 ▶	Kanlux ORTE LED ◀ 264 ▶	Kanlux DABA N LED SMD ◀ 265 ▶	Kanlux TYBIA LED ◀ 265 ▶	Kanlux BIGGE LED ◀ 266 ▶	Kanlux SANZO LED ◀ 266 ▶

OPRAWY TECHNICZNE I ARCHITEKTONICZNE TECHNICAL AND ARCHITECTURAL FIXTURES

						
Kanlux PORTOS LED ◀ 267 ▶	Kanlux FOGLER LED ◀ 267 ▶	Kanlux FOGLER DL ◀ 268 ▶	Kanlux JURBA DL ◀ 268 ▶	Kanlux PIRES DL ◀ 269 ▶	Kanlux KIRA DL ◀ 270 ▶	Kanlux MARC DL ◀ 270 ▶
						
Kanlux INES ◀ 271 ▶	Kanlux MILO ◀ 271 ▶	Kanlux SANGA DL ◀ 272 ▶	Kanlux HERMI ◀ 272 ▶	Kanlux TUNA ◀ 273 ▶	Kanlux TURK ◀ 273 ▶	Kanlux SHARK N ◀ 274 ▶
						
Kanlux MATEO ES ◀ 276 ▶	Kanlux MATEO ◀ 277 ▶	Kanlux ARTO ◀ 278 ▶	Kanlux RALF ◀ 278 ▶	Kanlux TIBERI LED ◀ 278 ▶	Kanlux IVIAN LED ◀ 279 ▶	Kanlux LITEN LED ◀ 279 ▶
						
Kanlux AREL LED ◀ 280-281 ▶	Kanlux ROUNDA V2LED ◀ 282 ▶	Kanlux KATRO V2LED ◀ 283 ▶	Kanlux NIKOR ◀ 284 ▶	Kanlux OMERIS LED ◀ 284 ▶	Kanlux CARSA V2LED ◀ 285 ▶	Kanlux KANTI V2LED ◀ 285 ▶
						
Kanlux FL MASTER LED ◀ 286 ▶	Kanlux FLM LED ◀ 287 ▶	Kanlux ANTEM LED ◀ 288 ▶	Kanlux ANTOS LED ◀ 289 ▶	Kanlux STATO LED ◀ 290 ▶	Kanlux ADAMO MTH ◀ 291 ▶	Kanlux AVIA MTH ◀ 291 ▶
						
Kanlux HB MASTER LED ◀ 292-293 ▶	Kanlux HB PRO LED HI ◀ 294-295 ▶	Kanlux STREET LED ◀ 296-297 ▶	Kanlux BART EL ◀ 298 ▶	Kanlux LART EL ◀ 298 ▶	Kanlux MAGRA EL ◀ 299 ▶	Kanlux DARSA EL ◀ 299 ▶
						
Kanlux ZEW EL ◀ 300 ▶	Kanlux REKA LED ◀ 301 ▶	Kanlux BISO LED ◀ 302 ▶	Kanlux FORRO LED ◀ 302 ▶	Kanlux GARTO LED ◀ 303 ▶	Kanlux ONSTAR LED ◀ 303 ▶	Kanlux CROTO LED ◀ 304 ▶

OPRAWY TECHNICZNE I ARCHITEKTONICZNE TECHNICAL AND ARCHITECTURAL FIXTURES



Kanlux LINDA LED
◀ 304 ▶



Kanlux DORA LED
◀ 305 ▶



Kanlux TAXI SMD
◀ 306 ▶



Kanlux TURRO LED
◀ 308 ▶



Kanlux XARD DL
◀ 308 ▶



Kanlux BERG DL
◀ 309 ▶



Kanlux GORDO LED14
◀ 309 ▶



Kanlux MORO DL
◀ 310 ▶



Kanlux ROGER DL
◀ 310 ▶



Kanlux INVO OP
◀ 312 ▶



Kanlux INVO TR
◀ 313 ▶



Kanlux SEVIA LED
◀ 314 ▶



Kanlux DROMI LED
◀ 315 ▶



Kanlux NOVIA
◀ 316 ▶



Kanlux GORI
◀ 317 ▶



Kanlux VADRA
◀ 318 ▶



Kanlux SORTA
◀ 319 ▶



Kanlux RILA
◀ 320 ▶



Kanlux GRIBLO LED
◀ 321 ▶



Kanlux AKVEN LED
◀ 321 ▶



Kanlux IDAVA
◀ 322 ▶



Kanlux STONO
◀ 323 ▶



Kanlux STONO IS
◀ 323 ▶



Kanlux SOLCA L
◀ 324 ▶



Kanlux SOLCA O
◀ 325 ▶



Kanlux ATLI
◀ 326-327 ▶



Kanlux ATL2 GU10
◀ 328-329 ▶



Kanlux TEAR N
◀ 330-331 ▶



Kanlux ALER MINI
◀ 334 ▶



Kanlux ALER JQ
◀ 334 ▶

OSPRZĘT ELEKTROINSTALACYJNY ELECTRICAL INSTALLATION EQUIPMENT



Kanlux ZONA JQ
◀ 335 ▶



Kanlux MARID JQ
◀ 335 ▶



Kanlux MERGE JQ
◀ 336 ▶



Kanlux ROLF MINI JQ
◀ 336 ▶



Kanlux ROLF JQ
◀ 337 ▶



Kanlux SLICK JQ
◀ 337 ▶



Kanlux MERGE JQ-O
◀ 338 ▶



Kanlux ROLF JQ-O
◀ 338 ▶



Kanlux MERGE O
◀ 339 ▶



Kanlux MERGE L
◀ 339 ▶



Kanlux SENTO
◀ 340 ▶



Kanlux SENZO
◀ 340 ▶



Kanlux ZONA
◀ 342 ▶



Kanlux AZ-10A
◀ 342 ▶

OSPRZĘT ELEKTROINSTALACYJNY ELECTRICAL INSTALLATION EQUIPMENT



Kanlux CYBER
◀ 343 ▶



Kanlux STER TS-MF
◀ 343 ▶



Kanlux ADI 350 1x3W
◀ 344 ▶



Kanlux DRIFT
◀ 344 ▶



Kanlux CIRCO
◀ 345 ▶



Kanlux DRIVE LED
◀ 345 ▶



Kanlux POWELED
◀ 345 ▶



Kanlux RICO LED
◀ 346 ▶



Kanlux STEL LED
◀ 346 ▶



Kanlux SET
◀ 346 ▶



Kanlux TRETO LED
◀ 347 ▶



Kanlux DimGO
◀ 347 ▶



Kanlux BL
◀ 348 ▶



Kanlux BS
◀ 348 ▶



Kanlux WIR ZL
◀ 349 ▶



Kanlux TWISTER
◀ 350 ▶



Kanlux CYKLON
◀ 351 ▶



Kanlux LUNGA
◀ 352 ▶



Kanlux LUNGA S
◀ 353 ▶



Kanlux NOKA W
◀ 354 ▶



Kanlux NOKA O
◀ 354 ▶



Kanlux DIVISO
◀ 355 ▶



Kanlux GP-2
◀ 355 ▶



Kanlux GRIP
◀ 355 ▶



Kanlux PIN W/US
◀ 356 ▶



Kanlux STAN GP
◀ 356 ▶



Kanlux W-1 NANO
◀ 356 ▶



Kanlux ZARK
◀ 357 ▶



Kanlux APO
◀ 357 ▶



Kanlux BR-GZ10
◀ 358 ▶



Kanlux HLDR-E14
◀ 358 ▶



Kanlux HLDR-E14-F
◀ 358 ▶



Kanlux HLDR-E27
◀ 359 ▶



Kanlux HLDR-E27-D
◀ 359 ▶



Kanlux HLDR-E27-F
◀ 359 ▶



Kanlux HLDR-G9
◀ 360 ▶



Kanlux HLDR-GX5.3
◀ 360 ▶



Kanlux HLDR-GZ10
◀ 360 ▶



Kanlux HLDR-R7S
◀ 361 ▶



Kanlux HLDR-E14/GU10
◀ 361 ▶



Kanlux HLDR-E27/GU10
◀ 361 ▶



Kanlux iTech
◀ 362 ▶



Kanlux ONTEC S
◀ 363-364 ▶



Kanlux ONTEC R
◀ 365 ▶



Kanlux ONTEC G
◀ 366 ▶



Kanlux ONTEC C
◀ 366 ▶



Kanlux VIP ST2
◀ 367 ▶



Kanlux PICTO G
◀ 368 ▶



Kanlux PICTO S
◀ 369 ▶

OSPRZĘT ELEKTROINSTALACYJNY ELECTRICAL INSTALLATION EQUIPMENT



Kanlux STRAP
◀ 370 ▶



Kanlux IT
◀ 370 ▶



Kanlux



Kanlux FACTORY

OPRAWY Z FABRYKI KANLUX KANLUX FACTORY FIXTURES

Nasze kompletne rozwiązania możemy dostosować specjalnie do Twoich potrzeb. Dbłość o każdy szczegół i idealne dopasowanie to właśnie produkty z Fabryki Kanlux. Poznaj je już dziś!

Our complete solutions can be adjusted to your needs. Attention to every detail and perfect fit are what characterises Kanlux Factory products. Discover them today!



*dane fotometryczne znajdziesz na:
 photometric data you can find on:*

► kanlux.com

ALIN LED

OPRAWA LINIOWA LED ► LINEAR LIGHTING FIXTURES



Kanlux ALIN LED to produkt, który powstał z myślą o oprawie idealnej. Stworzyli go projektanci Kanlux, którzy połączyli innowację z 30-letnim doświadczeniem. Markowe komponenty i perfekcyjne wykonanie zapewniają estetykę i trwałość działania przez długie lata. Szeroka oferta modeli daje możliwość dopasowania oprawy do potrzeb każdej inwestycji.

5 lat Gwarancji na warunkach oświadczenia gwarancyjnego, dostępnego na stronie internetowej: www.kanlux.com

The Kanlux ALIN LED is a product which was created with a view to a perfect fixture. It was created by the Kanlux designers, who combined innovation with 30 years of experience. Their branded components and perfect workmanship ensure the aesthetics and durability of operation for many years. The wide range of models affords the possibility to adjust the fixture to the needs of each investment.

5 years Warranty under the terms of the warranty statement, available on our website: www.kanlux.com



ALIN LED ... NT

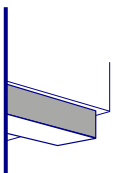

NATYNKOWA
SURFACE
MOUNTED



ALIN LED ... PT

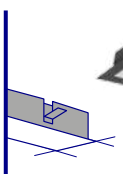

PODTYNKOWA
RECESSED
MOUNTED



ALIN LED ... NT + ALIN CORD + ROPE

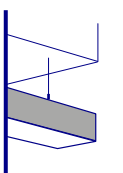

ZWIESZANA
SUSPENDED
MOUNTED



ALIN LED ... NT + ALIN GRIP

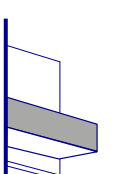

DO NADBUDOWANIA
NA ŚCIANIE
WALL MOUNTED

CONFIGURATOR



Wyprodukujemy dla Ciebie oprawę idealną. Stwórz ją z pomocą naszego konfiguratora.

We will produce a perfect luminaire for you. Create it with our configurator.



CO NAS WYRÓŻNIA?

TRZY DŁUŻOŚCI
THREE LENGTHS

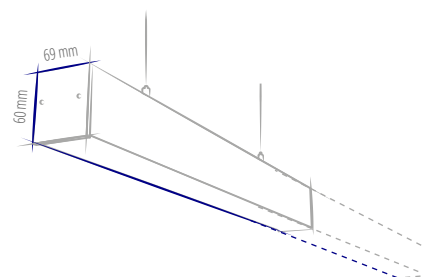

LEGENDA ► KEY

AL	KANLUX ALIN LED
ALD	KANLUX ALIN LED DALI
11W-50W	moc [W] / power [W]
830	Ra ≥ 80 3000K
840	Ra ≥ 80 4000K
MAT	klosz matowy / matt lampshade
MPR	klosz mikropryzmatyczny / microprismatic lampshade
RST	raster / louvre
W	kolor obudowy: biały / housing colour: white
B	kolor obudowy: czarny / housing colour: black
SR	kolor obudowy: srebrny / housing colour: silver
PT	wersja podtynkowa / recessed mounted
NT	wersja natynkowa / surface-mounted
ALIN +ALIN CORD +ROPE	wersja wisząca / suspended mounted
ALIN +ALIN NT GRIP	wersja do nadbudowania na ścianie / wall mounted
SE	wersja z czujnikiem ruchu / motion sensor

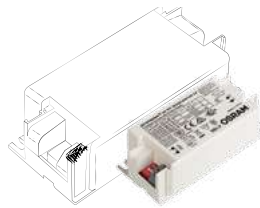

ZASILACZ MARKI OSRAM
POWER SUPPLY BY OSRAM



BIAŁY
WHITE

CZARNY
BLACK

SREBNY
SILVER

TRZY KOLORY OBUDOWY
THREE HOUSING COLORS

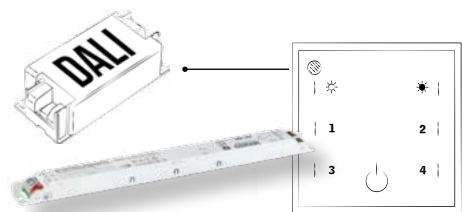

OPCJONALNIE STEROWANIE DALI
DALI LED DRIVER AVAILABLE AS AN OPTION

WHAT MAKES US DIFFERENT?

DWIE BARWY ŚWIATŁA
TWO COLOR TEMPERATURES



CIEPŁO BIAŁA
WARM WHITE



NEUTRALNA
NEUTRAL

TRZY RODZAJE DYFUZORA
THREE TYPES OF DIFFUSER

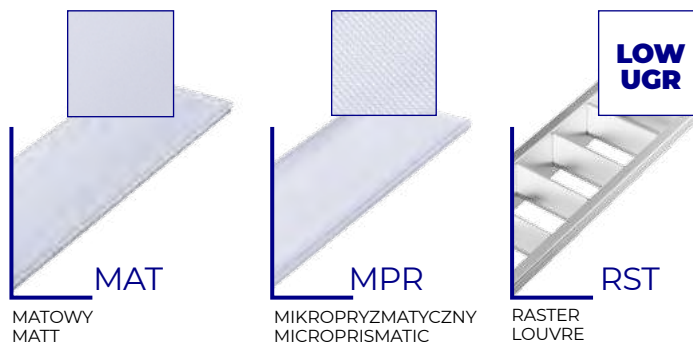

MATOWY
MATT

MIKROPRYZMATYCZNY
MICROPRISMATIC

RASTER
LOUVRE

LOW
UGR

WYSOKIEJ JAKOŚCI
MODUŁ LED
HIGH QUALITY
LED MODULE



ALIN LED ... NT

OPRAWA LINIOWA LED WERSJA NATYNKOWA ► LINEAR LED LUMINAIRE SURFACE-MOUNTED

mm **11W** 573mm **23W** 1133mm **35W** 1693mm
17W **33W** **50W**

AL 11W-830-MAT-B-NT	29346	5905339293466
AL 11W-830-MAT-SR-NT	29352	5905339293527
AL 11W-830-MAT-W-NT	29340	5905339293404
AL 11W-830-MPR-B-NT	29348	5905339293480
AL 11W-830-MPR-SR-NT	29354	5905339293541
AL 11W-830-MPR-W-NT	29342	5905339293428
AL 11W-830-RST-B-NT	29350	5905339293503
AL 11W-830-RST-SR-NT	29356	5905339293565
AL 11W-830-RST-W-NT	29344	5905339293442
AL 11W-840-MAT-B-NT	29347	5905339293473
AL 11W-840-MAT-SR-NT	29353	5905339293534
AL 11W-840-MAT-W-NT	29341	5905339293411
AL 11W-840-MPR-B-NT	29349	5905339293497
AL 11W-840-MPR-SR-NT	29355	5905339293558
AL 11W-840-MPR-W-NT	29343	5905339293435
AL 11W-840-RST-B-NT	29351	5905339293510
AL 11W-840-RST-SR-NT	29357	5905339293572
AL 11W-840-RST-W-NT	29345	5905339293459
AL 17W-830-MAT-B-NT	29382	5905339293824
AL 17W-830-MAT-SR-NT	29388	5905339293886
AL 17W-830-MAT-W-NT	29376	5905339293763
AL 17W-830-MPR-B-NT	29384	5905339293848
AL 17W-830-MPR-SR-NT	29390	5905339293909
AL 17W-830-MPR-W-NT	29378	5905339293787
AL 17W-830-RST-B-NT	29386	5905339293862
AL 17W-830-RST-SR-NT	29392	5905339293923
AL 17W-830-RST-W-NT	29380	5905339293800
AL 17W-840-MAT-B-NT	29383	5905339293831
AL 17W-840-MAT-SR-NT	29389	5905339293893
AL 17W-840-MAT-W-NT	29377	5905339293770
AL 17W-840-MPR-B-NT	29385	5905339293855
AL 17W-840-MPR-SR-NT	29391	5905339293916
AL 17W-840-MPR-W-NT	29379	5905339293794
AL 17W-840-RST-B-NT	29387	5905339293879
AL 17W-840-RST-SR-NT	29393	5905339293930
AL 17W-840-RST-W-NT	29381	5905339293817
AL 23W-830-MAT-B-NT	29418	5905339294180
AL 23W-830-MAT-SR-NT	29424	5905339294241

AL 23W-830-MAT-W-NT	29412	5905339294128
AL 23W-830-MPR-B-NT	29420	5905339294203
AL 23W-830-MPR-SR-NT	29426	5905339294265
AL 23W-830-MPR-W-NT	29414	5905339294142
AL 23W-830-RST-B-NT	29422	5905339294227
AL 23W-830-RST-SR-NT	29428	5905339294289
AL 23W-830-RST-W-NT	29416	5905339294166
AL 23W-840-MAT-B-NT	29419	5905339294197
AL 23W-840-MAT-SR-NT	29425	5905339294258
AL 23W-840-MAT-W-NT	29413	5905339294135
AL 23W-840-MPR-B-NT	29421	5905339294210
AL 23W-840-MPR-SR-NT	29427	5905339294272
AL 23W-840-MPR-W-NT	29415	5905339294159
AL 23W-840-RST-B-NT	29423	5905339294234
AL 23W-840-RST-SR-NT	29429	5905339294296
AL 23W-840-RST-W-NT	29417	5905339294173
AL 33W-830-MAT-B-NT	29454	5905339294548
AL 33W-830-MAT-SR-NT	29460	5905339294609
AL 33W-830-MAT-W-NT	29448	5905339294487
AL 33W-830-MPR-B-NT	29456	5905339294562
AL 33W-830-MPR-SR-NT	29462	5905339294623
AL 33W-830-MPR-W-NT	29450	5905339294500
AL 33W-830-RST-B-NT	29458	5905339294586
AL 33W-830-RST-SR-NT	29464	5905339294647
AL 33W-830-RST-W-NT	29452	5905339294524
AL 33W-840-MAT-B-NT	29455	5905339294555
AL 33W-840-MAT-SR-NT	29461	5905339294616
AL 33W-840-MAT-W-NT	29449	5905339294494
AL 33W-840-MPR-B-NT	29457	5905339294579
AL 33W-840-MPR-SR-NT	29463	5905339294630
AL 33W-840-MPR-W-NT	29451	5905339294517
AL 33W-840-RST-B-NT	29459	5905339294593
AL 33W-840-RST-SR-NT	29465	5905339294654
AL 33W-840-RST-W-NT	29453	5905339294531
AL 35W-830-MAT-B-NT	29490	5905339294906
AL 35W-830-MAT-SR-NT	29496	5905339294968
AL 35W-830-MAT-W-NT	29484	5905339294845
AL 35W-830-MPR-B-NT	29492	5905339294920

AL 35W-830-MPR-SR-NT	29498	5905339294982
AL 35W-830-MPR-W-NT	29486	5905339294869
AL 35W-830-RST-B-NT	29494	5905339294944
AL 35W-830-RST-SR-NT	29500	5905339295002
AL 35W-830-RST-W-NT	29488	5905339294883
AL 35W-840-MAT-B-NT	29491	5905339294913
AL 35W-840-MAT-SR-NT	29497	5905339294975
AL 35W-840-MAT-W-NT	29485	5905339294852
AL 35W-840-MPR-B-NT	29493	5905339294937
AL 35W-840-MPR-SR-NT	29499	5905339294999
AL 35W-840-MPR-W-NT	29487	5905339294876
AL 35W-840-RST-B-NT	29495	5905339294951
AL 35W-840-RST-SR-NT	29501	5905339295019
AL 35W-840-RST-W-NT	29489	5905339294890
AL 50W-830-MAT-B-NT	29526	5905339295262
AL 50W-830-MAT-SR-NT	29532	5905339295323
AL 50W-830-MAT-W-NT	29520	5905339295200
AL 50W-830-MPR-B-NT	29528	5905339295286
AL 50W-830-MPR-SR-NT	29534	5905339295347
AL 50W-830-MPR-W-NT	29522	5905339295224
AL 50W-830-RST-B-NT	29530	5905339295309
AL 50W-830-RST-SR-NT	29536	5905339295361
AL 50W-830-RST-W-NT	29524	5905339295248
AL 50W-840-MAT-B-NT	29527	5905339295279
AL 50W-840-MAT-SR-NT	29533	5905339295330
AL 50W-840-MAT-W-NT	29521	5905339295217
AL 50W-840-MPR-B-NT	29529	5905339295293
AL 50W-840-MPR-SR-NT	29535	5905339295354
AL 50W-840-MPR-W-NT	29523	5905339295231
AL 50W-840-RST-B-NT	29531	5905339295316
AL 50W-840-RST-SR-NT	29537	5905339295378
AL 50W-840-RST-W-NT	29525	5905339295255



AKCESORIA ► ACCESSORIES

ALIN CORD 1F-B	32541	5905339325419	Przyłącze zasilające do opraw i linii ALIN, 1 fazowe, czarne, 150cm Power supply terminal for ALIN luminaires and tracks, 1-phase, black, 150 cm
ALIN CORD 1F-SR	32542	5905339325426	Przyłącze zasilające do opraw i linii ALIN, 1 fazowe, srebrne, 150cm Power supply terminal for ALIN luminaires and tracks, 1-phase, silver 150 cm
ALIN CORD 1F-W	32540	5905339325402	Przyłącze zasilające do opraw i linii ALIN, 1 fazowe, białe, 150cm Power supply terminal for ALIN luminaires and tracks, 1-phase, white, 150 cm
ALIN CORD DALI 1F-B	32544	5905339325440	Przyłącze zasilające do opraw i linii ALIN, 1 fazowe, DALI, czarne, 150cm Power supply terminal for ALIN luminaires and tracks, 1-phase, DALI, black, 150 cm
ALIN CORD DALI 1F-SR	32545	5905339325457	Przyłącze zasilające do opraw i linii ALIN, 1 fazowe, DALI, srebrne, 150cm Power supply terminal for ALIN luminaires and tracks, 1-phase, DALI, silver, 150 cm
ALIN CORD DALI 1F-W	32543	5905339325433	Przyłącze zasilające do opraw i linii ALIN, 1 fazowe, DALI, białe, 150cm Power supply terminal for ALIN luminaires and tracks, 1-phase, DALI, white, 150 cm
ALIN NT GRIP	29557	5905339295576	Uchwyt ścienny do opraw ALIN, 2 szt w komplecie Wall bracket for the ALIN luminaire, 2 pcs included
ROPE-NT 150 SINGLE	07871	5905339078711	Linka stalowa (pojedyncza) do zwieszania opraw, 2 szt w komplecie Steel rope (single) for suspending fittings, 2 pcs. in a set

ALIN LED ... NT

OPRAWA LINIOWA LED WERSJA NATYNKOWA ► LINEAR LED LUMINAIRE SURFACE-MOUNTED

mm ø	11W	573mm	23W	1133mm	35W	1693mm
	17W		33W		50W	



DALI

ALD 11W-830-MAT-B-NT	29364	5905339293640
ALD 11W-830-MAT-SR-NT	29370	5905339293701
ALD 11W-830-MAT-W-NT	29358	5905339293589
ALD 11W-830-MPR-B-NT	29366	5905339293664
ALD 11W-830-MPR-SR-NT	29372	5905339293725
ALD 11W-830-MPR-W-NT	29360	5905339293602
ALD 11W-830-RST-B-NT	29368	5905339293688
ALD 11W-830-RST-SR-NT	29374	5905339293749
ALD 11W-830-RST-W-NT	29362	5905339293626
ALD 11W-840-MAT-B-NT	29365	5905339293657
ALD 11W-840-MAT-SR-NT	29371	5905339293718
ALD 11W-840-MAT-W-NT	29359	5905339293596
ALD 11W-840-MPR-B-NT	29367	5905339293671
ALD 11W-840-MPR-SR-NT	29373	5905339293732
ALD 11W-840-MPR-W-NT	29361	5905339293619
ALD 11W-840-RST-B-NT	29369	5905339293695
ALD 11W-840-RST-SR-NT	29375	5905339293756
ALD 11W-840-RST-W-NT	29363	5905339293633
ALD 17W-830-RST-B-NT	29404	5905339294043
ALD 17W-830-RST-SR-NT	29410	5905339294104
ALD 17W-830-RST-W-NT	29398	5905339293985
ALD 17W-840-RST-B-NT	29405	5905339294050
ALD 17W-840-RST-SR-NT	29411	5905339294111
ALD 17W-840-RST-W-NT	29399	5905339293992
ALD-17W-830-MAT-B-NT	29400	5905339294005
ALD-17W-830-MAT-SR-NT	29406	5905339294067
ALD-17W-830-MAT-W-NT	29394	5905339293947
ALD-17W-830-MPR-B-NT	29402	5905339294029
ALD-17W-830-MPR-SR-NT	29408	5905339294081
ALD-17W-830-MPR-W-NT	29396	5905339293961
ALD-17W-840-MAT-B-NT	29401	5905339294012
ALD-17W-840-MAT-SR-NT	29407	5905339294074
ALD-17W-840-MAT-W-NT	29395	5905339293954
ALD-17W-840-MPR-B-NT	29403	5905339294036
ALD-17W-840-MPR-SR-NT	29409	5905339294098
ALD-17W-840-MPR-W-NT	29397	5905339293978
ALD 23W-830-MAT-B-NT	29436	5905339294364
ALD 23W-830-MAT-SR-NT	29442	5905339294425
ALD 23W-830-MAT-W-NT	29430	5905339294302
ALD 23W-830-MPR-B-NT	29438	5905339294388
ALD 23W-830-MPR-SR-NT	29444	5905339294449
ALD 23W-830-MPR-W-NT	29432	5905339294326
ALD 23W-830-RST-B-NT	29440	5905339294401
ALD 23W-830-RST-SR-NT	29446	5905339294463
ALD 23W-830-RST-W-NT	29434	5905339294340

ALD 23W-840-MAT-B-NT	29437	5905339294371
ALD 23W-840-MAT-SR-NT	29443	5905339294432
ALD 23W-840-MAT-W-NT	29431	5905339294319
ALD 23W-840-MPR-B-NT	29439	5905339294395
ALD 23W-840-MPR-SR-NT	29445	5905339294456
ALD 23W-840-MPR-W-NT	29433	5905339294333
ALD 23W-840-RST-B-NT	29441	5905339294418
ALD 23W-840-RST-SR-NT	29447	5905339294470
ALD 23W-840-RST-W-NT	29435	5905339294357
ALD 33W-830-MAT-B-NT	29472	5905339294722
ALD 33W-830-MAT-SR-NT	29478	5905339294784
ALD 33W-830-MAT-W-NT	29466	5905339294661
ALD 33W-830-MPR-B-NT	29474	5905339294746
ALD 33W-830-MPR-SR-NT	29480	5905339294807
ALD 33W-830-MPR-W-NT	29468	5905339294685
ALD 33W-830-RST-B-NT	29476	5905339294760
ALD 33W-830-RST-SR-NT	29482	5905339294821
ALD 33W-830-RST-W-NT	29470	5905339294708
ALD 33W-840-MAT-B-NT	29473	5905339294739
ALD 33W-840-MAT-SR-NT	29479	5905339294791
ALD 33W-840-MAT-W-NT	29467	5905339294678
ALD 33W-840-MPR-B-NT	29475	5905339294753
ALD 33W-840-MPR-SR-NT	29481	5905339294814
ALD 33W-840-MPR-W-NT	29469	5905339294692
ALD 33W-840-RST-B-NT	29477	5905339294777
ALD 33W-840-RST-SR-NT	29483	5905339294838

ALD 33W-840-RST-W-NT	29471	5905339294715
ALD 35W-830-MAT-B-NT	29508	5905339295088
ALD 35W-830-MAT-SR-NT	29514	5905339295149
ALD 35W-830-MAT-W-NT	29502	5905339295026
ALD 35W-830-MPR-B-NT	29510	5905339295101
ALD 35W-830-MPR-SR-NT	29516	5905339295163
ALD 35W-830-MPR-W-NT	29504	5905339295040
ALD 35W-830-RST-B-NT	29512	5905339295125
ALD 35W-830-RST-SR-NT	29518	5905339295187
ALD 35W-830-RST-W-NT	29506	5905339295064
ALD 35W-840-MAT-B-NT	29509	5905339295095
ALD 35W-840-MAT-SR-NT	29515	5905339295156
ALD 35W-840-MAT-W-NT	29503	5905339295033
ALD 35W-840-MPR-B-NT	29511	5905339295118
ALD 35W-840-MPR-SR-NT	29517	5905339295170
ALD 35W-840-MPR-W-NT	29505	5905339295057
ALD 35W-840-RST-B-NT	29513	5905339295132
ALD 35W-840-RST-SR-NT	29519	5905339295194
ALD 35W-840-RST-W-NT	29507	5905339295071
ALD 50W-830-MAT-B-NT	29544	5905339295446
ALD 50W-830-MAT-SR-NT	29550	5905339295507
ALD 50W-830-MAT-W-NT	29538	5905339295385
ALD 50W-830-MPR-B-NT	29546	5905339295460
ALD 50W-830-MPR-SR-NT	29552	5905339295521
ALD 50W-830-MPR-W-NT	29540	5905339295408
ALD 50W-830-RST-B-NT	29548	5905339295484
ALD 50W-830-RST-SR-NT	29554	5905339295545
ALD 50W-830-RST-W-NT	29542	5905339295422
ALD 50W-840-MAT-B-NT	29545	5905339295453
ALD 50W-840-MAT-SR-NT	29551	5905339295514
ALD 50W-840-MAT-W-NT	29539	5905339295392
ALD 50W-840-MPR-B-NT	29547	5905339295477
ALD 50W-840-MPR-SR-NT	29553	5905339295538
ALD 50W-840-MPR-W-NT	29541	5905339295415
ALD 50W-840-RST-B-NT	29549	5905339295491
ALD 50W-840-RST-SR-NT	29555	5905339295552
ALD 50W-840-RST-W-NT	29543	5905339295439

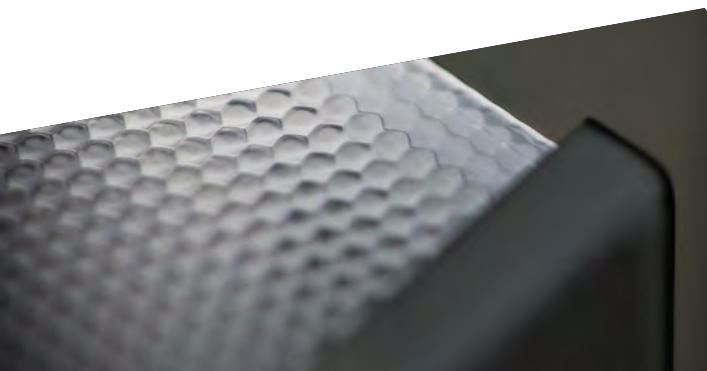

ALIN LED ... PT

OPRAWA LINIOWA LED WERSJA PODTYNKOWA ► LINEAR LED LUMINAIRE RECESSED MOUNTED

mm
A B

11W	590mm	23W	1150mm	35W	1710mm
17W		33W		50W	

AL 11W-830-MAT-B-PT	29650	5905339296504
AL 11W-830-MAT-SR-PT	29651	5905339296511
AL 11W-830-MAT-W-PT	29652	5905339296528
AL 11W-830-MPR-B-PT	29653	5905339296535
AL 11W-830-MPR-SR-PT	29654	5905339296542
AL 11W-830-MPR-W-PT	29655	5905339296559
AL 11W-840-MAT-B-PT	29656	5905339296566
AL 11W-840-MAT-SR-PT	29657	5905339296573
AL 11W-840-MAT-W-PT	29658	5905339296580
AL 11W-840-MPR-B-PT	29659	5905339296597
AL 11W-840-MPR-SR-PT	29660	5905339296603
AL 11W-840-MPR-W-PT	29661	5905339296610
AL 17W-830-MAT-B-PT	29662	5905339296627
AL 17W-830-MAT-SR-PT	29663	5905339296634
AL 17W-830-MAT-W-PT	29664	5905339296641
AL 17W-830-MPR-B-PT	29665	5905339296658
AL 17W-830-MPR-SR-PT	29666	5905339296665
AL 17W-830-MPR-W-PT	29667	5905339296672
AL 17W-840-MAT-B-PT	29668	5905339296689
AL 17W-840-MAT-SR-PT	29669	5905339296696
AL 17W-840-MAT-W-PT	29670	5905339296702
AL 17W-840-MPR-B-PT	29671	5905339296719
AL 17W-840-MPR-SR-PT	29672	5905339296726
AL 17W-840-MPR-W-PT	29673	5905339296733
AL 23W-830-MAT-B-PT	29674	5905339296740
AL 23W-830-MAT-SR-PT	29675	5905339296757
AL 23W-830-MAT-W-PT	29676	5905339296764
AL 23W-830-MPR-B-PT	29677	5905339296771
AL 23W-830-MPR-SR-PT	29678	5905339296788
AL 23W-830-MPR-W-PT	29679	5905339296795
AL 23W-840-MAT-B-PT	29680	5905339296801
AL 23W-840-MAT-SR-PT	29681	5905339296818
AL 23W-840-MAT-W-PT	29682	5905339296825
AL 23W-840-MPR-B-PT	29683	5905339296832
AL 23W-840-MPR-SR-PT	29684	5905339296849
AL 23W-840-MPR-W-PT	29685	5905339296856
AL 33W-830-MAT-B-PT	29686	5905339296863
AL 33W-830-MAT-SR-PT	29687	5905339296870
AL 33W-830-MAT-W-PT	29688	5905339296887
AL 33W-830-MPR-B-PT	29689	5905339296894
AL 33W-830-MPR-SR-PT	29690	5905339296900
AL 33W-830-MPR-W-PT	29691	5905339296917

AL 33W-840-MAT-B-PT	29692	5905339296924
AL 33W-840-MAT-SR-PT	29693	5905339296931
AL 33W-840-MAT-W-PT	29694	5905339296948
AL 33W-840-MPR-B-PT	29695	5905339296955
AL 33W-840-MPR-SR-PT	29696	5905339296962
AL 33W-840-MPR-W-PT	29697	5905339296979
AL 35W-830-MAT-B-PT	29698	5905339296986
AL 35W-830-MAT-SR-PT	29699	5905339296993
AL 35W-830-MAT-W-PT	29700	5905339297006
AL 35W-830-MPR-B-PT	29701	5905339297013
AL 35W-830-MPR-SR-PT	29702	5905339297020
AL 35W-830-MPR-W-PT	29703	5905339297037
AL 35W-840-MAT-B-PT	29704	5905339297044
AL 35W-840-MAT-SR-PT	29705	5905339297051
AL 35W-840-MAT-W-PT	29706	5905339297068

AL 35W-840-MPR-B-PT	29707	5905339297075
AL 35W-840-MPR-SR-PT	29708	5905339297082
AL 35W-840-MPR-W-PT	29709	5905339297099
AL 50W-830-MAT-B-PT	29710	5905339297105
AL 50W-830-MAT-SR-PT	29711	5905339297112
AL 50W-830-MAT-W-PT	29712	5905339297129
AL 50W-830-MPR-B-PT	29713	5905339297136
AL 50W-830-MPR-SR-PT	29714	5905339297143
AL 50W-830-MPR-W-PT	29715	5905339297150
AL 50W-840-MAT-B-PT	29716	5905339297167
AL 50W-840-MAT-SR-PT	29717	5905339297174
AL 50W-840-MAT-W-PT	29718	5905339297181
AL 50W-840-MPR-B-PT	29719	5905339297198
AL 50W-840-MPR-SR-PT	29720	5905339297204
AL 50W-840-MPR-W-PT	29721	5905339297211



ALIN LED ... PT

OPRAWA LINIOWA LED WERSJA PODTYNKOWA ► LINEAR LED LUMINAIRE RECESSED MOUNTED

mm φ	11W	590mm	23W	1150mm	35W	1710mm
	17W		33W		50W	



DALI

ALD 11W-830-MAT-B-PT	29722	5905339297228
ALD 11W-830-MAT-SR-PT	29723	5905339297235
ALD 11W-830-MAT-W-PT	29724	5905339297242
ALD 11W-830-MPR-B-PT	29725	5905339297259
ALD 11W-830-MPR-SR-PT	29726	5905339297266
ALD 11W-830-MPR-W-PT	29727	5905339297273
ALD 11W-840-MAT-B-PT	29728	5905339297280
ALD 11W-840-MAT-SR-PT	29729	5905339297297
ALD 11W-840-MAT-W-PT	29730	5905339297303
ALD 11W-840-MPR-B-PT	29731	5905339297310
ALD 11W-840-MPR-SR-PT	29732	5905339297327
ALD 11W-840-MPR-W-PT	29733	5905339297334
ALD-17W-830-MAT-B-PT	29782	5905339297822
ALD-17W-830-MAT-SR-PT	29783	5905339297839



ALD-17W-830-MAT-W-PT	29784	5905339297846
ALD-17W-830-MPR-B-PT	29785	5905339297853
ALD-17W-830-MPR-SR-PT	29786	5905339297860
ALD-17W-830-MPR-W-PT	29787	5905339297877
ALD-17W-840-MAT-B-PT	29788	5905339297884
ALD-17W-840-MAT-SR-PT	29789	5905339297891
ALD-17W-840-MAT-W-PT	29790	5905339297907
ALD-17W-840-MPR-B-PT	29791	5905339297914
ALD-17W-840-MPR-SR-PT	29792	5905339297921
ALD-17W-840-MPR-W-PT	29793	5905339297938
ALD 23W-830-MAT-B-PT	29734	5905339297341
ALD 23W-830-MAT-SR-PT	29735	5905339297358
ALD 23W-830-MAT-W-PT	29736	5905339297365
ALD 23W-830-MPR-B-PT	29737	5905339297372
ALD 23W-830-MPR-SR-PT	29738	5905339297389
ALD 23W-830-MPR-W-PT	29739	5905339297396
ALD 23W-840-MAT-B-PT	29740	5905339297402
ALD 23W-840-MAT-SR-PT	29741	5905339297419
ALD 23W-840-MAT-W-PT	29742	5905339297426
ALD 23W-840-MPR-B-PT	29743	5905339297433
ALD 23W-840-MPR-SR-PT	29744	5905339297440
ALD 23W-840-MPR-W-PT	29745	5905339297457
ALD 33W-830-MAT-B-PT	29746	5905339297464
ALD 33W-830-MAT-SR-PT	29747	5905339297471
ALD 33W-830-MAT-W-PT	29748	5905339297488
ALD 33W-830-MPR-B-PT	29749	5905339297495
ALD 33W-830-MPR-SR-PT	29750	5905339297501
ALD 33W-830-MPR-W-PT	29751	5905339297518
ALD 33W-835-MPR-W-PT	28436	5905339284365
ALD 33W-840-MAT-B-PT	29752	5905339297525
ALD 33W-840-MAT-SR-PT	29753	5905339297532
ALD 33W-840-MAT-W-PT	29754	5905339297549
ALD 33W-840-MPR-B-PT	29755	5905339297556

ALD 33W-840-MPR-SR-PT	29756	5905339297563
ALD 33W-840-MPR-W-PT	29757	5905339297570
ALD 35W-830-MAT-B-PT	29758	5905339297587
ALD 35W-830-MAT-SR-PT	29759	5905339297594
ALD 35W-830-MAT-W-PT	29760	5905339297600
ALD 35W-830-MPR-B-PT	29761	5905339297617
ALD 35W-830-MPR-SR-PT	29762	5905339297624
ALD 35W-830-MPR-W-PT	29763	5905339297631
ALD 35W-840-MAT-B-PT	29764	5905339297648
ALD 35W-840-MAT-SR-PT	29765	5905339297655
ALD 35W-840-MAT-W-PT	29766	5905339297662
ALD 35W-840-MPR-B-PT	29767	5905339297679
ALD 35W-840-MPR-SR-PT	29768	5905339297686
ALD 35W-840-MPR-W-PT	29769	5905339297693
ALD 50W-830-MAT-B-PT	29770	5905339297709
ALD 50W-830-MAT-SR-PT	29771	5905339297716
ALD 50W-830-MAT-W-PT	29772	5905339297723
ALD 50W-830-MPR-B-PT	29773	5905339297730
ALD 50W-830-MPR-SR-PT	29774	5905339297747
ALD 50W-830-MPR-W-PT	29775	5905339297754
ALD 50W-840-MAT-B-PT	29776	5905339297761
ALD 50W-840-MAT-SR-PT	29777	5905339297778
ALD 50W-840-MAT-W-PT	29778	5905339297785
ALD 50W-840-MPR-B-PT	29779	5905339297792
ALD 50W-840-MPR-SR-PT	29780	5905339297808
ALD 50W-840-MPR-W-PT	29781	5905339297815

ALIN LED LINE

OPRAWA LINIOWA LED ► LINEAR LIGHTING FIXTURES



Kanlux ALIN LED LINE to innowacyjny system oświetleniowy stworzony w oparciu o idealnie dopracowane oprawy Kanlux ALIN LED. Rozwiązanie to pozwala na stworzenie długich linii świetlnych o prostych lub niestandardowych kształtach. Pełne dopasowanie do konkretnej inwestycji daje możliwości osiągnięcia niepowtarzalnego efektu przy każdej realizacji z użyciem Kanlux ALIN LED LINE.



5 lat Gwarancji na warunkach oświadczenia gwarancyjnego, dostępnego na stronie internetowej: www.kanlux.com



Kanlux ALIN LED LINE is an innovative lighting system created based on perfectly prepared Kanlux ALIN LED luminaires. This solution allows for creating long light lines with straight or custom shapes. Full adaptation to the specific investment enables creation of a unique effect in each project using Kanlux ALIN LED LINE.



5 years Warranty under the terms of the warranty statement, available on our website: www.kanlux.com

CONFIGURATOR



Wyprodukujemy dla Ciebie oprawę idealną. Stwórz ją z pomocą naszego konfiguratora.

We will produce a perfect luminaire for you. Create it with our configurator.

NIEOGRANICZONA DŁUGOŚĆ
LINII ŚWIETLNEJ
UNLIMITED LENGTH
OF LIGHT LINE

LF

LM

CZTERY WERSJE
MONTAŻU
FOUR VERSIONS
OF MOUNTING

TRZY KOLORY
OBUDOWY
THREE HOUSING
COLORS

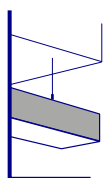

ZWISZANA
SUSPENDED
MOUNTED

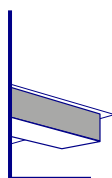

NATYNKOWA
SURFACE
MOUNTED

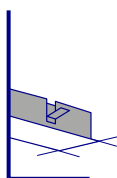

PODTYNKOWA
RECESSED
MOUNTED

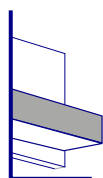

DO NADBUDOWANIA
NA ŚCIANIE
WALL MOUNTED



BIAŁY
WHITE



CZARNY
BLACK



SREBNY
SILVER

LEGENDA ► KEY

LF	element początkowy / first component
LM	element środkowy / middle component
LL	element końcowy / last component
LFD	element początkowy DALI / first component DALI
LMD	element środkowy DALI / middle component DALI
LLD	element końcowy DALI / last component DALI
830	Ra ≥ 80 3000K
840	Ra ≥ 80 4000K
MAT	klosz matowy / matt lampshade
MPRM	klosz mikropryzmatyczny / microprismatic lampshade
W	kolor obudowy: biały / housing colour: white
B	kolor obudowy: czarny / housing colour: black
SR	kolor obudowy: srebrny / housing colour: silver
PT	wersja podtynkowa / recessed mounted
NT	wersja natynkowa / surface-mounted
ALIN +CORD +ROPE	wersja wisząca / suspended mounted
ALIN +ALIN NT GRIP	wersja do nadbudowania na ścianie / wall mounted

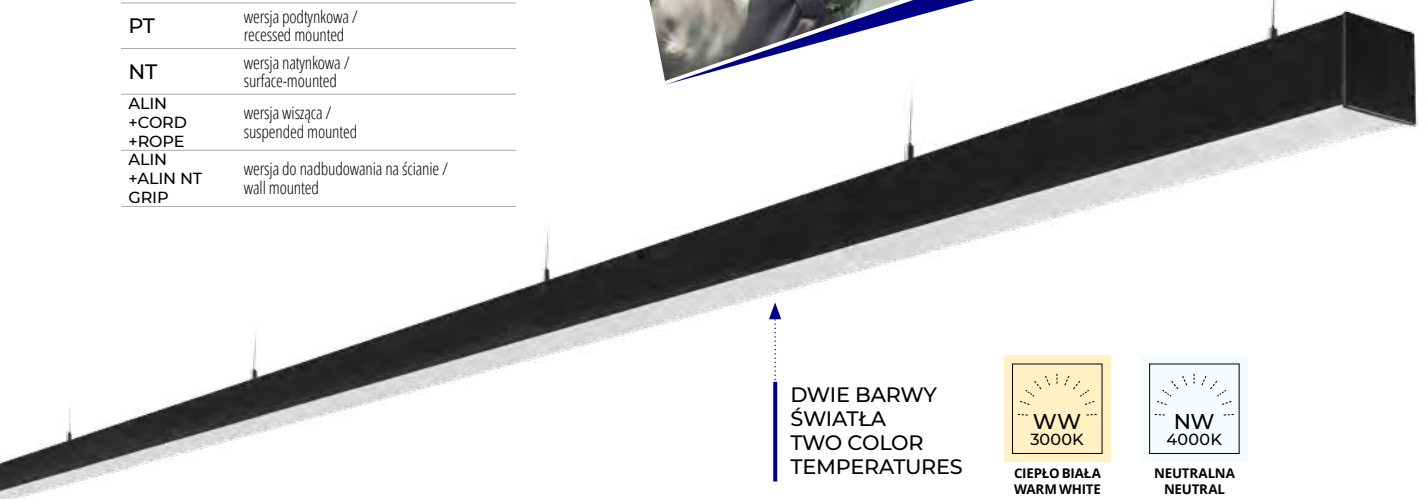

DWIE BARWY ŚWIATŁA
TWO COLOR TEMPERATURES

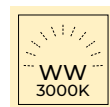

CIEPŁO BIAŁA
WARM WHITE

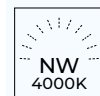

NEUTRALNA
NEUTRAL

LM

LL

DWA RODZAJE DYFUZORA
TWO TYPES OF DIFFUSER

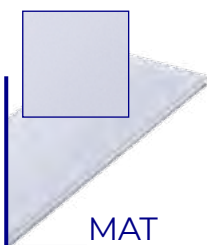

MATOWY
MATT

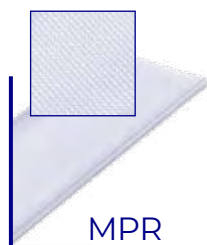

MIKROPRYZMATYCZNY
MICROPRISMATIC

OPCJONALNIE
STEROWANIE DALI
DALI LED DRIVER AVAILABLE
AS AN OPTION

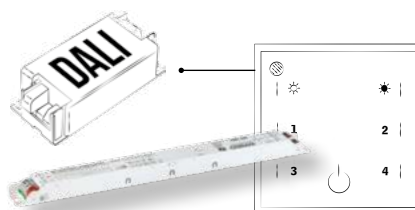

ZASILACZ
MARKI OSRAM
POWER SUPPLY
BY OSRAM

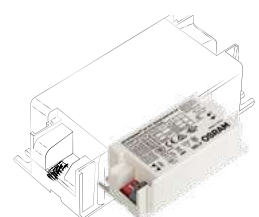

ALIN LED LINE

OPRAWA LINIOWA LED WERSJA WISZĄCA ► LINEAR LED LUMINAIRE SUSPENDED-MOUNTED

LF 23W-840-MAT-W	29956	5905339299567
LF 23W-840-MPR-W	29959	5905339299598
LF 23W-840-MAT-B	29954	5905339299543
LF 23W-840-MPR-B	29957	5905339299574
LF 23W-840-MAT-SR	29955	5905339299550
LF 23W-840-MPR-SR	29958	5905339299581
LM 23W-840-MAT-W	29980	5905339299802
LM 23W-840-MPR-W	29983	5905339299833
LM 23W-840-MAT-B	29978	5905339299789
LM 23W-840-MPR-B	29981	5905339299819
LM 23W-840-MAT-SR	29979	5905339299796
LM 23W-840-MPR-SR	29982	5905339299826
LL 23W-840-MAT-W	32004	5905339320049
LL 23W-840-MPR-W	32007	5905339320070
LL 23W-840-MAT-B	32002	5905339320025
LL 23W-840-MPR-B	32005	5905339320056
LL 23W-840-MAT-SR	32003	5905339320032
LL 23W-840-MPR-SR	32006	5905339320063
LF 23W-830-MAT-W	29950	5905339299505
LF 23W-830-MPR-W	29953	5905339299536
LF 23W-830-MAT-B	29948	5905339299482
LF 23W-830-MPR-B	29951	5905339299512
LF 23W-830-MAT-SR	29949	5905339299499
LF 23W-830-MPR-SR	29952	5905339299529
LM 23W-830-MAT-W	29974	5905339299741
LM 23W-830-MPR-W	29977	5905339299772
LM 23W-830-MAT-B	29972	5905339299727
LM 23W-830-MPR-B	29975	5905339299758
LM 23W-830-MAT-SR	29973	5905339299734
LM 23W-830-MPR-SR	29976	5905339299765
LL 23W-830-MAT-W	29998	5905339299987
LL 23W-830-MPR-W	32001	5905339320018
LL 23W-830-MAT-B	29996	5905339299963
LL 23W-830-MPR-B	29999	5905339299994
LL 23W-830-MAT-SR	29997	5905339299970
LL 23W-830-MPR-SR	32000	5905339320001
LF 33W-830-MAT-W	32022	5905339320223
LF 33W-830-MPR-W	32025	5905339320254
LF 33W-830-MAT-B	32020	5905339320209
LF 33W-830-MPR-B	32023	5905339320230
LF 33W-830-MAT-SR	32021	5905339320216
LF 33W-830-MPR-SR	32024	5905339320247
LM 33W-830-MAT-W	32046	5905339320469
LM 33W-830-MPR-W	32049	5905339320490
LM 33W-830-MAT-B	32044	5905339320445
LM 33W-830-MPR-B	32047	5905339320476
LM 33W-830-MAT-SR	32045	5905339320452
LM 33W-830-MPR-SR	32048	5905339320483

LL 33W-830-MAT-W	32070	5905339320704
LL 33W-830-MPR-W	32073	5905339320735
LL 33W-830-MAT-B	32068	5905339320681
LL 33W-830-MPR-B	32071	5905339320711
LL 33W-830-MAT-SR	32069	5905339320698
LL 33W-830-MPR-SR	32072	5905339320728
LF 33W-840-MAT-W	32028	5905339320285
LF 33W-840-MPR-W	32031	5905339320315
LF 33W-840-MAT-B	32026	5905339320261
LF 33W-840-MPR-B	32029	5905339320292
LF 33W-840-MAT-SR	32027	5905339320278
LF 33W-840-MPR-SR	32030	5905339320308
LM 33W-840-MAT-W	32052	5905339320520
LM 33W-840-MPR-W	32055	5905339320551
LM 33W-840-MAT-B	32050	5905339320506
LM 33W-840-MPR-B	32053	5905339320537
LM 33W-840-MAT-SR	32051	5905339320513
LM 33W-840-MPR-SR	32054	5905339320544
LL 33W-840-MAT-W	32076	5905339320766
LL 33W-840-MPR-W	32079	5905339320797
LL 33W-840-MAT-B	32074	5905339320742
LL 33W-840-MPR-B	32077	5905339320773
LL 33W-840-MAT-SR	32075	5905339320759
LL 33W-840-MPR-SR	32078	5905339320780

DALI

LFD 23W-840-MAT-W	29968	5905339299680
LFD 23W-840-MPR-W	29971	5905339299710
LFD 23W-840-MAT-B	29966	5905339299666
LFD 23W-840-MPR-B	29969	5905339299697
LFD 23W-840-MAT-SR	29967	5905339299673
LFD 23W-840-MPR-SR	29970	5905339299703
LMD 23W-840-MAT-W	29992	5905339299925
LMD 23W-840-MPR-W	29995	5905339299956
LMD 23W-840-MAT-B	29990	5905339299901
LMD 23W-840-MPR-B	29993	5905339299932
LMD 23W-840-MAT-SR	29991	5905339299918
LMD 23W-840-MPR-SR	29994	5905339299949
LLD 23W-840-MAT-W	32016	5905339320162
LLD 23W-840-MPR-W	32019	5905339320193
LLD 23W-840-MAT-B	32014	5905339320148
LLD 23W-840-MPR-B	32017	5905339320175
LLD 23W-840-MAT-SR	32015	5905339320159
LLD 23W-840-MPR-SR	32018	5905339320186
LFD 23W-830-MAT-W	29962	5905339299628
LFD 23W-830-MPR-W	29965	5905339299659
LFD 23W-830-MAT-B	29960	5905339299604
LFD 23W-830-MPR-B	29963	5905339299635
LFD 23W-830-MAT-SR	29961	5905339299611

LFD 23W-830-MPR-SR	29964	5905339299642
LMD 23W-830-MAT-W	29986	5905339299864
LMD 23W-830-MPR-W	29989	5905339299895
LMD 23W-830-MAT-B	29984	5905339299840
LMD 23W-830-MPR-B	29987	5905339299871
LMD 23W-830-MAT-SR	29985	5905339299857
LMD 23W-830-MPR-SR	29988	5905339299888
LLD 23W-830-MAT-W	32010	5905339320100
LLD 23W-830-MPR-W	32013	5905339320131
LLD 23W-830-MAT-B	32008	5905339320087
LLD 23W-830-MPR-B	32011	5905339320117
LLD 23W-830-MAT-SR	32009	5905339320094
LLD 23W-830-MPR-SR	32012	5905339320124
LFD 33W-830-MAT-W	32034	5905339320451
LFD 33W-830-MPR-W	32037	5905339320377
LFD 33W-830-MAT-B	32032	5905339320322
LFD 33W-830-MPR-B	32035	5905339320353
LFD 33W-830-MAT-SR	32033	5905339320339
LFD 33W-830-MPR-SR	32036	5905339320360
LMD 33W-830-MAT-W	32058	5905339320582
LMD 33W-830-MPR-W	32061	5905339320612
LMD 33W-830-MAT-B	32056	5905339320568
LMD 33W-830-MPR-B	32059	5905339320599
LMD 33W-830-MAT-SR	32057	5905339320575
LMD 33W-830-MPR-SR	32060	5905339320605
LLD 33W-830-MAT-W	32082	5905339320827
LLD 33W-830-MPR-W	32085	5905339320858
LLD 33W-830-MAT-B	32080	5905339320803
LLD 33W-830-MPR-B	32083	5905339320834
LLD 33W-830-MAT-SR	32081	5905339320810
LLD 33W-830-MPR-SR	32084	5905339320841
LFD 33W-840-MAT-W	32040	5905339320407
LFD 33W-840-MPR-W	32043	5905339320438
LFD 33W-840-MAT-B	32038	5905339320384
LFD 33W-840-MPR-B	32041	5905339320414
LFD 33W-840-MAT-SR	32039	5905339320391
LFD 33W-840-MPR-SR	32042	5905339320421
LMD 33W-840-MAT-W	32064	5905339320643
LMD 33W-840-MPR-W	32067	5905339320674
LMD 33W-840-MAT-B	32062	5905339320629
LMD 33W-840-MPR-B	32065	5905339320650
LMD 33W-840-MAT-SR	32063	5905339320636
LMD 33W-840-MPR-SR	32066	5905339320667
LLD 33W-840-MAT-W	32088	5905339320889
LLD 33W-840-MPR-W	32091	5905339320919
LLD 33W-840-MAT-B	32086	5905339320865
LLD 33W-840-MPR-B	32089	5905339320896
LLD 33W-840-MAT-SR	32087	5905339320872
LLD 33W-840-MPR-SR	32090	5905339320902

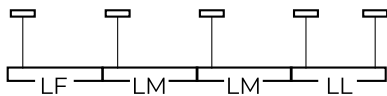

ALIN CORD...-B



ALIN CORD...-SR



ALIN CORD...-W



ROPE-NT 150 SINGLE

AKCESORIA ► ACCESSORIES

ALIN CORD 1F-B	32541	5905339325419	Przyłącze zasilające do opraw i linii ALIN, 1 fazowe, czarne, 150cm Power supply terminal for ALIN luminaires and tracks, 1-phase, black, 150 cm
ALIN CORD 1F-SR	32542	5905339325426	Przyłącze zasilające do opraw i linii ALIN, 1 fazowe, srebrne, 150cm Power supply terminal for ALIN luminaires and tracks, 1-phase, silver 150 cm
ALIN CORD 1F-W	32540	5905339325402	Przyłącze zasilające do opraw i linii ALIN, 1 fazowe, białe, 150cm Power supply terminal for ALIN luminaires and tracks, 1-phase, white, 150 cm
ALIN CORD DALI 1F-B	32544	5905339325440	Przyłącze zasilające do opraw i linii ALIN, 1 fazowe, DALI, czarne, 150cm Power supply terminal for ALIN luminaires and tracks, 1-phase, DALI, black, 150 cm
ALIN CORD DALI 1F-SR	32545	5905339325457	Przyłącze zasilające do opraw i linii ALIN, 1 fazowe, DALI, srebrne, 150cm Power supply terminal for ALIN luminaires and tracks, 1-phase, DALI, silver, 150 cm
ALIN CORD DALI 1F-W	32543	5905339325433	Przyłącze zasilające do opraw i linii ALIN, 1 fazowe, DALI białe, 150cm Power supply terminal for ALIN luminaires and tracks, 1-phase, DALI, white, 150 cm
ROPE-NT 150 SINGLE	07871	5905339078711	Linka stalowa (pojedyncza) do zwieszania opraw, 2 szt w komplecie Steel rope (single) for suspending fittings, 2 pcs. in a set

ALIN LED LINE

OPRAWA LINIOWA LED WERSJA NATYNKOWA ► LINEAR LED LUMINAIRE SURFACE-MOUNTED



LF 23W-830-MAT-B-NT	32140	5905339321404
LF 23W-830-MAT-SR-NT	32141	5905339321411
LF 23W-830-MAT-W-NT	32142	5905339321428
LF 23W-830-MPR-B-NT	32143	5905339321435
LF 23W-830-MPR-SR-NT	32144	5905339321442
LF 23W-830-MPR-W-NT	32145	5905339321459
LF 23W-840-MAT-B-NT	32146	5905339321466
LF 23W-840-MAT-SR-NT	32147	5905339321473
LF 23W-840-MAT-W-NT	32148	5905339321480
LF 23W-840-MPR-B-NT	32149	5905339321497
LF 23W-840-MPR-SR-NT	32150	5905339321503
LF 23W-840-MPR-W-NT	32151	5905339321510
LF 33W-830-MAT-B-NT	32212	5905339322128
LF 33W-830-MAT-SR-NT	32213	5905339322135
LF 33W-830-MAT-W-NT	32214	5905339322142
LF 33W-830-MPR-B-NT	32215	5905339322159
LF 33W-830-MPR-SR-NT	32216	5905339322166
LF 33W-830-MPR-W-NT	32217	5905339322173
LF 33W-840-MAT-B-NT	32218	5905339322180
LF 33W-840-MAT-SR-NT	32219	5905339322197
LF 33W-840-MAT-W-NT	32220	5905339322203
LF 33W-840-MPR-B-NT	32221	5905339322210
LF 33W-840-MPR-SR-NT	32222	5905339322227
LF 33W-840-MPR-W-NT	32223	5905339322234
LL 23W-830-MAT-B-NT	32188	5905339321886
LL 23W-830-MAT-SR-NT	32189	5905339321893
LL 23W-830-MAT-W-NT	32190	5905339321909
LL 23W-830-MPR-B-NT	32191	5905339321916
LL 23W-830-MPR-SR-NT	32192	5905339321923
LL 23W-830-MPR-W-NT	32193	5905339321930
LL 23W-840-MAT-B-NT	32194	5905339321947
LL 23W-840-MAT-SR-NT	32195	5905339321954
LL 23W-840-MAT-W-NT	32196	5905339321961
LL 23W-840-MPR-B-NT	32197	5905339321978

LL 23W-840-MPR-SR-NT	32198	5905339321985
LL 23W-840-MPR-W-NT	32199	5905339321992
LL 33W-830-MAT-B-NT	32260	5905339322609
LL 33W-830-MAT-SR-NT	32261	5905339322616
LL 33W-830-MAT-W-NT	32262	5905339322623
LL 33W-830-MPR-B-NT	32263	5905339322630
LL 33W-830-MPR-SR-NT	32264	5905339322647
LL 33W-830-MPR-W-NT	32265	5905339322654
LL 33W-840-MAT-B-NT	32266	5905339322661
LL 33W-840-MAT-SR-NT	32267	5905339322678
LL 33W-840-MAT-W-NT	32268	5905339322685
LL 33W-840-MPR-B-NT	32269	5905339322692
LL 33W-840-MPR-SR-NT	32270	5905339322708
LL 33W-840-MPR-W-NT	32271	5905339322715
LM 23W-830-MAT-B-NT	32164	5905339321640
LM 23W-830-MAT-SR-NT	32165	5905339321657
LM 23W-830-MAT-W-NT	32166	5905339321664
LM 23W-830-MPR-B-NT	32167	5905339321671
LM 23W-830-MPR-SR-NT	32168	5905339321688
LM 23W-830-MPR-W-NT	32169	5905339321695
LM 23W-840-MAT-B-NT	32170	5905339321701
LM 23W-840-MAT-SR-NT	32171	5905339321718
LM 23W-840-MAT-W-NT	32172	5905339321725
LM 23W-840-MPR-B-NT	32173	5905339321732
LM 23W-840-MPR-SR-NT	32174	5905339321749
LM 23W-840-MPR-W-NT	32175	5905339321756
LM 33W-830-MAT-B-NT	32236	5905339322364
LM 33W-830-MAT-SR-NT	32237	5905339322371
LM 33W-830-MAT-W-NT	32238	5905339322388
LM 33W-830-MPR-B-NT	32239	5905339322395
LM 33W-830-MPR-SR-NT	32240	5905339322401

LM 33W-830-MPR-W-NT	32241	5905339322418
LM 33W-840-MAT-B-NT	32242	5905339322425
LM 33W-840-MAT-SR-NT	32243	5905339322432
LM 33W-840-MAT-W-NT	32244	5905339322449
LM 33W-840-MPR-B-NT	32245	5905339322456
LM 33W-840-MPR-SR-NT	32246	5905339322463
LM 33W-840-MPR-W-NT	32247	5905339322470

DALI

LFD 23W-830-MAT-B-NT	32152	5905339321527
LFD 23W-830-MAT-SR-NT	32153	5905339321534
LFD 23W-830-MAT-W-NT	32154	5905339321541
LFD 23W-830-MPR-B-NT	32155	5905339321558
LFD 23W-830-MPR-SR-NT	32156	5905339321565
LFD 23W-830-MPR-W-NT	32157	5905339321572
LFD 23W-840-MAT-B-NT	32158	5905339321589
LFD 23W-840-MAT-SR-NT	32159	5905339321596
LFD 23W-840-MAT-W-NT	32160	5905339321602
LFD 23W-840-MPR-B-NT	32161	5905339321619
LFD 23W-840-MPR-SR-NT	32162	5905339321626
LFD 23W-840-MPR-W-NT	32163	5905339321633
LFD 33W-830-MAT-B-NT	32224	5905339322241
LFD 33W-830-MAT-SR-NT	32225	5905339322258
LFD 33W-830-MAT-W-NT	32226	5905339322265
LFD 33W-830-MPR-B-NT	32227	5905339322272
LFD 33W-830-MPR-SR-NT	32228	5905339322289
LFD 33W-830-MPR-W-NT	32229	5905339322296
LFD 33W-840-MAT-B-NT	32230	5905339322302
LFD 33W-840-MAT-SR-NT	32231	5905339322319
LFD 33W-840-MAT-W-NT	32232	5905339322326
LFD 33W-840-MPR-B-NT	32233	5905339322333
LFD 33W-840-MPR-SR-NT	32234	5905339322340

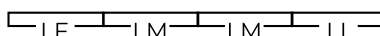

ALIN NT GRIP

AKCESORIA ► ACCESSORIES

ALIN NT GRIP	29557	5905339295576
--------------	--------------	---------------

Uchwyt ścienny do oprawy ALIN, 2 szt w komplecie | Wall bracket for the ALIN luminaire, 2 pcs included

ALIN LED LINE

OPRAWA LINIOWA LED WERSJA NATYNKOWA ► LINEAR LED LUMINAIRE SURFACE-MOUNTED

LFD 33W-840-MPR-W-NT	32235	5905339322357
LLD 23W-830-MAT-B-NT	32200	5905339322005
LLD 23W-830-MAT-SR-NT	32201	5905339322012
LLD 23W-830-MAT-W-NT	32202	5905339322029
LLD 23W-830-MPR-B-NT	32203	5905339322036
LLD 23W-830-MPR-SR-NT	32204	5905339322043
LLD 23W-830-MPR-W-NT	32205	5905339322050
LLD 23W-840-MAT-B-NT	32206	5905339322067
LLD 23W-840-MAT-SR-NT	32207	5905339322074
LLD 23W-840-MAT-W-NT	32208	5905339322081
LLD 23W-840-MPR-B-NT	32209	5905339322098
LLD 23W-840-MPR-SR-NT	32210	5905339322104
LLD 23W-840-MPR-W-NT	32211	5905339322111
LLD 33W-830-MAT-B-NT	32272	5905339322722
LLD 33W-830-MAT-SR-NT	32273	5905339322739
LLD 33W-830-MAT-W-NT	32274	5905339322746
LLD 33W-830-MPR-B-NT	32275	5905339322753
LLD 33W-830-MPR-SR-NT	32276	5905339322760
LLD 33W-830-MPR-W-NT	32277	5905339322777
LLD 33W-840-MAT-B-NT	32278	5905339322784
LLD 33W-840-MAT-SR-NT	32279	5905339322791
LLD 33W-840-MAT-W-NT	32280	5905339322807
LLD 33W-840-MPR-B-NT	32281	5905339322814
LLD 33W-840-MPR-SR-NT	32282	5905339322821
LLD 33W-840-MPR-W-NT	32283	5905339322838
LMD 23W-830-MAT-B-NT	32176	5905339321763
LMD 23W-830-MAT-SR-NT	32177	5905339321770
LMD 23W-830-MAT-W-NT	32178	5905339321787
LMD 23W-830-MPR-B-NT	32179	5905339321794
LMD 23W-830-MPR-SR-NT	32180	5905339321800
LMD 23W-830-MPR-W-NT	32181	5905339321817

LMD 23W-840-MAT-B-NT	32182	5905339321824
LMD 23W-840-MAT-SR-NT	32183	5905339321831
LMD 23W-840-MAT-W-NT	32184	5905339321848
LMD 23W-840-MPR-B-NT	32185	5905339321855
LMD 23W-840-MPR-SR-NT	32186	5905339321862
LMD 23W-840-MPR-W-NT	32187	5905339321879
LMD 33W-830-MAT-B-NT	32248	5905339322487
LMD 33W-830-MAT-SR-NT	32249	5905339322494
LMD 33W-830-MAT-W-NT	32250	5905339322500

LMD 33W-830-MPR-B-NT	32251	5905339322517
LMD 33W-830-MPR-SR-NT	32252	5905339322524
LMD 33W-830-MPR-W-NT	32253	5905339322531
LMD 33W-840-MAT-B-NT	32254	5905339322548
LMD 33W-840-MAT-SR-NT	32255	5905339322555
LMD 33W-840-MAT-W-NT	32256	5905339322562
LMD 33W-840-MPR-B-NT	32257	5905339322579
LMD 33W-840-MPR-SR-NT	32258	5905339322586
LMD 33W-840-MPR-W-NT	32259	5905339322593

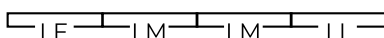

ALIN NT GRIP

AKCESORIA ► ACCESSORIES

ALIN NT GRIP	29557	5905339295576
--------------	--------------	---------------

Uchwyt ścienny do oprawy ALIN, 2 szt w komplecie | Wall bracket for the ALIN luminaire, 2 pcs included



ALIN LED LINE ... PT

OPRAWA LINIOWA LED WERSJA PODTYNKOWA ► LINEAR LED LUMINAIRE RECESSED MOUNTED



LF 23W-830-MAT-B-PT	32332	5905339323323
LF 23W-830-MAT-SR-PT	32333	5905339323330
LF 23W-830-MAT-W-PT	32334	5905339323347
LF 23W-830-MPR-B-PT	32335	5905339323354
LF 23W-830-MPR-SR-PT	32336	5905339323361
LF 23W-830-MPR-W-PT	32337	5905339323378
LF 23W-840-MAT-B-PT	32338	5905339323385
LF 23W-840-MAT-SR-PT	32339	5905339323392
LF 23W-840-MAT-W-PT	32340	5905339323408
LF 23W-840-MPR-B-PT	32341	5905339323415
LF 23W-840-MPR-SR-PT	32342	5905339323422
LF 23W-840-MPR-W-PT	32343	5905339323439
LM 23W-830-MAT-B-PT	32356	5905339323569
LM 23W-830-MAT-SR-PT	32357	5905339323576
LM 23W-830-MAT-W-PT	32358	5905339323583
LM 23W-830-MPR-B-PT	32359	5905339323590
LM 23W-830-MPR-SR-PT	32360	5905339323606
LM 23W-830-MPR-W-PT	32361	5905339323613
LM 23W-840-MAT-B-PT	32362	5905339323620
LM 23W-840-MAT-SR-PT	32363	5905339323637
LM 23W-840-MAT-W-PT	32364	5905339323644
LM 23W-840-MPR-B-PT	32365	5905339323651
LM 23W-840-MPR-SR-PT	32366	5905339323668
LM 23W-840-MPR-W-PT	32367	5905339323675
LL 23W-830-MAT-B-PT	32380	5905339323804
LL 23W-830-MAT-SR-PT	32381	5905339323811
LL 23W-830-MAT-W-PT	32382	5905339323828
LL 23W-830-MPR-B-PT	32383	5905339323835
LL 23W-830-MPR-SR-PT	32384	5905339323842
LL 23W-830-MPR-W-PT	32385	5905339323859
LL 23W-840-MAT-B-PT	32386	5905339323866
LL 23W-840-MAT-SR-PT	32387	5905339323873
LL 23W-840-MAT-W-PT	32388	5905339323880
LL 23W-840-MPR-B-PT	32389	5905339323897
LL 23W-840-MPR-SR-PT	32390	5905339323903
LL 23W-840-MPR-W-PT	32391	5905339323910
LF 33W-830-MAT-B-PT	32404	5905339324047
LF 33W-830-MAT-SR-PT	32405	5905339324054
LF 33W-830-MAT-W-PT	32406	5905339324061
LF 33W-830-MPR-B-PT	32407	5905339324078
LF 33W-830-MPR-SR-PT	32408	5905339324085
LF 33W-830-MPR-W-PT	32409	5905339324092
LF 33W-840-MAT-B-PT	32410	5905339324108
LF 33W-840-MAT-SR-PT	32411	5905339324115
LF 33W-840-MAT-W-PT	32412	5905339324122
LF 33W-840-MPR-B-PT	32413	5905339324139
LF 33W-840-MPR-SR-PT	32414	5905339324146
LF 33W-840-MPR-W-PT	32415	5905339324153
LM 33W-830-MAT-B-PT	32428	5905339324283
LM 33W-830-MAT-SR-PT	32429	5905339324290
LM 33W-830-MAT-W-PT	32430	5905339324306
LM 33W-830-MPR-B-PT	32431	5905339324313
LM 33W-830-MPR-SR-PT	32432	5905339324320
LM 33W-830-MPR-W-PT	32433	5905339324337
LM 33W-840-MAT-B-PT	32434	5905339324344
LM 33W-840-MAT-SR-PT	32435	5905339324351
LM 33W-840-MAT-W-PT	32436	5905339324368

LM 33W-840-MPR-B-PT	32437	5905339324375
LM 33W-840-MPR-SR-PT	32438	5905339324382
LM 33W-840-MPR-W-PT	32439	5905339324399
LL 33W-830-MAT-B-PT	32452	5905339324528
LL 33W-830-MAT-SR-PT	32453	5905339324535
LL 33W-830-MAT-W-PT	32454	5905339324542
LL 33W-830-MPR-B-PT	32455	5905339324559
LL 33W-830-MPR-SR-PT	32456	5905339324566
LL 33W-830-MPR-W-PT	32457	5905339324573
LL 33W-840-MAT-B-PT	32458	5905339324580
LL 33W-840-MAT-SR-PT	32459	5905339324597
LL 33W-840-MAT-W-PT	32460	5905339324603
LL 33W-840-MPR-B-PT	32461	5905339324610
LL 33W-840-MPR-SR-PT	32462	5905339324627
LL 33W-840-MPR-W-PT	32463	5905339324634

DALI

LFD 23W-830-MAT-B-PT	32344	5905339323446
LFD 23W-830-MAT-SR-PT	32345	5905339323453
LFD 23W-830-MAT-W-PT	32346	5905339323460
LFD 23W-830-MPR-B-PT	32347	5905339323477
LFD 23W-830-MPR-SR-PT	32348	5905339323484
LFD 23W-830-MPR-W-PT	32349	5905339323491
LFD 23W-840-MAT-B-PT	32350	5905339323507
LFD 23W-840-MAT-SR-PT	32351	5905339323514
LFD 23W-840-MAT-W-PT	32352	5905339323521
LFD 23W-840-MPR-B-PT	32353	5905339323538
LFD 23W-840-MPR-SR-PT	32354	5905339323545
LFD 23W-840-MPR-W-PT	32355	5905339323552
LMD 23W-830-MAT-B-PT	32368	5905339323682
LMD 23W-830-MAT-SR-PT	32369	5905339323699
LMD 23W-830-MAT-W-PT	32370	5905339323705
LMD 23W-830-MPR-B-PT	32371	5905339323712
LMD 23W-830-MPR-SR-PT	32372	5905339323729
LMD 23W-830-MPR-W-PT	32373	5905339323736
LMD 23W-840-MAT-B-PT	32374	5905339323743
LMD 23W-840-MAT-SR-PT	32375	5905339323750
LMD 23W-840-MAT-W-PT	32376	5905339323767
LMD 23W-840-MPR-B-PT	32377	5905339323774
LMD 23W-840-MPR-SR-PT	32378	5905339323781
LMD 23W-840-MPR-W-PT	32379	5905339323798
LLD 23W-830-MAT-B-PT	32392	5905339323927
LLD 23W-830-MAT-SR-PT	32393	5905339323934
LLD 23W-830-MAT-W-PT	32394	5905339323941
LLD 23W-830-MPR-B-PT	32395	5905339323958
LLD 23W-830-MPR-SR-PT	32396	5905339323965
LLD 23W-830-MPR-W-PT	32397	5905339323972

LLD 23W-840-MAT-B-PT	32398	5905339323989
LLD 23W-840-MAT-SR-PT	32399	5905339323996
LLD 23W-840-MAT-W-PT	32400	5905339324009
LLD 23W-840-MPR-B-PT	32401	5905339324016
LLD 23W-840-MPR-SR-PT	32402	5905339324023
LLD 23W-840-MPR-W-PT	32403	5905339324030
LFD 33W-830-MAT-B-PT	32416	5905339324160
LFD 33W-830-MAT-SR-PT	32417	5905339324177
LFD 33W-830-MAT-W-PT	32418	5905339324184
LFD 33W-830-MPR-B-PT	32419	5905339324191
LFD 33W-830-MPR-SR-PT	32420	5905339324207
LFD 33W-830-MPR-W-PT	32421	5905339324214
LFD 33W-840-MAT-B-PT	32422	5905339324221
LFD 33W-840-MAT-SR-PT	32423	5905339324238
LFD 33W-840-MAT-W-PT	32424	5905339324245
LFD 33W-840-MPR-B-PT	32425	5905339324252
LFD 33W-840-MPR-SR-PT	32426	5905339324269
LFD 33W-840-MPR-W-PT	32427	5905339324276
LMD 33W-830-MAT-B-PT	32440	5905339324405
LMD 33W-830-MAT-SR-PT	32441	5905339324412
LMD 33W-830-MAT-W-PT	32442	5905339324429
LMD 33W-830-MPR-B-PT	32443	5905339324436
LMD 33W-830-MPR-SR-PT	32444	5905339324443
LMD 33W-830-MPR-W-PT	32445	5905339324450
LMD 33W-840-MAT-B-PT	32446	5905339324467
LMD 33W-840-MAT-SR-PT	32447	5905339324474
LMD 33W-840-MAT-W-PT	32448	5905339324481
LMD 33W-840-MPR-B-PT	32449	5905339324498
LMD 33W-840-MPR-SR-PT	32450	5905339324504
LMD 33W-840-MPR-W-PT	32451	5905339324511
LLD 33W-830-MAT-B-PT	32464	5905339324641
LLD 33W-830-MAT-SR-PT	32465	5905339324658
LLD 33W-830-MAT-W-PT	32466	5905339324665
LLD 33W-830-MPR-B-PT	32467	5905339324672
LLD 33W-830-MPR-SR-PT	32468	5905339324689
LLD 33W-830-MPR-W-PT	32469	5905339324696
LLD 33W-840-MAT-B-PT	32470	5905339324702
LLD 33W-840-MAT-SR-PT	32471	5905339324719
LLD 33W-840-MAT-W-PT	32472	5905339324726
LLD 33W-840-MPR-B-PT	32473	5905339324733
LLD 33W-840-MPR-SR-PT	32474	5905339324740
LLD 33W-840-MPR-W-PT	32475	5905339324757

Kanlux

ALIN 4LED

OPRAWA LINIOWA POD TUBY T8 LED ▶ T8 LED TUBE LINEAR FITTINGS

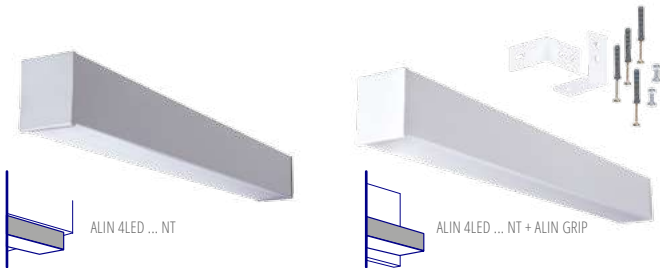

Kanlux FACTORY



Kanlux ALIN 4LED to oprawa dostosowana do tub T8 LED. To rozwiązanie dla tych, którzy cenią sobie wymienne źródło światła. Markowe komponenty i perfekcyjne wykonanie zapewniają estetykę i trwałość działania przez długie lata. Szeroka oferta modeli daje możliwość dopasowania oprawy do potrzeb każdej inwestycji.



5 lat Gwarancji na warunkach oświadczenia gwarancyjnego, dostępnego na stronie internetowej: www.kanlux.com

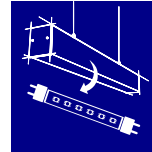

The Kanlux ALIN 4LED is a fixture adapted to T8 LED fluorescent lamps. It is a solution for those who appreciate a replaceable light source. The branded components and perfect workmanship ensure the aesthetics and durability of operation for many years. The wide range of models affords the possibility to adjust the fixture to the needs of each investment.

5 years Warranty under the terms of the warranty statement, available on our website: www.kanlux.com

CONFIGURATOR

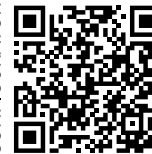

Wyprodukujemy dla Ciebie oprawę idealną. Stwórz ją z pomocą naszego konfiguratora.

We will produce a perfect luminaire for you. Create it with our configurator.



UNIKALNA LINIA ŚWIETLNA
UNIQUE LIGHTING LINE

TRZY DŁUGOŚCI OPRAWY
THREE LENGTHS

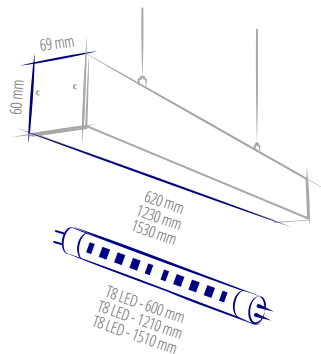

TRZY WERSJE MONTAŻU
THREE VERSIONS OF MOUNTING

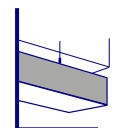

ZWIESZANA
SUSPENDED
MOUNTED

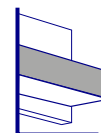

DO NADBUDOWANIA
NA ŚCIANIE
WALL MOUNTED

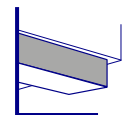

NATYNKOWA
SURFACE
MOUNTED

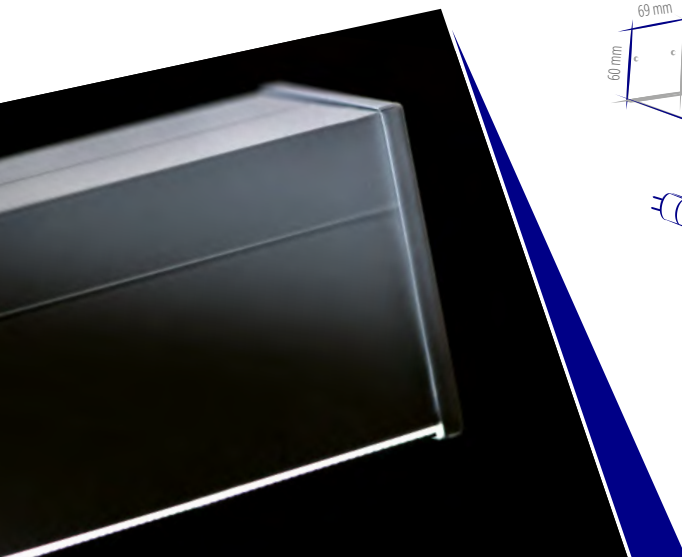

LEGENDA ► KEY

AL 4LED	KANLUXALIN 4LED
MAT	klosz matowy / matt lampshade
MPR	klosz mikropryzmatyczny / microprismatic lampshade
W	kolor obudowy: biały / housing colour: white
B	kolor obudowy: czarny / housing colour: black
SR	kolor obudowy: srebrny / housing colour: silver
NT	wersja natynkowa / surface-mounted
ALIN NT +ALIN NT GRIP	wersja do nadbudowania na ścianie / wall mounted
SE	wersja z czujnikiem ruchu / motion sensor

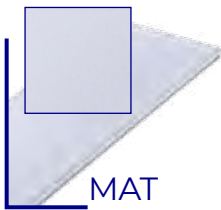

MATOWY
MATT

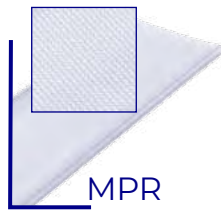

MIKROPRYZMATYCZNY
MICROPRISMATIC

DWA RODZAJE DYFUZORA
TWO TYPES OF DIFFUSER



BIAŁY
WHITE



CZARNY
BLACK



SREBNY
SILVER

TRZY KOLORY OBUDOWY
THREE HOUSING COLORS

WHAT MAKES US DIFFERENT?

AL 4LED 120-MPR-B	28450	5905339284501
AL 4LED 120-MPR-B-NT	28447	5905339284471
AL 4LED 120-MPR-SR	28451	5905339284518
AL 4LED 120-MPR-SR-NT	28448	5905339284488
AL 4LED 120-MPR-W	28449	5905339284495
AL 4LED 120-MPR-W-NT	28446	5905339284464
AL 4LED 150-MPR-B	28456	5905339284563
AL 4LED 150-MPR-B-NT	28453	5905339284532
AL 4LED 150-MPR-SR	28457	5905339284570
AL 4LED 150-MPR-SR-NT	28454	5905339284549
AL 4LED 150-MPR-W	28455	5905339284556
AL 4LED 150-MPR-W-NT	28452	5905339284525

AL 4LED 60-MPR-B	28444	5905339284440
AL 4LED 60-MPR-B-NT	28441	5905339284419
AL 4LED 60-MPR-SR	28445	5905339284457
AL 4LED 60-MPR-SR-NT	28442	5905339284426
AL 4LED 60-MPR-W	28443	5905339284433
AL 4LED 60-MPR-W-NT	28440	5905339284402
ALIN 4LED 1X120-B	27414	5905339274144
ALIN 4LED 1X120-B-NT	27420	5905339274205
ALIN 4LED 1X120-SR	27415	5905339274151
ALIN 4LED 1X120-SR-NT	27421	5905339274212
ALIN 4LED 1X120-W	27413	5905339274137
ALIN 4LED 1X120-W-NT	27419	5905339274199

ALIN 4LED 1X150-B	27423	5905339274236
ALIN 4LED 1X150-B-NT	27426	5905339274267
ALIN 4LED 1X150-SR	27424	5905339274243
ALIN 4LED 1X150-SR-NT	27427	5905339274274
ALIN 4LED 1X150-W	27422	5905339274229
ALIN 4LED 1X150-W-NT	27425	5905339274250
ALIN 4LED 1X60-B	27411	5905339274113
ALIN 4LED 1X60-B-NT	27417	5905339274175
ALIN 4LED 1X60-SR	27412	5905339274120
ALIN 4LED 1X60-SR-NT	27418	5905339274182
ALIN 4LED 1X60-W	27410	5905339274106
ALIN 4LED 1X60-W-NT	27416	5905339274168



ALIN NT GRIP

AKCESORIA ► ACCESSORIES

ALIN NT GRIP	29557	5905339295576
--------------	--------------	---------------

Uchwyt ścienny do oprawy ALIN, 2 szt w komplecie | Wall bracket for the ALIN luminaire, 2 pcs included



OFIS LED

OPRAWA BIUROWA LED ► LED OFFICE FIXTURE



Kanlux OFIS LED to rodzina nowoczesnych opraw biurowych z wieloma udogodnieniami do indywidualnego wyboru. Dzięki zastosowaniu unikatowych modułów LED oprawy gwarantują równomierny rozsył światła, a możliwość wyboru dyfuzora spośród kilku dostępnych modeli pozwala na osiągnięcie ciekawych efektów wizualnych.



5 lat Gwarancji na warunkach oświadczenia gwarancyjnego, dostępnego na stronie internetowej: www.kanlux.com



The Kanlux OFIS LED is a family of modern office fixtures with many options for individual choice. Thanks to the use of unique LED modules, the fixtures guarantee uniform light distribution, and the possibility of choosing a diffuser from among several available models allows you to achieve interesting visual effects.



5 years Warranty under the terms of the warranty statement, available on our website: www.kanlux.com

CONFIGURATOR



Wyprodukujemy dla Ciebie oprawę idealną. Stwórz ją z pomocą naszego konfiguratora.

We will produce a perfect luminaire for you. Create it with our configurator.

DWIE WERSJE TWO VERSIONS

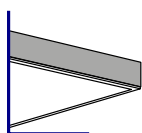

NATYNKOWA
SURFACE MOUNTED

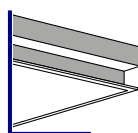

PODTYNKOWA
RECESSED MOUNTED

WYMIARY SIZE

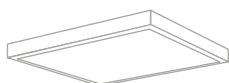

N1 615mm x 615mm



N2 615mm x 295mm



N3 1225mm X 295mm

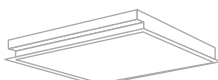

P1 595mm x 595mm



CIEPŁO BIAŁA
WARM WHITE



NEUTRALNA
NEUTRAL

DWIE BARWY ŚWIATŁA TWO COLOR TEMPERATURES

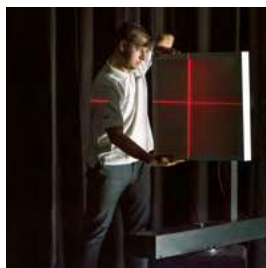

LEGENDA ► KEY

OF	OFIS LED
OFD	OFIS LED DALI
17W - 64W	moc [W] power [W]
830	Ra≥80 3000K
840	Ra≥80 4000K
MAT	mleczny / opalowy dyfuzor milky / opal diffuser
MPRM	mikropryzmatyczny dyfuzor typu M microprismatic diffuser type M
MPRD	mikropryzmatyczny dyfuzor typu D microprismatic diffuser type D
W	kolor obudowy: biały colour of housing: white
N1	wersja natynkowa 615x615 surface mounted 615x615
N2	wersja natynkowa 615x295 surface mounted 615x295
N3	wersja natynkowa 1225x295 surface mounted 1225x295
P1	wersja podtynkowa 595x595 recessed mounted 595x595



MARKOWE SPECJALNIE
WYSELEKCYJONOWANE LED
SPECIALLY SELECTED
LED CHIPS



ZASILACZ
TRIDONIC
TRIDONIC
DRIVER



SZYBKI
MONTAŻ
QUICK
INSTALLATION

OPCJONALNIE
STEROWANIE DALI
DALI LED DRIVER
AVAILABLE
AS AN OPTION

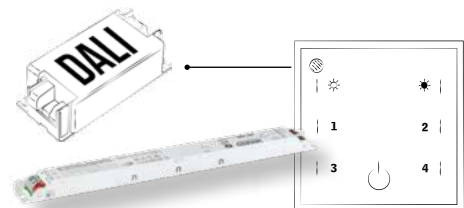

TRZY RODZAJE
DYFUZORA
THREE TYPES
OF DIFFUSER



mleczny / opalowy
milky / opal



mikropryzmatyczny typu M
microprismatic type M

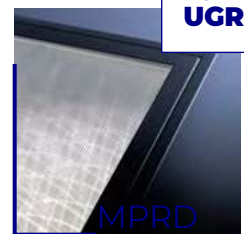

mikropryzmatyczny typu D
microprismatic type D

**LOW
UGR**

OFIS LED...NT

OPRAWA BIUROWA LED WERSJA NATYNKOWA
 ► LED OFFICE FIXTURE SOURCE MOUNTED

N1		
OF 25W-830-MAT-W-N1	28560	5905339285607
OF 25W-830-MPRD-W-N1	28568	5905339285683
OF 25W-830-MPRM-W-N1	28564	5905339285645
OF 25W-840-MAT-W-N1	28561	5905339285614
OF 25W-840-MPRD-W-N1	28571	5905339285713
OF 25W-840-MPRM-W-N1	28565	5905339285652
OF 33W-830-MAT-W-N1	28572	5905339285720
OF 33W-830-MPRD-W-N1	28580	5905339285805
OF 33W-830-MPRM-W-N1	28576	5905339285768
OF 33W-840-MAT-W-N1	28573	5905339285737
OF 33W-840-MPRD-W-N1	28581	5905339285812
OF 33W-840-MPRM-W-N1	28577	5905339285775
OF 37W-830-MAT-W-N1	28624	5905339286246
OF 37W-840-MAT-W-N1	28625	5905339286253
OF 37W-840-MPRD-W-N1	32900	5905339329004
OF 43W-830-MAT-W-N1	28628	5905339286284
OF 43W-840-MAT-W-N1	28629	5905339286291
OF 43W-840-MPRD-W-N1	32901	5905339329011
OF 51W-830-MAT-W-N1	28924	5905339289247
OF 51W-840-MAT-W-N1	28925	5905339289254
OF 51W-840-MPRD-W-N1	32902	5905339329028
OF 64W-830-MAT-W-N1	28620	5905339286208
OF 64W-840-MAT-W-N1	28621	5905339286215
OF 64W-840-MPRD-W-N1	32903	5905339329035

N1 DALI		
OFD 25W-830-MAT-W-N1	28562	5905339285621
OFD 25W-830-MPRD-W-N1	28570	5905339285706
OFD 25W-830-MPRM-W-N1	28566	5905339285669
OFD 25W-840-MAT-W-N1	28563	5905339285638
OFD 25W-840-MPRD-W-N1	28569	5905339285690
OFD 25W-840-MPRM-W-N1	28567	5905339285676
OFD 33W-830-MAT-W-N1	28574	5905339285744
OFD 33W-830-MPRD-W-N1	28582	5905339285829
OFD 33W-830-MPRM-W-N1	28578	5905339285782
OFD 33W-840-MAT-SR-N1	32906	5905339329066
OFD 33W-840-MAT-W-N1	28575	5905339285751
OFD 33W-840-MPRD-W-N1	28583	5905339285836
OFD 33W-840-MPRM-W-N1	28579	5905339285799

N2		
OF 17W-830-MAT-W-N2	28910	5905339289100
OF 17W-830-MPRD-W-N2	28918	5905339289186
OF 17W-830-MPRM-W-N2	28914	5905339289148
OF 17W-840-MAT-W-N2	28911	5905339289117
OF 17W-840-MPRD-W-N2	28919	5905339289193
OF 17W-840-MPRM-W-N2	28915	5905339289155

N2 DALI		
OFD 17W-830-MAT-W-N2	28912	5905339289124
OFD 17W-830-MPRD-W-N2	28920	5905339289209
OFD 17W-830-MPRM-W-N2	28916	5905339289162
OFD 17W-840-MAT-W-N2	28913	5905339289131
OFD 17W-840-MPRD-W-N2	28921	5905339289216
OFD 17W-840-MPRM-W-N2	28917	5905339289179

N3		
OF 33W-830-MAT-W-N3	28584	5905339285843
OF 33W-830-MPRD-W-N3	28592	5905339285928
OF 33W-830-MPRM-W-N3	28588	5905339285881
OF 33W-840-MAT-W-N3	28585	5905339285850
OF 33W-840-MPRD-W-N3	28593	5905339285935
OF 33W-840-MPRM-W-N3	28589	5905339285898
OF 64W-840-MAT-W-N3	32907	5905339329073

N3 DALI		
OFD 33W-830-MAT-W-N3	28586	5905339285867
OFD 33W-830-MPRD-W-N3	28594	5905339285942
OFD 33W-830-MPRM-W-N3	28590	5905339285904
OFD 33W-840-MAT-W-N3	28587	5905339285874
OFD 33W-840-MPRD-W-N3	28595	5905339285959
OFD 33W-840-MPRM-W-N3	28591	5905339285911



N1 615mm x 615mm



N2 615mm x 295mm



N3 1225mm X 295mm

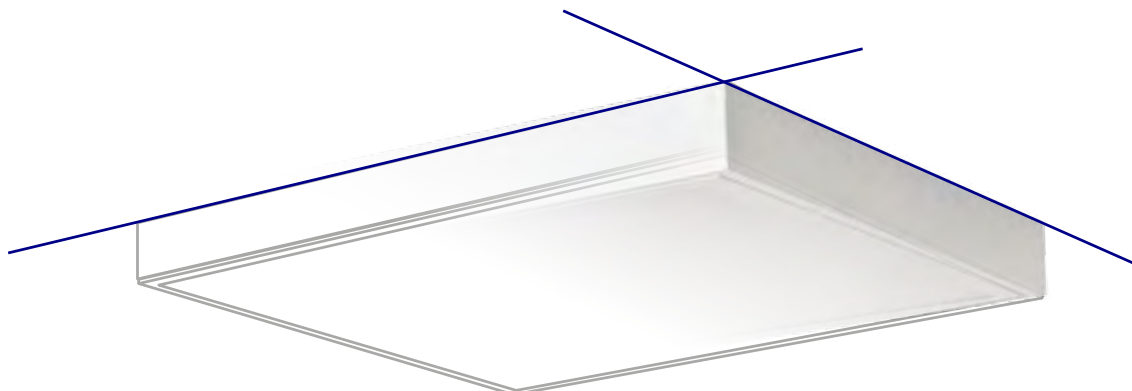

OFIS LED...PT

OPRAWA BIUROWA LED WERSJA PODTYNKOWA

▶ LED OFFICE FIXTURE RECESSED MOUNTED

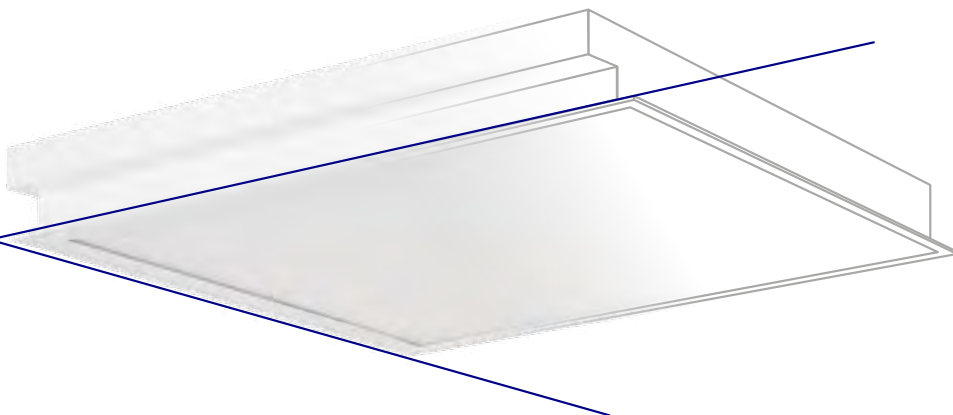

P1		
OF 25W-830-MAT-W-P1	28596	5905339285966
OF 25W-830-MPRD-W-P1	28604	5905339286048
OF 25W-830-MPRM-W-P1	28600	5905339286000
OF 25W-840-MAT-W-P1	28597	5905339285973
OF 25W-840-MPRD-W-P1	28605	5905339286055
OF 25W-840-MPRM-W-P1	28601	5905339286017
OF 33W-830-MAT-W-P1	28608	5905339286086
OF 33W-830-MPRD-W-P1	28616	5905339286161
OF 33W-830-MPRM-W-P1	28612	5905339286123
OF 33W-840-MAT-B-P1	32904	5905339329042
OF 33W-840-MAT-W-P1	28609	5905339286093
OF 33W-840-MPRD-W-P1	28617	5905339286178
OF 33W-840-MPRM-W-P1	28613	5905339286130
OF 37W-830-MAT-W-P1	28627	5905339286277
OF 37W-840-MAT-W-P1	28626	5905339286260
OF 43W-830-MAT-W-P1	28923	5905339289230
OF 43W-840-MAT-W-P1	28922	5905339289223
OF 51W-830-MAT-W-P1	28927	5905339289278
OF 51W-840-MAT-W-P1	28926	5905339289261
OF 64W-830-MAT-W-P1	28622	5905339286222
OF 64W-840-MAT-W-P1	28623	5905339286239

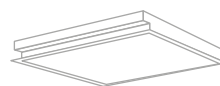

P1 595mm x 595mm

P1 DALI		
OFD 25W-830-MPRD-W-P1	28606	5905339286062
OFD 25W-830-MPRM-W-P1	28602	5905339286024
OFD 25W-840-MAT-W-P1	28599	5905339285997
OFD 25W-840-MPRD-W-P1	28607	5905339286079
OFD 25W-840-MPRM-W-P1	28603	5905339286031
OFD 33W-830-MAT-W-P1	28610	5905339286109
OFD 33W-830-MPRD-W-P1	28618	5905339286185
OFD 33W-830-MPRM-W-P1	28614	5905339286147
OFD 33W-840-MAT-B-P1	32905	5905339329059
OFD 33W-840-MAT-W-P1	28611	5905339286116
OFD 33W-840-MPRD-W-P1	28619	5905339286192
OFD 33W-840-MPRM-W-P1	28615	5905339286154



OFIS S LED

OPRAWA BIUROWA LED ► LED OFFICE FIXTURE



OFIS S LED ... NT...N1



OFIS S LED ... NT...N3



OFIS S LED ... PT...P1



OFIS S LED ... PT...P3

MARKOWE DIODY I ZASILACZE OSRAM/TRIDONIC
BRANDED LEDS AND OSRAM/TRIDONIC DRIVERS



DWIE WERSJE
TWO VERSIONS

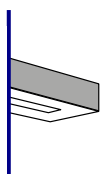

NATYNKOWA
SURFACE
MOUNTED

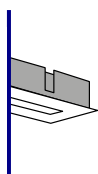

PODTYNKOWA
RECESSED
MOUNTED

DWA KOLORY OBUDOWY
TWO HOUSING
COLORS



BIAŁY
WHITE



CZARNY
BLACK

DWIE BARWY
ŚWIATEŁA
TWO COLOR
TEMPERATURES



CIEPŁO BIAŁA
WARM WHITE



NEUTRALNA
NEUTRAL



Kanlux OFIS S LED to seria nowoczesnych opraw przeznaczonych przede wszystkim do powierzchni biurowych. Prosta, wyjątkowo płaska obudowa czyni oprawę bardzo elegancką dzięki czemu idealnie wpisują się ona w płaszczyznę sufitu. Możliwość wyboru koloru obudowy, dyfuzora oraz temperatury barwowej czyni ją wyjątkowo wszechstronną, a unikatowa konstrukcja maksymalnie przyspiesza montaż.



5 lat Gwarancji na warunkach oświadczenia gwarancyjnego, dostępnego na stronie internetowej: www.kanlux.com



Kanlux OFIS S LED is a series of modern luminaires intended primarily for office spaces. The simple, extremely flat casing makes the luminaire very elegant so it blends perfectly into the ceiling plane. The possibility of selecting the casing colour, the diffuser and the colour temperature makes it eminently versatile, and the unique design accelerates assembly to the maximum.

5 years Warranty under the terms of the warranty statement, available on our website: www.kanlux.com

CONFIGURATOR



Wyprodukujemy dla Ciebie oprawę idealną. Stwórz ją z pomocą naszego konfiguratora.

We will produce a perfect luminaire for you. Create it with our configurator.

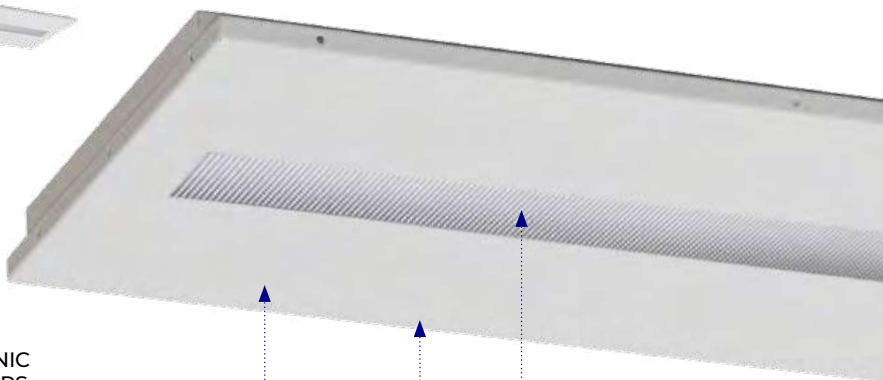

LEGENDA ► KEY

OS	OFIS S LED
OSD	OFIS S LED DALI
40W	moc [W] power [W]
830	Ra≥80 3000K
840	Ra≥80 4000K
MAT	klosz matowy / matt lampshade
MPRM	klosz mikropryzmatyczny / microprismatic lampshade
W	kolor obudowy: biały housing colour: white
B	kolor obudowy: czarny housing colour: black
N1	wersja natynkowa 600x600 surface mounted 600x600
N3	wersja natynkowa 1200x300 surface mounted 1200x300
P1	wersja podtynkowa 595x595 recessed mounted 595x595
P3	wersja podtynkowa 1195x295 recessed mounted 1195x295

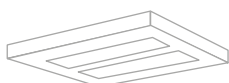

N1 600mm x 600mm

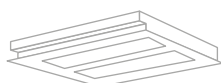

P1 595mm x 595mm

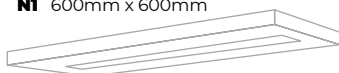

N2 1200mm x 300mm



P2 1195mm x 295mm

WYMIARY
SIZE

OPCJONALNIE
STEROWANIE DALI
DALI LED DRIVER
AVAILABLE
AS AN OPTION

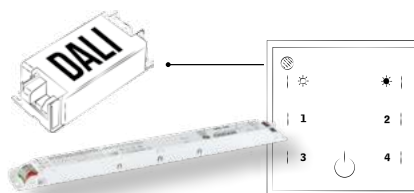

DWA RODZAJE DYFUZORA
TWO TYPES OF DIFFUSER

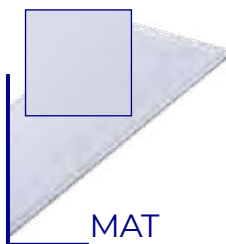

MATOWY
MATT

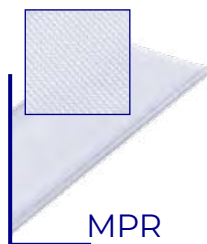

MIKROPRYZMATYCZNY
MICROPRISMATIC

OS 40W-840-MPRM-B-N1	32824	5905339328243
OS 40W-840-MPRM-B-N3	32825	5905339328250
OS 40W-840-MPRM-B-P1	32826	5905339328267
OS 40W-840-MPRM-B-P3	32827	5905339328274
OS 40W-840-MPRM-W-N1	32820	5905339328205
OS 40W-840-MPRM-W-N3	32821	5905339328212
OS 40W-840-MPRM-W-P1	32822	5905339328229
OS 40W-840-MPRM-W-P3	32823	5905339328236

FUTURIO LED

OPRAWA PYŁOSZCZELNA LED ► LED DUSTPROOF LIGHTING FITTING



FACTORY



Kanlux FUTURIO LED to seria opraw hermetycznych, która produkowana jest w fabryce Kanlux. Wyróżnia ją wysoka jakość wykonania oraz imponujące parametry. Kanlux FUTURIO LED to również szybki i łatwy montaż. Szeroka oferta modeli daje możliwość dopasowania oprawy do potrzeb każdej inwestycji. Dostępne są również wersje specjalistyczne: do zastosowania w wysokich temperaturach lub o wysokim strumieniu świetlnym.

5 lat Gwarancji na warunkach oświadczenia gwarancyjnego, dostępnego na stronie internetowej: www.kanlux.com

The Kanlux FUTURIO LED is a series of hermetic fixtures which is produced in the Kanlux factory. They are distinguished by high quality of workmanship and impressive parameters. The Kanlux FUTURIO LED is also quick and easy to install. A wide range of models affords the possibility to adjust the fixture to the needs of each investment. Specialist versions are also available: for high-temperature applications or with high luminous flux.

5 years Warranty under the terms of the warranty statement, available on our website: www.kanlux.com

CONFIGURATOR



Wyprodukujemy dla Ciebie oprawę idealną. Stwórz ją z pomocą naszego konfiguratora.

We will produce a perfect luminaire for you. Create it with our configurator.

MARKOWE DIODY I ZASILACZE OSRAM/TRIDONIC
BRANDED LEDS AND OSRAM/TRIDONIC DRIVERS



DWIE DŁUGOŚCI
TWO LENGTHS

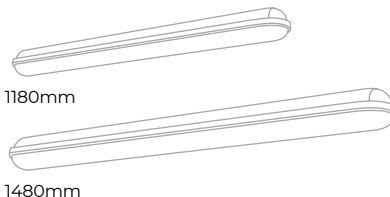

SZYBKA INSTALACJA
BEZ KONIECZNOŚCI
OTWIERANIA OPRAWY
EASY MOUNTING
WITHOUT THE
NECESSITY OF OPENING
THE FIXTURE

MOŻLIWOŚĆ REGULACJI
ZA POMOCĄ UCHWYTÓW
MONTAŻOWYCH
ADJUSTABLE MOUNTING
BRACKET



MOŻLIWOŚĆ
ŁĄCZENIA W LINIE
POSSIBILITY OF
LINEAR CONNECTION



LEGENDA ► KEY

FT	FUTURIO LED
FTD	FUTURIO LED DALI
26W - 73W	moc [W] power [W]
840	Ra≥80 4000K
OPL	klosz opalowy opal lamshade
RYF	klosz ze strukturą pryzmatyczną prismatic structure lamshade
INT	soczewka wąskostrumieniowa narrow beam angle lens
ASY	soczewka asymetryczna asymmetrical beam angle lens
FTHL	wersja specjalna o wysokim strumieniu świetlnym special version with high lumen
FTHT	wersja specjalna do pracy w wyższych temperaturach special version to work with high temperature



OPCJONALNIE STEROWANIE DALI
DALI LED DRIVER AVAILABLE AS AN OPTION

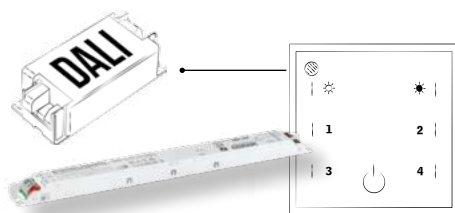

IP 65
IK 08



DWIE WERSJE Z SOCZEWKAMI
TWO MODELS WITH LENSES



INTENSE
wąskostrumieniowy
narrow beam angle



ASY
asymetryczny
asymmetric beam angle

DWA RODZAJE KLOSZY
TWO TYPES OF LAMP SHADES



RYF
ze strukturą pryzmatyczną
prismatic structure



OPL
opalowy
opal

FUTURIO LED

OPRAWA PYŁOSZCZELNA LED ► LED DUSTPROOF LIGHTING FITTING



FT1200 26W-840-RYF	28687	5905339286871
FT1200 28W-840-ASY	28853	5905339288530
FT1200 28W-840-INT	28852	5905339288523
FT1200 28W-840-OPL	28850	5905339288509
FT1200 28W-840-RYF	28851	5905339288516
FT1200 37W-840-ASY	28634	5905339286345
FT1200 37W-840-INT	28633	5905339286338
FT1200 37W-840-OPL	28630	5905339286307
FT1200 37W-840-RYF	28631	5905339286314
FT1200 49W-840-ASY	28648	5905339286482
FT1200 49W-840-INT	28647	5905339286475
FT1200 49W-840-OPL	28644	5905339286444
FT1200 49W-840-RYF	28645	5905339286451
FT1500 43W-840-ASY	28861	5905339288615
FT1500 43W-840-INT	28860	5905339288608
FT1500 43W-840-OPL	28858	5905339288585
FT1500 43W-840-RYF	28859	5905339288592
FT1500 55W-840-ASY	28662	5905339286628
FT1500 55W-840-INT	28661	5905339286611
FT1500 55W-840-OPL	28665	5905339286659
FT1500 55W-840-RYF	28659	5905339286598
FT1500 66W-840-RYF	28686	5905339286864
FTD1200 28W-840-ASY	28857	5905339288578
FTD1200 28W-840-INT	28856	5905339288561
FTD1200 28W-840-OPL	28854	5905339288547



FTD1200 28W-840-RYF	28855	5905339288554
FTD1200 37W-840-ASY	28641	5905339286413
FTD1200 37W-840-INT	28640	5905339286406
FTD1200 37W-840-OPL	28637	5905339286376
FTD1200 37W-840-RYF	28638	5905339286383
FTD1200 49W-840-ASY	28655	5905339286550
FTD1200 49W-840-INT	28654	5905339286543
FTD1200 49W-840-OPL	28651	5905339286512
FTD1200 49W-840-RYF	28652	5905339286529
FTD1500 43W-840-ASY	28865	5905339288653
FTD1500 43W-840-INT	28864	5905339288646
FTD1500 43W-840-OPL	28862	5905339288622
FTD1500 43W-840-RYF	28863	5905339288639
FTD1500 55W-840-ASY	28669	5905339286697
FTD1500 55W-840-INT	28668	5905339286680
FTD1500 55W-840-OPL	28658	5905339286581
FTD1500 55W-840-RYF	28666	5905339286666
FTHL1500 73W-840-ASY	28869	5905339288691
FTHL1500 73W-840-INT	28868	5905339288684
FTHL1500 73W-840-OPL	28866	5905339288660
FTHL1500 73W-840-RYF	28867	5905339288677
FIHT1500 43W-840-ASY	28873	5905339288738
FIHT1500 43W-840-INT	28872	5905339288721
FIHT1500 43W-840-OPL	28870	5905339288707
FIHT1500 43W-840-RYF	28871	5905339288714



Kanlux FACTORY

Przemysłane projekty
Intelligent design

Kanlux FACTORY

Nowoczesny park maszynowy
Modern machine park

Kanlux FACTORY

Jakość, której możesz zaufać
Quality, you can trust

Kanlux FACTORY

Perfekcyjne wykończenie
Perfect finish

Kanlux

FACTORY

Kanlux FACTORY

Pozwól, że rozświetlimy
Twoją firmę

Kanlux FACTORY

Let us light up your
company



Kanlux
FACTORY
CONFIGURATOR

**Dopasujemy światło
do Twoich potrzeb
We will match the light
with your needs**



**SAM KONFIGURUJ IDEALNĄ OPRAWĘ
CONFIGURE THE PERFECT LUMINAIRE ON YOUR OWN**

DŁUGOŚĆ
LENGTH

KLOSZ
LAMPSHADE

TEMPERATURA BARWOWA
COLOR TEMPERATURE

MOC
POWER

KOLOR
COLOUR

SPOSÓB MONTAŻU
ASSEMBLY



Kanlux **ALIN**



Kanlux **FUTURIO**



Kanlux **OFIS**



Kanlux **OFIS S**



Wyprodukujemy dla Ciebie
oprawę idealną. Stwórz ją
z pomocą naszego konfiguratora.

We will produce a perfect
luminaire for you. Create it
with our configurator.



kanlux.com ▶

Kanlux



ŹRÓDŁA ŚWIATŁA

LIGHT SOURCES

Zależy Ci na tym aby produkty, którymi się otaczasz były bezpieczne i trwałe. Dbamy o to podczas produkcji i w naszym laboratorium Kanlux. Mamy pewność, że oddajemy w Twoje ręce produkt całkowicie bezpieczny i spełniający Twoje wymagania.

You want the products around you to be safe and durable. We take care of all of this it during the production and in our Kanlux laboratory. We are sure that we give you a product that is completely safe and meets your requirements.



*dane fotometryczne znajdziesz na:
photometric data you can find on:*

► [kanlux.com](https://www.kanlux.com)

IQ-LED A60

ŹRÓDŁO ŚWIATŁA LED ▶ LED LIGHT SOURCE



IQ-LED A60 5,5W, IQ-LED A60 9W, IQ-LED A60 10,5W



IQ-LED A60 5,5W, IQ-LED A60 9W,
IQ-LED A60 10,5W



IQ-LED A60 14W



Safety
Regular
Production
Surveillance

www.kanlux.com
ID 0000055711



Kanlux IQ-LED to bezpieczeństwo fotobiologiczne, przyjazna oczom temperatura barwowa i niezawodność, a to wszystko zachowane w klasycznym designie A60. Żarówki Kanlux IQ-LED zapewniają pełen komfort użytkowania oraz bezpieczeństwo, które potwierdza certyfikat TÜV Rheinland.

Materiał: tworzywo sztuczne

Materiał klosza: tworzywo sztuczne

The Kanlux IQ-LED means photobiological safety and eye-friendly colour temperature and reliability, all in the classic A60 design. IQ-LED bulbs provide full comfort of use and safety, which is confirmed by the TÜV Rheinland certificate.

Materiał: plastic

Lampshade material: plastic



Model	Code	Power [W]	Frequency [Hz]	Beam angle [°]	Color Rendering Index [Ra]	Life span [h]	Mercury-free	RoHS	CE	EAC
IQ-LED A60 5,5W-WW	27270	5,5	40	470	2700	240	E27			
IQ-LED A60 5,5W-NW	27271	5,5	41	480	4000	240	E27			
IQ-LED A60 5,5W-CW	27272	5,5	41	480	6500	240	E27			
IQ-LED A60 9W-WW	27273	9	60	810	2700	220	E27			
IQ-LED A60 9W-NW	27274	9	60	810	4000	220	E27			
IQ-LED A60 9W-CW	27275	9	60	810	6500	220	E27			
IQ-LED A60 10,5W-WW	27276	10,5	75	1060	2700	220	E27			
IQ-LED A60 10,5W-NW	27277	10,5	76	1080	4000	220	E27			
IQ-LED A60 10,5W-CW	27278	10,5	76	1080	6500	220	E27			
IQ-LED A60 14W-WW	27279	14	100	1520	2700	200	E27			
IQ-LED A60 14W-NW	27280	14	103	1580	4000	200	E27			
IQ-LED A60 14W-CW	27281	14	103	1580	6500	200	E27			

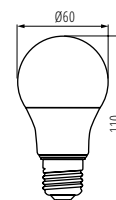

IQ-LED A60 5,5W, IQ-LED A60 9W,
IQ-LED A60 10,5W

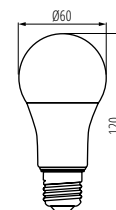

IQ-LED A60 14W



Kanlux

IQ-LED A67

ŹRÓDŁO ŚWIATEŁA LED ► LED LIGHT SOURCE



IQ-LED A67 17,5W, IQ-LED A67 19W



IQ-LED A67 17,5W



IQ-LED A67 19W



Safety
Regular
Production
Surveillance

www.tuv.com
ID 0000055711



Kanlux IQ-LED to bezpieczeństwo fotobiologiczne, przyjazna oczom temperatura barwowa i niezawodność, a to wszystko w nowej, dużej bańce A67. Żarówki Kanlux IQ-LED zapewniają pełen komfort użytkowania oraz bezpieczeństwo, które potwierdza certyfikat TÜV Rheinland.

Materiał klosza: tworzywo sztuczne

Kanlux IQ-LED means photo-biological safety, colour temperature friendly to eyes and reliability and all this in a new, large bulb A67. IQ-LED bulbs ensure full comfort of use and safety, which is confirmed by TÜV Rheinland certificate.

Lampshade material: plastic

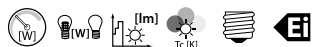

IQ-LED A67 17,5W-WW	27312	5905339273123	17,5	121	1920	2700	E27	A+
IQ-LED A67 17,5W-NW	27313	5905339273130	17,5	126	2000	4000	E27	A+
IQ-LED A67 17,5W-CW	27314	5905339273147	17,5	126	2000	6500	E27	A+
IQ-LED A67 19W-WW	27315	5905339273154	19	150	2450	2700	E27	A++
IQ-LED A67 19W-NW	27316	5905339273161	19	157	2600	4000	E27	A++
IQ-LED A67 19W-CW	27317	5905339273178	19	157	2600	6500	E27	A++

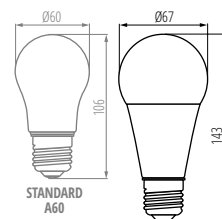

IQ-LED A67 17,5W; 19W

[V]	[Hz]	SMD	dimmable ≤ 600 Nachleuchten	Ra	≥80	≥40000	15000	Hg	RoHS	CE	ENEC
-----	------	-----	--------------------------------	----	-----	--------	-------	----	------	----	------

IQ-LEDDIM A60

ŹRÓDŁO ŚWIATŁA LED ► LED LIGHT SOURCE



IQ-LEDDIM A60 5,5W, IQ-LEDDIM A60 8,5W



IQ-LEDDIM A60 5,5W, IQ-LEDDIM A60 8,5W



IQ-LEDDIM A60 12,5W, IQ-LEDDIM A60 15W



Safety
Regular
Production
Surveillance

www.tuv.com
ID 000005711



Kanlux IQ-LED to bezpieczeństwo fotobiologiczne, przyjazna oczom temperatura barwowa i niezawodność. Teraz to wszystko w nowej wersji z trzonkiem E27 - dodatkowo wersja Kanlux IQ-LEDDIM współpracuje ze ściemniaczami. Żarówki Kanlux IQ-LED zapewniają pełen komfort użytkowania oraz bezpieczeństwo, które potwierdza certyfikat TÜV Rheinland.

Material: tworzywo sztuczne

Kanlux IQ-LED means photo-biological safety, colour temperature friendly to eyes and reliability. Now, all this in a new version with E27 light bulb base - additionally, the IQ-LEDDIM version cooperates with dimmers. IQ-LED bulbs ensure full comfort of use and safety, which is confirmed by TÜV Rheinland certificate.

Material: plastic



Model	Code	Power [W]	Beam Angle [°]	Height [mm]	Width [mm]	Temp [K]	Base	Lifetime [h]
IQ-LEDDIM A60 5,5W-WW	27282	5,5	40	470	2700	240	E27	25000
IQ-LEDDIM A60 5,5W-NW	27283	5,5	42	500	4000	240	E27	25000
IQ-LEDDIM A60 5,5W-CW	27284	5,5	42	510	6500	240	E27	25000
IQ-LEDDIM A60 8,5W-WW	27285	8,5	60	810	2700	240	E27	25000
IQ-LEDDIM A60 8,5W-NW	27286	8,5	63	850	4000	240	E27	25000
IQ-LEDDIM A60 8,5W-CW	27287	8,5	64	880	6500	240	E27	25000
IQ-LEDDIM A60 12,5W-WW	27288	12,5	75	1060	2700	240	E27	25000
IQ-LEDDIM A60 12,5W-NW	27289	12,5	77	1100	4000	240	E27	25000
IQ-LEDDIM A60 12,5W-CW	27290	12,5	77	1100	6500	240	E27	25000
IQ-LEDDIM A60 15W-WW	27291	15	100	1520	2700	240	E27	15000
IQ-LEDDIM A60 15W-NW	27292	15	103	1580	4000	240	E27	15000
IQ-LEDDIM A60 15W-CW	27293	15	103	1580	6500	240	E27	15000

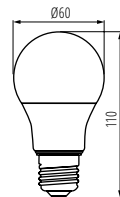

IQ-LEDDIM A60 5,5W, IQ-LEDDIM A60 8,5W

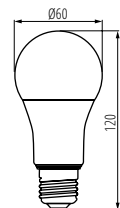

IQ-LEDDIM A60 12,5W, IQ-LEDDIM A60 15W

[V]	[Hz]	SMD	Ra	≥80	≥40000	Hg	EI	CE	EAC
220-240 AC	50		≤ 6x MacAdam				A+		

XLED A60

ŹRÓDŁO ŚWIATŁA LED ► LED LIGHT SOURCE



XLED A60 4,5W



XLED A60 4,5W



XLED A60 7W



XLED A60 8W; 10W



Kanlux XLED łączy w sobie najlepsze cechy tradycyjnych żarówek i nowoczesnych źródeł światła LED. Dlatego mówimy o nim, że to pierwsza prawdziwa „żarówka LED”. Szklana bańka w kształcie tradycyjnej żarówki i diody LED rozmieszczone w taki sposób, że światło rozchodzi się we wszystkich kierunkach, a kąt świecenia wynosi nawet 320 stopni!

Materiał klosza: szkło

Kanlux XLED combines the best features of traditional bulbs and modern LED light sources. Therefore, we talk about it as the first real LED bulb. A glass bulb in the shape of a traditional bulb and LED diodes placed in such a way so that light can part in all directions, and the angle of light comes to even 320 degrees!

Lampshade material: glass

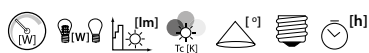

	[W]	[Hz]	FILAMENT	ellipso s 60° Maxidiam	Ra ≥80	≥15000	Hg		CE	ERC
XLED A60 4,5W-WW	29600	5905339296009	4,5	40	470	2700	320	E27	15000	
XLED A60 7W-WW	29601	5905339296016	7	60	810	2700	320	E27	15000	
XLED A60 7W-NW	29602	5905339296023	7	60	810	4000	320	E27	15000	
XLED A60 7W-CW	29603	5905339296030	7	60	810	6500	320	E27	15000	
XLED A60 8W-WW	29604	5905339296047	8	75	1055	2700	320	E27	15000	
XLED A60 10W-WW	29605	5905339296054	10	100	1520	2700	320	E27	10000	
XLED A60 10W-NW	29606	5905339296061	10	100	1520	4000	320	E27	10000	

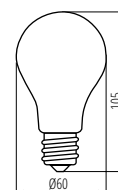

XLED A60 4,5W; 7W; 8W; 10W

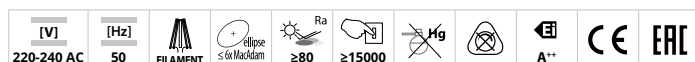

Kanlux

XLED A70

ŹRÓDŁO ŚWIATŁA LED ► LED LIGHT SOURCE

NEW



XLED A70 15W



SUPER HIGH
lumen

320°

NEW GENERATION
bulb

Kanlux XLED łączy w sobie najlepsze cechy tradycyjnych żarówek i nowoczesnych źródeł światła LED. Dlatego mówimy o serii XLED, że to pierwsza prawdziwa „żarówka LED”. Szklana bańka A70 to ponadprzeciętny rozmiar w kształcie tradycyjnej żarówki, a diody LED rozmieszczone są wewnątrz w taki sposób, że światło rozchodzi się we wszystkich kierunkach.

Materiał klosza: szkło

Kanlux XLED combines the best features of traditional bulbs and modern LED light sources. Therefore, we talk about it as the first real "LED bulb". A70 glass bulb has extraordinary size in the shape of a traditional bulb and LED diodes are arranged inside in such a way so that light can part in all directions.

Lampshade material: glass

XLED A70 15W-WW	29639	5905339296399	15	150	2450	2700	320 E27
XLED A70 15W-NW	29640	5905339296405	15	150	2450	4000	320 E27

[V]
220-240 AC

[Hz]
50

FILAMENT

Ra
≥80

≥15000

10000

Hg

A**

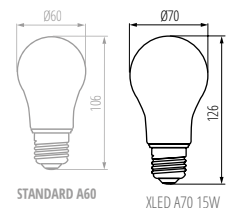

Kanlux

XLED A60M

ŹRÓDŁO ŚWIATEŁA LED ► LED LIGHT SOURCE



XLED A60M 4,5W, XLED A60M 7W,
XLED A60M 8W, XLED A60M 10W

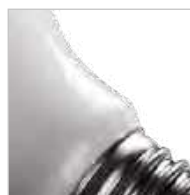

Kanlux XLED łączy w sobie najlepsze cechy tradycyjnych żarówek i nowoczesnych źródeł światła LED. Matowa bańka w kształcie tradycyjnej żarówki i diody LED rozmieszczone w taki sposób, że światło rozchodzi się we wszystkich kierunkach, a kąt świecenia wynosi nawet 320 stopni!

Materiał klosza: szkło

Kanlux XLED combines the best features of traditional bulbs and modern LED light sources. A matt bulb in the shape of a traditional bulb and LED diodes placed in such a way so that light can part in all directions, and the angle of light comes to even 320 degrees!

Lampshade material: glass



XLED A60 4,5W-WW-M	29607	5905339296078	4,5	40	470	2700	320	E27	15000
XLED A60 4,5W-NW-M	29608	5905339296085	4,5	40	470	4000	320	E27	15000
XLED A60 7W-WW-M	29609	5905339296092	7	60	810	2700	320	E27	15000
XLED A60 7W-NW-M	29610	5905339296108	7	60	810	4000	320	E27	15000
XLED A60 7W-CW-M	29611	5905339296115	7	60	810	6500	320	E27	15000
XLED A60 8W-WW-M	29612	5905339296122	8	75	1055	2700	320	E27	15000
XLED A60 8W-NW-M	29613	5905339296139	8	75	1055	4000	320	E27	15000
XLED A60 8W-CW-M	29614	5905339296146	8	75	1055	6500	320	E27	15000
XLED A60 10W-WW-M	29615	5905339296153	10	100	1520	2700	320	E27	10000
XLED A60 10W-NW-M	29616	5905339296160	10	100	1520	4000	320	E27	10000

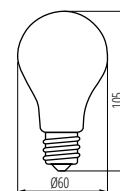

XLED A60 4,5W, XLED A60 7W, XLED A60 8W,
XLED A60 10W

[W]	[Hz]	FILAMENT	elliptical ≤ 6x11x45mm	Ra ≥80	≥15000	Mg		CE	ERC
220-240 AC	50							A**	

XLED A60 B22

ŹRÓDŁO ŚWIATŁA LED ► LED LIGHT SOURCE



XLED A60 B22 7W



XLED A60 B22 7W



XLED A60 B22 7W, 8W, 10W



XLED A60M B22 7W, 8W, 10W



Kanlux XLED łączy w sobie najlepsze cechy tradycyjnych żarówek i nowoczesnych źródeł światła LED. Dlatego mówimy o nim, że to pierwsza prawdziwa „żarówka LED”. Szklana bańka w kształcie tradycyjnej żarówki i diody LED rozmieszczone w taki sposób, że światło rozchodzi się we wszystkich kierunkach, a kąt świecenia wynosi nawet 320 stopni! Kanlux XLED A60 B22 posiada gwint B22.

Materiał klosza: szkło

Kanlux XLED combines the best features of traditional light bulbs and modern LED light sources. That is why we call it the first real “LED bulb”. A glass bulb in the shape of a traditional light bulb and LED diodes arranged in such a way that the light spreads in all directions, and the beam angle is up to 320 degrees! Kanlux XLED A60 B22 has a B22 cap.

Lampshade material: glass

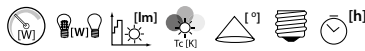

	[W]	[Hz]	FILAMENT	ellipse s/GorMackdam	Ra ≥80	≥15000	Hg	RoHS	A++	CE	EAC
XLED A60 B22 7W-WW	33100	5905339331007	7	60	810	2700	320	B22	15000		
XLED A60 B22 7W-CW	33101	5905339331014	7	60	810	6500	320	B22	15000		
XLED A60 B22 7W-WW-M	33102	5905339331021	7	60	810	2700	320	B22	15000		
XLED A60 B22 7W-CW-M	33103	5905339331038	7	60	810	6500	320	B22	15000		
XLED A60 B22 8W-WW	33104	5905339331045	8	75	1055	2700	320	B22	15000		
XLED A60 B22 8W-WW-M	33105	5905339331052	8	75	1055	2700	320	B22	15000		
XLED A60 B22 8W-CW-M	33106	5905339331069	8	75	1055	2700	320	B22	15000		
XLED A60 B22 10W-CW	33107	5905339331076	10	100	1520	6500	320	B22	10000		
XLED A60 B22 10W-WW-M	33108	5905339331083	10	100	1520	6500	320	B22	10000		
XLED A60 B22 10W-CW-M	33109	5905339331090	10	100	1520	6500	320	B22	10000		

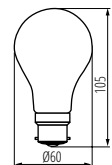

XLED A60 B22

Kanlux

XLED STEPDIM

ŹRÓDŁO ŚWIATŁA LED ► LED LIGHT SOURCE



STEP DIMMING function

- 1x CLICK 100% power
- 2x CLICK 50% power
- 3x CLICK 7% power
- 2x CLICK + RESET 100% power
- <0,5s



XLED A60 7W-STEPPDIM

Kanlux XLED łączy w sobie najlepsze cechy tradycyjnych żarówek i nowoczesnych źródeł światła LED. Dlatego mówimy o nim, że to pierwsza prawdziwa „żarówka LED”. Szklana bańka w kształcie tradycyjnej żarówki i diody LED rozmieszczone w taki sposób, że światło rozchodzi się we wszystkich kierunkach. Dodatkowo w wersji STEPDIM możemy zmniejszać stopniowo strumień świetlny bez dodatkowego ściemniacza.

Materiał klosza: szkło

Kanlux XLED combines the best features of traditional bulbs and modern LED light sources. Therefore, we talk about it as the first real LED bulb. A glass bulb in the shape of a traditional bulb and LED diodes placed in such a way so that light can part in all directions. Additionally, in the STEPDIM version you can gradually reduce the light stream without an additional dimmer.

Lampshade material: glass

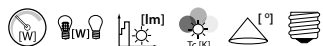

XLEDA60 7W-WW-STEPPDIM	29634	5905339296344	max 7	60	max 810	2700	320	E27
XLEDA60 7W-NW-STEPPDIM	29635	5905339296351	max 7	60	max 810	4000	320	E27

[V]	[Hz]	FILAMENT	ellipse ≤ 6x Max diam	Ra	≥ 15000	[h]	Hg		A++	CE	EAC
220-240 AC	50			≥ 80	≥ 15000	15000					

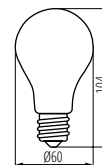

XLED A60 7W-STEPPDIM

Kanlux

XLED CCT

ŹRÓDŁO ŚWIATŁA LED ► LED LIGHT SOURCE



STEP CCT & DIMMING function

- 1x CLICK 6500K 100% power
- 2x CLICK 4000K 100% power
- 3x CLICK 2700K 100% power
- 4x CLICK 6500K 50% power
- 5x CLICK 4000K 50% power
- 6x CLICK 2700K 50% power
- 2x CLICK + RESET 100% power
- <0,5s



XLED A60 7W-STEP CCT

Kanlux XLED łączy w sobie najlepsze cechy tradycyjnych żarówek i nowoczesnych źródeł światła LED. Dlatego mówimy o nim, że to pierwsza prawdziwa „żarówka LED”. Szklana bańka w kształcie tradycyjnej żarówki i diody LED rozmieszczone w taki sposób, że światło rozchodzi się we wszystkich kierunkach. Dodatkowo w wersji CCT możemy zmieniać barwę światła.

Materiał klosza: szkło

Kanlux XLED combines the best features of traditional bulbs and modern LED light sources. Therefore, we talk about it as the first real LED bulb. A glass bulb in the shape of a traditional bulb and LED diodes placed in such a way so that light can part in all directions. Additionally, in the CCT version you can change the colour of light.

Lampshade material: glass



XLED A60 7W-STEP CCT	29636	5905339296368	max 7	60	max 810	2700/4000/6500	320	E27
----------------------	--------------	---------------	-------	----	---------	----------------	-----	-----

[V]	[Hz]	FILAMENT	ellipse ≤ 6x Max diam	Ra	≥ 15000	[h]	Hg		A++	CE	EAC
220-240 AC	50			≥ 80	≥ 15000	15000					

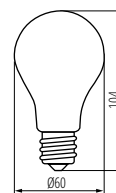

XLED A60 7W-STEP CCT

RAPID E27

ŹRÓDŁO ŚWIATŁA LED ▶ LED LIGHT SOURCE



RAPID E27, RAPID PRO



RAPID E27, RAPID PRO



RAPID MAXX



RAPID HI

	[W]	[W]	[lm]	Tc [K]	[°]			
RAPID E27-NW	32920	5905339329202	5,5	42	500	4000	180	E27
RAPID E27-WW	32921	5905339329219	5,5	42	500	3000	180	E27
RAPID PRO E27-NW	32922	5905339329226	8,5	60	810	4000	180	E27
RAPID PRO E27-WW	32923	5905339329233	8,5	60	810	3000	180	E27
RAPID MAXX E27-NW	32924	5905339329240	10	75	1050	4000	200	E27
RAPID MAXX E27-WW	32925	5905339329257	10	75	1050	3000	200	E27
RAPID HI E27-NW	32926	5905339329264	14	100	1520	4000	200	E27
RAPID HI E27-WW	32927	5905339329271	14	100	1520	3000	200	E27

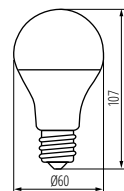
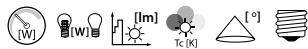

RAPID E27; RAPID PRO E27

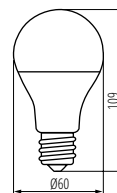

RAPID MAXX E27

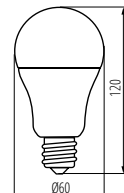

RAPID HI E27



Źródła Kanlux RAPID E27 są LEDowym odpowiednikami tradycyjnych żarówek. Ich wersje Kanlux RAPID HI sięgają najwyższych mocy (nawet 1520 lumenów!). Wyróżniają się przede wszystkim: wysokim strumieniem świetlnym i szerokim kątem świecenia. Dodatkowym atutem tych źródeł jest hybrydowa konstrukcja obudowy.

Materiał klosza: tworzywo sztuczne

Kanlux RAPID E27 sources are LED equivalents of traditional light bulbs. Their Kanlux RAPID HI versions reach the highest power (even 1520 lumens!). They are distinguished primarily by: high luminous flux and wide beam angle. An additional advantage of these sources is the hybrid housing design.

Lampshade material: plastic

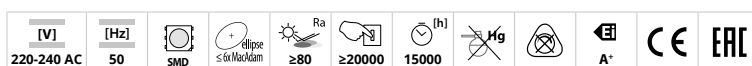

Kanlux LUNI LED

ŹRÓDŁO ŚWIATŁA LED ► LED LIGHT SOURCE



LUNI PRO E27



Kanlux LUNI LED to duże źródła o dekoracyjnym charakterze. Świetnie prezentują się w dużych, otwartych oprawach lub w zwisach przy których nie stosujemy klosza. Źródła Kanlux LUNI LED mają bardzo wysokie strumienie świetlne, dlatego też mogą pojedynczo oświetlać pomieszczenia.

Materiał: tworzywo sztuczne

Kanlux LUNI LED are large, decorative sources of light. They look great in large, open luminaires or in hanging lamps in which shade is not used. Kanlux LUNI LED sources have very high light beams, which is why they can illuminate rooms individually.

Materiał: plastic

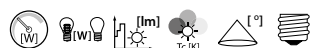

LUNI PRO E27 LED-WW | 22571 | 5905339225719 | 16 | 100 | 1520 | 3000 | 220 | E27

[V]	[Hz]	SMD	Classe ≤ 6 Max⋅sdam	Ra	>=80	>=10000	15000	[h]	Hg	RoHS	CE	EAC
220-240 AC	50											

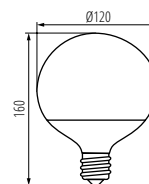

LUNI PRO E27



Kanlux XLED ST64

ŹRÓDŁO ŚWIATŁA LED ► LED LIGHT SOURCE



XLED ST64 7W

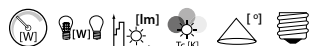

XLED ST64 7W-WW | **29637** | 5905339296375 | 7 | 55 | 725 | 2500 | 320 | E27

[V] 220-240 AC	[Hz] 50	FILAMENT	ellipse ≤ 6x MacAdam	Ra ≥80	≥15000	15000	Hg	RoHS	A+	CE	EAC
-------------------	------------	----------	-------------------------	-----------	--------	-------	----	------	----	----	-----



Kanlux XLED łączy w sobie najlepsze cechy tradycyjnych żarówek i nowoczesnych źródeł światła LED. Dlatego mówimy o nim, że to pierwsza prawdziwa „żarówka LED”. Szklana bańka i diody LED rozmieszczone w taki sposób, że światło rozchodzi się we wszystkich kierunkach. Dodatkowo wersja ST64 wykonana jest ze szkła o złotym zabarwieniu co podkreśla ciepłą barwę światła tego źródła i nadaje mu dodatkowej, szlachetnej elegancji.

Materiał klosza: szkło

Kanlux XLED combines the best features of traditional bulbs and modern LED light sources. Therefore, we talk about it as the first real LED bulb. A glass bulb and LED diodes placed in such a way so that light can part in all directions. Additionally, the ST64 version is made of glass in gold colour, which emphasizes the warm colour of light of this source and gives additional, noble elegance to it.

Lampshade material: glass



XLED ST64-7W

Kanlux XLED G125

ŹRÓDŁO ŚWIATŁA LED ► LED LIGHT SOURCE



XLED G125 7W

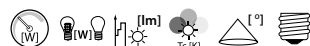

XLED G125 7W-WW | **29638** | 5905339296382 | 7 | 55 | 725 | 2500 | 320 | E27

[V] 220-240 AC	[Hz] 50	FILAMENT	ellipse ≤ 6x MacAdam	Ra ≥80	≥15000	15000	Hg	RoHS	A+	CE	EAC
-------------------	------------	----------	-------------------------	-----------	--------	-------	----	------	----	----	-----



Kanlux XLED to nie tylko najlepsze parametry świetlne, ale również dodatkową dekoracyjność. Żarówki Kanlux XLED G125 to duża okrągła szklana bańka i szeroki kąt świecenia. Kanlux XLED G125 bardzo przyjemnie prezentują się w otwartych lampach i kinkietach, a także w zwisach bez klosza.

Materiał klosza: szkło

Kanlux XLED does not only mean the best lighting parameters, but also additional decorativeness. Kanlux XLED G125 bulbs are a large round glass bulb and a wide angle of light. Kanlux XLED G125 look very pleasant in open lamps and wall lamps as well as in sags without a shade.

Lampshade material: glass

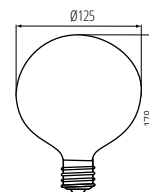

XLED G125 7W

Kanlux XLED SW

ŹRÓDŁO ŚWIATŁA LED ► LED LIGHT SOURCE

NEW



XLED A60 5W



XLED C35T 2,5W



XLED ST64 5W



XLED G95 5W



XLED G125 5W



1800K
SUPER
WARM



DE
CO
RI
function

Dekoracyjna wersja „prawdziwej żarówki LED”. Kanlux XLED w tej wyjątkowej wersji pomoże Ci wykreować bardzo przytulną atmosferę. Wszystko dzięki wyjątkowo ciepłej barwie światła i bursztynowemu szkle, w którym zamknięty jest spiralny filament LED. Ta żarówka stanie się ozdobą twojego domu, kawiarni, restauracji czy każdego innego miejsca, w którym ją zastosujesz. To wyjątkowe połączenie dekoracyjności, stylu vintage i nowoczesnej, energooszczędnej technologii LED.

Materiał klosza: szkło

A decorative version of a “true LED bulb”. Kanlux XLED in this exceptional version will help you create a very cosy atmosphere. All thanks to a very warm colour of the light and an amber glass in which a spiral LED filament is enclosed. This bulb will become a decoration of your house, café, restaurant and any other place in which you will install it. It is an exceptional combination of a decorative nature, vintage style and modern energy-efficient LED technology.

Lampshade material: glass

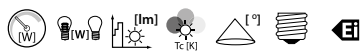

Model	Code	Part No.	Power [W]	Voltage [V]	Height [mm]	Width [mm]	Beam Angle [°]	Base	Energy Class
XLED C35T 2,5W-SW	29641	5905339296412	2,5	15	135	1800	320	E14	A+
XLED A60 5W-SW	29642	5905339296429	5	23	230	1800	320	E27	A
XLED ST64 5W-SW	29643	5905339296436	5	26	270	1800	320	E27	A
XLED G95 5W-SW	29644	5905339296443	5	28	290	1800	320	E27	A+
XLED G125 5W-SW	29645	5905339296450	5	28	290	1800	320	E27	A+

[V]	[Hz]	FILAMENT	elliptic ≤ 60° nach oben	Ra	≥ 80	≥ 15000	15000	320	Hg	CE	ERC
220-240 AC	50										



XLED C35T 2,5W-SW

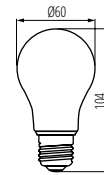

XLED A60 5W-SW



XLED ST64 5W-SW

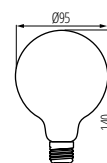

XLED G95 5W-SW

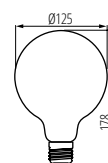

XLED G125 5W-SW

Kanlux

IQ-LED C37

ŹRÓDŁO ŚWIATŁA LED ► LED LIGHT SOURCE



IQ-LED C37E14 5,5W



IQ-LED C37E14 5,5W



IQ-LED C37E14 7,5W



Kanlux IQ-LED to bezpieczeństwo fotobiologiczne, przyjazna oczom temperatura barwowa i niezawodność, a to wszystko zachowane w klasycznym designie C37. Żarówki IQ-LED zapewniają pełen komfort użytkowania oraz bezpieczeństwo, które potwierdza certyfikat TÜV Rheinland.

Material: tworzywo sztuczne

The Kanlux IQ-LED means photobiological safety and eye-friendly colour temperature and reliability, all in the classic C37 design. IQ-LED bulbs provide full comfort of use and safety, which is confirmed by the TÜV Rheinland certificate.

Material: plastic

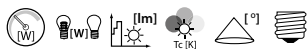

IQ-LED C37E14 5,5W-WW	27294	5905339272942	5,5	40	470	2700	280	E14
IQ-LED C37E14 5,5W-NW	27295	5905339272959	5,5	41	490	4000	280	E14
IQ-LED C37E14 5,5W-CW	27296	5905339272966	5,5	41	490	6500	280	E14
IQ-LED C37E14 7,5W-WW	27297	5905339272973	7,5	60	810	2700	280	E14
IQ-LED C37E14 7,5W-NW	27298	5905339272980	7,5	61	830	4000	280	E14
IQ-LED C37E14 7,5W-CW	27299	5905339272997	7,5	61	830	6500	280	E14

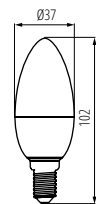

IQ-LED C37E14 5,5W

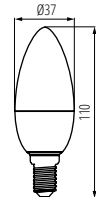

IQ-LED C37E14 7,5W



Kanlux

XLED C35

ŹRÓDŁO ŚWIATŁA LED ► LED LIGHT SOURCE



XLED C35E14 4,5W



XLED C35E14 2,5W



XLED C35E14 4,5W

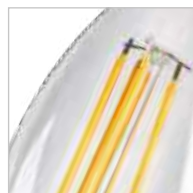

Kanlux XLED łączy w sobie najlepsze cechy tradycyjnych żarówek i nowoczesnych źródeł światła LED. Dlatego mówimy o nim, że to pierwsza prawdziwa „żarówka LED”. Szklana bańka w kształcie tradycyjnej „świeczki” i diody LED rozmieszczone w taki sposób, że światło rozchodzi się we wszystkich kierunkach, a kąt świecenia wynosi nawet 320 stopni!

Materiał klosza: szkło

Kanlux XLED combines the best features of traditional bulbs and modern LED light sources. Therefore, we talk about it as the first real LED bulb. A glass bulb in the shape of a traditional “candle” and LED diodes placed in such a way so that light can part in all directions, and the angle of light comes to even 320 degrees!

Lampshade material: glass



XLED C35E14 2,5W-WW	29617	5905339296177	2,5	25	250	2700	320	E14
XLED C35E14 4,5W-WW	29618	5905339296184	4,5	40	470	2700	320	E14
XLED C35E14 4,5W-NW	29619	5905339296191	4,5	40	470	4000	320	E14

[V] 220-240 AC	[Hz] 50	FILAMENT	Ra ≥80	h ≥15000	h 15000	Hg No	EI A++	CE	ERC
--------------------------	-------------------	-----------------	------------------	--------------------	-------------------	-----------------	------------------	-----------	------------

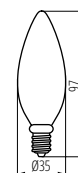

XLED C35E14 2,5W; 4,5W

Kanlux

XLED C35M

ŹRÓDŁO ŚWIATŁA LED ► LED LIGHT SOURCE



XLED C35E14 4,5W, XLED C35E14 6W



XLED C35E14 4,5W, XLED C35E14 6W



XLED C35E27 6W-M

NEW



Kanlux XLED łączy w sobie najlepsze cechy tradycyjnych żarówek i nowoczesnych źródeł światła LED. Dlatego mówimy o nim, że to pierwsza prawdziwa „żarówka LED”. Matowa bańka w kształcie tradycyjnej „świecek” i diody LED rozmieszczone w taki sposób, że światło rozchodzi się we wszystkich kierunkach, a kąt świecenia wynosi nawet 320 stopni!

Materiał klosza: szkło

Kanlux XLED combines the best features of traditional bulbs and modern LED light sources. Therefore, we talk about it as the first real LED bulb. A mat bulb in the shape of a traditional “candle” and LED diodes placed in such a way so that light can part in all directions, and the angle of light comes to even 320 degrees!

Lampshade material: glass



	[W]	[W]	[lm]	Tc (K)	[°]	[h]	[h]		
XLED C35E14 4,5W-WW-M	29620	5905339296207	4,5	40	470	2700	320	E14	15000
XLED C35E14 4,5W-NW-M	29621	5905339296214	4,5	40	470	4000	320	E14	15000
XLED C35E14 6W-WW-M	29622	5905339296221	6	60	810	2700	320	E14	10000
XLED C35E14 6W-NW-M	29623	5905339296238	6	60	810	4000	320	E14	10000
XLED C35E27 6W-WW-M	29646	5905339296467	6	60	810	2700	320	E27	10000
XLED C35E27 6W-NW-M	29647	5905339296474	6	60	810	4000	320	E27	10000

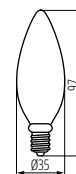

XLED C35E14 4,5W, XLED C35E14 6W

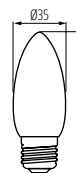

XLED C35E27 6W-M

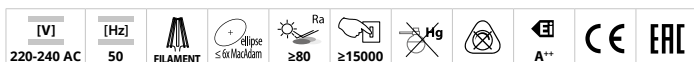

DUN LED

ŹRÓDŁO ŚWIATŁA LED ► LED LIGHT SOURCE



DUN 4,5W T SMD E14



DUN 4,5W T SMD E14



DUN 6,5W T SMD E14



Niewielkich rozmiarów Kanlux DUN to żarówka typu „świeczka” o trzonku E14. Trwałość tych źródeł została uzyskana dzięki połączeniu diod LED SMD i ceramicznej obudowy. Kanlux DUN charakteryzują się dużą wydajnością świetlną. Ddoskonale nadają się do kinkietów i żyrandoli we wszystkich miejscach gdzie pomimo niewielkiego źródła chcemy uzyskać dużo światła.

Material: tworzywo sztuczne

The small-size Kanlux DUN is a “candle-type” bulb with E14 screw. Durability of these light sources results from the combination of LED SMD diodes and ceramic housing. Kanlux DUN are characterised by high luminous efficiency. They are perfect for wall lamps and chandeliers in all places where we want to get a lot of light even though its source is small.

Material: plastic

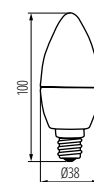

DUN 4,5W T SMD E14

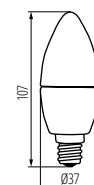

DUN 6,5W T SMD E14

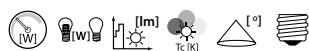

	[W]	[Hz]	SMD	ellipse ≤60° Nachdäm	Ra	≥15000	20000	Mg	RoHS	CE	EAC
DUN 4,5W T SMD E14-WW	23380	5905339233806	4,5	35	400	3000	230	E14			
DUN 4,5W T SMD E14-NW	23381	5905339233813	4,5	35	400	4000	230	E14			
DUN 6,5W T SMD E14-WW	23430	5905339234308	6,5	48	600	3000	210	E14			
DUN 6,5W T SMD E14-NW	23431	5905339234315	6,5	48	600	4000	210	E14			

[V]	[Hz]	SMD	ellipse ≤60° Nachdäm	Ra	≥15000	20000	Mg	RoHS	CE	EAC
220-240 AC	50			≥80						

IDO LED

ŹRÓDŁO ŚWIATŁA LED ► LED LIGHT SOURCE



IDO 4,5WT SMD E14



IDO 4,5WT SMD E14



IDO 6,5WT SMD E14



Kanlux IDO to źródła w kształcie „świeczki” o trzonku E14. Te LEDowe źródła charakteryzują się dużym kątem świecenia (wersja 4,5 W - 230°, a wersja 6,5 W - 210°), wyróżnia je również ozdobny kształt.

Materiał: tworzywo sztuczne

Kanlux IDO are candle-shaped sources with a E14 screw. These LED sources are characterised by large illumination angle (4,5W-230°, 6,5W -210°) and their decorative shape.

Materiał: plastic



IDO 4,5WT SMD E14

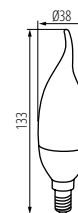

IDO 6,5WT SMD E14

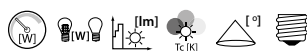

IDO 4,5WT SMD E14-WW	23382	5905339233820	4,5	35	400	3000	230	E14
IDO 4,5WT SMD E14-NW	23383	5905339233837	4,5	35	400	4000	230	E14
IDO 6,5WT SMD E14-WW	23490	5905339234902	6,5	48	600	3000	210	E14
IDO 6,5WT SMD E14-NW	23491	5905339234919	6,5	48	600	4000	210	E14

[V]	[Hz]	SMD	ellipse ≤ 60° nach dem	Ra	≥80	≥15000	20000	Mg	A*	CE	ERC
-----	------	-----	---------------------------	----	-----	--------	-------	----	----	----	-----

IQ-LED G45

ŹRÓDŁO ŚWIATŁA LED ▶ LED LIGHT SOURCE



IQ-LED G45E14 5,5W



IQ-LED G45E27 5,5W



IQ-LED G45E14 7,5W



IQ-LED G45E27 7,5W



Safety
Regular
Production
Surveillance

www.tuv.com
ID 0000055711



Kanlux IQ-LED to bezpieczeństwo fotobiologiczne, przyjazna oczom temperatura barwowa i niezawodność, a to wszystko zachowane w klasycznym designie G45. Żarówki IQ-LED zapewniają pełen komfort użytkowania oraz bezpieczeństwo, które potwierdza certyfikat TÜV Rheinland.

Materiał: tworzywo sztuczne

Materiał klosza: tworzywo sztuczne

The Kanlux IQ-LED means photobiological safety and eye-friendly colour temperature and reliability, all in the classic G45 design. IQ-LED bulbs provide full comfort of use and safety, which is confirmed by the TÜV Rheinland certificate.

Materiał: plastic

Lampshade material: plastic

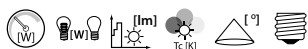

Model	Code	Power [W]	Frequency [Hz]	Beam Angle [°]	Ra	Lifespan [h]	Mercury-free	RoHS	CE	ENEC
IQ-LED G45E14 5,5W-WW	27300	5,5	40	470	2700	220	E14			
IQ-LED G45E14 5,5W-NW	27301	5,5	41	490	4000	220	E14			
IQ-LED G45E14 5,5W-CW	27302	5,5	41	490	6500	220	E14			
IQ-LED G45E27 5,5W-WW	27303	5,5	40	470	2700	220	E27			
IQ-LED G45E27 5,5W-NW	27304	5,5	41	490	4000	220	E27			
IQ-LED G45E27 5,5W-CW	27305	5,5	41	490	6500	220	E27			
IQ-LED G45E14 7,5W-WW	27306	7,5	60	810	2700	200	E14			
IQ-LED G45E14 7,5W-NW	27307	7,5	61	830	4000	200	E14			
IQ-LED G45E14 7,5W-CW	27308	7,5	61	830	6500	200	E14			
IQ-LED G45E27 7,5W-WW	27309	7,5	60	810	2700	200	E27			
IQ-LED G45E27 7,5W-NW	27310	7,5	61	830	4000	200	E27			
IQ-LED G45E27 7,5W-CW	27311	7,5	61	830	6500	200	E27			

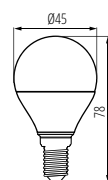

IQ-LED G45E14 5,5W

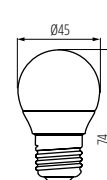

IQ-LED G45E27 5,5W

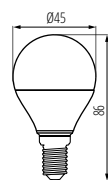

IQ-LED G45E14 7,5W

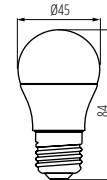

IQ-LED G45E27 7,5W

[V]	[Hz]	SMD	Beam angle	Ra	Lifespan	Hg-free	RoHS	CE	ENEC
220-240 AC	50		≤ 60°	≥ 80	≥ 40000	15000		A*	

Kanlux

XLED G45

ŹRÓDŁO ŚWIATŁA LED ► LED LIGHT SOURCE



XLED G45 E14 4,5W

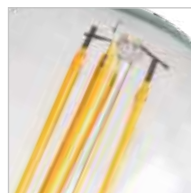

Kanlux XLED łączy w sobie najlepsze cechy tradycyjnych żarówek i nowoczesnych źródeł światła LED. Dlatego mówimy o nim, że to pierwsza prawdziwa „żarówka LED”. Szklana bańka w kształcie tradycyjnej „kulki” i diody LED rozmieszczone w taki sposób, że światło rozchodzi się we wszystkich kierunkach. Do wyboru mamy źródła z trzonkiem E27 i E14.

Materiał klosza: szkło

Kanlux XLED combines the best features of traditional bulbs and modern LED light sources. Therefore, we talk about it as the first real LED bulb. A glass bulb in the shape of a traditional “ball” and LED diodes placed in such a way so that light can part in all directions. You choose from sources with E27 and E14 light bulb bases.

Lampshade material: glass



XLED G45 E14 4,5W



XLED G45 E27 4,5W

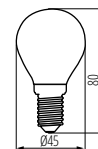

XLED G45 E14 4,5W

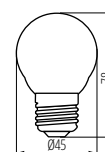

XLED G45 E27 4,5W

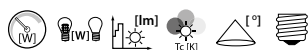

XLED G45 E14 4,5W-WW	29624	5905339296245	4,5	40	470	2700	320	E14
XLED G45 E27 4,5W-WW	29625	5905339296252	4,5	40	470	2700	320	E27

[V]	[Hz]	FILAMENT	ellipse ≤ 60° nach 2dm	Ra	≥80	≥15000	15000	Mg	⊗	A**	CE	EAC
220-240 AC	50											

XLED G45M

ŹRÓDŁO ŚWIATŁA LED ► LED LIGHT SOURCE



XLED G45M E14 4,5W; 6W



XLED G45M E14 4,5W; 6W



XLED G45M E27 4,5W; 6W



Kanlux XLED łączy w sobie najlepsze cechy tradycyjnych żarówek i nowoczesnych źródeł światła LED. Dlatego mówimy o nim, że to pierwsza prawdziwa „żarówka LED”. Matowa bańka w kształcie tradycyjnej „kulki” i diody LED rozmieszczone w taki sposób, że światło rozchodzi się we wszystkich kierunkach. Do wyboru mamy źródła z trzonkiem E27 i E14.

Materiał klosza: szkło

Kanlux XLED combines the best features of traditional bulbs and modern LED light sources. Therefore, we talk about it as the first real LED bulb. A mat bulb in the shape of a traditional "ball" and LED diodes placed in such a way so that light can part in all directions. You choose from sources with E27 and E14 light bulb bases.

Lampshade material: glass

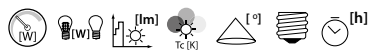

	[V]	[W]	[lm]	Tc (K)	[°]	[h]			
XLED G45E144,5W-WW-M	29626	5905339296269	4,5	40	470	2700	320	E14	15000
XLED G45E144,5W-NW-M	29627	5905339296276	4,5	40	470	4000	320	E14	15000
XLED G45 E14 6W-WW-M	29628	5905339296283	6	60	810	2700	320	E14	10000
XLED G45 E14 6W-NW-M	29629	5905339296290	6	60	810	4000	320	E14	10000
XLED G45E27 4,5W-WW-M	29630	5905339296306	4,5	40	470	2700	320	E27	15000
XLED G45E27 4,5W-NW-M	29631	5905339296313	4,5	40	470	4000	320	E27	15000
XLED G45 E27 6W-WW-M	29632	5905339296320	6	60	810	2700	320	E27	10000
XLED G45 E27 6W-NW-M	29633	5905339296337	6	60	810	4000	320	E27	10000

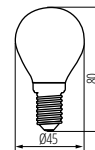

XLED G45M E14 4,5W; 6W

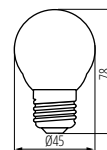

XLED G45M E27 4,5W; 6W

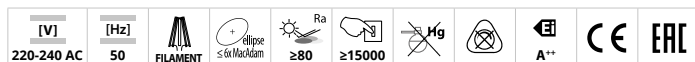

BILO LED

ŹRÓDŁO ŚWIATŁA LED ► LED LIGHT SOURCE

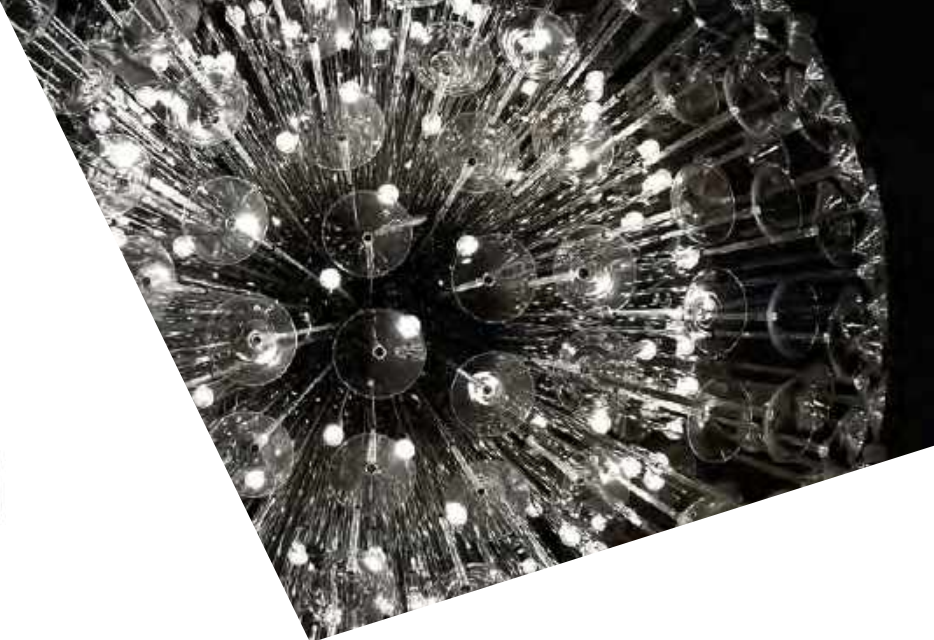

BILO 3W; 5W T SMD E14



BILO 3W; 5W T SMD E14



BILO 3W; 5W T SMD E27



BILO 6,5W T SMD E27



Kanlux BILO to trwałość, która została uzyskana dzięki innowacyjnej technologii LED SMD oraz ceramicznej obudowie. Wszystkie modele Kanlux BILO charakteryzują się dużą wydajnością świetlną. Te źródła „kulki” źródła doskonale nadają się do kinkietów i żyrandoli we wszystkich miejscach, gdzie znaczenie ma estetyka i duża ilość światła.

Lampshade material: tworzywo sztuczne

Kanlux BILO ensures durability which was obtained thanks to innovative LED SMD technology and ceramic housing. All Kanlux BILO models are characterised by high luminous efficiency. These sources with E14 screw and “ball” shape are perfect for sconces and chandeliers in all places where aesthetics and large amounts of light are important.

Lampshade material: plastic

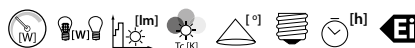

BILO 3W T SMD E14-WW	23040	5905339230409	3	27	280	3000	200	E14	25000	A++
BILO 3W T SMD E27-WW	23041	5905339230416	3	27	280	3000	200	E27	25000	A++
BILO 5W T SMD E14-WW	23042	5905339230423	5	37	420	3000	200	E14	25000	A+
BILO 5W T SMD E27-WW	23043	5905339230430	5	37	420	3000	200	E27	25000	A+
BILO 6,5W T SMD E27-WW	23420	5905339234209	6,5	48	600	3000	200	E27	20000	A+
BILO 6,5W T SMD E27-NW	23421	5905339234216	6,5	48	600	4000	200	E27	20000	A+
BILO 6,5W T SMD E14-WW	23422	5905339234223	6,5	48	600	3000	200	E14	20000	A+
BILO 6,5W T SMD E14-NW	23423	5905339234230	6,5	48	600	4000	200	E14	20000	A+

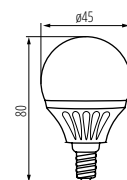

BILO 3W; 5W T SMD E14

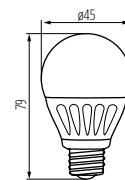

BILO 3W; 5W T SMD E27

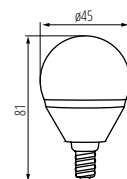

BILO 6,5W T SMD E14

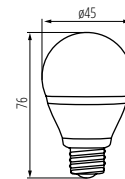

BILO 6,5W T SMD E27

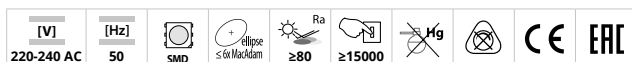

BILO HI LED

ŹRÓDŁO ŚWIATŁA LED ► LED LIGHT SOURCE



BILO HI 8W E14



BILO HI 8W E14



BILO HI 8W E27



SUPER HIGH
lumen

CERAMIC
body

IC driver

Kanlux BILO HI to trwałość, która została uzyskana dzięki innowacyjnej technologii LED SMD oraz ceramicznej obudowie. Wszystkie modele Kanlux BILO HI charakteryzują się dużą wydajnością świetlną, gdyż przy poborze mocy 8W emitują światło o strumieniu 800 lm. Te źródła o trzonku E14 i kształcie „kulki” źródła doskonale nadają się do kinkietów i żyrandoli we wszystkich miejscach, gdzie znaczenie ma estetyka i duża ilość światła przy niewielkiej mocy.

Materiał: ceramika

Materiał klosza: tworzywo sztuczne

Kanlux BILO HI ensures durability which was obtained thanks to innovative LED SMD technology and ceramic housing. All Kanlux BILO HI models are characterised by high luminous efficiency since they emit light of 800 lm beam at 8W power consumption. These sources with E14 screw and "ball" shape are perfect for sconces and chandeliers in all places where aesthetics and large amounts of light at low power are important.

Materiał: ceramika

Lampshade material: plastic

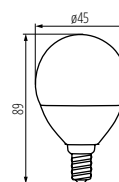

BILO HI 8W E14

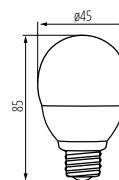

BILO HI 8W E27



Model	Code	Part No.	Power [W]	Frequency [Hz]	Beam Angle [°]	Luminous Flux [lm]	Temp. [K]	Beam Spread [°]	Lifespan [h]	Base
BILO HI 8W E14-WW	26762	5905339267627	8	60	800	3000	210	E14		
BILO HI 8W E14-NW	26763	5905339267634	8	60	800	4000	210	E14		
BILO HI 8W E27-WW	26764	5905339267641	8	60	800	3000	210	E27		
BILO HI 8W E27-NW	26765	5905339267658	8	60	800	4000	210	E27		

[V] 220-240 AC	[Hz] 50	SMD	Beam angle ≤ 60°/120°/180°	Ra ≥ 80	Lifespan ≥ 15000	17500	Hg	RoHS	A+	CE	ERC
-------------------	------------	-----	-------------------------------	------------	---------------------	-------	----	------	----	----	-----

Kanlux

IQ-LED GU10



ŹRÓDŁO ŚWIATŁA LED ► LED LIGHT SOURCE



IQ-LED GU10 5W



IQ-LED GU10 5W



IQ-LED GU10 7W



Safety
Regular
Production
Surveillance

www.tuv.com
ID 0000056711



Kanlux IQ-LED to bezpieczeństwo fotobiologiczne, przyjazna oczom temperatura barwowa i niezawodność. Teraz to wszystko w nowej wersji z trzonkiem GU10. Żarówki IQ-LED zapewniają pełen komfort użytkowania oraz bezpieczeństwo, które potwierdza certyfikat TÜV Rheinland.

Materiał klosza: tworzywo sztuczne

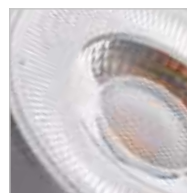

Kanlux IQ-LED means photo-biological safety, colour temperature friendly to eyes and reliability. Now, all this in a new version with GU10 light bulb base. IQ-LED bulbs ensure full comfort of use and safety, which is confirmed by TÜV Rheinland certificate.

Lampshade material: plastic

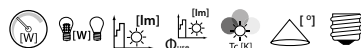

			[W]	[lm]	[lm]	[°]			
IQ-LED GU10 5W-WW	29803	5905339298034	5	31	370	335	2700	120	GU10
IQ-LED GU10 5W-NW	29804	5905339298041	5	31	380	340	4000	120	GU10
IQ-LED GU10 5W-CW	29805	5905339298058	5	31	380	340	6500	120	GU10
IQ-LED GU10 7W S3-WW	29806	5905339298065	7	75	580	535	2700	36	GU10
IQ-LED GU10 7W S3-NW	29807	5905339298072	7	75	580	535	4000	36	GU10
IQ-LED GU10 7W S3-CW	29808	5905339298089	7	75	580	535	6500	36	GU10
IQ-LED GU10 7W-WW	29809	5905339298096	7	43	580	520	2700	120	GU10
IQ-LED GU10 7W-NW	29810	5905339298102	7	43	580	520	4000	120	GU10
IQ-LED GU10 7W-CW	29811	5905339298119	7	43	580	520	6500	120	GU10

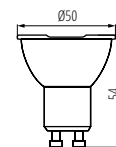

IQ-LED GU10 5W

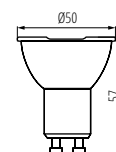

IQ-LED GU10 7W



Kanlux

IQ-LEDIM GU10

ŹRÓDŁO ŚWIATŁA LED ► LED LIGHT SOURCE



IQ-LEDIM GU10 7,5W

Kanlux IQ-LED to bezpieczeństwo fotobiologiczne, przyjazna oczom temperatura barwowa i niezawodność. Teraz to wszystko w nowej wersji z trzonkiem GU10 - dodatkowo wersja IQ-LEDIM współpracuje ze ściemniaczami. Żarówki IQ-LED zapewniają pełen komfort użytkowania oraz bezpieczeństwo, które potwierdza certyfikat TÜV Rheinland

Materiał klosza: tworzywo sztuczne

Kanlux IQ-LED means photo-biological safety, colour temperature friendly to eyes and reliability. Now, all this in a new version with GU10 light bulb base - additionally, the IQ-LEDIM version cooperates with dimmers. IQ-LED bulbs ensure full comfort of use and safety, which is confirmed by TÜV Rheinland certificate

Lampshade material: plastic

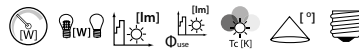

IQ-LEDIM GU10 7,5W-WW	29812	5905339298126	7,5	42	570	510	2700	120	GU10
IQ-LEDIM GU10 7,5W-NW	29813	5905339298133	7,5	42	570	510	4000	120	GU10
IQ-LEDIM GU10 7,5W-CW	29814	5905339298140	7,5	42	570	510	6500	120	GU10

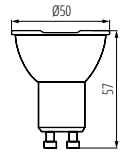

IQ-LEDIM GU10 7,5W

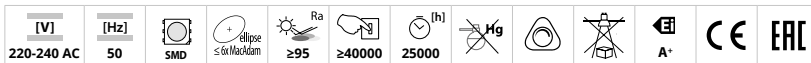

Kanlux

REMI LED

ŹRÓDŁO ŚWIATŁA LED ► LED LIGHT SOURCE

NEW



REMI LED GU10



LEDowe źródła światła Kanlux REMI LED przeznaczone są do opraw oświetleniowych o niewielkich rozmiarach. Ich kąt świecenia to 120°. Żarówka ta wyróżnia się małym kształtem, dlatego świetnie sprawdzi się w zgrabnych, małych lampach.

Materiał: tworzywo sztuczne

LED light sources Kanlux REMI LED are designed for small-size luminaires. Their illumination angle is 120°. The bulb is distinguished by its small size so it will be useful for neat, small lamps.

Materiał: plastic

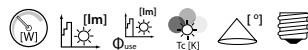

REMI LED GU10-NW	33080	5905339330802	2,2	200	165	4000	120	GU10
REMI LED GU10-WW	33081	5905339330819	2,2	180	150	3000	120	GU10

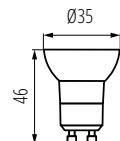

REMI LED GU10

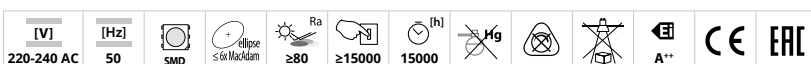

TOMI LED

ŹRÓDŁO ŚWIATEŁA LED ► LED LIGHT SOURCE



TOMI LED 1,2W; 7W GU10



TOMI LED 1,2W; 7W GU10



TOMI LED 3W; 5W GU10



W źródłach Kanlux TOMI LED zastosowano hybrydową konstrukcję radiatora, dzięki czemu wymiana ciepła z otoczeniem jest dużo efektywniejsza. Ponadto biały kolor obudowy Kanlux TOMI LED sprawia, że to źródło jest ciekawe wzorniczo. Światło w tych źródłach jest równomiernie rozprowadzane przez zastosowanie matowego klosza.

Materiał klosza: tworzywo sztuczne

Kanlux TOMI LED sources use hybrid heat sink construction thanks to which heat exchange with the environment is much more effective. Moreover, white colour of Kanlux TOMI LED housing makes the source's design interesting. The light in these sources is evenly distributed by the use of matt shade.

Lampshade material: plastic

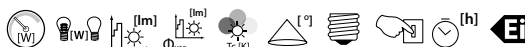

	[W]	[lm]	[°]	[h]	EI							
TOMI LED1,2W GU10-WW	22708	5905339227089	1,2	10	90	80	3000	120	GU10	≥25000	25000	A++
TOMI LED1,2W GU10-NW	22822	5905339228222	1,2	10	90	80	4000	120	GU10	≥25000	25000	A++
TOMI LED1,2W GU10-CW	22709	5905339227096	1,2	10	90	80	5300	120	GU10	≥25000	25000	A++
TOMI LED3W GU10-WW	22702	5905339227027	3	25	250	200	3000	120	GU10	≥15000	20000	A++
TOMI LED3W GU10-NW	22823	5905339228239	3	26	260	210	4000	120	GU10	≥15000	20000	A++
TOMI LED3W GU10-CW	22703	5905339227034	3	26	270	220	5300	120	GU10	≥15000	20000	A++
TOMI LED5W GU10-WW	22700	5905339227003	5	33	360	290	3000	120	GU10	≥15000	20000	A+
TOMI LED5W GU10-NW	22824	5905339228246	5	33	370	300	4000	120	GU10	≥15000	20000	A+
TOMI LED5W GU10-CW	22701	5905339227010	5	34	380	300	5300	120	GU10	≥15000	20000	A+
TOMI LED7W GU10-WW	22821	5905339228215	7	42	500	400	3000	120	GU10	≥15000	20000	A+
TOMI LED7W GU10-NW	22825	5905339228253	7	42	510	410	4000	120	GU10	≥15000	20000	A+
TOMI LED7W GU10-CW	22820	5905339228208	7	43	520	410	5300	120	GU10	≥15000	20000	A+

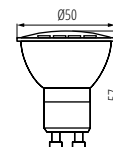

TOMI LED 1,2W; 7W GU10

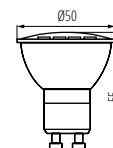

TOMI LED 3W; 5W GU10

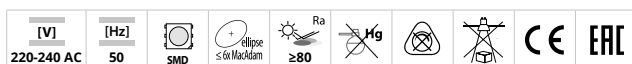

Kanlux FULLED

ŹRÓDŁO ŚWIATŁA LED ► LED LIGHT SOURCE



FULLED GU10-3,3W



Cechą wyróżniającą Kanlux FULLED jest wygląd zbliżony do tradycyjnych, szklanych halogenów, uzyskany dzięki przezroczystej obudowie z tworzywa. Zastosowanie specjalnej soczewki zapewnia również efekt świecenia zbliżony do tradycyjnego halogenu. Dodatkową zaletą tych lamp jest ich kąt świecenia wynoszący 120° umożliwiający szerokokątne oświetlenie wybranej powierzchni.

Materiał klosza: tworzywo sztuczne

The appearance similar to the traditional glass halogens, obtained owing to the transparent plastic housing, is the distinguishing feature of Kanlux FULLED. The use of special lens also ensures a lighting effect similar to traditional halogen. Another advantage of these lamps is their illumination angle of 120° allowing for a wide-angle illumination of the selected surface.

Lampshade material: plastic

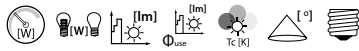

			[W]	[lm]	[lm]	[lm]	[lm]	[°]	
FULLED GU10-3,3W-WW	26033	5905339260338	3,3	27	275	235	2700	120	GU10
FULLED GU10-3,3W-NW	26034	5905339260345	3,3	27	285	240	4000	120	GU10
FULLED GU10-3,3W-CW	26035	5905339260352	3,3	28	295	250	6500	120	GU10

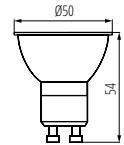

FULLED GU10-3,3W



Kanlux TEDI MAXX LED

ŹRÓDŁO ŚWIATŁA LED ► LED LIGHT SOURCE



TEDI MAXX LED GU10



Kanlux TEDI MAXX LED to moc zamknięta w niewielkim korpusie. Wydajne diody LED oraz ceramiczna obudowa to tylko niektóre atuty tych źródeł. Stabilizowany zasilacz zapewnia zminimalizowanie efektu migotania, który mógłby męczyć wzrok. Ponadto Kanlux TEDI MAXX to wydajność świetlna 100lm z Wata, a zastosowana matowa szklka zapewnia równomierny rozsył światła.

Materiał: ceramika

Materiał klosza: tworzywo sztuczne

The Kanlux TEDI MAXX is power enclosed in a small body. Efficient LED's and ceramic casing are just two of the advantages of this light source. The stabilised power supply minimises the flicker effect, which could cause eye fatigue. In addition, The Kanlux TEDI MAXX has a light output of 100lm per 1 Watt, and the matte glass used ensures uniform light distribution

Materiał: ceramics

Lampshade material: plastic



			[W]	[lm]	[lm]	[lm]	[lm]	[°]	
TEDI MAXX LED GU10-WW	23412	5905339234124	9	66	900	710	3000	120	GU10
TEDI MAXX LED GU10-NW	23414	5905339234148	9	66	900	710	4000	120	GU10
TEDI MAXX LED GU10-CW	23413	5905339234131	9	66	900	710	6000	120	GU10

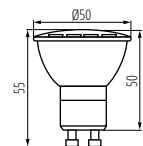

TEDI MAXX LED GU10

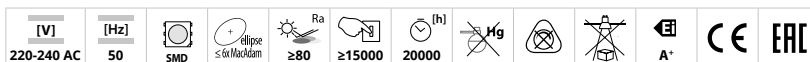

Kanlux LED15 C

ŹRÓDŁO ŚWIATŁA LED ► LED LIGHT SOURCE



LED15 C MR16

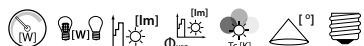

Model	Code	Power (W)	Beam Angle (°)	Luminous Flux (lm)	Operating Temp (K)	Life (h)	Beam Angle (°)	Base
LED15 C MR16-WW-B	22203	4,5	34	380	315	3000	120	Gx5,3
LED15 C MR16-CW-B	22204	4,5	35	390	325	6500	120	Gx5,3

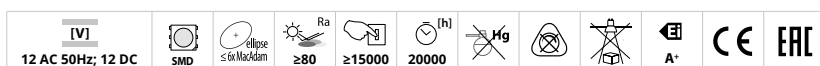

Kanlux LED15 C to źródło światła z trzonkiem MR16. Źródła te charakteryzują się wysoką trwałością, która wynosi 20.000 godzin. Bezpośredni wpływ na wydłużenie ich żywotności ma także ich ceramiczna obudowa, która bardzo dobrze odprowadza ciepło generowane przez diody.

Materiał: ceramika

Materiał klosza: szkło

Kanlux LED15 C is a source of light with MR16 screw cap. These sources are characterised by high durability amounting to 20,000 hours. Their ceramic housing that very well dissipates the heat generated by the diodes also has a direct impact on extending their life.

Material: ceramics

Lampshade material: glass

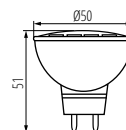

LED15 C MR16

Kanlux TOMI LED

ŹRÓDŁO ŚWIATŁA LED ► LED LIGHT SOURCE



TOMI LED 5W; 7W MR16

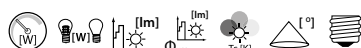

Model	Code	Power (W)	Beam Angle (°)	Luminous Flux (lm)	Operating Temp (K)	Life (h)	Beam Angle (°)	Base
TOMI LED5W MR16-WW	22704	5	33	370	300	3000	120	Gx5,3
TOMI LED5W MR16-CW	22705	5	35	390	310	5300	120	Gx5,3
TOMI LED7W MR16-WW	22706	7	41	480	385	3000	120	Gx5,3
TOMI LED7W MR16-CW	22707	7	42	500	400	5300	120	Gx5,3



Kanlux TOMI LED to trwałe źródło LED typu MR16 o klasycznym wyglądzie. W źródłach Kanlux TOMI LED zastosowano hybrydową konstrukcję radiatora (warstwa termotworzywa + aluminiowy wkład), dzięki czemu wymiana ciepła z otoczeniem jest dużo efektywniejsza, a trwałość źródła wynosi 25.000h. Matowa szybka równomiernie rozprasza światło, którego kąt padania wynosi 120°.

Materiał klosza: tworzywo sztuczne

Kanlux TOMI LED are MR16 type solid LED sources of classic look. Kanlux TOMI LED sources use hybrid heat sink construction thanks to which heat exchange with the environment is much more effective. The matt glass evenly diffuses the light with its illumination angle amounting to 120°.

Lampshade material: plastic

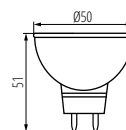

TOMI LED 5W MR16

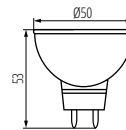

TOMI LED 7W MR16

SIGO LED

ŹRÓDŁO ŚWIATŁA LED ► LED LIGHT SOURCE



SIGO R39 LED E14



Kanlux SIGO LED to nie tylko oszczędność energii, ale też trwałość 15-krotnie wyższa niż w tradycyjnych żarówkach reflektorowych. Ponieważ ich kształt i rozmiar przypomina standardowe żarówki reflektorowe, łatwo je wymienić bez konieczności żadnych dodatkowych modyfikacji.

Materiał klosza: tworzywo sztuczne

Kanlux SIGO LED is both energy-efficient and 15 times more durable than traditional reflector bulbs. Since their shape and size resembles standard reflector bulbs, they are easily replaceable without additional modifications.

Lampshade material: plastic



SIGO R39 LED E14



SIGO R50 LED E14



SIGO R63 LED E27

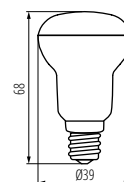

SIGO R39 LED E14

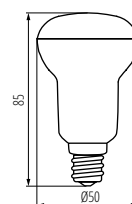

SIGO R50 LED E14

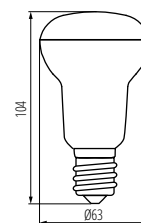

SIGO R63 LED E27



SIGO R39 LED E14-WW	22733	5905339227331	4	30	320	3000	120	E14
SIGO R39 LED E14-NW	22734	5905339227348	4	30	320	4000	120	E14
SIGO R50 LED E14-WW	22735	5905339227355	6	41	480	3000	120	E14
SIGO R50 LED E14-NW	22736	5905339227362	6	41	480	4000	120	E14
SIGO R63 LED E27-WW	22737	5905339227379	8	50	640	3000	120	E27
SIGO R63 LED E27-NW	22738	5905339227386	8	50	640	4000	120	E27

[V]	[Hz]	[SMD]	[Ra]	[h]	[A*]	[CE]	[EAC]
220-240 AC	50		≥80	≥15000	15000		

Kanlux GIO LED G9

ŹRÓDŁO ŚWIATŁA LED ► LED LIGHT SOURCE



GIO LED G9

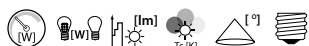

GIO LED G9-WW	22660	5905339226600	2,5	21	200	3000	290	G9
GIO LED G9-NW	22661	5905339226617	2,5	21	200	5000	290	G9

[V] 220-240 AC	[Hz] 50	SMD	ellipse ≤ 60 MacAdam	Ra ≥ 80	lm ≥ 15000	[h] 25000	Hg	RoHS	IEC A++	CE	ERC
--------------------------	-------------------	------------	--------------------------------	-------------------	----------------------	---------------------	-----------	-------------	-------------------	-----------	------------



Kanlux GIO LED G9 to małe źródło o kącie świecenia 290°. Wysokowydajne źródła o trzonku G9 mają również bardzo długą żywotność, która wynosi 25.000 godzin.

Materiał: tworzywo sztuczne

Kanlux GIO LED G9 are small sources with illumination angle of 290°. These highly effective sources with G9 screw are also very durable - their lifetime equals to 25,000 hours.

Materiał: plastic

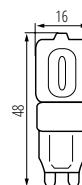

GIO LED G9

Kanlux G9 GLASS

ŹRÓDŁO ŚWIATŁA LED ► LED LIGHT SOURCE



G9 GLASS LED2W

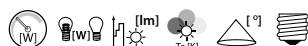

G9 GLASS LED2W-WW	26630	5905339266309	2	21	200	3000	320	G9
G9 GLASS LED2W-CW	26631	5905339266316	2	21	200	6000	320	G9

[V] 220-240 AC	[Hz] 50	COB	ellipse ≤ 60 MacAdam	Ra ≥ 80	lm ≥ 15000	[h] 15000	Hg	RoHS	IEC A++	CE	ERC
--------------------------	-------------------	------------	--------------------------------	-------------------	----------------------	---------------------	-----------	-------------	-------------------	-----------	------------

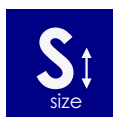

Kanlux G9 GLASS LED2 dzięki szklanej bańce do złudzenia przypominają tradycyjne źródła. Konstrukcja źródeł Kanlux G9 GLASS gwarantuje szeroki kąt emisji światła i dzięki temu idealnie nadaje się do zastosowania we wszelkich otwartych oprawach i żyrandolach.

Materiał: szkło

Owing to the glass bubble, Kanlux G9 GLASS LED2 are strikingly similar to traditional sources. The construction of Kanlux G9 GLASS sources guarantees a wide light emission angle, owing to which they are perfect for all open luminaires and chandeliers.

Materiał: glass

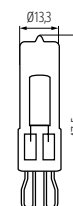

G9 GLASS LED2W

ZUBI LED

ŹRÓDŁO ŚWIATŁA LED ► LED LIGHT SOURCE



ZUBI LED 3,5W G9



ZUBI MAX LED 3,5W G9



ZUBI HI LED 4W G9



ZUBI LED 3,5W E14



HIGH
lumen

CERAMIC
body

LED
technology

Kanlux ZUBI LED to energooszczędne źródła, dodatkowe zalety użytkowe tych źródeł to niewielkie rozmiary a także mleczny klosz, który ogranicza efekt oślnienia oraz zapewnia elegancki i estetyczny wygląd. Konstrukcja źródeł Kanlux ZUBI gwarantuje szeroki kąt emisji światła, dzięki temu idealnie nadaje się do zastosowania we wszelkich otwartych oprawkach i żyrandolach.

Materiał: ceramika

Materiał klosza: tworzywo sztuczne

Kanlux ZUBI LED are energy-saving sources. Their additional functional benefits include the small size and the milky lampshade reducing the glare effect. They provide smart and aesthetic look. The construction of Kanlux ZUBI sources guarantees a wide light emission angle, owing to which they are perfect for all open luminaires and chandeliers.

Materiał: ceramika

Lampshade material: plastic



ZUBI LED 3,5W G9-WW	24520	5905339245205	3,5	28	300	3000	320	G9	≥10000	A+
ZUBI LED 3,5W G9-CW	24521	5905339245212	3,5	28	300	6000	320	G9	≥10000	A+
ZUBI MAX LED3,5WG9-WW	24522	5905339245229	3,5	35	400	3000	320	G9	≥10000	A++
ZUBI HI LED4WG9-WW	24524	5905339245243	4	42	500	3000	280	G9	≥15000	A++
ZUBI LED 3,5W E14-WW	24525	5905339245250	3,5	28	300	3000	300	E14	≥10000	A+

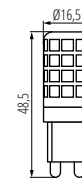

ZUBI LED 3,5W G9

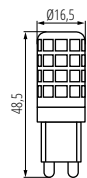

ZUBI MAX LED3,5WG9

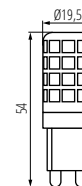

ZUBI HI LED4WG9

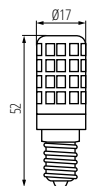

ZUBI LED 3,5W E14

[VI]	[Hz]	SMD	diode ≤ 60 Mackdam	Ra ≥80	[h]	Hg	[RoHS]	CE	EAC
220-240 AC	50				15000				

Kanlux GIO LED G4

ŹRÓDŁO ŚWIATŁA LED ► LED LIGHT SOURCE



GIO LED G4 FL

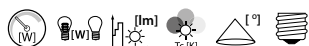

GIO LED G4 FL-WW	22662	5905339226624	1,3	11	100	3000	250	G4
GIO LED G4 FL-NW	22663	5905339226631	1,3	11	100	5000	250	G4

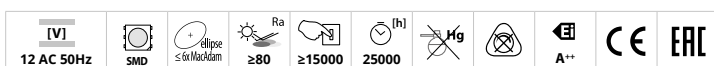

12
voltage

S
size

LED
techno
logy

Kanlux GIO LED G4 to małe źródło o kącie świecenia 250°. Wysokowydajne źródła o trzonku G4 mają również bardzo długą żywotność, która wynosi 25.000 godzin.

Materiał: tworzywo sztuczne

Kanlux GIO LED G4 are small sources with illumination angle of 250°. These highly effective sources with G4 screw are also very durable - their lifetime is 25,000 hours.

Materiał: plastic

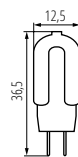

GIO LED G4 FL

Kanlux TANO G4 SMD

ŹRÓDŁO ŚWIATŁA LED ► LED LIGHT SOURCE



TANO G4 SMD

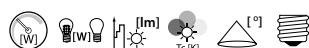

TANO G4 SMD-WW	14936	5907540962483	1,5	11	100	3000	300	G4
----------------	--------------	---------------	-----	----	-----	------	-----	----



12
voltage

300°

S
size

Kanlux TANO LED to źródło światła o trzonku G4. Wysokowydajne źródło ma bardzo szeroki kąt świecenia (300°), świetnie sprawdzi się w kinkietach, lampkach nocnych czy innych oprawach, do których pasują źródła z trzonkiem G4.

Materiał: tworzywo sztuczne

Kanlux TANO LED are light sources with G4 screw. This highly durable source has a very wide illumination angle (300°), perfect for sconces, lamps and other night luminaires matching light source with G4 screw.

Materiał: plastic

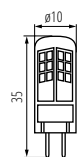

TANO G4 SMD

Kanlux

LED 12 G4

ŹRÓDŁO ŚWIATŁA LED ► LED LIGHT SOURCE

NEW



LED12 G4



12
voltage

S ↑
size

up to
140 lm
W

Kanlux LED12 G4 to kapsułka LED oparta na nowych, bardzo wydajnych diodach LED. Kąt świecenia źródła to 120°, jego trwałość wynosi 20.000 godzin, a wydajność to aż 140 lumenów z wata.

Kanlux LED12 G4 is an LED capsule based on new, high-performance LEDs. The source's lighting angle is 120°, its life is 20 000 hours, and the efficiency is as much as 140 lm/W.

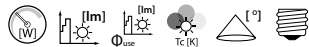

LED12 G4-WW	18502	5905339185020	1,2	165	135	3000	120	G4
LED12 G4-NW	18503	5905339185037	1,2	170	140	4000	120	G4

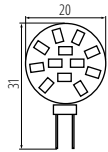

LED12 G4

IV1
12 AC 50Hz; 12 DC

SMD

≤ 6μ MacAdam

Ra ≥ 80

≥ 20000

20000

Hg

RoHS

A++

CE

ERC



Kanlux

AR-111 LED

ŹRÓDŁO ŚWIATŁA LED ► LED LIGHT SOURCE



AR-111 LED SL/SR



AR-111 LED SL/W



AR-111 LED SL/SR

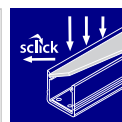

Kanlux AR-111 LED to LEDowa wersja źródeł halogenowych jednak ich wzornictwo odbiega od klasycznego wyglądu halogenów. Kanlux AR-111 LED charakteryzują się długą trwałością i niskim zużyciem energii.

Źródło polecamy wszędzie tam, gdzie jest widoczne ze względu na jego walory dekoracyjne. Cechą wyróżniającą te źródła jest zastosowanie markowych diod EPISTAR, co gwarantuje najwyższą jakość światła

Dla zapewnienia poprawnej pracy lamp należy zastosować zasilacz LED o mocy min. 2x większej niż przewidziane obciążenie obwodu.

Materiał klosza: tworzywo sztuczne

Kanlux AR-111 LED is a LED version of halogen sources. However, their design differs from the classic look of halogens. Kanlux AR-111 LED are characterised by long durability and low energy consumption. The source is recommended in all places where it is visible due to its decorative values. These light sources stand out with the use of brand EPISTAR diodes, which ensured the highest light quality.

To ensure proper work of the lamps a LED power supply of at least twice the power than the circuit load projected should be used.

Lampshade material: plastic

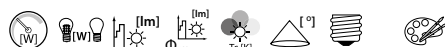

AR-111 LED SL/WW/W	22960	5905339229601	11	66	900	710	2700	40	G53	biały white
AR-111 LED SL/WW/SR	22962	5905339229625	11	66	900	710	2700	40	G53	srebrny silver
AR-111 LED SL/NW/SR	22968	5905339229687	11	66	900	710	4000	40	G53	srebrny silver

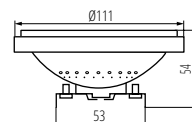
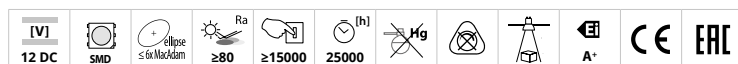

AR-111 LED SL

ES-111 LED

ŹRÓDŁO ŚWIATŁA LED ► LED LIGHT SOURCE



ES-111 LED SL/SR



ES-111 LED SL/W



ES-111 LED SL/SR

Kanlux ES-111 LED to LEDowa wersja źródeł halogenowych jednak ich wzornictwo odbiega od klasycznego wyglądu halogenów. Kanlux ES-111 LED charakteryzują się długą trwałością i niskim zużyciem energii. Źródło polecamy wszędzie tam, gdzie jest widoczne ze względu na jego walory dekoracyjne. Cechą wyróżniającą te źródła jest zastosowanie markowych diod EPISTAR, co gwarantuje najwyższą jakość światła.

Materiał klosza: tworzywo sztuczne

Kanlux ES-111 LED is a LED version of halogen sources. However, their design differs from the classic look of halogens. Kanlux ES-111 LED are characterised by long durability and low energy consumption. The source is recommended in all places where it is visible due to its decorative values. These light sources stand out with the use of brand EPISTAR diodes, which ensured the highest light quality.

Lampshade material: plastic

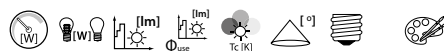

Model	Code	Part No.	W	H	Φ	Φ _{use}	T _c [K]	Beam Angle [°]	Beam Height [mm]	Beam Spread [mm]	Color
ES-111 LED SL/WW/W	22970	5905339229700	11	66	900	730	2700	40	GU10	biały white	
ES-111 LED SL/WW/SR	22972	5905339229724	11	66	900	730	2700	40	GU10	srebrny silver	
ES-111 LED SL/NW/SR	22978	5905339229786	11	66	900	730	4000	40	GU10	srebrny silver	

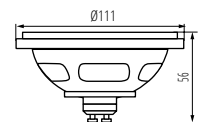

ES-111 LED SL

[V]	[Hz]	SMD	≤ 6x MacAdam	Ra ≥ 80	≥ 15000	25000 [h]	Hg	RoHS	A+	CE	EAC
-----	------	-----	--------------	---------	---------	-----------	----	------	----	----	-----

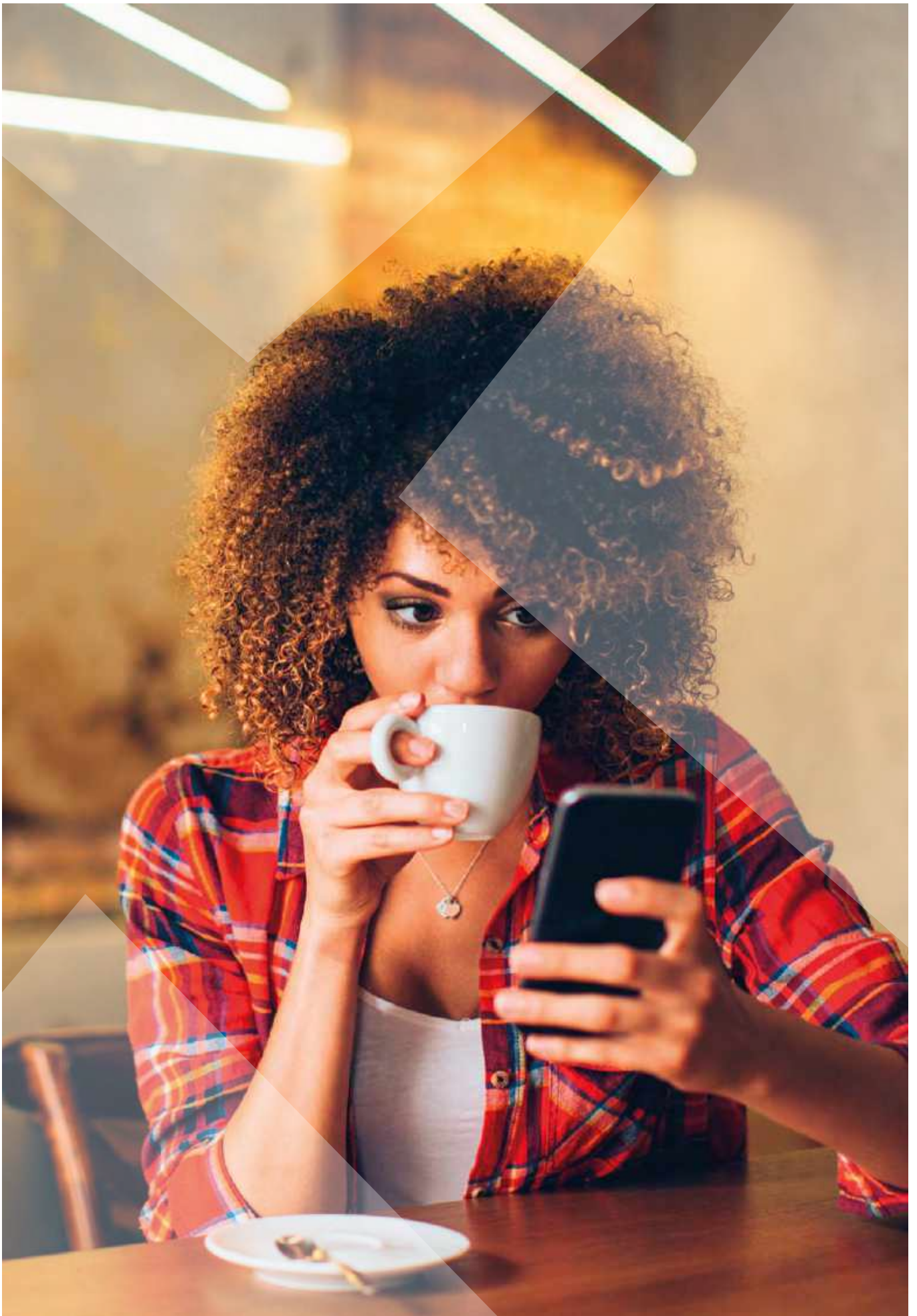

T8 LED GLASSV2

ŹRÓDŁO ŚWIATŁA LED ► LED LIGHT SOURCE



T8 LED GLASSV2



HIGH
lumen

GLASS
tube

IC
driver

PF
>0,9
high

Kanlux T8 LED GLASS to znana i sprawdzona linia świetlówek oparta na wysokowydajnych diodach LED SMD, które umieszczone są w mlecznym, szklanym korpusie. Wysoka jakość wykonania i dbałość o najlepszej klasy komponenty to najważniejsze cechy T8 LED GLASSV2.

Jednostronne zasilanie świetlówek LED
Materiał klosza: szkło

Kanlux T8 LED GLASS is a renown and well-proven line of fluorescent lamps based on high-efficiency SMD LEDs, placed in a milky, glass body. High quality of manufacture and care for the best quality components are the most important features of T8 LED GLASSV2.

One-way fluorescent LED-power supply
Lampshade material: glass

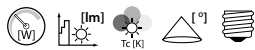

T8 LED GLASSV2 9W-WW	22658	5905339226587	9	1080	3000	200	G13
T8 LED GLASSV2 9W-NW	22654	5905339226549	9	1080	4000	200	G13
T8 LED GLASSV2 9W-CW	22659	5905339226594	9	1080	6500	200	G13
T8 LED GLASSV2 18W-WW	22656	5905339226563	18	2160	3000	200	G13
T8 LED GLASSV2 18W-NW	22655	5905339226556	18	2160	4000	200	G13
T8 LED GLASSV2 18W-CW	26060	5905339260604	18	2160	6500	200	G13
T8 LED GLASSV2 24W-NW	22657	5905339226570	24	2880	4000	200	G13
T8 LED GLASSV2 24W-CW	26061	5905339260611	24	2880	6500	200	G13

[V] 220-240 AC	[Hz] 50	SMD	ellipse ≤60° MacAdam	Ra ≥80	≥15000	[h] 25000	Hg
		A+	ONE SIDE INPUT	-10+40	CE	EAC	

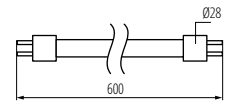

T8 LED GLASSV2 9W

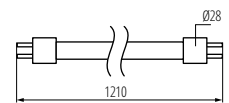

T8 LED GLASSV2 18W

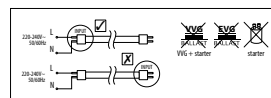

OR

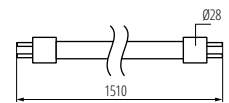
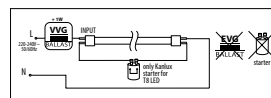

T8 LED GLASSV2 24W

T8 LED GLASSV3

ŹRÓDŁO ŚWIATŁA LED ► LED LIGHT SOURCE



T8 LED GLASSV3



up to
140 $\frac{\text{lm}}{\text{W}}$

PF >0.9
high

IC driver

GLASS tube

Kanlux T8 LED GLASS to znana i sprawdzona linia świetlówek oparta na wysokowydajnych diodach LED SMD, które umieszczone są w mlecznym, szklanym korpusie. Wysoka jakość wykonania i dbałość o najlepszej klasy komponenty to najważniejsze cechy T8 LED GLASSV3.

Jednostronne zasilanie świetlówek LED
Materiał klosza: szkło

The Kanlux T8 LED GLASS is a well-known and proven line of fluorescent lamps utilising high-performance SMD LED's in a milky-coloured glass body. The high quality of workmanship and the care taken over choosing the best-quality components are the most-important features of the T8 LED GLASSV3.

One-way fluorescent LED-power supply
Lampshade material: glass

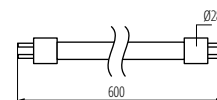

T8 LED GLASSV3 9W

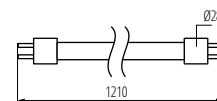

T8 LED GLASSV3 18W

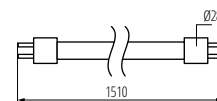

T8 LED GLASSV3 24W

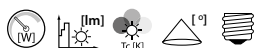

T8 LED GLASSV3 9W-NW	26062	5905339260628	9	1260	4000	250	G13
T8 LED GLASSV3 9W-CW	26063	5905339260635	9	1260	6500	250	G13
T8 LED GLASSV3 18W-NW	26064	5905339260642	18	2520	4000	250	G13
T8 LED GLASSV3 18W-CW	26065	5905339260659	18	2520	6500	250	G13
T8 LED GLASSV3 24W-NW	26066	5905339260666	24	3360	4000	250	G13
T8 LED GLASSV3 24W-CW	26067	5905339260673	24	3360	6500	250	G13

[V] 220-240 AC	[Hz] 50	SMD	ellipse ≤ 60°/klosz	Ra ≥80	≥15000	(h) 25000	Hg
		A**	ONE SIDE INPUT	°C -10÷40	CE	ERAC	

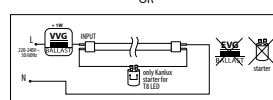
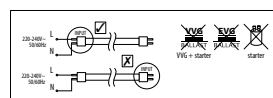

Kanlux

T8 LED GLASSV3T

ŹRÓDŁO ŚWIATŁA LED ► LED LIGHT SOURCE



T8 LED GLASSV3T



up to
145 $\frac{\text{lm}}{\text{W}}$

PF >0,9
high

IC
driver

GLASS
tube

Kanlux T8 LED GLASS to znana i sprawdzona linia świetlówek oparta na wysokowydajnych diodach LED SMD. Kanlux T8 LED GLASSV3T znajduje się w transparentnym, szklanym korpusie. Nowe modele charakteryzują się wyższą skutecznością świetlną i węższym kątem emisji światła wynoszącym 120°.

Jednostronne zasilanie świetlówek LED
Materiał klosza: szkło

The Kanlux T8 LED GLASS is a well-known and proven line of fluorescent lamps utilising high-performance SMD LED's. The Kanlux T8 LED GLASSV3T is fitted in a transparent glass body. The new models have a higher luminous efficacy and the narrower light-emission angle of 120°.

One-way fluorescent LED-power supply
Lampshade material: glass

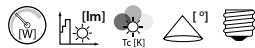

T8LED GLASSV3T 18W NW | **26068** | 5905339260680 | 18 | 2610 | 4000 | 120 | G13

[V] 220-240 AC	[Hz] 50	SMD	≤ 6x Nachdam	Ra ≥ 80	≥ 15000	25000	Hg
		EI A**	ONE SIDE INPUT	°C -10÷40	CE	ERC	

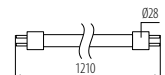
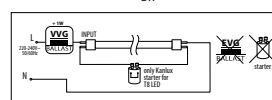
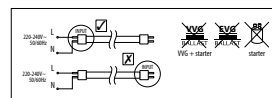

T8LED GLASSV3T

T8 GLASSV4

ŹRÓDŁO ŚWIATŁA LED ► LED LIGHT SOURCE

NEW



T8 LED GLASSV4



3
WARRANTY
3 years

up to
160 lm/W

PF > 0,9
high

GLASS
tube

Kanlux T8 LED GLASS to znana i sprawdzona linia świetlówek oparta na wysokowydajnych diodach LED, które umieszczone są w mlecznym, szklanym korpusie, przez co równomiernie emitują światło. Wysoka jakość wykonania i dbałość o najlepszej klasy komponenty to najważniejsze cechy T8 LED GLASSV4. Ponadto te wyjątkowe świetlówki LEDowe to 3 lata gwarancji i skuteczność świetlna aż do 160 lumenów z Wata.

3 lat Gwarancji na warunkach oświadczenia gwarancyjnego, dostępnego na stronie internetowej

Jednostronne zasilanie świetlówek LED

Materiał klosza: szkło

Kanlux T8 LED GLASS is a well-known and proven line of fluorescent lamps based on high-performance LED diodes, which are placed in a milky, glass body, thanks to which they evenly emit light. High-quality workmanship and care for the best-class components are the most important features of Kanlux T8 LED GLASSV4. In addition, these unique LED lamps have a 3-year warranty and a luminous efficacy of up to 160 lumens from Watt.

3 years Warranty under the terms of the warranty statement, available on our website

One-way fluorescent LED-power supply

Lampshade material: glass

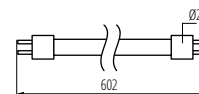

T8 LED GLASSV4 9W

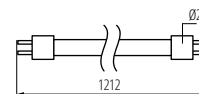

T8 LED GLASSV4 18W

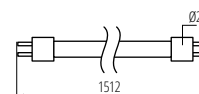

T8 LED GLASSV4 24W

T8 LED GLASSV4 9W-NW	33210	590533932103	9	1440	4000	220 G13
T8 LED GLASSV4 9W-CW	33211	590533932110	9	1440	6500	220 G13
T8 LED GLASSV4 18W-NW	33212	590533932127	18	2880	4000	220 G13
T8 LED GLASSV4 18W-CW	33213	590533932134	18	2880	6500	220 G13
T8 LED GLASSV4 24W-NW	33214	590533932141	24	3840	4000	220 G13
T8 LED GLASSV4 24W-CW	33215	590533932158	24	3840	6500	220 G13

220-240 AC	50	SMD	Ra ≥ 80	30000	
A+	ONE SIDE INPUT		-10/+40		

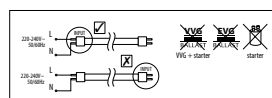

OR

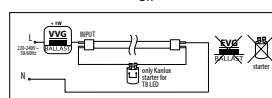



ESG LED 9W GX53



HIGH
lumen

IC
driver

LED
technology

Kanlux ESG LED charakteryzuje się estetycznym wykonaniem i trwałą konstrukcją. Matowy klosz gwarantuje równomierny i szeroki rozsył światła. Biała obudowa wykonana z aluminium zapewnia prawidłowe odprowadzenie ciepła, a wysokowydajne diody LED SMD trwałość 20000h.

Materiał: stop aluminium, tworzywo sztuczne

Kanlux ESG LED is characterised by aesthetic design and durable construction. The matte shade guarantees an even and wide light distribution. White housing made of aluminium ensures proper heat dissipation and high performance SMD LEDs ensure durability for 20,000 h.

Materiał: aluminum alloy, plastic



[V]	[Hz]	[lm]	[lm]	[W]	[K]	[°]	[h]	[mm]	[mm]
220-240 AC	50	SMD	≤ 6 (Machdam)	≥ 80	≥ 15000	20000			
ESG LED 9W GX53-WW	22422	5905339224224	9	55	720	575	3000	110	GX53
ESG LED 9W GX53-NW	22423	5905339224231	9	57	750	600	4000	110	GX53
ESG LED 9W GX53-CW	22424	5905339224248	9	57	750	600	6000	110	GX53

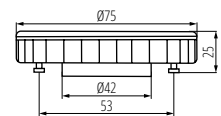
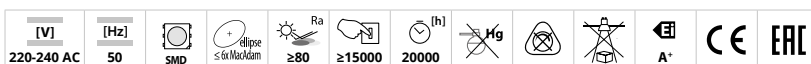

ESG LED 9W GX53

Kanlux

MODV2 LED

ŹRÓDŁO ŚWIATEŁA LED ► LED LIGHT SOURCE



MODV2 LED 12W



MODV2 LED 12W



MODV2 LED 19W



HIGH
lumen

LED
techno
logy

EASY
instala
tion

Kanlux MOD LED to profesjonalna seria modułów LED przeznaczona do modyfikacji lamp, w których mieliśmy starego typu żarówki. Moduł charakteryzuje się łatwością montażu. Kanlux MOD LED to wysokiej jakości diody LED SMD, które wyróżniają się energooszczędnością i długim czasem działania.

Materiał klosza: tworzywo sztuczne

Kanlux MOD LED is a professional series of LED modules designed for modification of lamps which used the old type of light bulbs. The module can be installed easily. Kanlux MOD LED are high-quality SMD LEDs, distinguished by energy efficiency and long lifetime.

Lampshade material: plastic



Model	Power (W)	Power Factor (PF)	Luminous Flux (lm)	Beam Angle (°)	Life (h)	Temp. (°C)	Temp. (°F)
MODV2 LED 12W-WW	29300	5905339293008	12	83	1200	3000	170
MODV2 LED 12W-NW	29301	5905339293015	12	83	1200	4000	170
MODV2 LED 19W-WW	29302	5905339293022	19	120	1900	3000	170
MODV2 LED 19W-NW	29303	5905339293039	19	120	1900	4000	170

[V]	[Hz]	SMD	ellipso sól MacAdam	Ra	≥80	≥15000	18000	Mg	RoHS	CE	EAC
220-240 AC	50								A+		

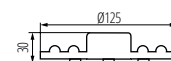

MODV2 LED 12W

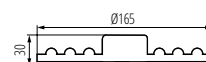

MODV2 LED 19W

Kanlux

RANGO LED

ŹRÓDŁO ŚWIATŁA LED ► LED LIGHT SOURCE



Ledowe źródło Kanlux RANGO to idealne rozwiązanie energooszczędne dla wszelkiego rodzaju lamp i naświetlaczy o trzonku R7s.

Materiał klosza: tworzywo sztuczne
Materiał klosza: szkło

LED source Kanlux RANGO is the perfect energy-saving solution for all types of lamps and floodlights with R7s screw.

Lampshade material: plastic
Lampshade material: glass



RANGO R7S SMD



RANGO MINI R7S SMD

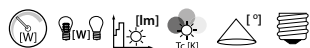

RANGO R7S SMD-WW	15098	5907540962155	6	42	500	3000	120	R7s
RANGO MINI R7S SMD-WW	15099	5907540962568	6	42	500	3000	120	R7s

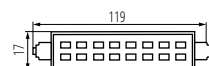
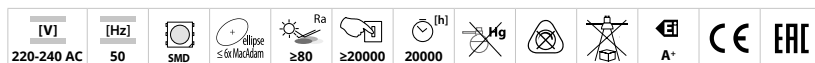

RANGO R7S SMD

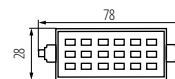

RANGO MINI R7S SMD



Kanlux LEDS-B

TAŚMA LED ► LED TAPE



LEDS-B 4.8W/M IP00



Kanlux LEDS-B to nowoczesne paski o charakterze dekoracyjnym. Idealne do zastosowań domowych, gdzie mogą stworzyć niepowtarzalne aranżacje ograniczone tylko przez naszą wyobraźnię. Charakteryzują się dużą elastycznością, dobrą przyczepnością i wysoką trwałością. W zależności od tego jakie miejsca chcemy doświetlić lub podkreślić możemy wybrać odpowiednią do naszych upodobań barwę światła.

Kanlux LEDS-B are modern strips of decorative character. Perfect for home use where they can create unique arrangements limited by our imagination only. They are characterised by high flexibility, good adhesion and high durability. Depending on the place in which we want to add more light or which we wish to highlight, we can choose the light colour suiting our preferences.

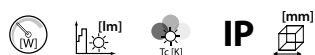

LEDS-B 4,8W/M IP00-CW	24518	5905339245182	1m = 4,8	1m = 500	6500	00	5000			
LEDS-B 4,8W/M IP00-NW	24517	5905339245175	1m = 4,8	1m = 470	4000	00	5000			
LEDS-B 4,8W/M IP00-WW	24516	5905339245168	1m = 4,8	1m = 450	3000	00	5000			
LEDS-B 4,8W/M IP54-CW	24512	5905339245120	1m = 4,8	1m = 320	6000-7500	54	5000			
LEDS-B 4,8W/M IP54-NW	24511	5905339245113	1m = 4,8	1m = 300	4000-5500	54	5000			
LEDS-B 4,8W/M IP54-WW	24510	5905339245106	1m = 4,8	1m = 270	3300-3900	54	5000			
LEDS-B 4,8W/M IP65-CW	24515	5905339245151	1m = 4,8	1m = 450	6500	65	5000			
LEDS-B 4,8W/M IP65-NW	24514	5905339245144	1m = 4,8	1m = 425	4000	65	5000			
LEDS-B 4,8W/M IP65-WW	24513	5905339245137	1m = 4,8	1m = 400	3000	65	5000			



AKCESORIA ► ACCESSORIES

CONNECTOR 8	19030	5905339190307	Konektor do taśmy LED, CONNECTOR 8 (19030) LED band connector, CONNECTOR 8 (19030)
CONNECTOR 8-CP	19032	5905339190321	Konektor do taśmy LED, CONNECTOR 8-CP (19032) LED band connector, CONNECTOR 8-CP (19032)
CONNECTOR 8-CPC	19033	5905339190338	Konektor do taśmy LED, CONNECTOR 8-CPC (19033) LED band connector, CONNECTOR 8-CPC (19033)

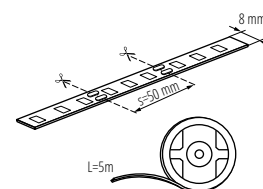

LEDS-B 4,8W-M

LED STRIP L60

TAŚMA LED ▶ LED TAPE



L60 11W/M 12



Taśma Kanlux L60 to dwie wersje szczelności IP00 i IP65 - dla miejsc, gdzie taśma narażona jest na wilgoć. Wersja IP65, nie różni się znacznie gabarytami od wersji IP00 - ma to znaczenie przy montażu w profilach aluminiowych. Taśmy Kanlux L60 bardzo wysoki współczynnik oddawania barw CRI 90 i aż trzy lata gwarancji. Dodatkowo wersja Kanlux L60B to rolki o długości 30 metrów - dla tych, którzy potrzebują większych ilości taśm LED.

3 lat Gwarancji na warunkach oświadczenia gwarancyjnego, dostępnego na stronie internetowej

Kanlux L60 LED strip that's two IP rates, IP00 and IP65 - for places where the tape is exposed to moisture. IP65 version, does not differ significantly in size from the IP00 version - this is important when mounting in aluminum profiles. Kanlux L60 tapes very high color rendering factor CRI 90 and up to 3 Years warranty. In addition, the Kanlux L60B version is a 30-meter long roll for those who need longer LED strips.

3 years Warranty under the terms of the warranty statement, available on our website

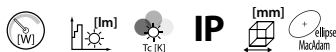

Model	Code	Part No.	1m =	1m =	3000	00	5000	≤3
L60 11W/M 12 IP00-WW	33302	5905339333025	1m = 11	1m = 900	3000	00	5000	≤3
L60 11W/M 12 IP00-NW	33303	5905339333032	1m = 11	1m = 900	4000	00	5000	≤3
L60 11W/M 12 IP00-CW	33304	5905339333049	1m = 11	1m = 900	6000	00	5000	≤3
L60B 11W/M 12 IP00-WW	33305	5905339333056	1m = 11	1m = 900	3000	00	30000	≤3
L60B 11W/M 12 IP00-NW	33306	5905339333063	1m = 11	1m = 900	4000	00	30000	≤3
L60B 11W/M 12 IP00-CW	33307	5905339333070	1m = 11	1m = 900	6000	00	30000	≤3
L60 11W/M 12 IP65-WW	33308	5905339333087	1m = 11	1m = 800	3000	65	5000	≤6
L60 11W/M 12 IP65-NW	33309	5905339333094	1m = 11	1m = 800	4000	65	5000	≤6
L60 11W/M 12 IP65-CW	33310	5905339333100	1m = 11	1m = 800	6000	65	5000	≤6

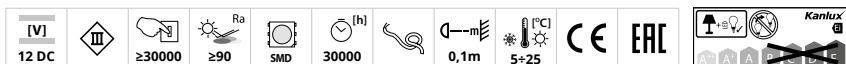
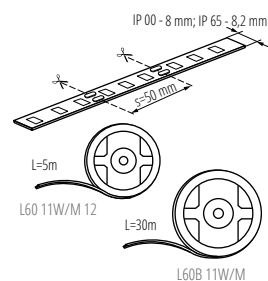

LED STRIP L120

TAŚMA LED ▶ LED TAPE



L120 16W/M 24



3

WARRANTY
3 years

up to

120 ^{lm}/_W

24V

Taśma Kanlux L120 to dwie wersje szczelności IP00 i IP65 - dla miejsc, gdzie taśma narażona jest na wilgoć. Wersja IP65, nie różni się znacznie gabarytami od wersji IP00 - ma to znaczenie przy montażu w profilach aluminiowych. Taśmy Kanlux L120 to wysoka skuteczność świetlna (do 120 lumenów z wata) i aż trzy lata gwarancji.

3 lat Gwarancji na warunkach oświadczenia gwarancyjnego, dostępnego na stronie internetowej

Kanlux L120 LED strip that's two IP rates, IP00 and IP65 - for places where the tape is exposed to moisture. IP65 version, does not differ significantly in size from the IP00 version - this is important when mounting in aluminum profiles. Kanlux L120 tapes are high luminous efficiency (up to 120 lm/W) and up to 3 Year warranty.

3 years Warranty under the terms of the warranty statement, available on our website

						IP		
L120 16W/M 24 IP00-WW	33311	5905339333117	1m=16	1m = 1760	3000	00	5000	≤3
L120 16W/M 24 IP00-NW	33312	5905339333124	1m=16	1m = 1920	4000	00	5000	≤3
L120 16W/M 24 IP00-CW	33313	5905339333131	1m=16	1m = 1920	6000	00	5000	≤3
L120B 16W/M 24 IP00-WW	33355	5905339333551	1m=16	1m = 1760	3000	00	30000	≤3
L120B 16W/M 24 IP00-NW	33356	5905339333568	1m=16	1m = 1920	4000	00	30000	≤3
L120B 16W/M 24 IP00-CW	33357	5905339333575	1m=16	1m = 1920	6000	00	30000	≤3
L120 16W/M 24 IP65-WW	33314	5905339333148	1m=16	1m = 1600	3000	65	5000	≤6
L120 16W/M 24 IP65-NW	33315	5905339333155	1m=16	1m = 1760	4000	65	5000	≤6
L120 16W/M 24 IP65-CW	33316	5905339333162	1m=16	1m = 1760	6000	65	5000	≤6

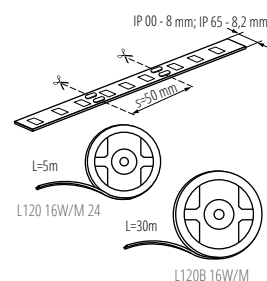

[V]

III

≥30000

Ra ≥80

SMD

30000

0,1m

5+25

CE

EAC

LED STRIP LCOB

TAŚMA LED ► LED TAPE



LCOB 9W/M 12



3
WARRANTY
3 years

up to

110 $\frac{\text{lm}}{\text{W}}$

3M
tape

Taśma LEDowa Kanlux LCOB to wyjątkowe oświetlenie. Ma bardzo wysoką skuteczną świetlną (do 110 lumenów z wata) i 3 lata gwarancji. Jednak jej unikatową cechą jest świecenie na całej długości - nie ma na niej jaśniejszych lub ciemniejszych miejsc, nie widać punktów świetlnych. Taśma Kanlux LCOB emituje równomierne światło niezależnie od głębokości profilu i przezroczystości klosza.

3 lat Gwarancji na warunkach oświadczenia gwarancyjnego, dostępnego na stronie internetowej

Kanlux LCOB LED tape is unique. It has a very high effective light (110 lm/W) and 3 Year warranty. However, its unique feature is the full length of light - there are no brighter or darker places on it, you can not see the light points. Kanlux LCOB tape emits even light regardless of the depth of the profile and the transparency of the shade if they are installed in the profiles.

3 years Warranty under the terms of the warranty statement, available on our website

						IP	
LCOB 9W/M 12IP00-WW	33300	5905339333001	1m = 9	1m = 900	3000	00	5000
LCOB 9W/M 12IP00-NW	33301	5905339333018	1m = 9	1m = 1000	4000	00	5000

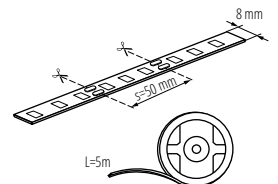

LCOB 9W/M 12

Kanlux

LED STRIP L120 CCT

TAŚMA LED ▶ LED TAPE

NEW



Taśma Kanlux L120 CCT to trzy barwy światła w jednej taśmie. Teraz możesz zmieniać barwę światła zależnie od sytuacji i nastroju, ponadto Kanlux L120 CCT to bardzo wysoki współczynnik oddawania barw CRI 90 i aż trzy lata gwarancji.

3 lat Gwarancji na warunkach oświadczenia gwarancyjnego, dostępnego na stronie internetowej

Do prawidłowego działania wymagany jest kontroler i pilot (CTRL 12/24V 10A CCT 22142, REMOTE CCT 22145), dostępne one są w ofercie KANLUX

Kanlux L120 CCT LED strip that's three colors of light in one tape. Now you can change the color of the light depending on the situation and mood, in addition, the Kanlux L120 CCT is a very high color rendering factor CRI 90 and up to 3 Year warranty.

3 years Warranty under the terms of the warranty statement, available on our website
Proper controller and remote (CTRL 12/24V 10A CCT 22142, REMOTE CCT 22145) available in Kanlux offer are required for correct operation.

L120 16W/M 12



L120 16W/M 12.IP00CCT | **33317** | 5905339333179 | 1m=16 | 1m = max 1300 | 3000-6000 | 00 | 5000

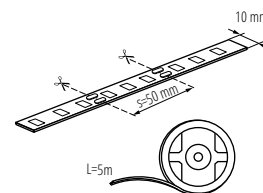
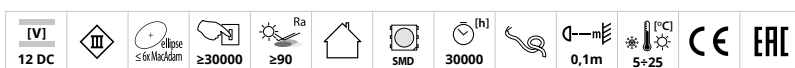

L120 16W/M 12

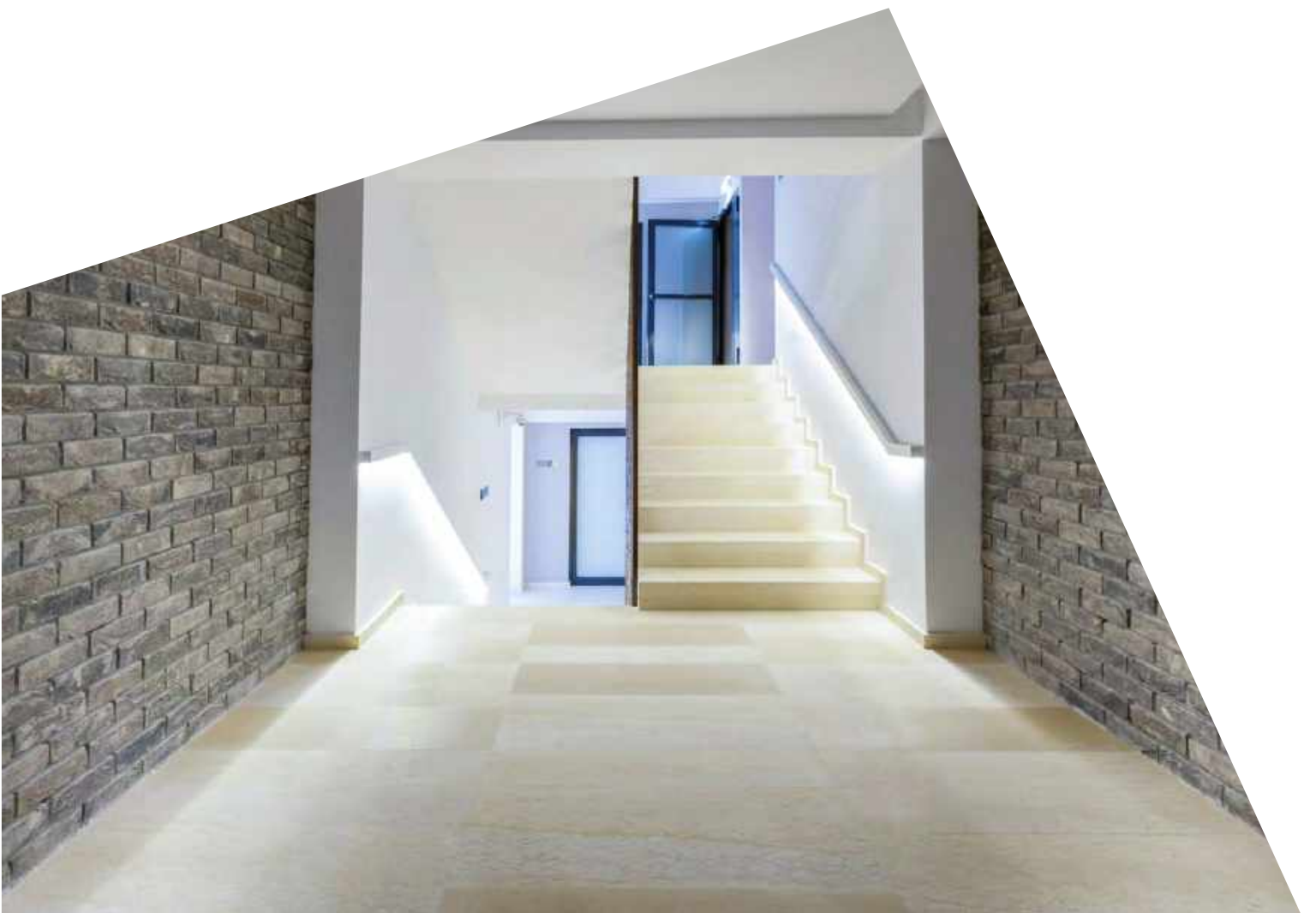

LEDS-B RGB

TAŚMA LED ▶ LED TAPE



LEDS-B 7.2W/M IP00RGB



Kanlux LEDSB RGB to nowoczesne paski o charakterze dekoracyjnym. Idealne do zastosowań domowych, gdzie mogą stworzyć niepowtarzalne aranżacje ograniczone tylko przez naszą wyobraźnię. Charakteryzują się dużą elastycznością, dobrą przyczepnością i wysoką trwałością. W zależności od tego jakie miejsca chcemy doświetlić lub podkreślić możemy wybrać odpowiedni do naszych upodobań kolor świecenia.

Kanlux LEDSB RGB are modern strips of decorative character. Perfect for home use where they can create unique arrangements limited by our imagination only. They are characterised by high flexibility, good adhesion and high durability. Depending on the place in which we want to add more light or which we wish to highlight, we can choose the lighting colour suiting our preferences.

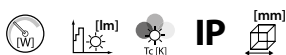

LEDS-B 7,2W/M IP00RGB	24530	5905339245304	1m = 7,2	1m = 130	RGB	00	5000
LEDS-B 7,2W/M IP54RGB	24532	5905339245328	1m = 7,2	1m = 130	RGB	54	5000
LEDS-B 7,2W/M IP65RGB	24531	5905339245311	1m = 7,2	1m = 130	RGB	65	5000



AKCESORIA ▶ ACCESSORIES

CONNECTOR RGB 10-CP	19036	5905339190369	Konektor do taśmy LED, CONNECTOR RGB 10-CP (19036) / LED band connector, CONNECTOR RGB 10-CP (19036)				
CONNECTOR RGB 10-CPC	19037	5905339190376	Konektor do taśmy LED, CONNECTOR RGB 10-CPC (19037) / LED band connector, CONNECTOR RGB 10-CPC (19037)				
CONNECTOR RGB 10	19038	5905339190383	Konektor do taśmy LED, CONNECTOR RGB 10 (19038) / LED band connector, CONNECTOR RGB 10 (19038)				
CONTROLLER RGB-IR20	18960	5905339189608	Kontroler RGB + pilot, CONTROLLER LED RGB-IR20 (18960) / Controller RGB + remote control, CONTROLLER LED RGB-IR20 (18960)				
CONTROLLER LED RGB-RF	22140	5905339221407	Kontroler RGB + pilot, CONTROLLER LED RGB-RF (22140) / Controller RGB + remote control, CONTROLLER LED RGB-RF (22140)				

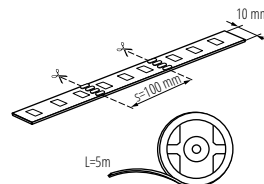

LEDS-B 7,2 W/M IP00RGB; IP54RGB; IP65RGB

Kanlux

LED STRIP L48 RGBW

TAŚMA LED ▶ LED TAPE

NEW



L48 9W/M 24



3+

WARRANTY

3 years

RGB + W

24V

3M

3M

tape

Kanlux L48 to taśma pozwalająca na swobodną zmianę koloru świecenia. Wyczarujesz dzięki niej dowolne instalacje świetlne i stworzysz wymarzoną atmosferę. Do wyboru masz dwie wersje szczelności IP00 i IP65. Wersja IP65 przeznaczona jest do miejsc gdzie narażona może być na działanie wilgoci, nie różni się ona znacznie gabarytami od wersji IP00 - ma to znaczenie przy montażu w profilach aluminiowych, który nie będzie problemem.

3 lat Gwarancji na warunkach oświadczenia gwarancyjnego, dostępnego na stronie internetowej

Do prawidłowego działania wymagany jest kontroler i pilot (CTRL 12/24V 10A RGBW 22143, REMOTE RGBW 22146), dostępne one są w ofercie KANLUX

Kanlux L48 is a tape that allows you to change the color of the light freely. You will conjure up any light installations and create your dream atmosphere. You can choose between two versions of IP00 and IP65. The IP65 version is designed for places where it can be exposed to moisture, it does not differ significantly in size from the IP00 version - this is important for installation in aluminum profiles, which will not be a problem.

3 years Warranty under the terms of the warranty statement, available on our website
Proper controller and remote (CTRL 12/24V 10A RGBW 22143, REMOTE RGBW 22146) available in Kanlux offer are required for correct operation.

L48 9W/M 24 IP00-RGBW	33318	5905339333186	1m = 9	1m = max 540	RGBW	00	5000		
L48 9W/M 24 IP65-RGBW	33319	5905339333193	1m = 9	1m = max 490	RGBW	65	5000		

[V]
24 DC

III

≥30000

SMD

30000

0,1m

5±25

CE

EAC

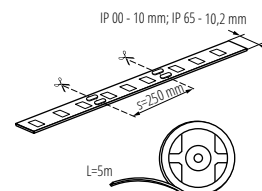

L48 9W/M 24

LEDS SET

ZESTAW LED ► LED KIT



LEDS SET W-SE BTRY



LEDS SET S-DIM IR



LEDS SET S-DIM TS



Gotowe zestawy pasków LED do samodzielnego montażu. Każdy zestaw Kanlux LEDS SET posiada samodzielne źródło zasilania (baterijne lub zasilacz), dzięki któremu możemy zamontować je w każdym miejscu. W zależności od potrzeb możemy wybrać zestaw z czujnikiem ruchu, włącznikiem zbliżeniowym lub dotykowym.

Materiał: tworzywo sztuczne

Ready sets of LED strips for self-assembly. Each Kanlux LEDS SET has an independent power source (battery or power supply) owing to which we can mount them in any place. Depending on our needs, we can choose a set with a motion detector, proximity or touch switch.

Materiał: plastic

LEDS SET S-DIM IR	26320	5905339263209	7,5	450	3000-3900	
LEDS SET S-DIM TS	26321	5905339263216	7,5	450	3000-3900	
LEDS SET W-SE BTRY	26323	5905339263230	2,4	180	3000-3900	

IP 54/20	ellipse ≤ 60 Max diam	hand ≥ 15000	sun Ra ≥ 80	triangle in circle
house	SMD	clock 15000 (h)	lightning bolt 0,1m	CE

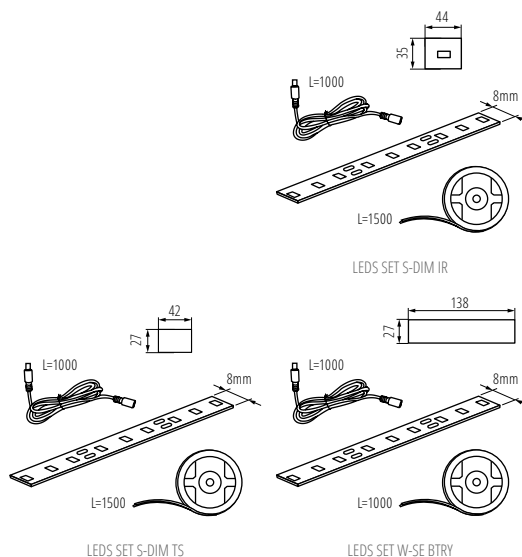

Kanlux

CONTROLLER MONO

KONTROLER DO TAŚM LED ► CONTROLLER FOR LED TAPES

NEW



CTRL 12/24V 10A MONO



REMOTE MONO



CTRL 12\24V 10A MONO	22141	5905339221414	biały white	12 DC; 24 DC	max 10	max 30
REMOTE MONO	22144	5905339221445	biały white	2 x 1,5 DC	2 x AAA	max 30

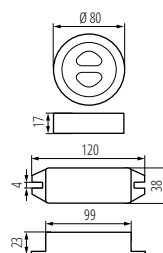
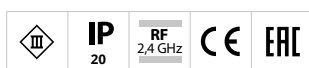

CTRL 12/24V 10A MONO; REMOTE MONO

Kanlux

CONTROLLER CCT

KONTROLER DO TAŚM LED ► CONTROLLER FOR LED TAPES

NEW



CTRL 12/24V 10A CCT



REMOTE CCT



CTRL 12\24V 10A CCT	22142	5905339221421	biały white	12 DC; 24 DC	max 10	max 30
REMOTE CCT	22145	5905339221452	biały white	2 x 1,5 DC	2 x AAA	max 30

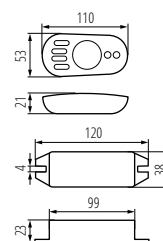

CTRL 12/24V 10A CCT; REMOTE CCT;



Kontroler współpracuje z jednokolorowymi taśmami LED Pilot 1 kanałowy

Materiał: tworzywo sztuczne

Controlers works with one color LED STRIPS 1-channel remote

Material: plastic



Kontroler współpracuje z jednokolorowymi taśmami LED oraz taśmami LED CCT Pilot 4 kanałowy

Materiał: tworzywo sztuczne

Controler works with one color and CCT LED STRIPS 4-channel remote

Material: plastic

Kanlux

CONTROLLER

KONTROLER DO TAŚM LED ► CONTROLLER FOR LED TAPES



Material: tworzywo sztuczne

Material: plastic



CONTROLLER RGB-IR20



CONTROLLER LED RGB-RF

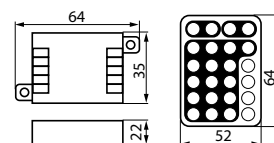

CONTROLLER RGB-IR20

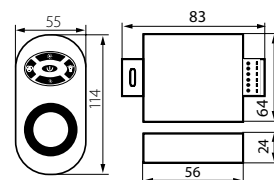

CONTROLLER LED RGB-RF



CONTROLLER RGB-IR20	18960	5905339189608	biały white	12 DC	max 6	CR2025 1X3V	max 5
CONTROLLER LED RGB-RF	22140	5905339221407	biały white	12 DC	max 15	3 x AAA	max 25



Kanlux

CONTROLLER RGBW

KONTROLER DO TAŚM LED ► CONTROLLER FOR LED TAPES

NEW



Kontroler współpracuje z jednokolorowymi taśmami LED oraz taśmami LED RGB/RGBW Pilot 4 kanałowy

Materiał: tworzywo sztuczne

Contolrer works with one color and RGB/RGBW LED STRIPS 4-channel remote

Material: plastic



CTRL 12/24V 10A RGBW



REMOTE RGBW



CTRL 12/24V 10A RGBW	22143	5905339221438	biały white	12 DC; 24 DC	max 10	max 30
REMOTE RGBW	22146	5905339221469	biały white	2 x 1,5 DC	2 x AAA	max 30



IP 20

RF 2,4 GHz



EAC

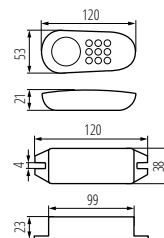

CTRL 12/24V 10A RGBW; REMOTE RGBW



Kanlux

PROFILO A

PROFIL ALUMINIOWY ► ALUMINIUM PROFILE



PROFILO A



Uniwersalny profil dekoracyjno-oświetleniowy

Materiał: stop aluminium

Multi-purpose decorative lighting profile

Material: aluminum alloy



PROFILO A | 19160 | 5905339191601 | anodowany | anodised | 1000

CE

AKCESORIA ► ACCESSORIES

SHADE A-FR	19170	5905339191700	Klosz transparentny do profilu aluminiowego, komplet 10 szt., SHADE A-FR (19170) / Transparent light cover for aluminium profile, package 10 pcs., SHADE A-FR (19170)
HANDLE A	19190	5905339191908	Uchwyt mocujący + zaślepki do profilu aluminiowego, HANDLE A (19190) / Mounting bracket + aluminium profile caps, HANDLE A (19190)

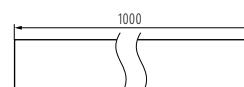
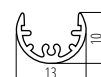

PROFILO A

PROFILO B

PROFIL ALUMINIOWY ► ALUMINIUM PROFILE



PROFILO B



Mały, nawierzchniowy uniwersalny profil dekoracyjno-oświetleniowy

Materiał: stop aluminium

Small, surface, multi-purpose decorative lighting profile

Materiał: aluminium alloy

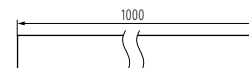

PROFILO B

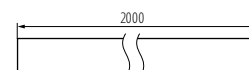

PROFILO B 2M



[mm]

PROFILO B	19161	5905339191618	anodowany anodised	1000
PROFILO B 2m	26540	5905339265401	anodowany anodised	2000



AKCESORIA ► ACCESSORIES

SHADE B/F-FR	26568	5905339265685	Klosz szroniony do profilu aluminiowego, komplet 10 szt., SHADE B/F-FR(26568) / Frosted light cover for aluminium profile, package 10 pcs., SHADE B/F-FR(26568)
SHADE B/F-FR 2M	26570	5905339265708	Klosz szroniony do profilu aluminiowego, komplet 10 szt., SHADE B/F-FR 2M(26570) / Frosted light cover for aluminium profile, package 10 pcs., SHADE B/F-FR 2M(26570)
SHADE B/F-W	26569	5905339265692	Klosz biały do profilu aluminiowego, komplet 10 szt., SHADE B/F-W(26569) / White shade for aluminium profile, package 10 pcs., SHADE B/F-W(26569)
SHADE B/F-W 2M	26571	5905339265715	Klosz biały do profilu aluminiowego, komplet 10 szt., SHADE B/F-W 2M(26571) / White shade for aluminium profile, package 10 pcs., SHADE B/F-W 2M(26571)
HANDLE B/F	26596	5905339265968	Uchwyt mocujący profil aluminiowy, HANDLE B/F (26596) / Aluminium profile mounting bracket, HANDLE B/F (26596)
CONNECT-L B	26604	5905339266040	Łącznik do profilu aluminiowego, CONNECT-L B (26604) / Aluminium profile connector, CONNECT-L B (26604)
STOPPER B	19181	5905339191816	Zasłepka do profilu aluminiowego, STOPPER B (19181) / Aluminium profile cap, STOPPER B (19181)



PROFILO C

PROFIL ALUMINIOWY ► ALUMINIUM PROFILE



PROFILO C

PROFILO C	19162	5905339191625	anodowany anodised	1000	
PROFILO C 2m	26541	5905339265418	anodowany anodised	2000	



AKCESORIA ► ACCESSORIES

SHADE C/D/E/I-FR	26572	5905339265722	Klosz szroniony do profilu aluminiowego, komplet 10 szt., SHADE C/D/E/I-FR(26572) / Frosted light cover for aluminium profile, package 10 pcs., SHADE C/D/E/I-FR(26572)
SHADE C/D/E/I-FR2M	26573	5905339265739	Klosz szroniony do profilu aluminiowego, komplet 10 szt., SHADE C/D/E/I-FR 2M(26573) / Frosted light cover for aluminium profile, package 10 pcs., SHADE C/D/E/I-FR 2M(26573)
SHADE C/D/E/I-W	26574	5905339265746	Klosz biały do profilu aluminiowego, komplet 10 szt., SHADE C/D/E/I-W(26574) / White shade for aluminium profile, package 10 pcs., SHADE C/D/E/I-W(26574)
SHADE C/D/E/I-W2M	26575	5905339265753	Klosz biały do profilu aluminiowego, komplet 10 szt., SHADE C/D/E/I-W 2M(26575) / White shade for aluminium profile, package 10 pcs., SHADE C/D/E/I-W 2M(26575)
SHADE CK C/D/E/I-FR	26576	5905339265760	Klosz transparentny do profilu aluminiowego, komplet 10 szt., SHADE CK C/D/E/I-FR(26576) / Transparent light cover for aluminium profile, package 10 pcs., SHADE CK C/D/E/I-FR(26576)
SHADE CK C/D/E/I-FR2M	26577	5905339265777	Klosz transparentny do profilu aluminiowego, komplet 10 szt., SHADE CK C/D/E/I-FR2M(26577) / Transparent light cover for aluminium profile, package 10 pcs., SHADE CK C/D/E/I-FR2M(26577)
SHADE CK C/D/E/I-W	26578	5905339265784	Klosz biały do profilu aluminiowego, komplet 10 szt., SHADE CK C/D/E/I-W(26578) / White shade for aluminium profile, package 10 pcs., SHADE CK C/D/E/I-W(26578)
SHADE CK C/D/E/I-W2M	26579	5905339265791	Klosz biały do profilu aluminiowego, komplet 10 szt., SHADE CK C/D/E/I-W 2M(26579) / White shade for aluminium profile, package 10 pcs., SHADE CK C/D/E/I-W 2M(26579)
HANDLE C/D/E/I	26597	5905339265975	Uchwyt mocujący profil aluminiowy, HANDLE C/D/E/I (26597) / Aluminium profile mounting bracket, HANDLE C/D/E/I (26597)
CONNECT C/D/E/I	26563	5905339265630	Łącznik do profilu aluminiowego, CONNECT C/D/E/I(26563) / Aluminium profile connector, CONNECT C/D/E/I(26563)
CONNECT-L C	26562	5905339265623	Łącznik do profilu aluminiowego, CONNECT-L C(26562) / Aluminium profile connector, CONNECT-L C(26562)
STOPPER C	19182	5905339191823	Zasłepka do profilu aluminiowego, STOPPER C (19182) / Aluminium profile cap, STOPPER C (19182)

slide

click

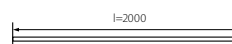

PROFILO C 2M

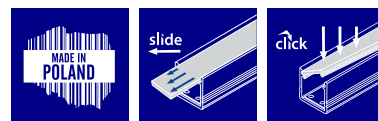

Kątowy (30° i 60°) profil dekoracyjno-oświetleniowy

Materiał: stop aluminium

Angular (30° and 60°) decorative lighting profile

Materiał: aluminium alloy

Kanlux

PROFILO D

PROFIL ALUMINIOWY ► ALUMINIUM PROFILE



PROFILO D



PROFILO D	19163	5905339191632	anodowany anodised	1000
PROFILO D 2m	26542	5905339265425	anodowany anodised	2000



AKCESORIA ► ACCESSORIES

SHADE C/D/E/I-FR	26572	5905339265722	Klosz szroniony do profilu aluminiowego, komplet 10 szt., SHADE C/D/E/I-FR(26572) / Frosted light cover for aluminium profile, package 10 pcs., SHADE C/D/E/I-FR(26572)
SHADE C/D/E/I-FR 2M	26573	5905339265739	Klosz szroniony do profilu aluminiowego, komplet 10 szt., SHADE C/D/E/I-FR 2M(26573) / Frosted light cover for aluminium profile, package 10 pcs., SHADE C/D/E/I-FR 2M(26573)
SHADE C/D/E/I-W	26574	5905339265746	Klosz biały do profilu aluminiowego, komplet 10 szt., SHADE C/D/E/I-W(26574) / White shade for aluminium profile, package 10 pcs., SHADE C/D/E/I-W(26574)
SHADE C/D/E/I-W 2M	26575	5905339265753	Klosz biały do profilu aluminiowego, komplet 10 szt., SHADE C/D/E/I-W 2M(26575) / White shade for aluminium profile, package 10 pcs., SHADE C/D/E/I-W 2M(26575)
SHADE CK C/D/E/I-FR	26576	5905339265760	Klosz transparentny do profilu aluminiowego, komplet 10 szt., SHADE CK C/D/E/I-FR(26576) / Transparent light cover for aluminium profile, package 10 pcs., SHADE CK C/D/E/I-FR(26576)
SHADE CK C/D/E/I-FR 2M	26577	5905339265777	Klosz transparentny do profilu aluminiowego, komplet 10 szt., SHADE CK C/D/E/I-FR 2M(26577) / Transparent light cover for aluminium profile, package 10 pcs., SHADE CK C/D/E/I-FR 2M(26577)
SHADE CK C/D/E/I-W	26578	5905339265784	Klosz biały do profilu aluminiowego, komplet 10 szt., SHADE CK C/D/E/I-W(26578) / White shade for aluminium profile, package 10 pcs., SHADE CK C/D/E/I-W(26578)
SHADE CK C/D/E/I-W 2M	26579	5905339265791	Klosz biały do profilu aluminiowego, komplet 10 szt., SHADE CK C/D/E/I-W 2M(26579) / White shade for aluminium profile, package 10 pcs., SHADE CK C/D/E/I-W 2M(26579)
HANDLE C/D/E/I	26597	5905339265975	Uchwyt mocujący profil aluminiowy, HANDLE C/D/E/I (26597) / Aluminium profile mounting bracket, HANDLE C/D/E/I (26597)
CONNECT C/D/E/I	26563	5905339265630	Łącznik do profilu aluminiowego, CONNECT C/D/E/I(26563) / Aluminium profile connector, CONNECT C/D/E/I(26563)
STOPPER D	19183	5905339191830	Zasłepka do profilu aluminiowego, STOPPER D (19183) / Aluminium profile cap, STOPPER D (19183)

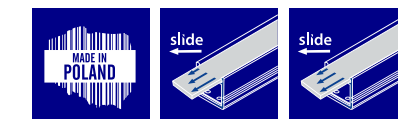

Nawierzchniowy profil dekoracyjno-oświetleniowy

Materiał: stop aluminium

Surface decorative lighting profile

Materiał: aluminium alloy

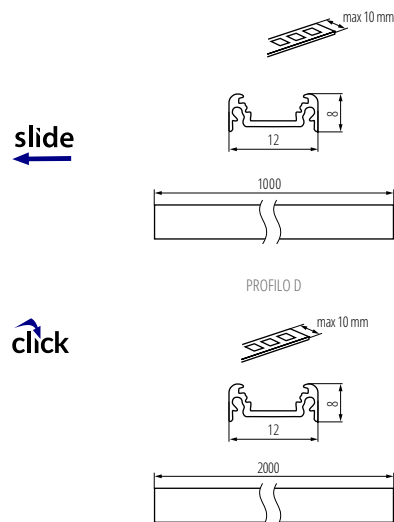

PROFILO D 2M

PROFILO E

PROFIL ALUMINIOWY ► ALUMINIUM PROFILE



PROFILO E

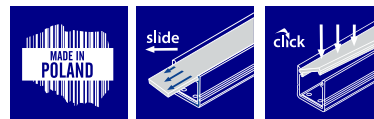

Kątowny (45°) profil dekoracyjno-oświetleniowy

Materiał: stop aluminium

Angular (45°) decorative lighting profile

Materiał: aluminium alloy



PROFILO E	19164	5905339191649	anodowany anodised	1000
PROFILO E 2m	26543	5905339265432	anodowany anodised	2000



AKCESORIA ► ACCESSORIES

SHADE C/D/E/I-FR	26572	5905339265722	Klosz szroniony do profilu aluminiowego, komplet 10 szt., SHADE C/D/E/I-FR(26572) / Frosted light cover for aluminium profile, package 10 pcs., SHADE C/D/E/I-FR(26572)
SHADE C/D/E/I-FR2M	26573	5905339265739	Klosz szroniony do profilu aluminiowego, komplet 10 szt., SHADE C/D/E/I-FR 2M(26573) / Frosted light cover for aluminium profile, package 10 pcs., SHADE C/D/E/I-FR 2M(26573)
SHADE C/D/E/I-W	26574	5905339265746	Klosz biały do profilu aluminiowego, komplet 10 szt., SHADE C/D/E/I-W(26574) / White shade for aluminium profile, package 10 pcs., SHADE C/D/E/I-W(26574)
SHADE C/D/E/I-W2M	26575	5905339265753	Klosz biały do profilu aluminiowego, komplet 10 szt., SHADE C/D/E/I-W 2M(26575) / White shade for aluminium profile, package 10 pcs., SHADE C/D/E/I-W 2M(26575)
SHADE CK C/D/E/I-FR	26576	5905339265760	Klosz transparentny do profilu aluminiowego, komplet 10 szt., SHADE CK C/D/E/I-FR(26576) / Transparent light cover for aluminium profile, package 10 pcs., SHADE CK C/D/E/I-FR(26576)
SHADE CK C/D/E/I-FR2M	26577	5905339265777	Klosz transparentny do profilu aluminiowego, komplet 10 szt., SHADE CK C/D/E/I-FR2M(26577) / Transparent light cover for aluminium profile, package 10 pcs., SHADE CK C/D/E/I-FR2M(26577)
SHADE CK C/D/E/I-W	26578	5905339265784	Klosz biały do profilu aluminiowego, komplet 10 szt., SHADE CK C/D/E/I-W(26578) / White shade for aluminium profile, package 10 pcs., SHADE CK C/D/E/I-W(26578)
SHADE CK C/D/E/I-W2M	26579	5905339265791	Klosz biały do profilu aluminiowego, komplet 10 szt., SHADE CK C/D/E/I-W 2M(26579) / White shade for aluminium profile, package 10 pcs., SHADE CK C/D/E/I-W 2M(26579)
HANDLE C/D/E/I	26597	5905339265975	Uchwyt mocujący profil aluminiowy, HANDLE C/D/E/I (26597) / Aluminium profile mounting bracket, HANDLE C/D/E/I (26597)
CONNECT C/D/E/I	26563	5905339265630	Łącznik do profilu aluminiowego, CONNECT C/D/E/I(26563) / Aluminium profile connector, CONNECT C/D/E/I(26563)
STOPPER E	19184	5905339191847	Zasłepka do profilu aluminiowego, STOPPER E (19184) / Aluminium profile cap, STOPPER E (19184)

slide

click

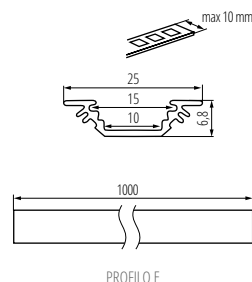

PROFILO E

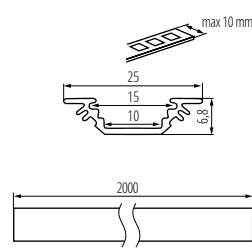

PROFILO E 2M

Kanlux

PROFILO F

PROFIL ALUMINIOWY ► ALUMINIUM PROFILE



PROFILO F

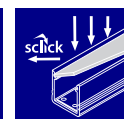

Uniwersalny profil dekoracyjno-oświetleniowy

Materiał: stop aluminium

Multi-purpose decorative lighting profile

Materiał: aluminium alloy

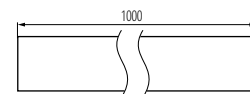
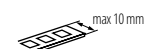

PROFILO F

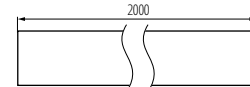
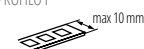

PROFILO F 2M



PROFILO F	26552	5905339265524	anodowany anodised	1000
PROFILO F 2m	26553	5905339265531	anodowany anodised	2000



AKCESORIA ► ACCESSORIES

SHADE B/F-FR	26568	5905339265685	Klosz szroniony do profilu aluminiowego, komplet 10 szt., SHADE B/F-FR(26568) / Frosted light cover for aluminium profile, package 10 pcs., SHADE B/F-FR(26568)
SHADE B/F-FR 2M	26570	5905339265708	Klosz szroniony do profilu aluminiowego, komplet 10 szt., SHADE B/F-FR 2M(26570) / Frosted light cover for aluminium profile, package 10 pcs., SHADE B/F-FR 2M(26570)
SHADE B/F-W	26569	5905339265692	Klosz biały do profilu aluminiowego, komplet 10 szt., SHADE B/F-W(26569) / White shade for aluminium profile, package 10 pcs., SHADE B/F-W(26569)
SHADE B/F-W 2M	26571	5905339265715	Klosz biały do profilu aluminiowego, komplet 10 szt., SHADE B/F-W 2M(26571) / White shade for aluminium profile, package 10 pcs., SHADE B/F-W 2M(26571)
HANDLE B/F	26596	5905339265968	Uchwyt mocujący profil aluminiowy, HANDLE B/F (26596) / Aluminium profile mounting bracket, HANDLE B/F (26596)
STOPPER F	26590	5905339265906	Zaślepki do profilu aluminiowego, STOPPER F (26590) / Aluminium profile caps, STOPPER F (26590)



PROFILO G

PROFIL ALUMINIOWY ► ALUMINIUM PROFILE



PROFILO G

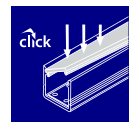

Wpustowy profil dekoracyjno-oświetleniowy do podłóg

Materiał: stop aluminium

Recessed decorative lighting profile

Materiał: aluminium alloy



PROFILO G	26558	5905339265586	anodowany anodised	1000
PROFILO G 2m	26559	5905339265593	anodowany anodised	2000



AKCESORIA ► ACCESSORIES

SHADE CK G	26580	5905339265807	Klosz biały do profilu aluminiowego, komplet 10 szt., SHADE CK G(26580) / White shade for aluminium profile, package 10 pcs., SHADE CK G(26580)
SHADE CK G 2M	26581	5905339265814	Klosz biały do profilu aluminiowego, komplet 5 szt., SHADE CK G 2M(26581) / White shade for aluminium profile, package 5 pcs., SHADE CK G 2M(26581)
HANDLE G	26598	5905339265982	Uchwyt mocujący profil aluminiowy, HANDLE G (26598) / Aluminium profile mounting bracket, HANDLE G (26598)
STOPPER G	26592	5905339265920	Zasłepki do profilu aluminiowego, STOPPER G (26592) / Aluminium profile caps, STOPPER G (26592)
SEALINGS G	26602	5905339266026	Uszczelka do profilu aluminiowego, SEALINGS G (26602) / Aluminium profile gasket, SEALINGS G (26602)

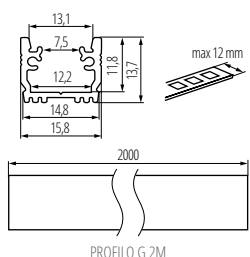
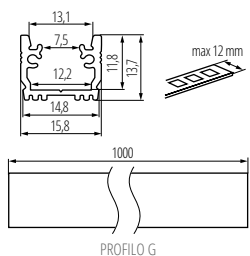

PROFILO H

PROFIL ALUMINIOWY ► ALUMINIUM PROFILE

PROFILO H

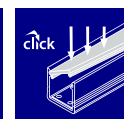

Profil dekoracyjno-oświetleniowy do zastosowań giętych w dwóch kierunkach jednej płaszczyzny

Materiał: stop aluminium

Flexible decorative lighting profile - possibilities of bending in two directions

Materiał: aluminium alloy

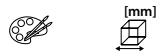

PROFILO H	26560	5905339265609	anodowany anodised	1000
PROFILO H 2m	26561	5905339265616	anodowany anodised	2000



AKCESORIA ► ACCESSORIES

SHADE-O H-W	26586	5905339265869	Klosz biały do profilu aluminiowego, komplet 10 szt., SHADE-O H-W(26586) / White shade for aluminium profile, package 10 pcs., SHADE-O H-W(26586)
SHADE-O H-W 2m	26587	5905339265876	Klosz biały do profilu aluminiowego, komplet 5 szt., SHADE-O H-W 2m(26587) / White shade for aluminium profile, package 5 pcs., SHADE-O H-W 2m(26587)
SHADE-U H-FR	26582	5905339265821	Klosz transparentny do profilu aluminiowego, komplet 10 szt., SHADE-U H-FR(26582) / Transparent light cover for aluminium profile, package 10 pcs., SHADE-U H-FR(26582)
SHADE-U H-FR 2m	26583	5905339265838	Klosz transparentny do profilu aluminiowego, komplet 5 szt., SHADE-U H-FR 2m(26583) / Transparent light cover for aluminium profile, package 5 pcs., SHADE-U H-FR 2m(26583)
SHADE-U H-W	26584	5905339265845	Klosz do profilu aluminiowego, komplet 10 szt., SHADE-U H-W(26584) / Shade for aluminium profile, package 10 pcs., SHADE-U H-W(26584)
SHADE-U H-W 2m	26585	5905339265852	Klosz biały do profilu aluminiowego, komplet 5 szt., SHADE-U H-W 2m(26585) / White shade for aluminium profile, package 5 pcs., SHADE-U H-W 2m(26585)
HANDLE H	26599	5905339265999	Uchwyt mocujący profil aluminiowy, HANDLE H (26599) / Aluminium profile mounting bracket, HANDLE H (26599)
HANDLE SIDE H	26600	5905339266002	Uchwyt mocujący profil aluminiowy, HANDLE SIDE H (26600) / Aluminium profile mounting bracket, HANDLE SIDE H (26600)
STOPPER-U H	26593	5905339265937	Zasłepki do profilu aluminiowego, STOPPER-U H (26593) / Aluminium profile caps, STOPPER-U H (26593)
STOPPER-O H	26594	5905339265944	Zasłepki do profilu aluminiowego, STOPPER-O H (26594) / Aluminium profile caps, STOPPER-O H (26594)

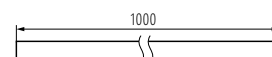
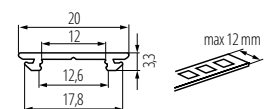

PROFILO H

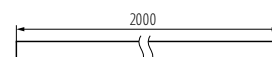
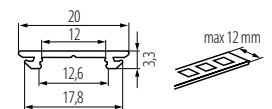

PROFILO H 2M

PROFILO I

PROFIL ALUMINIOWY ► ALUMINIUM PROFILE



PROFILO I



PROFILO I-W

					[mm]
PROFILO I	26554	5905339265548	anodowany anodised		1000
PROFILO I 2m	26555	5905339265555	anodowany anodised		2000
PROFILO I-W	26556	5905339265562	biały white		1000
PROFILO I-W 2m	26557	5905339265579	biały white		2000



AKCESORIA ► ACCESSORIES

SHADE C/D/E/I-FR	26572	5905339265722	Klosz szroniony do profilu aluminiowego, komplet 10 szt., SHADE C/D/E/I-FR(26572) / Frosted light cover for aluminium profile, package 10 pcs., SHADE C/D/E/I-FR(26572)
SHADE C/D/E/I-FR 2M	26573	5905339265739	Klosz szroniony do profilu aluminiowego, komplet 10 szt., SHADE C/D/E/I-FR 2M(26573) / Frosted light cover for aluminium profile, package 10 pcs., SHADE C/D/E/I-FR 2M(26573)
SHADE C/D/E/I-W	26574	5905339265746	Klosz biały do profilu aluminiowego, komplet 10 szt., SHADE C/D/E/I-W(26574) / White shade for aluminium profile, package 10 pcs., SHADE C/D/E/I-W(26574)
SHADE C/D/E/I-W 2M	26575	5905339265753	Klosz biały do profilu aluminiowego, komplet 10 szt., SHADE C/D/E/I-W 2M(26575) / White shade for aluminium profile, package 10 pcs., SHADE C/D/E/I-W 2M(26575)
SHADE CK C/D/E/I-FR	26576	5905339265760	Klosz transparentny do profilu aluminiowego, komplet 10 szt., SHADE CK C/D/E/I-FR(26576) / Transparent light cover for aluminium profile, package 10 pcs., SHADE CK C/D/E/I-FR(26576)
SHADE CK C/D/E/I-FR 2M	26577	5905339265777	Klosz transparentny do profilu aluminiowego, komplet 10 szt., SHADE CK C/D/E/I-FR 2M(26577) / Transparent light cover for aluminium profile, package 10 pcs., SHADE CK C/D/E/I-FR 2M(26577)
SHADE CK C/D/E/I-W	26578	5905339265784	Klosz biały do profilu aluminiowego, komplet 10 szt., SHADE CK C/D/E/I-W(26578) / White shade for aluminium profile, package 10 pcs., SHADE CK C/D/E/I-W(26578)
SHADE CK C/D/E/I-W 2M	26579	5905339265791	Klosz biały do profilu aluminiowego, komplet 10 szt., SHADE CK C/D/E/I-W 2M(26579) / White shade for aluminium profile, package 10 pcs., SHADE CK C/D/E/I-W 2M(26579)
HANDLE C/D/E/I	26597	5905339265975	Uchwyt mocujący profil aluminiowy, HANDLE C/D/E/I (26597) / Aluminium profile mounting bracket, HANDLE C/D/E/I (26597)
CONNECT C/D/E/I	26563	5905339265630	Łącznik do profilu aluminiowego, CONNECT C/D/E/I(26563) / Aluminium profile connector, CONNECT C/D/E/I(26563)
SPRING I	26601	5905339266019	Uchwyt sprężynowy do profilu aluminiowego, SPRING I (26601) / Spring-loaded bracket for aluminium profile, SPRING I (26601)
STOPPER I	26591	5905339265913	Zasłepki do profilu aluminiowego, STOPPER I (26591) / Aluminium profile caps, STOPPER I (26591)
STOPPER I-W	26603	5905339266033	Zasłepki do profilu aluminiowego, STOPPER I-W (26603) / Aluminium profile caps, STOPPER I-W (26603)

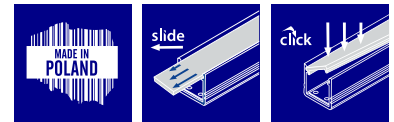

Wpustowy profil dekoracyjno-oświetleniowy

Materiał: stop aluminium

Recessed decorative lighting profile

Material: aluminum alloy



slide

click

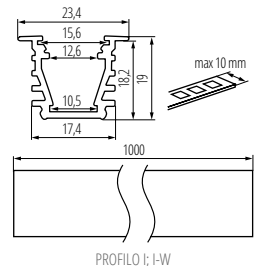

PROFILO I; I-W

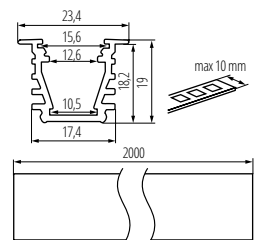

PROFILO I; I-W 2M



PROFILO J

PROFIL ALUMINIOWY ► ALUMINIUM PROFILE



PROFILO J



PROFILO J-W

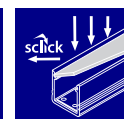

Nawierzchniowy profil dekoracyjno-oświetleniowy

Materiał: stop aluminium

Surface decorative lighting profile

Materiał: aluminium alloy



PROFILO J	26544	5905339265449	anodowany anodised	1000
PROFILO J 2M	26545	5905339265456	anodowany anodised	2000
PROFILO J-W	26546	5905339265463	biały white	1000
PROFILO J-W 2M	26547	5905339265470	biały white	2000



AKCESORIA ► ACCESSORIES

SHADE J/K-FR	26564	5905339265647	Klosz szroniony do profilu aluminiowego, komplet 10 szt., SHADE J/K-FR(26564) / Frosted light cover for aluminium profile, package 10 pcs., SHADE J/K-FR(26564)
SHADE J/K-FR 2m	26566	5905339265661	Klosz szroniony do profilu aluminiowego, komplet 10 szt., SHADE J/K-FR 2m(26566) / Frosted light cover for aluminium profile, package 10 pcs., SHADE J/K-FR 2m(26566)
SHADE J/K-W	26565	5905339265654	Klosz biały do profilu aluminiowego, komplet 10 szt., SHADE J/K-W(26565) / White shade for aluminium profile, package 10 pcs., SHADE J/K-W(26565)
SHADE J/K-W 2m	26567	5905339265678	Klosz biały do profilu aluminiowego, komplet 10 szt., SHADE J/K-W 2m(26567) / White shade for aluminium profile, package 10 pcs., SHADE J/K-W 2m(26567)
HANDLE J/K	26595	5905339265951	Uchwyt mocujący profil aluminiowy, HANDLE J/K (26595) / Aluminium profile mounting bracket, HANDLE J/K (26595)
STOPPER J	26588	5905339265883	Zasłepki do profilu aluminiowego, STOPPER J (26588) / Aluminium profile caps, STOPPER J (26588)
STOPPER J-W	26605	5905339266057	Zasłepki do profilu aluminiowego, STOPPER J-W (26605) / Aluminium profile caps, STOPPER J-W (26605)

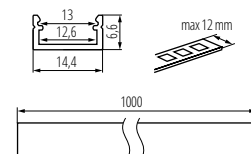

PROFILO J; J-W

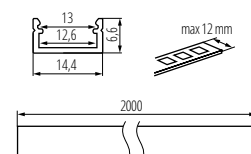

PROFILO J; J-W 2M

PROFILO K

PROFIL ALUMINIOWY ► ALUMINIUM PROFILE



PROFILO K



PROFILO K-W

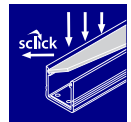

Wpustowy profil dekoracyjno-oświetleniowy

Materiał: stop aluminium

Recessed decorative lighting profile

Material: aluminum alloy



PROFILO K	26548	5905339265487	anodowany anodised	1000
PROFILO K 2m	26549	5905339265494	anodowany anodised	2000
PROFILO K-W	26550	5905339265500	biały white	1000
PROFILO K-W 2m	26551	5905339265517	biały white	2000



AKCESORIA ► ACCESSORIES

SHADE J/K-FR	26564	5905339265647	Klosz szroniony do profilu aluminiowego, komplet 10 szt., SHADE J/K-FR(26564) / Frosted light cover for aluminium profile, package 10 pcs., SHADE J/K-FR(26564)
SHADE J/K-FR 2m	26566	5905339265661	Klosz szroniony do profilu aluminiowego, komplet 10 szt., SHADE J/K-FR 2m(26566) / Frosted light cover for aluminium profile, package 10 pcs., SHADE J/K-FR 2m(26566)
SHADE J/K-W	26565	5905339265654	Klosz biały do profilu aluminiowego, komplet 10 szt., SHADE J/K-W(26565) / White shade for aluminium profile, package 10 pcs., SHADE J/K-W(26565)
SHADE J/K-W 2m	26567	5905339265678	Klosz biały do profilu aluminiowego, komplet 10 szt., SHADE J/K-W 2m(26567) / White shade for aluminium profile, package 10 pcs., SHADE J/K-W 2m(26567)
HANDLE J/K	26595	5905339265951	Uchwyt mocujący profil aluminiowy, HANDLE J/K (26595) / Aluminium profile mounting bracket, HANDLE J/K (26595)
STOPPER K	26589	5905339265890	Zasłepki do profilu aluminiowego, STOPPER K (26589) / Aluminium profile caps, STOPPER K (26589)
STOPPER K-W	26606	5905339266064	Zasłepki do profilu aluminiowego, STOPPER K-W (26606) / Aluminium profile caps, STOPPER K-W (26606)

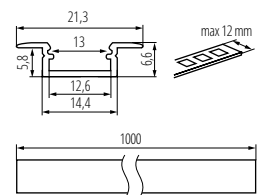

PROFILO K; K-W

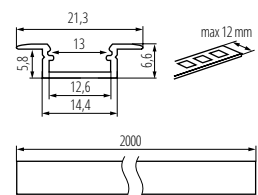

PROFILO K; K-W 2M

GIVRO LED

WAŻ ŚWIETLNY ► ROPE LIGHTS



GIVRO LED-CW 50M; CW; WW



GIVRO LED-GN 50M



GIVRO LED-BL 50M



GIVRO LED-RE 50M



GIVRO LED-CW 50M	08630	5905339086303	125	chłodnobiała cold white
GIVRO LED-BL 50M	08631	5905339086310	125	niebieska blue
GIVRO LED-RE 50M	08632	5905339086327	125	czerwona red
GIVRO LED-GN 50M	08633	5905339086334	125	zielona green
GIVRO LED-Y 50M	08634	5905339086341	125	żółta yellow
GIVRO LED-WW 50M	08642	5905339086426	125	ciepłobiała Warm white

Kanlux GIVRO LED to 50 metrowe węże świetlne dostępne w różnych barwach. Do jego prawidłowego działania wymagane jest urządzenie zasilające Kanlux GIVRO PR SET. Waż można dzielić na segmenty, a w miejscu odcięcia możliwe jest ponowne połączenie w dowolny układ dzięki elementom systemu Kanlux GIVRO LED. Za pomocą kolorowych węży LED możliwe jest wydobycie charakteru pomieszczenia. Kanlux GIVRO LED można zastosować również na zewnątrz budynków: balkonach, altankach i ogrodach.

waż o długości 50m

możliwość dzielenia pasków LED na segmenty (1m = 36 x LED)

do prawidłowego działania wymagane jest urządzenie zasilające GIVRO PR SET dostępne w ofercie Kanlux

Kanlux GIVRO LED are 50-meter rope lights available in different colours. Power supply device Kanlux GIVRO PR SET is required for its proper functioning. The rope can be divided into segments and it is possible to reconnect it at the cut-off point into any arrangement owing to the elements of Kanlux GIVRO LED system. With colourful LED ropes, it is possible to bring out the room's character. Kanlux GIVRO LED can also be used outdoors: in balconies, gazebos and gardens.

50m long rope

the possibility to divide the LED strips into segments (1m = 36 x LED)
power cord of GIVRO PR SET, available in Kanlux offer, is needed for proper operation

[V] 220-240 DC	[IP] 44	[Icon: Plug]
[Icon: Light Bulb]	[Icon: Snowflake]	[Icon: Sun]
50000	-5+25	0,1 m



AKCESORIA ► ACCESSORIES

GIVRO PR SET	08637	5905339086372	Przewód+ zestaw łączników, GIVRO PR SET(8637) / Conductor + set of connectors, GIVRO PR SET(8637)
GIVRO-90L	08636	5905339086365	Łącznik kolankowy, GIVRO-90L(8636) / Elbow connector, GIVRO-90L(8636)
GIVRO-I	08639	5905339086396	Łącznik typu „I”, GIVRO-I(8639) / Connector, type „I”, GIVRO-I(8639)
GIVRO-T	08641	5905339086419	Łącznik typu „T”, GIVRO-T (8641) / Connector, type „T”, GIVRO-T (8641)
GIVRO-X	08635	5905339086358	Łącznik typu „X”, GIVRO-X(8635) / Connector, type „X”, GIVRO-X(8635)
GIVRO-PEND	08640	5905339086402	Plastikowa zawieszka, komplet 10szt., GIVRO-PEND (8640) / Plastic tag, package 10pcs., GIVRO-PEND (8640)
GIVRO-Z	08638	5905339086389	Zasłepka, komplet 3 szt., GIVRO-Z(8638) / Stopper, package 3 pcs., GIVRO-Z(8638)

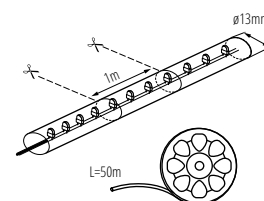

GIVRO LED 50M

Kanlux

G9 STAR

HALOGENOWE ŹRÓDŁO ŚWIATŁA ► HALIDE LIGHT SOURCE



G9-20W; 33W; 48W; 60W STAR



Kanlux G9 STAR to żarówka halogenowa z trzonkiem G9.

Materiał: stop metali niekorodujących
Materiał klosza: szkło

Kanlux G9 STAR is a halogen bulb with G9 light bulb base.

Material: non-corrosive metals alloy
Lampshade material: glass

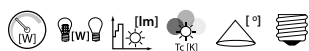

	[W]	[Hz]	[h]	[lm]	[K, IK]	[°]	[lm]
G9-20W STAR	18420	5905339184207	20	26	235	2700	360
G9-33W STAR	18421	5905339184214	33	43	460	2700	360
G9-48W STAR	18422	5905339184221	48	63	740	2700	360
G9-60W STAR	18423	5905339184238	60	78	975	2700	360

[V]	[Hz]	[h]	[lm]	[Hg]	[Ra]	[C]	CE	ERC
220-240 AC	50	2000	≥8000		≥95	C		

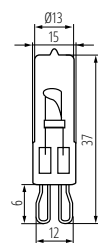

G9-20W; 33W; 48W; 60W STAR



Kanlux JC to halogenowa źródła światła z trzonkiem G4 i GY6.35.

Materiał klosza: szkło

Kanlux JC is a halogen light source with G4 and GY6.35 light bulb base.

Lampshade material: glass

JC-5W G4; 10W G4; 10W4/EK BASIC; 20W G4; 20W4/EK BASIC; 35W G4; 35W4/EK BASIC;



JC-5W G4; 10W G4; 10W4/EK BASIC; 20W G4; 20W4/EK BASIC; 35W G4; 35W4/EK BASIC;



JC-20W GY6.35; 35W GY6.35; 50W GY6.35



Model	Code	Power (W)	Beam Angle (°)	Life (h)	Temp. (K)	Base	Dim.
JC-5W G4	10720	5	60	2700	G4	B	
JC-10W4/EK BASIC	10432	10	96	2700	G4	C	
JC-10W G4	10722	10	120	2700	G4	C	
JC-20W4/EK BASIC	10433	20	280	2700	G4	C	
JC-20W G4	10724	20	330	2700	G4	C	
JC-35W4/EK BASIC	10434	35	540	2700	G4	C	
JC-20W GY6,35	10730	20	330	2700	GY6,35	C	
JC-35W GY6,35	10732	35	600	2700	GY6,35	C	
JC-50W GY6,35	10734	50	950	2700	GY6,35	C	

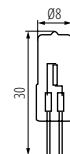

JC-5W G4; 10W G4; 10W4/EK BASIC; 20W G4; 20W4/EK BASIC; 35W G4; 35W4/EK BASIC;

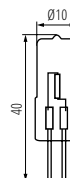

JC-20W GY6.35; 35W GY6.35; 50W GY6.35





J-1000W 189MM

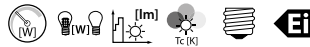

J-1000W 189MM	10418	5905339104182	1000	1063	16000	2700	R7s	D
J-1500W 254MM	10419	5905339104199	1500	2060	31000	2700	R7s	C

[V]	[Hz]	[h]	[lm]	[K]	CE	EAC
220-240 AC	50	2000	≥8000			

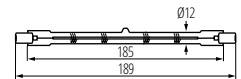

J-1000W 189MM

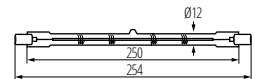

J-1500W 254MM

Kanlux J STAR



J-80W 78MM STAR

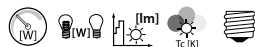

J-80W 78MM STAR	08490	5905339084903	80	100	1380	2700	R7s
J-120W 78MM STAR	08491	5905339084910	120	150	2220	2700	R7s
J-120W 118MM STAR	08500	5905339085009	120	150	2220	2700	R7s
J-160W 118MM STAR	08501	5905339085016	160	200	3100	2700	R7s
J-230W 118MM STAR	08502	5905339085023	230	300	4650	2700	R7s
J-400W 118MM STAR	08503	5905339085030	400	500	8550	2700	R7s

[V]	[Hz]	[h]	[lm]	[K]	CE	EAC
220-240 AC	50	2000	≥8000			

Projektowe żarówki halogenowe, przeznaczone są do lamp i halopaków na gwint R7s. Dostępne moce to od 1000W aż do 1500W. Przeznaczone są do pracy w poziomie.

przeznaczone do pracy w poziomie, dopuszczalny odchył pozycji pracy +/-4°
Materiał klosza: szkło

The designed halogen bulbs are intended for lamps and halopaks with R7s thread. Available power from 1000W to 1500W. They are meant for horizontal work.

designed for horizontal operation, allowable deflection of working position +/-4°
Lampshade material: glass

Projektowe żarówki halogenowe, przeznaczone są do lamp i halopaków na gwint R7s. Dostępne moce to od 80W aż do 400W. Przeznaczone są do pracy w poziomie.

strumień świetlny większy średnio o 23%, przy zużyciu prądu mniejszym o 20% (w porównaniu z halogenem w klasie F)

przeznaczone do pracy w poziomie, dopuszczalny odchył pozycji pracy +/-4°
Materiał klosza: szkło

The designed halogen bulbs are intended for lamps and halopaks with R7s thread. Available power from 80W to 400W. They are meant for horizontal work.

23% more light flux by 20% lower power consumption (compared to F class halogen)
designed for horizontal operation, allowable deflection of working position +/-4°
Lampshade material: glass

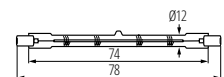

J-80W; 120W 78MM STAR

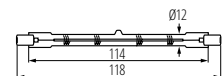

J-120W; 160W; 230W; 400W 118MM STAR

Kanlux T2U

NIEZINTEGROWANA ŚWIETŁÓWKA KOMPAKTOWA
► NON-INTEGRATED COMPACT FLUORESCENT TUBE



T2U-18W/K



T2U-26W/K



T2U-18W/K	10661	5905339106612	18	1200	4000	G24d	B	8000
T2U-26W/K	10662	5905339106629	26	1716	4000	G24d	B	8000

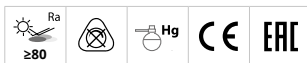

Kanlux T2U to niezintegrowane świetłówki kompaktowe o wysokiej trwałości (8000 h). Ich wysokie strumienie świetlne przy niskim poborze mocy czynią z nich energooszczędne rozwiązanie oświetleniowe dla opraw z trzonkiem G24q.

Materiał: szkło

Kanlux T2U are non-integrated compact fluorescent lamps with high durability (8000 h). Their high light streams with low consumption of power make them an energy-saving lighting solution for holders with G24q light bulb base.

Material: glass

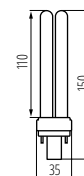

T2U-18W/K

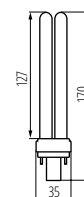

T2U-26W/K

Kanlux T1U

NIEZINTEGROWANA ŚWIETŁÓWKA KOMPAKTOWA
► NON-INTEGRATED COMPACT FLUORESCENT TUBE



T1U-9W/K, T1U-11W/K

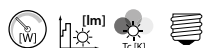

T1U-9W/K	10671	5905339106711	9	603	4000	G23		
T1U-11W/K	10672	5905339106728	11	902	4000	G23		

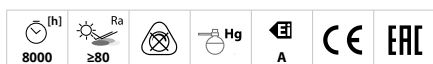

Kanlux T1U to niezintegrowane świetłówki kompaktowe o wysokiej trwałości (8000 h). Ich wysokie strumienie świetlne przy niskim poborze mocy czynią z nich energooszczędne rozwiązanie oświetleniowe dla opraw z trzonkiem G23.

Materiał: szkło

Kanlux T1U are non-integrated compact fluorescent lamps with high durability (8000 h). Their high light streams with low consumption of power make them an energy-saving lighting solution for holders with G23 light bulb base.

Material: glass

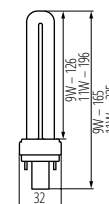

T1U-9W/K; T1U-11W/K



DD 16W/4P; 21W/4P



DD 16W/4P; 21W/4P



DD 28W/4P; 38W/4P



Kanlux DD to rodzina świetlówek kompaktowych na trzonku GR10q. Ich wysokie strumienie świetlne przy niskim poborze mocy czynią z nich energooszczędne rozwiązanie oświetleniowe dla opraw z tego typu trzonkiem.

Materiał: szkło

Kanlux DD is a family of compact fluorescent lamps with GR10q light bulb base. Their high light streams with low consumption of power make them an energy-saving lighting solution for holders with this type of the light bulb base.

Materiał: glass

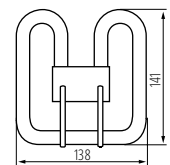

DD 16W/4P; 21W/4P

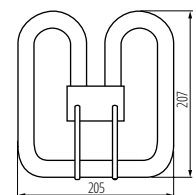

DD 28W/4P; 38W/4P

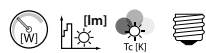

Model	Power (W)	Part No.	Length (mm)	Height (mm)	Life (h)	Beam Angle	Base
DD-16W/4P 3500K	12660	5905339126603	16	1056	3500	GR10q	
DD-21W/4P 3500K	12661	5905339126610	21	1344	3500	GR10q	
DD-28W/4P 3500K	12662	5905339126627	28	2044	3500	GR10q	
DD-38W/4P 3500K	12663	5905339126634	38	2698	3500	GR10q	

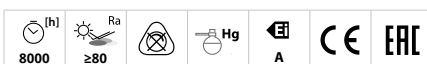

Kanlux

T5

ŚWIETŁÓWKA LINIOWA ► LINEAR FLUORESCENT LAMP

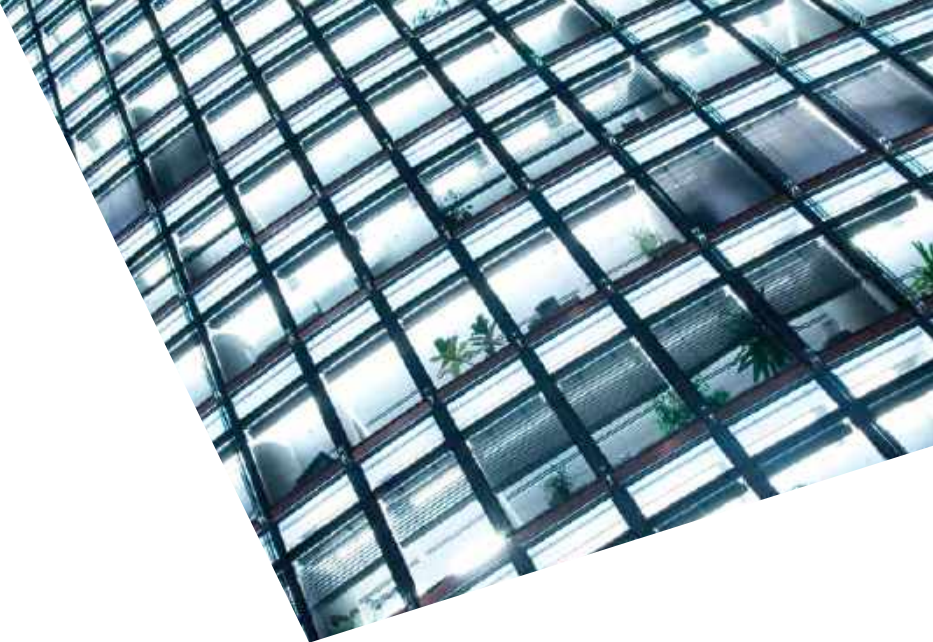

T5-8W; 13W; 14W



Kanlux T5 to jedno i trójpasemowe świetłóWki liniowe. Niskie zużycie energii i długi czas pracy (10.000H) to niewątpliwe zalety tych lamp.

T5-8W, T5-13W: świetłóWki jednopasmowe, pozostałe modele to świetłóWki trójpasemowe
Materiał: szkło

Kanlux T5 are oneband and tri-band linear fluorescent lamps. Low consumption of energy and long working time (10.000H) are indisputable advantages of these lamps.

T5-8W, T5-13W: fluorescent lamps, other models are tri-band fluorescent
Material: glass



Model	Code	Part No.	W	lm	Tc (K)	Base	Ra	Life (h)
T5-8W 4000K/65	12715	5905339127150	8	688	4000	G5	≥65	10000
T5-13W 4000K/65	12716	5905339127167	13	1118	4000	G5	≥65	10000
T5-14W 4000K/82	12717	5905339127174	14	1204	4000	G5	≥82	20000

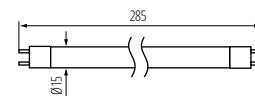

T5-8W 4000K/65

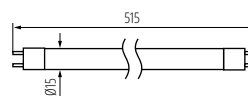

T5-13W 4000K/65

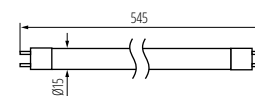

T5-14W 4000K/82





T8 18W; 36W; 58W



Kanlux T8 to trójpasemowe świetłóWki liniowe. Niskie zużycie energii i długi czas pracy (15.000H) to niewątpliwe zalety tych lamp.

Material: szkło

Kanlux T8 are triband linear fluorescent lamps. Low consumption of energy and long working time (15.000H) are indisputable advantages of these lamps.

Material: glass



T8 18W/840 NW	19921	5905339199218	18	1350	4000	G13	A
T8 18W/865 CW	19922	5905339199225	18	1250	6500	G13	A
T8 36W/840 NW	19924	5905339199249	36	3350	4000	G13	A+
T8 36W/865 CW	19925	5905339199256	36	3050	6500	G13	A
T8 58W/840 NW	19927	5905339199270	58	5250	4000	G13	A+
T8 58W/865 CW	19928	5905339199287	58	5000	6500	G13	A

[h] 15000	Ra ≥80				
--------------	-----------	--	--	--	--

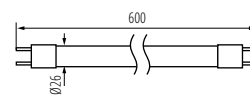

T8 18W

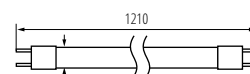

T8 36W

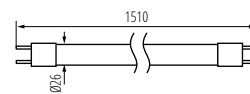

T8 58W

Kanlux

MHE

LAMPA METALOHALOGENKOWA ► METAL-HALIDE LAMP



MHE-250W/4200K

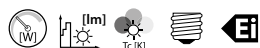

MHE-250W/4200K	12755	5905339127556	250	23000	4200	E40	A
MHE-400W/4200K	12756	5905339127563	400	35000	4200	E40	A+



Lampy metalohalogenkowe Kanlux MHE pracują ze statecznikami do wysokoprężnych lamp sodowych/lamp metalohalogenkowych i zapłonnikami do lamp metalohalogenkowych.

Material: szkło

Kanlux MHE metal-halide lamps work with stabilizers for high-pressure sodium lamps/metal-halide lamps and igniters for metal-halide lamps.

Material: glass

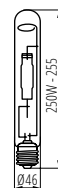

MHE-250W/4200K

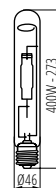

MHE-400W/4200K



Kanlux



OPRAWY DOMOWE I DEKORACYJNE
DOMESTIC AND DECORATIVE FIXTURES

**Każdego dnia gościemy w Twoim domu.
Ty dbasz o to by Twoje wnętrza były piękne,
a my dbamy o to by nasze produkty
były dopracowane w każdym detalu.**

We are present in your house every day.
You take care of the beauty of your interiors,
and we take care of refining our products
down to in the finest detail.



*dane fotometryczne znajdziesz na:
photometric data you can find on:*

► kanlux.com

Kanlux ETISSA

LAMPA WISZĄCA ► PENDANT LAMP



ETISSA D20 GR



ETISSA D20 GR | 27000 | 5905339270009 | max 40 | szary | grey



Kanlux ETISSA to lampy wiszące, które współpracują ze wszystkimi źródłami światła o trzonku E27. Oprawy wykonane są z masy betonopodobnej. Stylistycznie są to produkty utrzymane w surowym, loftowym klimacie, doskonale pasujące do nowoczesnych, minimalistycznych wnętrz. Ich powłoka jest porowata, co jest charakterystyczne dla powierzchni betonowych.

Materiał klosza: odlew gipsowy

Kanlux ETISSA are hanging lamps which cooperate with all sources of light with E27 light bulb base. Holders are made of concrete mass. In stylistic terms, they are products in a severe, loft-like climate, perfectly matching modern, minimalist interiors. Their coating is porous, which is characteristic of concrete surfaces.

Lampshade material: plaster cast

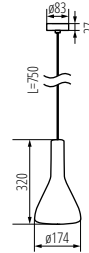

ETISSA D20 GR

Kanlux OGIVA

LAMPA WISZĄCA ► PENDANT LAMP



OGIVA D35 GR



OGIVA D35 GR | 27001 | 5905339270016 | max 40 | szary | grey



Kanlux OGIVA to lampy wiszące, które współpracują ze wszystkimi źródłami światła o trzonku E27. Oprawy wykonane są z masy betonopodobnej w kolorze naturalnym (szarym). Stylistycznie są to produkty utrzymane w surowym, loftowym stylu, doskonale pasujące do nowoczesnych, minimalistycznych wnętrz. Ich powłoka jest porowata, co jest charakterystyczne dla powierzchni betonowych. Lampy wyprodukowane zostały w Polsce.

Materiał klosza: odlew gipsowy

Kanlux OGIVA are hanging lamps co-operating with all light sources with E27 light bulb base. Luminaires are made of concrete mass of natural colour (grey). In terms of style, the products have austere, loft style, perfectly matching modern, minimalist interiors. Their coating is porous, which is characteristic of concrete surfaces. The lamps are manufactured in Poland.

Lampshade material: plaster cast

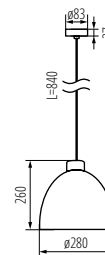

OGIVA D35 GR

Kanlux ALGO

LAMPA WISZĄCA ► PENDANT LAMP



ALGO GU10 PL-B



ALGO GU10 PO-B



Kanlux ALGO to seria opraw wiszących, które mają kształt walca lub sześcianu. Pomimo swoich niewielkich rozmiarów efektywnie prezentują się we wnętrzach domowych, czy użyteczności publicznej. Dzięki regulowanemu sznurkowi o długości do 65 cm możemy dopasować lampy Kanlux ALGO do wysokości pomieszczenia. Sami dobierzemy do oprawy pasujące nam, wymienne źródło światła (trzonek GU10).

Materiał obudowy: stop aluminium

Kanlux ALGO is a series of hanging holders in the shape of a cylinder or cube. Despite their small dimensions, they look effective in home interiors or public interiors. Thanks to the adjustable rope up to 65 cm long, you can adapt the Kanlux ALGO lamps to height of a room. You can choose the replaceable light source (GU10 light bulb base) suiting you to the holder on your own.

Enclosure material: aluminum alloy

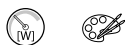

ALGO GU10 PL-B	27036	5905339270368	max 40	czarny black
ALGO GU10 PO-B	27039	5905339270399	max 40	czarny black

[V] 220-240 AC	[Hz] 50/60	PAR16	GU10	IP 20	5+25
100x100	0,75+2,5	0,5m	CE	ERC	Kanlux

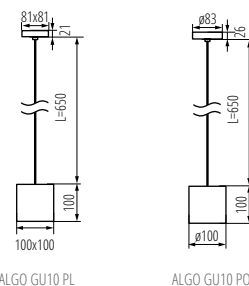

ALGO GU10 PL

ALGO GU10 PO

Kanlux

STOBI ES



OPRAWA SUFITOWA PUNKTOWA ▶ CEILING-MOUNTED SPOTLIGHT FITTING

NEW



STOBI ES 50-B



STOBI ES 50-W



STOBI ES 250-B



STOBI ES 250-W



STOBI ES 50-B	26828	5905339268280	max 25	czarny black
STOBI ES 50-W	26829	5905339268297	max 25	biały white
STOBI ES 250-B	26838	5905339268389	2x max 25	czarny black
STOBI ES 250-W	26839	5905339268396	2x max 25	biały white

[V] 220-240 AC	[Hz] 50	ES-111	GU10	IP 20	5±25	0,5m	CE	EAC	Kanlux
20/20	1+2,5								



Kanlux STOBI ES to linia opraw sufitowych z wymiennym źródłem światła. Wysokiej jakości wykończenie, prosta, geometryczna stylistyka i możliwość 20-stopniowej regulacji kąta padania światła, to tylko część ich zalet. Do lamp Kanlux STOBI ES pasują efektywnie wyglądające źródła światła ES-111 LED z trzonkiem GU10, co sprawia, że doskonale nadają się one do oświetlenia dużych powierzchni - apartamentów, loftów, sklepów, butików, obiektów hotelowych i restauracji.

Materiał obudowy: stop aluminium

Kanlux STOBI ES is a line of ceiling fixtures with a replaceable light source. High-quality finish, simple, geometric design and the possibility of 20-degree light angle adjustment are just part of their advantages. STOBI ES fittings are suitable for spectacular-looking ES-111 LED light sources with GU10 lamp holder, making them ideal for illuminate large areas - apartments, lofts, shops, boutiques, hotel facilities and restaurants.

Enclosure material: aluminum alloy

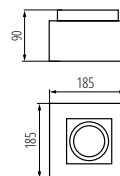

STOBI ES 50

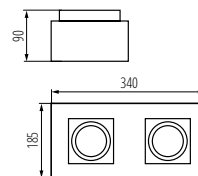

STOBI ES 250



STOBI DLP 50-B



Kanlux STOBI to linia opraw sufitowych z wymiennym źródłem światła. Wykonane są z aluminium i mają możliwość pełnej regulacji kąta padania światła. Wysokiej jakości wykończenie (powierzchnia matowa, piaskowana) i prosta stylistyka sprawiają, że oprawy doskonale nadają się do wyposażenia pomieszczeń domowych, ale również biur i apartamentów.

Materiał obudowy: stop aluminium

The Kanlux STOBI is the line of ceiling fixtures, with a replaceable light source. They are in aluminium with a fully adjustable light-beam angle. The high-quality finish (matte, sanded surface), and simple style, make the fixtures perfect for rooms at home, and also for offices and apartments.

Enclosure material: aluminum alloy



STOBI DLP 50-B	26830	5905339268303	max 25	czarny black
STOBI DLP 50-W	26831	5905339268310	max 25	biały white
STOBI DLP 250-B	26832	5905339268327	2 x max 25	czarny black
STOBI DLP 250-W	26833	5905339268334	2 x max 25	biały white
STOBI DLP 350-B	26834	5905339268341	3 x max 25	czarny black
STOBI DLP 350-W	26835	5905339268358	3 x max 25	biały white
STOBI DLP 450-B	26836	5905339268365	4 x max 25	czarny black
STOBI DLP 450-W	26837	5905339268372	4 x max 25	biały white

[VI] 220-240 AC	[Hz] 50/60	PAR16	GU10	⊕	IP 20	🏠	🌡️ 5+25	⬆️	
🔌	60/45	📦	1+2,5	0,5m	💡	CE	ERC		

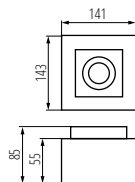

STOBI DLP 50

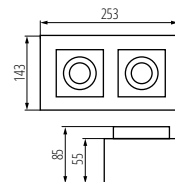

STOBI DLP 250

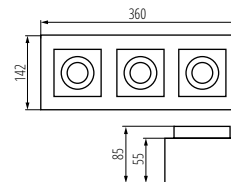

STOBI DLP 350

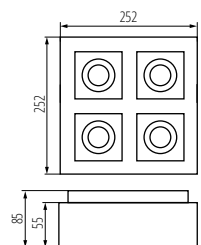

STOBI DLP 450

Kanlux
STOBI

OPRAWA SUFITOWA PUNKTOWA ▶ CEILING-MOUNTED SPOTLIGHT FITTING

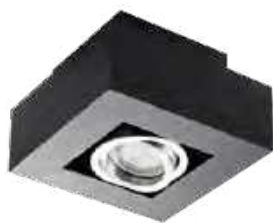

STOBI DLP 50-B

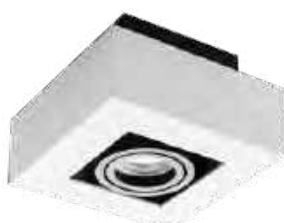

STOBI DLP 50-W



STOBI DLP 250-B

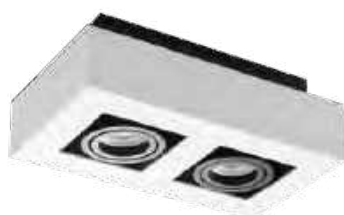

STOBI DLP 250-W



STOBI DLP 350-B



STOBI DLP 350-W



STOBI DLP 450-B



STOBI DLP 450-W



TUBEO ES

OPRAWA SUFITOWA PUNKTOWA ▶ CEILING-MOUNTED SPOTLIGHT FITTING

NEW



TUBEO ES 50-W



TUBEO ES 50-B



TUBEO ES 250-B



TUBEO ES 250-W



Kanlux TUBEO ES to natynkowe oprawy, które umożliwiają nam skierowanie światła w dowolnym kierunku dzięki dwuosiowej regulacji. To o prawy, które charakteryzuje ponadprzeciętna estetyka i doskonała jakość wykonania. Ponadto w oprawach tych umieścimy eleganckie i wydajne źródła światła ES-111. Kanlux TUBEO ES znajdą zastosowanie w obiektach usługowych - jak salony sprzedaży czy butiki, ale również a naszych domach. Należy tu podkreślić unikatowy kształt (zaokrąglone narożniki), który dodaje oprawie subtelności. Oprawy dostępne są w dwóch kolorach - matowej bieli i czerni.

Materiał obudowy: stop aluminium

Kanlux TUBEO ES are surface-mounted luminaires that allow us to direct light in any direction thanks to two-axis adjustment. It is a fixture that is characterized by above-average aesthetics and excellent finish quality. In addition, these luminaires will include elegant and efficient light sources ES-111. Kanlux TUBEO ES will find use in places - such as showrooms or boutiques, but also in our homes. Here you need to highlight the unique shape (rounded corners), which adds a setting of subtlety. The luminaires are available in two colors - matt white and black.

Enclosure material: aluminum alloy



TUBEO ES 50-W	33270	5905339332707	max 25	biały white
TUBEO ES 50-B	33271	5905339332714	max 25	czarny black
TUBEO ES 250-B	33272	5905339332721	2 x max 25	czarny black
TUBEO ES 250-W	33273	5905339332738	2 x max 25	biały white

[V]	[Hz]	ES-111	GU10	IP	20	5+25	
220-240 AC	50						
	20/20		0,75x1,5	0,5m			

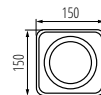
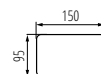

TUBEO ES 50

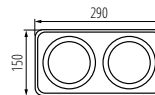
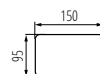

TUBEO ES 250



Kanlux

BLURRO



OPRAWA SUFITOWA PUNKTOWA ► CEILING-MOUNTED SPOTLIGHT FITTING

NEW



BLURRO GU10 CO-B



BLURRO GU10 CO-W



BLURRO 2xGU10 CO-B



BLURRO 2xGU10 CO-W



BLURRO GU10 CO-B	32950	5905339329509	max 10	czarny black
BLURRO GU10 CO-W	32951	5905339329516	max 10	biały white
BLURRO 2xGU10 CO-B	32952	5905339329523	2 x max 10	czarny black
BLURRO 2xGU10 CO-W	32953	5905339329530	2 x max 10	biały white

[V] 220-240 AC	[Hz] 50	PAR16	GU10	IP 20	5+25	0,75+1,5	0,5m	CE	ERC
-------------------	------------	-------	------	----------	------	----------	------	----	-----



HIGH
quality
finish

DESIGN
unique



Kanlux BLURRO to punktowe lampy sufitowe. Nietypowe wzornictwo tych opraw z powodzeniem można zastosować w wielu pomieszczeniach w domu. Swobodna regulacja kierunku strumienia światła to ich dodatkowy atut. Możemy wybrać lampę z jednym punktem świetlnym lub z dwoma. Ich kształt jest pozornie prosty, ale na pewno nienudny. Kanlux BLURRO z powodzeniem oświetli pokój dzienny, kuchnię, ale także przedpokój. W większych pomieszczeniach z powodzeniem zestawimy kilka opraw.

Materiał obudowy: stop aluminium

Kanlux BLURRO are spot ceiling lamps. The unusual design of these luminaires can be successfully used in many rooms in the home. Free adjustment of the light beam direction is their additional advantage. We can choose a lamp with one or two points of light. Their shape is deceptively simple, but definitely boring. Kanlux BLURRO will successfully illuminate the living room, kitchen and hall. In larger rooms, we will successfully combine several luminaires.

Enclosure material: aluminum alloy

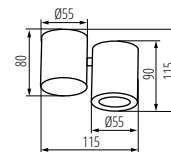

BLURRO GU10 CO

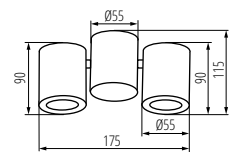

BLURRO 2xGU10 CO

Kanlux BORD

OPRAWA SUFITOWA PUNKTOWA ► CEILING-MOUNTED SPOTLIGHT FITTING



BORD DLP-50-B



Kanlux BORD to popularne oprawy natynkowe. Charakteryzuje je ciekawy i wyrazisty kształt w formie walca. Kanlux BORD gwarantują wyjątkowe oświetlenie umożliwiające podkreślenie niektórych elementów wystroju pomieszczenia i stworzenie przyjemnego nastroju. Nowoczesny design a także elegancka prostota sprawiają, że oprawy te pasują zarówno do wnętrz mieszkalnych jak i komercyjnych.

Materiał obudowy: stop aluminium

Kanlux BORD are popular surface holders. They are characterized by an interesting and expressive shape in the form of a cylinder. Kanlux BORD guarantee exceptional lighting making it possible to emphasize some elements of decor in a room and create pleasant atmosphere. Modern design and elegant simplicity make these holders match both residential interiors and commercial interiors.

Enclosure material: aluminum alloy



BORD DLP-50-AL	22550	5905339225504	max 25	aluminium szczotkowane brushed aluminium
BORD DLP-50-W	22551	5905339225511	max 25	biały mat matte white
BORD DLP-50-B	22552	5905339225528	max 25	czarny mat black matt
BORD DLP-250-AL	22553	5905339225535	2 x max 25	aluminium szczotkowane brushed aluminium
BORD DLP-250-W	22554	5905339225542	2 x max 25	biały mat matte white
BORD DLP-250-B	22555	5905339225559	2 x max 25	czarny mat black matt
BORD DLP-350-W	25800	5905339258007	3 x max 25	biały mat matte white
BORD DLP-350-AL	25802	5905339258021	3 x max 25	aluminium szczotkowane brushed aluminium

[V] 220-240 AC	[Hz] 50/60	PAR16	GU10	IP 20	°C 5+25	CE	EAC	Kanlux
	25	0,75+1,5	0,5m					A A A B C D E

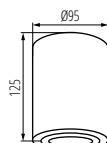

BORD DLP-50

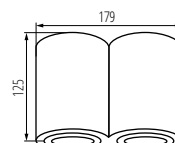

BORD DLP-250

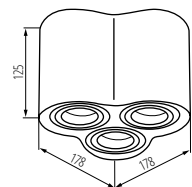

BORD DLP-350

Kanlux
BORD

OPRAWA SUFITOWA PUNKTOWA ▶ CEILING-MOUNTED SPOTLIGHT FITTING



BORD DLP-50-AL



BORD DLP-50-W



BORD DLP-50-B



BORD DLP-250-AL



BORD DLP-250-W



BORD DLP-250-B



BORD DLP-350-AL



BORD DLP-350-W



Kanlux GORD

OPRAWA SUFITOWA PUNKTOWA ► CEILING-MOUNTED SPOTLIGHT FITTING



GORD DLP 50-AL



GORD DLP 50-W



GORD DLP 50-B



GORD DLP 250-W



GORD DLP 250-B



Kanlux GORD to popularne oprawy natynkowe. Charakteryzuje je ciekawy i wyrazisty kształt w formie prostopadłościanu. Kanlux GORD gwarantują wyjątkowe oświetlenie umożliwiające podkreślenie niektórych elementów wystroju pomieszczenia i stworzenie przyjemnego nastroju. Nowoczesny design, a także elegancka prostota sprawiają, że oprawy te pasują zarówno do wnętrz mieszkalnych jak i komercyjnych.

Materiał obudowy: stop aluminium

Kanlux GORD are popular surface holders. They are characterized by an interesting and expressive shape in the form of a cuboid. Kanlux GORD guarantee exceptional lighting making it possible to emphasize some elements of decor in a room and create pleasant atmosphere. Modern design and elegant simplicity make these holders match both residential interiors and commercial interiors.

Enclosure material: aluminum alloy



GORD DLP 50-W	25470	5905339254702	max 25	biały mat matte white
GORD DLP 50-B	25471	5905339254719	max 25	czarny mat black matt
GORD DLP 50-AL	25472	5905339254726	max 25	aluminium szczotkowane brushed aluminium
GORD DLP 250-W	25473	5905339254733	2 x max 25	biały mat matte white
GORD DLP 250-B	25474	5905339254740	2 x max 25	czarny mat black matt

[V] 220-240 AC	[Hz] 50/60	[Lamp] PAR16	[Socket] GU10	[Grounding] ⊕	[IP] IP 20	[Household] 🏠	[Temperature] 5+25	[Mounting] 🔩
[Weight] 25	[Dimensions] 0,75x1,5	[Beam Angle] 0,5m	[Light Source] 💡	[CE]	[EAC]			

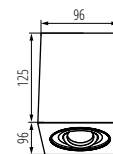

GORD DLP-50

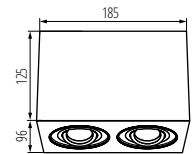

GORD DLP-250

Kanlux

RITI

OPRAWA SUFITOWA PUNKTOWA ► CEILING-MOUNTED SPOTLIGHT FITTING



RITI GU10 W/G



RITI GU10 B/G



Kanlux RITI wykonany jest z aluminium, piaskowana struktura powierzchni jest lakierowana na kolor matowy, natomiast odbłyśnik jest pokryty warstwą złotomiedzianego lakieru z błyszczącym pigmentem. Seria Kanlux RITI cechuje się dobrą jakością wykonania, nowoczesnym wzornictwem. Z powodzeniem możemy zastosować ją jako oświetlenie samodzielne lub zestawiając ze sobą kilka opraw.

Materiał obudowy: stop aluminium

The Kanlux RITI is in aluminium, the sandblasted surface structure is matte-lacquered, and the reflector is covered with a layer of gold-copper lacquer with a shiny pigment. The Kanlux RITI series is characterised by good-quality workmanship and modern design. It can be successfully used as a stand-alone lighting system, or as a combination of several fixtures.

Enclosure material: aluminum alloy



RITI GU10 W/G	27570	5905339275707	max 25	biały / złoty white / gold
RITI GU10 B/G	27571	5905339275714	max 25	czarny / złoty black/gold

[V]	[Hz]	PAR16	GU10	IP	20	5+25
220-240 AC	50/60					
		0,75+1,5	0,5m			

AKCESORIA ► ACCESSORIES

RITI REF SR	27574	5905339275745	Zamienny odbłyśnik RITI REF SR srebrny Replacement reflector RITI REF SR silver
-------------	--------------	---------------	---

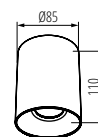

RITI GU10

Kanlux TOLEO

OPRAWA SUFITOWA PUNKTOWA ► CEILING-MOUNTED SPOTLIGHT FITTING



TOLEO DTL50-W



Seria Kanlux TOLEO to nowoczesne, podwieszane oprawy sufitowe. Minimalistyczny design, aluminiowa obudowa oraz modna kolorystyka, czynią je bardzo ciekawym elementem wykończenia wnętrza. Oprawy Kanlux TOLEO dzięki swoim unikatowym, opływowym kształtom, uniwersalnej kolorystyce oraz możliwości samodzielnego wyboru barwy światła idealnie pasują zarówno do wnętrz mieszkalnych jak i powierzchni komercyjnych.

Materiał obudowy: stop aluminium

Kanlux TOLEO series consists of modern, suspended ceiling holders. Minimalistic design, aluminium casing and fashionable colour scheme make them a very interesting element of interior finishing touch. Kanlux TOLEO holders, thanks to their unique, streamlined shapes, universal colour scheme and a possibility of selecting light colour on your own ideally fit into both residential interiors and commercial spaces.

Enclosure material: aluminum alloy



Model	Code	Part No.	Max Bulbs	Finish
TOLEO DT050-B	26110	5905339261106	max 25	czarny mat black matt
TOLEO DT050-W	26111	5905339261113	max 25	biały mat matte white
TOLEO DTL50-B	26113	5905339261137	max 25	czarny mat black matt
TOLEO DTL50-W	26114	5905339261144	max 25	biały mat matte white
TOLEO DTL50-AL	26115	5905339261151	max 25	aluminium szczotkowane brushed aluminium
TOLEO DTL250-B	26119	5905339261199	2 x max 25	czarny mat black matt
TOLEO DTL250-AL	26121	5905339261212	2 x max 25	aluminium szczotkowane brushed aluminium

[V] 220-240 AC	[Hz] 50/60	PAR16	GU10	IP 20	5+25	30/30	0,75+1,5	0,5m	CE	EAC	Kanlux

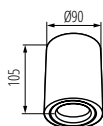

TOLEO DT050

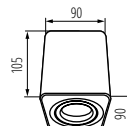

TOLEO DTL50

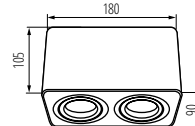

TOLEO DTL250

Kanlux

TOLEO

OPRAWA SUFITOWA PUNKTOWA ▶ CEILING-MOUNTED SPOTLIGHT FITTING



TOLEO DT050-B



TOLEO DT050-W



TOLEO DTL50-B



TOLEO DTL50-W



TOLEO DTL50-AL



TOLEO DTL250-B



TOLEO DTL250-AL



Kanlux ALGO

OPRAWA SUFITOWA PUNKTOWA ► CEILING-MOUNTED SPOTLIGHT FITTING



ALGO GU10 CL-B



ALGO GU10 CL-W



ALGO GU10 CO-B



ALGO GU10 CO-W



Kanlux ALGO to seria opraw, które mają kształt walca lub sześcianu. Pomimo swoich niewielkich rozmiarów efektywnie prezentują się we wnętrzach domowych, czy użyteczności publicznej. Wszystkie modele wykonane są z aluminium, pasują do nich źródła światła o trzonku GU10.

Materiał obudowy: stop aluminium

Kanlux ALGO is a series of holders in the shape of a cylinder or cube. Despite their small dimensions, they look effective in home interiors or public interiors. All models are made of aluminium and light sources with GU10 light bulb base match them.

Enclosure material: aluminum alloy



ALGO GU10 CL-B	27030	5905339270306	max 40	czarny black
ALGO GU10 CL-W	27032	5905339270320	max 40	biały white
ALGO GU10 CO-B	27033	5905339270337	max 40	czarny black
ALGO GU10 CO-W	27035	5905339270351	max 40	biały white

[V] 220-240 AC	[Hz] 50/60	[W] PAR16	[W] GU10	[IP] 20	[E] E14	[T] 5+25	[M] 1+2,5	[L] 0,5m	[C] CE	[E] EAC	[K] Kanlux

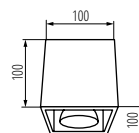

ALGO GU10 CL

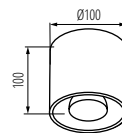

ALGO GU10 CO

Kanlux

DUCE

OPRAWA SUFITOWA PUNKTOWA ► CEILING-MOUNTED SPOTLIGHT FITTING



DUCE AL-DTL50



DUCE AL-DTL50	19950	5905339199508	max 25	aluminium szczotkowane brushed aluminium
DUCE AL-DT050	19951	5905339199515	max 25	aluminium szczotkowane brushed aluminium

[V] 220-240 AC	[Hz] 50/60	PAR16	GU10	IP 20	5+25	0,5m	CE	ERC	Kanlux
	25	1+2,5	0,5m						

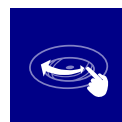

Kanlux DUCE to nowoczesny design i prostota konstrukcji. Świetnie sprawdzi się jako oświetlenie podstawowe lub uzupełniające, zarówno we wnętrzach prywatnych, jak i przestrzeniach użyteczności publicznej. Jest polecana tam, gdzie dyskretnym oświetleniem, chcemy zaakcentować ciekawą aranżację. Możliwość regulacji wychylenia źródła światła o kąt 25°, pozwala kierować strumień świetlny w pożądane miejsce lub punkt.

Materiał obudowy: stop aluminium

Kanlux DUCE is a modern design and simplicity of construction. It will work well as basic or additional lighting both in private interiors and public spaces. It is recommended in places where you want to emphasize an interesting arrangement by means of discrete lighting. A possibility of adjusting a deflection of light source by the angle of 25° allows to direct the light stream into a desirable place or point.

Enclosure material: aluminum alloy

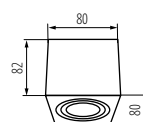

DUCE AL-DTL

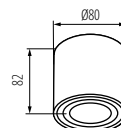

DUCE AL-DT0

Kanlux

TORIM

OPRAWA SUFITOWA PUNKTOWA ► CEILING-MOUNTED SPOTLIGHT FITTING



TORIM DLP-250 B-W



TORIM DLP-250 B-W	28463	5905339284631	2 x max 35	czarny / biały black/white
-------------------	--------------	---------------	------------	------------------------------

[V] 220-240 AC	[Hz] 50/60	PAR16	GU10	IP 20	5+25	0,5m	CE	ERC	Kanlux
	15	1+2,5	0,5m						



Kanlux TORIM to zestawienie bieli i czerni, do którego dodaliśmy proste geometryczne kształty. Kanlux TORIM to sufitowe oprawy punktowe wykonane z blachy stalowej zaprojektowane z myślą o wnętrzach nowoczesnych. Do opraw Kanlux TORIM pasują żarówki z trzonkiem GU10, a sam kierunek padania światła możemy regulować w zakresie 15 stopni.

Materiał obudowy: stal

The Kanlux TORIM is a combination of black and white, with the addition of simple geometric shapes. The Kanlux TORIM is a ceiling-point fixture in steel sheet, designed for modern interiors. The Kanlux TORIM fixtures are compatible with GU10 cap bulbs, and the light-beam angle can be adjusted within the range of 15°.

Enclosure material: steel

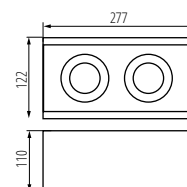

TORIM DLP-250

Kanlux MERSA

PLAFONIERA ► CEILING LIGHT FITTING



MERSA 300-B/M



MERSA 300-W/M



MERSA 380-W/M



MERSA 300-B/M



MERSA 380-B/M



Starannie wykonane, drewniane oprawy Kanlux MERSA otwierają możliwość ciekawej aranżacji pomieszczeń. Efektowna obudowa w połączeniu z satynowym szkłem, które zapewnia równomierne rozproszenie światła, nada niepowtarzalnego charakteru każdemu wnętrzu.

Materiał obudowy: drewno

Materiał klosza: szkło

The carefully made wooden Kanlux MERSA fixtures create the possibility of an interesting room arrangement. Its impressive casing combined with satin glass, which ensures a uniform distribution of light, will give each interior a unique character.

Enclosure material: Wood

Lampshade material: glass



MERSA 300-W/M	25675	5905339256751	2 x max 60	E27	GLS/CFL/LED	biały mat matte white
MERSA 380-W/M	25678	5905339256782	3 x max 40	E27	GLS/CFL/LED	biały mat matte white
MERSA 300-B/M	29050	5905339290502	2 x max 60	E27	GLS/CFL/LED	czarny mat black matt
MERSA 380-B/M	29051	5905339290519	3 x max 40	E27	GLS/CFL/LED	czarny mat black matt

[V] 220-240 AC	[Hz] 50/60	IP 20	House icon	Temperature icon 5÷25	Light bulb icon	CE	EAC	Kanlux logo
Light bulb icon	Light bulb icon	Light bulb icon	Light bulb icon	Light bulb icon	Light bulb icon	Light bulb icon	Light bulb icon	Light bulb icon
1+2,5	0,5m							

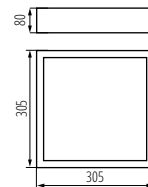

MERSA 300

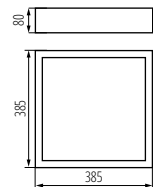

MERSA 380

Kanlux JASMIN

PLAFONIERA ► CEILING LIGHT FITTING



JASMIN 270-WE

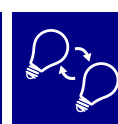

Originalne, a zarazem stylowe okrągłe oprawy Kanlux JASMIN cechują się nowoczesnym i atrakcyjnym designem. Obudowa plafoniera wykonana jest z drewna oraz szkła trawionego (satynowego), które zapewnia równomierne rozproszenie światła. Klasyczne połączenie drewna i szkła sprawia, że jest to bardzo uniwersalne rozwiązanie oświetleniowe.

Materiał obudowy: drewno
Materiał klosza: szkło

The original and at the same time stylish round holders - Kanlux JASMIN are characterized by modern and attractive design. The casing of the ceiling light fixture is made of wood and etched (satin) glass which ensures even dispersal of light. The classic combination of wood and glass makes it a very universal lighting solution.

Enclosure material: Wood
Lampshade material: glass



Model	Code	Product ID	Max Power	Base	Compatible Bulbs	Finish
JASMIN 270-WE	23120	5905339231208	max 60	E27	GLS/CFL/LED	wenge
JASMIN 370-WE	23121	5905339231215	2 x max 60	E27	GLS/CFL/LED	wenge
JASMIN 470-WE	23122	5905339231222	3 x max 40	E27	GLS/CFL/LED	wenge
JASMIN 270-W	23123	5905339231239	max 60	E27	GLS/CFL/LED	dąb sonoma Sonoma oak
JASMIN 370-W	23124	5905339231246	2 x max 60	E27	GLS/CFL/LED	dąb sonoma Sonoma oak
JASMIN 470-W	23125	5905339231253	3 x max 40	E27	GLS/CFL/LED	dąb sonoma Sonoma oak
JASMIN 270-W/M	23126	5905339231260	max 60	E27	GLS/CFL/LED	biały mat matte white
JASMIN 370-W/M	23127	5905339231277	2 x max 60	E27	GLS/CFL/LED	biały mat matte white
JASMIN 470-W/M	23128	5905339231284	3 x max 40	E27	GLS/CFL/LED	biały mat matte white
JASMIN 470-A	23129	5905339231291	3 x max 40	E27	GLS/CFL/LED	antracyt anthracite
JASMIN 370-A	29200	5905339292001	2 x max 60	E27	GLS/CFL/LED	antracyt anthracite
JASMIN WE-W	23756	5905339237569	max 60	E27	GLS/CFL/LED	wenge
JASMIN W-W	23757	5905339237576	max 60	E27	GLS/CFL/LED	dąb sonoma Sonoma oak
JASMIN W/M-W	23758	5905339237583	max 60	E27	GLS/CFL/LED	biały mat matte white
JASMIN 470-W-H	23752	5905339237521	3 x max 40	E27	GLS/CFL/LED	biały mat matte white

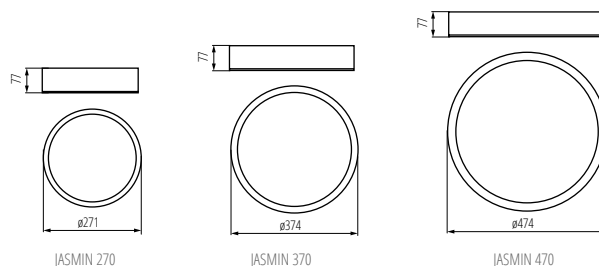
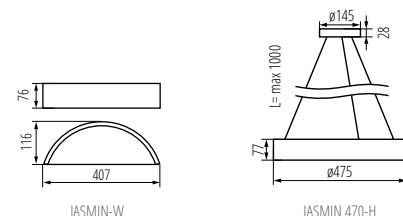

[V] 220-240 AC	[Hz] 50/60	⏚ IP 20	🏠 5+25	🔌 E27	🔧 E27	📏 1+2,5	📏 0,5m	CE	ERL	Kanlux
-------------------	---------------	------------	-----------	----------	----------	------------	-----------	----	-----	--------



TIVA 1130 DDR/ML-SN



TIVA 1030 SDR/ML-SN



TIVA 1030 SDR/ML-DB



TIVA 1130 DDR/ML-OL



TIVA 1030 1/2DR/ML-SN



TIVA 1030 1/2DR/ML-DB



TIVA 1030 1/2DR/ML-OL



Seria plafonier i kinkietów Kanlux TIVA to lampy w których połączono drewno z białym, mlecznym kloszem. Jest to ciekawe wzorniczo zestawienie. Samodzielnie dobierzemy źródło światła o trzonku E27.

Materiał obudowy: drewno

Materiał klosza: szkło

The series of the ceiling light fixtures and wall lamps Kanlux TIVA are lamps which combine wood with a white, milky lampshade. It is an interesting combination in terms of design. You can select the light source with E27 light bulb base on your own.

Enclosure material: Wood

Lampshade material: glass



TIVA 1130 DDR/ML-SN	70710	5905339707109	2 x max 60	E27	GLS/CFL/LED	sosna pine
TIVA 1130 DDR/ML-DB	70711	5905339707116	2 x max 60	E27	GLS/CFL/LED	dąb oak
TIVA 1130 DDR/ML-OL	70717	5905339707178	2 x max 60	E27	GLS/CFL/LED	olcha alder
TIVA 1030 SDR/ML-SN	70720	5905339707208	max 60	E27	GLS/CFL/LED	sosna pine
TIVA 1030 SDR/ML-DB	70721	5905339707215	max 60	E27	GLS/CFL/LED	dąb oak
TIVA 1030 SDR/ML-OL	70727	5905339707277	max 60	E27	GLS/CFL/LED	olcha alder
TIVA 1030 1/2DR/ML-SN	70740	5905339707406	max 60	E27	GLS/CFL/LED	sosna pine
TIVA 1030 1/2DR/ML-DB	70741	5905339707413	max 60	E27	GLS/CFL/LED	dąb oak
TIVA 1030 1/2DR/ML-OL	70747	5905339707475	max 60	E27	GLS/CFL/LED	olcha alder

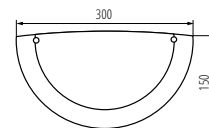

TIVA 1030 1/2DR

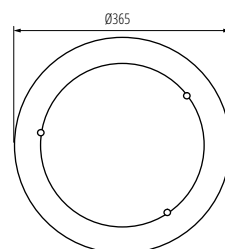

TIVA 1130 DDR

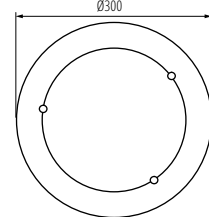

TIVA 1030 SDR

[V] 220-240 AC	[Hz] 50/60	[IP] 20	[°C] 5-25	[m] 0,5m	[CE]	[EAC]
[1+2,5]	[0,5m]	[E]	[E]	[E]	[E]	[E]



Kanlux ARDEA

PLAFONIERA ► CEILING LIGHT FITTING

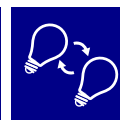

ARDEA 1030 S/ML-BI

Plafon Kanlux ARDEA to oświetlenie uniwersalne. Możemy wykorzystać go do stworzenia kącika wypoczynkowego w salonie lub zamontować go w przedpokoju nad lustrem. Produkt będzie się dobrze prezentował na ścianach i sufitach. Charakteryzuje się uniwersalnym wyglądem – zawdzięcza to prostej stylistyce. Do plafonu Kanlux ARDEA należy dobrać źródło światła z gwintem E27.

Powierzchnia klosza równomiernie rozpraszająca światło

Materiał obudowy: stal

Materiał klosza: szkło

Kanlux ARDEA plafond is universal lighting. It can be used to create a relaxation niche in a living room or mounted in a hall above a mirror. The product will look good on walls and ceilings. It is characterized by universal appearance - thanks to simple stylistics. A light source with E27 thread must be added to the Kanlux ARDEA plafond.

The light is diffused uniformly over the diffuser surface

Enclosure material: steel

Lampshade material: glass



ARDEA 1030 SG/ML-SR	70761	5905339707611	max 60	E27	GLS/CFL/LED	chrom chrome
ARDEA 1130 D/ML-BI	70782	5905339707826	2 x max 60	E27	GLS/CFL/LED	biały white
ARDEA 1030 S/ML-BI	70784	5905339707840	max 60	E27	GLS/CFL/LED	biały white
ARDEA 1030 M/ML-BI	70786	5905339707864	max 60	E27	GLS/CFL/LED	biały white
ARDEA 1030 1/2/ML-BI	70788	5905339707888	max 60	E27	GLS/CFL/LED	biały white

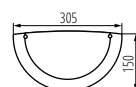

ARDEA 1030 1/2/ML

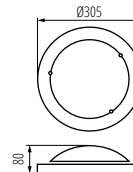

ARDEA 1030 S

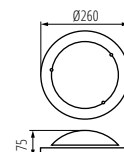

ARDEA 1030 M

[V] 220-240 AC	[Hz] 50/60	⏚ IP 20	🏠 5+25	🔌 1+2,5	📏 0,5m	🔌 CE	🔌 EAC	📦 Kanlux
-------------------	---------------	---------------	-----------	------------	-----------	---------	----------	-------------

Kanlux PLAFMIN

PLAFONIERA ► CEILING LIGHT FITTING

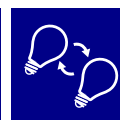

PLAFMIN O

Kanlux PLAFMIN to najbardziej uniwersalna plafoniera w naszej ofercie. Biały kolor, neutralny kształt półkuli, brak jakichkolwiek ozdób i samodzielny wybór źródła światła. Zastosujemy ją w każdym wnętrzu (IP20), szczególnie polecamy ją do hoteli, restauracji i wnętrz domowych w skandynawskim lub minimalistycznym stylu.

Materiał obudowy: tworzywo sztuczne

Materiał klosza: tworzywo sztuczne

Kanlux PLAFMIN is the most universal ceiling light fixture in our offer. White colour, neutral shape of hemisphere, lack of any ornaments and independent selection of light source. It can be used in each interior (IP20), it is particularly recommended to hotels, restaurants and home interiors in the Scandinavian or minimalist style.

Enclosure material: plastic

Lampshade material: plastic



PLAFMIN O	25690	5905339256904	max 40	E27	GLS/CFL/LED	biały white
-----------	--------------	---------------	--------	-----	-------------	---------------

[V] 220-240 AC	[Hz] 50/60	⏚ IP 20	🏠 5+25	🔌 1+2,5	📏 0,5m	🔌 CE	🔌 EAC	📦 Kanlux
-------------------	---------------	---------------	-----------	------------	-----------	---------	----------	-------------

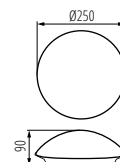

PLAFMIN O



LAURIN EL-10 B



LAURIN EL-10 W	29120	5905339291202	max 35	biały white
LAURIN EL-10 B	29121	5905339291219	max 35	czarny black
LAURIN EL-21 W	29122	5905339291226	2 x max 35	biały white
LAURIN EL-21 B	29123	5905339291233	2 x max 35	czarny black
LAURIN EL-31 W	29124	5905339291240	3 x max 35	biały white
LAURIN EL-31 B	29125	5905339291257	3 x max 35	czarny black
LAURIN EL-30 W	29126	5905339291264	3 x max 35	biały white
LAURIN EL-30 B	29127	5905339291271	3 x max 35	czarny black
LAURIN EL-40 W	29128	5905339291288	4 x max 35	biały white
LAURIN EL-40 B	29129	5905339291295	4 x max 35	czarny black



Spoty Kanlux LAURIN to bardzo duży wybór kierunkowych lamp sufitowo-ściennych. Proste i minimalistyczne wzornictwo z powodzeniem możecie zastosować w wielu pomieszczeniach w domu. Swobodna regulacja kierunku strumienia światła to dodatkowy atut tych opraw.

Materiał obudowy: stop aluminium

Kanlux LAURIN spotlights provide a very large selection of directional ceiling and wall lamps. The simple and minimalist design can be successfully used in many rooms in the house. Free adjustment of the luminous flux direction is an additional advantage of these fixtures.

Enclosure material: aluminum alloy

[V] 220-240 AC	[Hz] 50/60	PAR16	GU10	IP 20	5+25	0,5m	CE	ERL
310	90	1+2,5	0,5m					

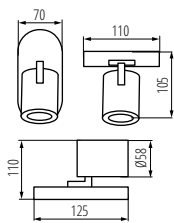

LAURIN EL-10

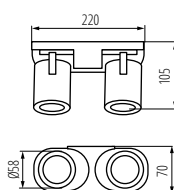

LAURIN EL-21

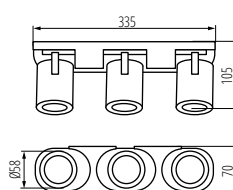

LAURIN EL-31

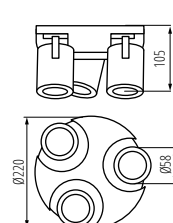

LAURIN EL-30

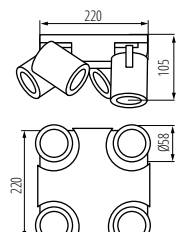

LAURIN EL-40

Kanlux

LAURIN

OPRAWA ŚCIENNO-SUFITOWA ► WALL & CEILING LIGHTING FITTING



LAURIN EL-10 W



LAURIN EL-21 W



LAURIN EL-21 B



LAURIN EL-31 W



LAURIN EL-31 B



LAURIN EL-30 W



LAURIN EL-30 B



LAURIN EL-40 W



LAURIN EL-40 B

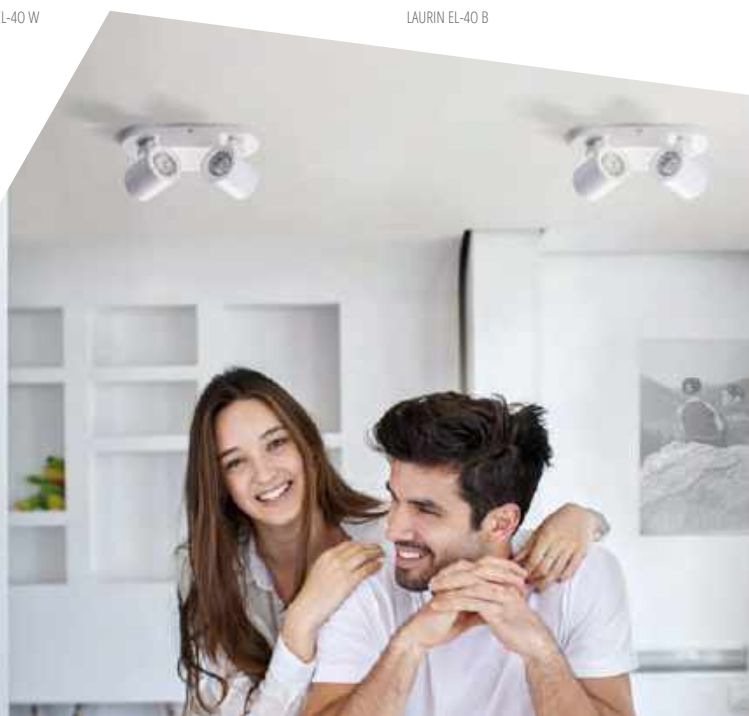

Kanlux SEMPRA



OPRAWA ŚCIENNO-SUFITOWA ► WALL & CEILING LIGHTING FITTING

NEW



SEMPRA EL-11 B-SR



Kanlux SEMBRA to seria eleganckich spotów w kolorze biało-srebrnym i czarno-srebrnym. Dzięki oryginalnej listwie, na której zamontowane są klosze, wszystkie modele sprawdzą się zarówno w zastosowaniu sufitowym, jak i ściennym - to daje nam nowe możliwości aranżacji oświetlenia pomieszczeń. Bardzo ciekawym rozwiązaniem jest możliwość pionowego montażu na ścianie nawet oprawy z 4 źródłami światła.

Materiał obudowy: stal

Kanlux SEMBRA is a series of elegant spots in black and white or black and silver. Thanks to the original slat, on which the lampshades are mounted, all models will be perfect for both ceiling and wall applications - this gives us new possibilities of arranging room lighting. A very interesting solution is the possibility of vertical mounting of a luminaire with up to 4 light sources on the wall.

Enclosure material: steel



Model	Code	Part No.	Max. H.	Color
SEMPRA EL-11 W-SR	33090	5905339330901	max 35	biały white
SEMPRA EL-11 B-SR	33091	5905339330918	max 35	czarny black
SEMPRA EL-21 W-SR	33092	5905339330925	2 x max 35	biały white
SEMPRA EL-21 B-SR	33093	5905339330932	2 x max 35	czarny black
SEMPRA EL-31 W-SR	33094	5905339330949	3 x max 35	biały white
SEMPRA EL-31 B-SR	33095	5905339330956	3 x max 35	czarny black
SEMPRA EL-41 W-SR	33096	5905339330963	4 x max 35	biały white
SEMPRA EL-41 B-SR	33097	5905339330970	4 x max 35	czarny black

[V] 220-240 AC	[Hz] 50	PAR16	GU10	IP 20	5+25 °C	CE	EAC
310	90	0,75x1,5	0,5m				



SEMPRA EL-11

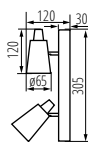

SEMPRA EL-21



SEMPRA EL-31

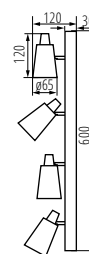

SEMPRA EL-41

Kanlux

SEMPRA

OPRAWA ŚCIENNO-SUFITOWA ► WALL & CEILING LIGHTING FITTING



SEMPPRA EL-11 W-SR



SEMPPRA EL-21 W-SR



SEMPPRA EL-21 B-SR



SEMPPRA EL-31 W-SR



SEMPPRA EL-31 B-SR



SEMPPRA EL-41 W-SR



SEMPPRA EL-41 B-SR





ENALI EL-10 W



ENALI EL-10 W	28760	5905339287601	max 35	biały white
ENALI EL-10 B	28761	5905339287618	max 35	czarny black
ENALI EL-21 W	28762	5905339287625	2 x max 35	biały white
ENALI EL-21 B	28763	5905339287632	2 x max 35	czarny black
ENALI EL-30 W	28764	5905339287649	3 x max 35	biały white
ENALI EL-30 B	28765	5905339287656	3 x max 35	czarny black
ENALI EL-31 W	28766	5905339287663	3 x max 35	biały white
ENALI EL-31 B	28767	5905339287670	3 x max 35	czarny black
ENALI EL-41 W	28768	5905339287687	4 x max 35	biały white
ENALI EL-41 B	28769	5905339287694	4 x max 35	czarny black



Kanlux ENALI to rodzina opraw punktowych (sufitowo ściennych). Dzięki regulowanym przegubom możemy swobodnie ustawić kąt padania światła. Oprawy idealnie pasują do wnętrz w stylu skandynawskim, ich kształt podkreśli charakter wnętrz retro, a chromowane dodatki dodadzą subtelnego szlifów wnętrzom nowoczesnym.

Materiał obudowy: stal
Materiał klosza: stal

The Kanlux ENALI is a family of point fixtures (ceiling and wall). Thanks to the adjustable joints you can freely set the light-beam angle. The fixtures fit perfectly into Scandinavian style interiors, their shape will emphasise the character of retro interiors, and the chrome accessories will add a subtle touch to modern interiors.

Enclosure material: steel
Lampshade material: steel

[V] 220-240 AC	[Hz] 50/60	PAR16	GU10		IP 20		5+25	
31°	90°		1+2,5	0,5m		CE	ERL	

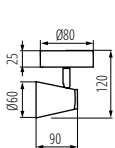

ENALI EL-10

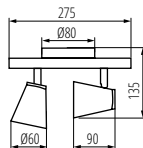

ENALI EL-21

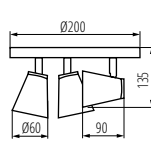

ENALI EL-30

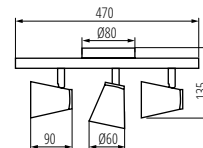

ENALI EL-31

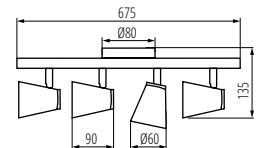

ENALI EL-41

Kanlux

ENALI

OPRAWA ŚCIENNO-SUFITOWA ► WALL & CEILING LIGHTING FITTING



ENALI EL-10 B



ENALI EL-21 W



ENALI EL-21 B



ENALI EL-30 W



ENALI EL-30 B



ENALI EL-31 W



ENALI EL-31 B



ENALI EL-41 W



ENALI EL-41 B





MILENO EL-10 B-AG



MILENO EL-10 B-AG	29110	5905339291103	max 35	czarny / złoty black/gold
MILENO EL-10 ASR-AN	29111	5905339291110	max 35	srebrny / miedziany silver / copper
MILENO EL-30 B-AG	29112	5905339291127	3 x max 35	czarny / złoty black/gold
MILENO EL-30 ASR-AN	29113	5905339291134	3 x max 35	srebrny / miedziany silver / copper
MILENO EL-2I B-AG	29114	5905339291141	2 x max 35	czarny / złoty black/gold
MILENO EL-2I ASR-AN	29115	5905339291158	2 x max 35	srebrny / miedziany silver / copper
MILENO EL-3I B-AG	29116	5905339291165	3 x max 35	czarny / złoty black/gold
MILENO EL-3I ASR-AN	29117	5905339291172	3 x max 35	srebrny / miedziany silver / copper
MILENO EL-4I B-AG	29118	5905339291189	4 x max 35	czarny / złoty black/gold
MILENO EL-4I ASR-AN	29119	5905339291196	4 x max 35	srebrny / miedziany silver / copper

[V] 220-240 AC	[Hz] 50/60	PAR16	GU10		IP 20		5+25		[°] 300
80	1+2,5	0,5m				 			

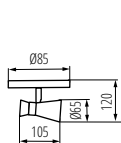

MILENO EL-10

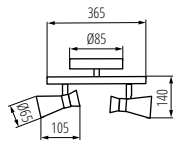

MILENO EL-2I

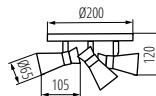

MILENO EL-30

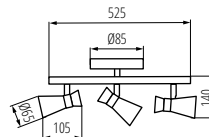

MILENO EL-3I

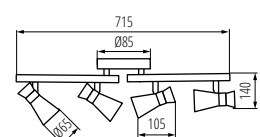

MILENO EL-4I



Kanlux MILENO to odpowiedź na najnowsze trendy. Ciekawe wzornictwo i niebanalny kształt to atuty tej serii. Bardzo duża liczba modeli opraw Kanlux MILENO to dużo większe możliwości aranżacyjne.

Materiał obudowy: stal

Kanlux MILENO follows the latest trends. The advantages of this series are its interesting design and original shape. The very-large number of Kanlux MILENO fixture models means many-more arrangement possibilities.

Enclosure material: steel

Kanlux

MILENO

OPRAWA ŚCIENNO-SUFITOWA ► WALL & CEILING LIGHTING FITTING



MILENO EL-10 ASR-AN



MILENO EL-21 B-AG



MILENO EL-21 ASR-AN



MILENO EL-30 B-AG



MILENO EL-30 ASR-AN



MILENO EL-31 B-AG



MILENO EL-31 ASR-AN



MILENO EL-41 B-AG



MILENO EL-41 ASR-AN



Kanlux EVELI

OPRAWA ŚCIENNO-SUFITOWA ► WALL & CEILING LIGHTING FITTING



EVELI EL-10



EVELI EL-21



EVELI EL-30



EVELI EL-41



Kanlux EVELI to rodzina opraw, która wyróżnia się bardzo ciekawym wzornictwem. Klosz z dymionego szkła idealnie wpisuje się we wnętrza industrialne, sprawdzi się nie tylko w domu, ale nada również klimatycznego charakteru obiektom HoReCa.

Materiał obudowy: stal
Materiał klosza: szkło

Kanlux EVELI is a family of fixtures which stands out thanks to its very-interesting design. The smoked-glass lampshade fits in with industrial interiors perfectly, and it will prove itself not only at home, but will also provide an appropriate atmosphere in HoReCa interiors.

Enclosure material: steel
Lampshade material: glass



EVELI EL-10	29100	5905339291004	max 35	srebrny silver
EVELI EL-21	29101	5905339291011	2 x max 35	srebrny silver
EVELI EL-30	29102	5905339291028	3 x max 35	srebrny silver
EVELI EL-41	29103	5905339291035	4 x max 35	srebrny silver

[V]	[Hz]	G9	G9	IP	IP	5+25	CE	EAC
220-240 AC	50/60			20				
300	90	1+2,5	0,5m					

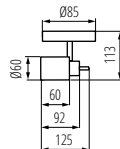

EVELI EL-10

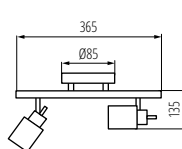

EVELI EL-21

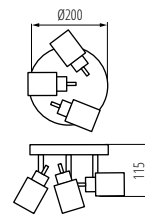

EVELI EL-30

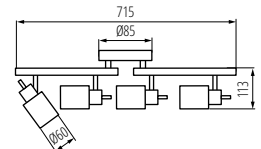

EVELI EL-41

Kanlux GLASO

OPRAWA ŚCIENNO-SUFITOWA ► WALL & CEILING LIGHTING FITTING



GLASO EL-10



GLASO EL-21



GLASO EL-31



GLASO EL-30



GLASO EL-41



GLASO EL-10	19640	5905339196408	max 40	chrom chrome
GLASO EL-21	19641	5905339196415	2 x max 40	chrom chrome
GLASO EL-31	19642	5905339196422	3 x max 40	chrom chrome
GLASO EL-41	19643	5905339196439	4 x max 40	chrom chrome
GLASO EL-30	19644	5905339196446	3 x max 40	chrom chrome

[VI] 220-240 AC	[Hz] 50/60				IP 20		 5+25	
 320	 90		 1+2,5	 0,5m		CE	ERC	

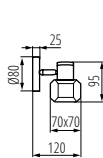

GLASO EL-10

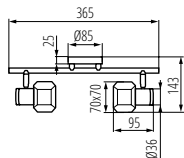

GLASO EL-21

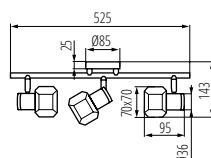

GLASO EL-31

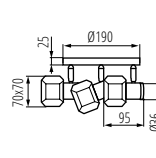

GLASO EL-30

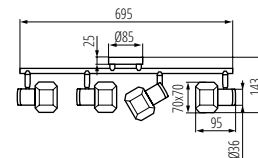

GLASO EL-41



Kanlux GLASO, to rodzina opraw punktowych (sufitowo-ściennych). Dzięki regulacji możemy swobodnie ustawić kąt padania światła. Kształt opraw i ciekawe wzornictwo szklanych kloszy podkreślają charakter wnętrz retro, a chromowane dodatki dodają subtelności szlifem nowoczesnym.

Materiał obudowy: stal

Materiał klosza: szkło

Kanlux GLASO is a family of spot beam lamps (ceiling and wall). Thanks to adjustment, you can freely set the angle of light. The shape of the lamps and interesting design of the glass lampshades emphasize a character of retro interiors and chromium-plated additives will add a subtle touch to modern interiors.

Enclosure material: steel

Lampshade material: glass

Kanlux SONDA

OPRAWA ŚCIENNO-SUFITOWA ► WALL & CEILING LIGHTING FITTING



SONDA EL-1L



SONDA EL-2J



SONDA EL-3J



SONDA EL-4L



SONDA EL-1L	04795	5905339047953	max 50	chrom mat chrome matte
SONDA EL-2J	04796	5905339047960	2 x max 50	chrom mat chrome matte
SONDA EL-3J	04797	5905339047977	3 x max 50	chrom mat chrome matte
SONDA EL-4L	04798	5905339047984	4 x max 50	chrom mat chrome matte

[V] 220-240 AC	[Hz] 50/60						
320	90	1+2,5	0,5m				

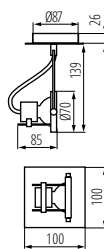
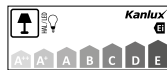

SONDA EL-1L

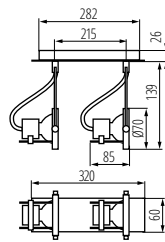

SONDA EL-2J

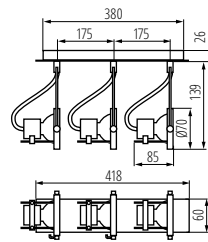

SONDA EL-3J

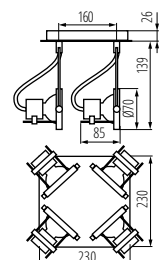

SONDA EL-4L



Futurystyczna lampa Kanlux SONDA o nietypowym kształcie jest idealna przede wszystkim do wnętrz urządzonych w nowoczesnym stylu. Wykonana z całości ze stali, stanie się wyrazistą ozdobą każdego pomieszczenia. Reflektor możemy ustawić w dowolnej pozycji kierując światło w pożądaną stronę.

Materiał obudowy: stal

The Kanlux SONDA futuristic lamp in an untypical shape is mainly ideal for interiors arranged in the modern style. Made of steel in its entirety will become an expressive ornament of each room. The reflector can be positioned freely, directing light into a desirable place.

Enclosure material: steel

Kanlux MOLI

OPRAWA ŚCIENNO-SUFITOWA ► WALL & CEILING LIGHTING FITTING



MOLI EL-10



MOLI EL-21



MOLI EL-30



MOLI EL-41



Kanlux MOLI to rodzina opraw przywodząca na myśl styl retro. Satynowy chrom o opływowych kształtach stanie się ozdobą wnętrz domowych. Oprawy współpracują ze źródłami światła z trzonkiem GU10.

Materiał obudowy: stal

Kanlux MOLI is a family of holders in retro style. The satin chromium in streamlined shapes will become an ornament of home interiors. The holders cooperate with light sources with GU10 light bulb base.

Enclosure material: steel



MOLI EL-10	07085	5905339070852	max 50	chrom mat chrome matte
MOLI EL-21	07086	5905339070869	2 x max 50	chrom mat chrome matte
MOLI EL-30	07087	5905339070876	3 x max 50	chrom mat chrome matte
MOLI EL-41	07088	5905339070883	4 x max 50	chrom mat chrome matte

[V] 220-240 AC	[Hz] 50/60				IP 20		 5+25	
 320	 90	 1+2,5	 0,5m		CE	ERL		

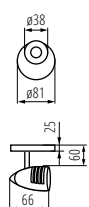

MOLI EL-10

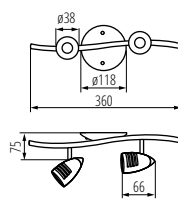

MOLI EL-21

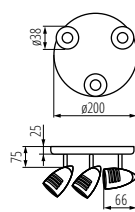

MOLI EL-30

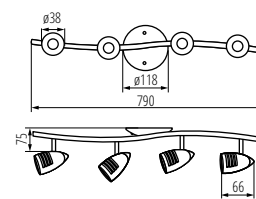

MOLI EL-41

SILMA LED

OPRAWA ŚCIENNO-SUFITOWA LED ► WALL/CEILING LED FIXTURE



SILMA LED EL-10



Kanlux SILMA to seria opraw o nietypowym, futurystycznym kształcie. Ciekawy design opraw to przede wszystkim płaskie klosze tych opraw ze zintegrowanymi źródłami światła LED. Możemy wybrać oprawę posiadającą od 1 do 4 punktów świetlnych. Polecamy do nowoczesnych, modernistycznych wnętrz.

Materiał obudowy: stal
Materiał klosza: szkło

Kanlux SILMA is a series of ceiling lamps in an untypical, futuristic shape. Interesting design of the lighting fixtures means, first of all, flat lampshades of these lamps with integrated LED light sources. You can choose a lamp having from 1 to 4 light points. They are recommended for modern, modernistic interiors.

Enclosure material: steel
Lampshade material: glass



SILMA LED EL-20



SILMA LED EL-30



SILMA LED EL-40

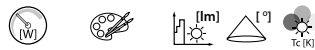

Model	Code	Points	Material	Height	Beam Angle	Beam Diameter	Temp
SILMA LED EL-10	24440	5905339244406	6 chrom chrome	320	95	3000	
SILMA LED EL-20	24441	5905339244413	2 x 6 chrom chrome	2 x 320	95	3000	
SILMA LED EL-30	24442	5905339244420	3 x 6 chrom chrome	3 x 320	95	3000	
SILMA LED EL-40	24443	5905339244437	4 x 6 chrom chrome	4 x 320	95	3000	

[V]	[Hz]	[h]	[lm]	[°]	[K]	[Ra]	[COB]	[IP]	[House]
220-240 AC	50/60	≥12000	17000	≤6x MacAdam	≥80	COB		IP 20	
[°C]	[°]	[°]	[mm]	[m]	[mm]	[m]	[m]	[CE]	[EAC]
5+25	320	90	1+2,5	0,5m					

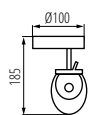

SILMA LED EL-10

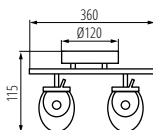

SILMA LED EL-20

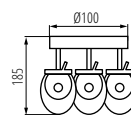

SILMA LED EL-30

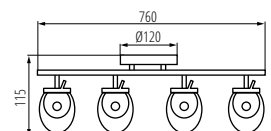

SILMA LED EL-40

TUME LED

OPRAWA ŚCIENNO-SUFITOWA LED ► WALL/CEILING LED FIXTURE



TUME LED EL-10



TUME LED EL-20

TUME LED EL-30



TUME LED EL-40

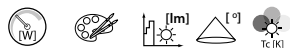

TUME LED EL-10	24450	5905339244505	6	szary grey	500	65	3000
TUME LED EL-20	24451	5905339244512	2 x 6	szary grey	2 x 500	65	3000
TUME LED EL-30	24452	5905339244529	3 x 6	szary grey	3 x 500	65	3000
TUME LED EL-40	24453	5905339244536	4 x 6	szary grey	4 x 500	65	3000

[V] 220-240 AC	[Hz] 50/60	[h] ≥12000	[h] 17000	[lm] elliptic ≤ 6x MacAdam	Ra ≥80	COB	IP 20
	[°C] 5÷25	[°] 320	[°] 90	[mm] 1+2,5	[mm] 0,5m	CE	ERC

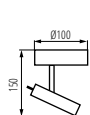

TUME LED EL-10

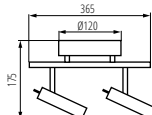

TUME LED EL-20

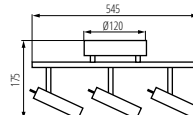

TUME LED EL-30

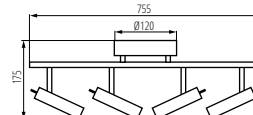

TUME LED EL-40



Kanlux TUME atrakcyjna wizualnie i użytkowo nowoczesna seria opraw ścienna-sufitowych. Oprawy posiadają zintegrowane źródło światła LED COB o ciepłej barwie. Kanlux TUME daje możliwość pełnej regulacji kierunku padania strumienia świetlnego. Nietuzinkowy design sprawia, że oprawa ta świetnie wygląda w nowoczesnych wnętrzach domowych, hotelach i restauracjach.

Materiał obudowy: stal

Kanlux TUME is a visually attractive and attractive in terms of use modern series of wall and ceiling lamps. These lamps have an integrated LED COB light source with warm colour. Kanlux TUME enables full adjustment of the direction of the light stream. The original design makes this lamp look perfect in modern home interiors, hotels and restaurants.

Enclosure material: steel

Kanlux

MINI RITI

OPRAWA SUFITOWA PUNKTOWA ► CEILING-MOUNTED SPOTLIGHT FITTING

NEW



MINI RITI GU10 B/G



MINI RITI GU10 W/G



MINI RITI GU10 B/W



MINI RITI GU10 B/B



MINI RITI GU10 W/W

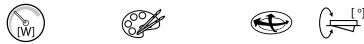

MINI RITI GU10 B/G	27575	5905339275752	max 25	czarny / złoty black/gold	brak none
MINI RITI GU10 W/G	27576	5905339275769	max 25	biały / złoty white / gold	brak none
MINI RITI GU10 B/W	27577	5905339275776	max 25	czarny / biały black/white	brak none
MINI RITI GU10 B/B	27578	5905339275783	max 25	czarny black	brak none
MINI RITI GU10 W/W	27579	5905339275790	max 25	biały white	brak none

[V] 220-240 AC	[Hz] 50	PAR16	GU10	IP 20
5+25	068+71	1+2,5	0,5m	CE EAC

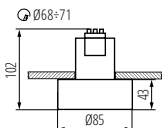

MINI RITI GU10



Kanlux MINI RITI to mniejsza, nieco niższa wersja popularnej oprawy Kanlux RITI. Przygotowaliśmy ją w dwóch wersjach - białej i czarnej, każda z opraw ma jednak kilka wersji kolorystycznych odbłyśnika - biały, czarny lub złoty. Jesteśmy pewni, że tak szeroki wybór to większe możliwości dopasowania opraw Kanlux MINI RITI do typu wnętrza, w którym je umieścimy. Jeżeli będziemy chcieli postawić na ekstrawagancję to możemy łączyć ze sobą różne kolory opraw, a także zestawić je z Kanlux RITI. Razem stworzą harmonijną, acz niecodzienną oprawę oświetleniową pomieszczenia. Do opraw Kanlux MINI RITI pasują również odbłyśniki Kanlux RITI REF.

Material obudowy: stop aluminium

Kanlux MINI RITI is a smaller, slightly lower version of the popular Kanlux RITI luminaire. We prepared it in two versions - black and white, but each of them has several reflector colours - white, black or gold. We are sure that such a wide choice ensures that Kanlux MINI RITI can more easily be adapted to the type of interior in which it is placed. If you want to go for extravagance, you can combine different colours of the luminaires or combine them with Kanlux RITI. Together, they will create a harmonious yet unusual room luminaire. Kanlux MINI RITI can also be combined with Kanlux RITI REF reflectors.

Enclosure material: aluminum alloy

Kanlux

MINI BORD

PIERŚCIEŃ OPRAWY PUNKTOWEJ ► RING FOR SPOTLIGHT FITTINGS



MINI BORD DLP-50-W

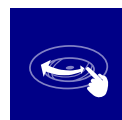

Mini wersja opraw Kanlux BORD. Doskonała alternatywa dla osób, które chcą stosować oprawy natynkowe na suficie podwieszanym, ponieważ sposób ich montażu jest taki sam jak w przypadku opraw wpuszczanych typu oczko. Dodatkowym atutem jest regulacja kątowa opraw MINI BORD w zakresie 30°.

Materiał obudowy: stop aluminium, stal

The Mini version of the BORD fixtures. A perfect alternative for people who want to use surface-mounted fixtures in a suspended ceiling, because the manner of installation is the same as for recessed-eyelet fixtures. An additional advantage is the angular adjustment of the MINI BORD fixtures within the range of 30°.

Enclosure material: aluminum alloy, steel



MINI BORD DLP-50-W	28782	5905339287823	max 35	biały white	w jednej osi in one axis	30
MINI BORD DLP-50-B	28783	5905339287830	max 35	czarny black	w jednej osi in one axis	30

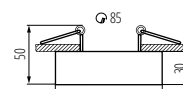

MINI BORD DLP-50

Kanlux

MINI GORD

PIERŚCIEŃ OPRAWY PUNKTOWEJ ► RING FOR SPOTLIGHT FITTINGS



MINI GORD DLP-50-W

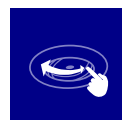

Mini wersja opraw Kanlux GORD. Doskonała alternatywa dla osób, które chcą stosować oprawy natynkowe na suficie podwieszanym, ponieważ sposób ich montażu jest taki sam jak w przypadku opraw wpuszczanych typu oczko. Dodatkowym atutem jest regulacja kątowa opraw MINI GORD w zakresie 30°.

Materiał obudowy: stop aluminium, stal

The Mini version of the GORD fixtures. A perfect alternative for people who want to use surface-mounted fixtures in a suspended ceiling, because the manner of installation is the same as for recessed-eyelet fixtures. An additional advantage is the angular adjustment of the MINI GORD fixtures within the range of 30°.

Enclosure material: aluminum alloy, steel



MINI GORD DLP-50-W	28780	5905339287809	max 35	biały white	w jednej osi in one axis	30
MINI GORD DLP-50-B	28781	5905339287816	max 35	czarny black	w jednej osi in one axis	30

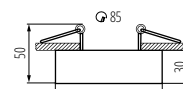

MINI GORD DLP-50



GOVIK DSO-W



KANLUX GOVIK to nowa oprawa do wbudowania o unikatowej konstrukcji. Zastosowanie matowego, akrylowego klosza rozprasza światło i powoduje, że zainstalowane źródło światła jest niewidoczne. Oprawa wygląda jak miniaturowy zintegrowany natynk.



Pierścieni dekoracyjny bez oprawki ceramicznej

Materiał obudowy: stop aluminium



KANLUX GOVIK is a new holder for building in with a unique structure. The mat, acrylic lampshade diffuses light and makes the installed light source be invisible. The holder looks like a miniature integrated surface mounted luminaire.

Decorative ring without a ceramic frame
Enclosure material: aluminum alloy



GOVIK DSO-B



GOVIK-ST DSO-B



GOVIK-ST DSO-W



GOVIK DSO-W	29235	5905339292353	max 10	biały white	brak none
GOVIK DSO-B	29236	5905339292360	max 10	czarny black	brak none
GOVIK-ST DSO-B	29237	5905339292377	max 10	czarny black	brak none
GOVIK-ST DSO-W	29238	5905339292384	max 10	biały white	brak none

[VI]	MR16/PAR16	6x5,3/GU10	IP 20
12 AC; 12 DC; 220-240 AC	5+25	Ø67	0,5m
House icon	Temperature icon	Beam angle icon	CE mark

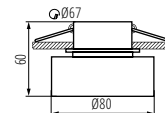

GOVIK DSO

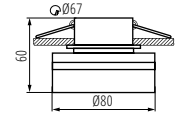

GOVIK-ST DSO

Kanlux AJAS

PIERŚCIEŃ OPRAWY PUNKTOWEJ ► RING FOR SPOTLIGHT FITTINGS

NEW



AJAS DSO-B



AJAS DSO-W

unique
LIGHT
effect



Kanlux AJAS to ciekawy model pierścienia dekoracyjnego. Wyróżnia się przede wszystkim nietypowym efektem świecenia. Dzięki obudowie składającej się z dwóch, połączonych ze sobą na stałe elementów, światło delikatnie oświetla również sufit. Oprawa Kanlux AJAS będzie wyjątkową ozdobą każdego pomieszczenia, zwłaszcza po włączeniu światła.

Materiał obudowy: stop aluminium, tworzywo sztuczne

Kanlux AJAS is an interesting model of a decorative ring. It is distinguished primarily by its unusual lighting effect. Thanks to a casing consisting of two permanently connected elements, the light also gently illuminates the ceiling. The Kanlux AJAS luminaire will constitute a unique decoration of any room, especially when the light is switched on.

Enclosure material: aluminum alloy, plastic



AJAS DSO-B	33160	5905339331601	max 10	czarny black	brak none
AJAS DSO-W	33161	5905339331618	max 10	biały white	brak none

IV					IP 20
12 AC; 12 DC; 220-240 AC	MR16/PAR16	5+25	Ø92	0,5m	

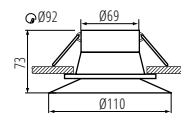

AJAS DSO

SIMEN DSO

PIERŚCIEŃ OPRAWY PUNKTOWEJ ► RING FOR SPOTLIGHT FITTINGS



SIMEN DSO SR/B



SIMEN DSO G/W



SIMEN DSO B/G



SIMEN DSO B/W



SIMEN DSO W/B



SIMEN DSO W/G



SIMEN DSO G/B



Kanlux SIMEN DSO to oprawa, która składa się z dwóch części: pierścienia i korpusu. Proponujemy stałe zestawy kolorystyczne, klasyczną czerni i biel lub oprawy zawierające srebrne i złote elementy, które dopasujesz do wnętrza, gdzie staną się one widoczną ozdobą. Możesz również samodzielnie wymieniać elementy z posiadanych zestawów opraw Kanlux SIMEN DSO.

Materiał obudowy: stop aluminium

Kanlux SIMEN DSO is a fixture which consists of two parts - ring, and body. Our range includes permanent colour sets in classic black and white, and fixtures with silver and gold elements, which will fit in with your interior, where they will become a visible decoration. You can also replace individual elements with other Kanlux SIMEN DSO fixture sets you already have.

Enclosure material: aluminum alloy



SIMEN DSO B/G	29137	5905339291370	max 35	czarny / złoty black/gold	brak none
SIMEN DSO B/W	29138	5905339291387	max 35	czarny / biały black/white	brak none
SIMEN DSO W/B	29139	5905339291394	max 35	biały / czarny white / black	brak none
SIMEN DSO W/G	29140	5905339291400	max 35	biały / złoty white / gold	brak none
SIMEN DSO G/B	29141	5905339291417	max 35	złoty / czarny gold / black	brak none
SIMEN DSO G/W	29142	5905339291424	max 35	złoty / biały gold / white	brak none
SIMEN DSO SR/B	29143	5905339291431	max 35	srebrny / czarny silver / black	brak none

VI						
12 AC; 12 DC; 220-240 AC	MR16/PAR16	5+25	Gx5,3/GU10	Ø68	0,5m	
IP 20						

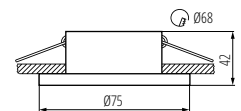

SIMEN DSO

SIMEN DSL

PIERŚCIEŃ OPRAWY PUNKTOWEJ ► RING FOR SPOTLIGHT FITTINGS



SIMEN DSL SR/B/B



SIMEN DSL W/W/B



SIMEN DSL B/W/B



SIMEN DSL W/W/G



SIMEN DSL B/G/B



SIMEN DSL W/G/W



SIMEN DSL B/B/G

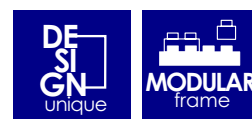

Kanlux SIMEN DSL to oprawa, która składa się z trzech części: pierścienia, korpusu i podstawy. Proponujemy gotowe zestawy kolorystyczne: klasyczną czerń i biel lub oprawy zawierające srebrne i złote elementy, które dopasujesz do wnętrza, gdzie staną się one widoczną ozdobą. Możesz również samodzielnie wymieniać elementy z posiadanych zestawów opraw Kanlux SIMEN DSL.

Materiał obudowy: stop aluminium

Kanlux SIMEN DSL is a fixture which consists of three parts - ring, body and base. Our range includes prepared colour sets in classic black and white, or fixtures with silver and gold elements, which will fit in with your interior, where they will become a visible decoration. You can also replace individual elements with other Kanlux SIMEN DSL fixture sets you already have.

Enclosure material: aluminum alloy



SIMEN DSL W/W/B	29130	5905339291301	max 35	biały / biały / czarny white / white / black	brak none
SIMEN DSL B/W/B	29131	5905339291318	max 35	czarny / biały / czarny black / white / black	brak none
SIMEN DSL SR/B/B	29132	5905339291325	max 35	srebrny / czarny / czarny silver / black / black	brak none
SIMEN DSL W/W/G	29133	5905339291332	max 35	biały / biały / złoty white / white / gold	brak none
SIMEN DSL B/G/B	29134	5905339291349	max 35	czarny / złoty / czarny black / gold / black	brak none
SIMEN DSL W/G/W	29135	5905339291356	max 35	biały / złoty / biały white / gold / white	brak none
SIMEN DSL B/B/G	29136	5905339291363	max 35	czarny / czarny / złoty black / black / gold	brak none

12 AC; 12 DC; 220-240 AC	MR16/PAR16	Gx5.3/GU10	0,5m	CE	Kanlux
IP 20	5+25	Ø68			

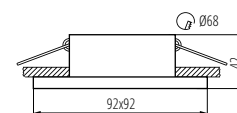

SIMEN DSL

CHIRO GU10



OPRAWA SUFITOWA PUNKTOWA ► CEILING-MOUNTED SPOTLIGHT FITTING



CHIRO GU10 DTO-B



CHIRO GU10 DTO-W



CHIRO GU10 DTL-W



CHIRO GU10 DTL-B



Kanlux CHIRO GU10, to coś zupełnie nowego w kategorii oświetlenia dekoracyjnego. To oprawa typu SPOT, którą można zamontować w podwieszanym suficie tak jak zwykłe oczko. Unikatowy design i montaż tej oprawy to jej największe atuty.

Materiał obudowy: stop aluminium

Kanlux CHIRO GU10, is a completely new category of decorative lighting. It is the ceiling-mounted lamp which can be mounted in a suspended ceiling just like an typical spotlight fitting. Unique design and assembly of this lamp are its largest assets.

Enclosure material: aluminum alloy



CHIRO GU10 DTO-W	29310	5905339293107	max 35	biały white	w jednej osi in one axis	90
CHIRO GU10 DTO-B	29311	5905339293114	max 35	czarny black	w jednej osi in one axis	90
CHIRO GU10 DTL-W	29312	5905339293121	max 35	biały white	w jednej osi in one axis	90
CHIRO GU10 DTL-B	29313	5905339293138	max 35	czarny black	w jednej osi in one axis	90

[V] 220-240 AC	[Hz] 50/60	PAR16	GU10	IP 20	CE	EAC	Kanlux
[°C] 5+25	[°] 340	[mm] Ø70	[mm] 0,75-1,5	[m] 0,5m	CE	EAC	Kanlux

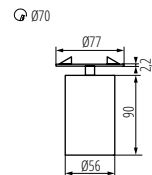

CHIRO GU10 DTO

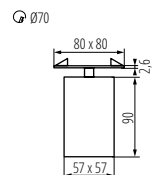

CHIRO GU10 DTL

Kanlux SPAG

PIERSIEŃ OPRAWY PUNKTOWEJ ► RING FOR SPOTLIGHT FITTINGS



SPAG C B-G



SPAG L B-G



SPAG S B-G



SPAG D B-G



SPAG L W-G



SPAG S W-G



SPAG C W-G



SPAG D W-G



Kanlux SPAG to eleganckie pierścienie ozdobne. Połączenie złota i klasycznej czerni lub bieli dodaje tym oprawom subtelny urok. Dzięki różnym kształtom opraw Kanlux SPAG możemy stworzyć niepowtarzalne i gustowne aranżacje oświetleniowe w naszych salonach, eleganckich restauracjach i apartamentach hotelowych.

Materiał obudowy: stop aluminium

Kanlux SPAG are elegant decorative rings. A combination of gold and classic black or white adds a subtle charm to these holders. Thanks to diverse shapes of the Kanlux SPAG holders, you can create unique and stylish lighting arrangements in your living rooms, elegant restaurants and hotel apartments.

Enclosure material: aluminum alloy

Model	Code	Part No.	Max. H.	Color	Material	Notes
SPAG L B/G	27320	5905339273208	max 35	czarny / złoty black/gold	brak none	
SPAG L W/G	27321	5905339273215	max 35	biały / złoty white / gold	brak none	
SPAG S B/G	27322	5905339273222	max 35	czarny / złoty black/gold	brak none	
SPAG S W/G	27323	5905339273239	max 35	biały / złoty white / gold	brak none	
SPAG C B/G	27324	5905339273246	max 35	czarny / złoty black/gold	brak none	
SPAG C W/G	27325	5905339273253	max 35	biały / złoty white / gold	brak none	
SPAG D B/G	27326	5905339273260	max 35	czarny / złoty black/gold	brak none	
SPAG D W/G	27327	5905339273277	max 35	biały / złoty white / gold	brak none	

12 AC; 12 DC; 220-240 AC	MR16/PAR16	6x5,3/GU10	5+25	Ø61-62	0,5m	CE	Kanlux
IP 20							

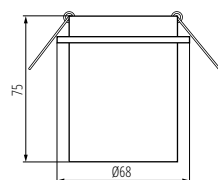

SPAG L

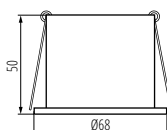

SPAG D

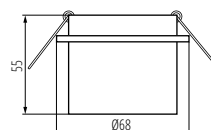

SPAG S

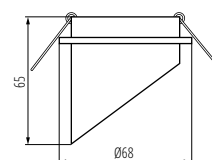

SPAG C

Kanlux LUNIO



PIERŚCIEŃ OPRAWY PUNKTOWEJ ► RING FOR SPOTLIGHT FITTINGS



LUNIO DTO-W



LUNIO DTO-W | 29230 | 5905339292308 max 35 biały | white

[V] 12 AC; 12 DC; 220-240 AC	MR16/PAR16	Gx5,3/GU10	IP 20	House icon
5÷25	35	350	112	0,5m



Kanlux LUNIO to nowy rodzaj oczka, który charakteryzuje się unikalnym wzorem. Podstawowe ustawienie oczka zapewnia padanie światła pod kątem 20-35 stopni, możemy jednak obracać podstawę z tubą o kąt 350 stopni. Tuba, w której zamontowane jest źródło, może się opierać o krawędź podstawy lub być cofnięta do wnętrza podstawy.

Pierścień dekoracyjny bez oprawki ceramicznej
Materiał obudowy: stop aluminium

Kanlux LUNIO is a new type of eye characterized by unique pattern. The basic setting of the eye ensures that light falls at the angle of 20-35 degrees, however you can turn the base with a tube by the angle of 350 degrees. The tube with the source can be based on the base edge or be moved back into the inside of the base.

Decorative ring without a ceramic frame
Enclosure material: aluminum alloy

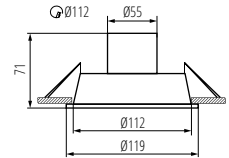

LUNIO DTO

Kanlux IMINES

PIERŚCIEŃ OPRAWY PUNKTOWEJ ► RING FOR SPOTLIGHT FITTINGS



IMINES DSL-W



IMINES DSL-W | 29030 | 5905339290304 max 35 biały mat | matte white brak | none
IMINES DSO-W | 29031 | 5905339290311 max 35 biały mat | matte white brak | none

[V] 12 AC; 12 DC; 220-240 AC	MR16/PAR16	Gx5,3/GU10	IP 20	House icon
5÷25	35	0,5m		



Kanlux IMINES to unikatowa oprawa, która posiada zaskakujący efekt świetlny - po włączeniu światła uzyskujemy dodatkowy, ozdobny pierścień świetlny.

Materiał obudowy: stop aluminium, tworzywo sztuczne

Kanlux IMINES is a unique fixture, which has a surprising light effect - when you turn on the light, you get an additional, decorative light ring.

Enclosure material: aluminum alloy, plastic

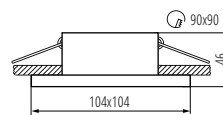

IMINES DSL

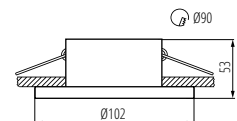

IMINES DSO

Kanlux BONIS

PIERŚCIEŃ OPRAWY PUNKTOWEJ ► RING FOR SPOTLIGHT FITTINGS



BONIS DSO-W



BONIS DSO-C



BONIS DSL-W



BONIS DSL-C



Kanlux BONIS to unikatowy wygląd i jakość wykonania na najwyższym poziomie. Charakteryzują się oryginalnym asymetrycznym kształtem, który doda smaku każdemu wnętrzu. W surowych loftach i oszczędnych skandynawskich wnętrzach będzie stanowiła ozdobę, w pomieszczeniach o ekskluzywnym charakterze podkreśli dyskretnie ich klimat.

Materiał obudowy: stop aluminium

The Kanlux BONIS means a unique look and the highest level of workmanship. They are characterised by their original asymmetrical shape, which will be a tasteful addition to any interior. They will serve as decoration in austere lofts and minimalist Scandinavian interiors, and discreetly emphasise the atmosphere of exclusive rooms.

Enclosure material: aluminum alloy

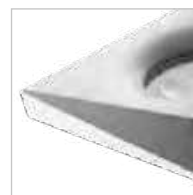

BONIS DSO-W	28700	5905339287007	max 35	biały white	brak none
BONIS DSO-C	28701	5905339287014	max 35	chrom chrome	brak none
BONIS DSL-W	28702	5905339287021	max 35	biały white	brak none
BONIS DSL-C	28703	5905339287038	max 35	chrom chrome	brak none

IV					
12 AC; 12 DC; 220-240 AC	MR16/PAR16	5+25	Ø70	0,5m	CE
IP 20					
					Kanlux

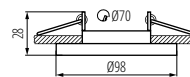

BONIS DSO

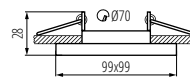

BONIS DSL

Kanlux

ELNIS S

PIERŚCIEŃ OPRAWY PUNKTOWEJ ► RING FOR SPOTLIGHT FITTINGS



ELNIS S W/A



ELNIS S W



ELNIS S W/A



ELNIS S A/C

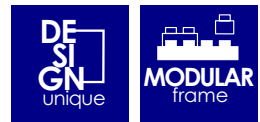

Kanlux Elnis to oprawa, która składa się z dwóch części tworzących całość. To kombinacja dwóch odrębnych elementów: korpusu (zasadniczej części) oraz obudowy (pierścienia dystansowego), tworzących idealnie dopasowaną całość. Wysokość obudowy Elnis S wynosi 10 mm. Kanlux Elnis cechuje nowoczesny wygląd i bardzo wysoka jakość wykonania.

Pierścień dekoracyjny bez oprawki ceramicznej

Materiał obudowy: stop aluminium

The Kanlux Elnis is a fixture which consists of two parts forming a whole. It is a combination of two separate elements: the body (the main part) and the casing (the spacer ring), forming a perfectly matched whole. Elnis S is a fixture with a 10-mm-high casing. The Kanlux Elnis is characterised by modern design and very-high quality of workmanship.

Decorative ring without a ceramic frame

Enclosure material: aluminum alloy



ELNIS S W	27800	5905339278005	max 35	biały white	brak none
ELNIS S W/A	27801	5905339278012	max 35	biały / antracyt white/anthracite	brak none
ELNIS S A/W	27802	5905339278029	max 35	antracyt / biały anthracite / white	brak none
ELNIS S A/C	27803	5905339278036	max 35	antracyt / chrom anthracite / chrome	brak none

VI						
12 AC; 12 DC; 220-240 AC	MR16/PAR16	Gx5,3/GU10	6x5,3/GU10	Ø70	0,5m	
IP 20						
	5÷25	Ø70	0,5m			

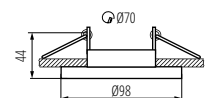

ELNIS S

ELNIS L

PIERŚCIEŃ OPRAWY PUNKTOWEJ ► RING FOR SPOTLIGHT FITTINGS



ELNIS L W/A



ELNIS L W



ELNIS L W/C



ELNIS L A/W



ELNIS L A/C



ELNIS L A



ELNIS L B/G



ELNIS L C/W



ELNIS L C/A

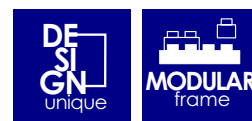

Kanlux Elnis L to oprawa, która składa się z dwóch części tworzących całość. To kombinacja dwóch odrębnych elementów: korpusu (zasadniczej części) oraz obudowy (pierścienia dystansowego), tworzących idealnie dopasowaną całość. Wysokość obudowy Elnis L wynosi 25 mm. Kanlux Elnis L cechuje nowoczesny wygląd i bardzo wysoka jakość wykonania.

Materiał obudowy: stop aluminium

The Kanlux Elnis L is a fixture which consists of two parts forming a whole. It is a combination of two separate elements: the body (the main part) and the casing (the spacer ring), forming a perfectly matched whole. The Elnis L is a fixture with a 25-mm-high casing. The Kanlux Elnis L is characterised by modern design and very-high quality of workmanship.

Enclosure material: aluminum alloy



ELNIS L W	27804	5905339278043	max 35	biały white	brak none
ELNIS L W/A	27805	5905339278050	max 35	biały / antracyt white/anthracite	brak none
ELNIS L W/C	27806	5905339278067	max 35	biały / chrom white / chrome	brak none
ELNIS L A/W	27807	5905339278074	max 35	antracyt / biały anthracite / white	brak none
ELNIS L A/C	27808	5905339278081	max 35	antracyt / chrom anthracite / chrome	brak none
ELNIS L A	27809	5905339278098	max 35	antracyt anthracite	brak none
ELNIS L B/G	27810	5905339278104	max 35	czarny / złoty black/gold	brak none
ELNIS L C/W	27811	5905339278111	max 35	chrom / biały chrome / white	brak none
ELNIS L C/A	27812	5905339278128	max 35	chrom / antracyt chrome / anthracite	brak none

IV	MRI16/PAR16	Gx5,3/GU10	0,5m	CE
12 AC; 12 DC; 220-240 AC	IP 20	5+25	Ø70	0,5m

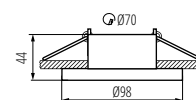

ELNIS L

Kanlux SEIDY

OPRAWA SUFITOWA PUNKTOWA ► CEILING-MOUNTED SPOTLIGHT FITTING



SEIDY CT-DT050-AL

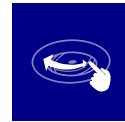

Kanlux SEIDY to popularna rodzina opraw, w której możemy wybrać od 1 do 4 punktów świetlnych. Skomponujemy z nich idealne oświetlenie kawiarni, wnętrz hotelowych, ale także zacisza domowego.

Materiał obudowy: stop aluminium

Kanlux SEIDY is a popular family of holders in which you can choose from 1 to 4 light points. You will compose ideal lighting of coffee shops, hotel interiors and privacy interiors of them.

Enclosure material: aluminum alloy



SEIDY CT-DT050-AL	18280	5905339182807	max 50	aluminium szczotkowane brushed aluminium	w jednej osi in one axis	30
SEIDY CT-DTL50-AL	18281	5905339182814	max 50	aluminium szczotkowane brushed aluminium	w jednej osi in one axis	30
SEIDY CT-DTL250-AL	18282	5905339182821	2 x max 50	aluminium szczotkowane brushed aluminium	w jednej osi in one axis	30
SEIDY CT-DTL250-B	18284	5905339182845	2 x max 50	czarny anodowany black anodised	w jednej osi in one axis	30
SEIDY CT-DT050-B	18288	5905339182883	max 50	czarny anodowany black anodised	w jednej osi in one axis	30
SEIDY CT-DTL50-B	18289	5905339182890	max 50	czarny anodowany black anodised	w jednej osi in one axis	30
SEIDY CT-DTL50-W/M	19454	5905339194541	max 50	biały mat matte white	w jednej osi in one axis	30
SEIDY CT-DTL250-W/M	19455	5905339194558	2 x max 50	biały mat matte white	w jednej osi in one axis	30

12 AC; 12 DC	MR-16	Gx5,3	III	4	IP 20	
5+25		0,12	0,75	0,5m		

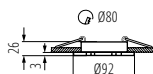
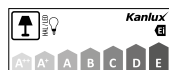

SEIDY CT-DT050

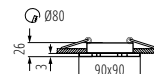

SEIDY CT-DTL50

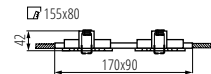

SEIDY CT-DTL250

Kanlux
SEIDY

OPRAWA SUFITOWA PUNKTOWA ► CEILING-MOUNTED SPOTLIGHT FITTING



SEIDY CT-DT050-AL



SEIDY CT-DTL50-AL



SEIDY CT-DTL250-AL



SEIDY CT-DT050-B



SEIDY CT-DTL50-B



SEIDY CT-DTL250-B



SEIDY CT-DTL50-W/M



SEIDY CT-DTL250-W/M



Kanlux DALLA

OPRAWA SUFITOWA PUNKTOWA ► CEILING-MOUNTED SPOTLIGHT FITTING



DALLA CT-DTL50-B



DALLA CT-DT050-W



DALLA CT-DTL50-W



DALLA CT-DT050-B



Kanlux DALLA to bardzo starannie wykonana oprawa do montażu wewnątrz. Posiada ruchomy pierścień przez co możemy regulować strumień światła. Jej kształty i uniwersalne kolory pozwalają na osiągnięcie nowoczesnego, dyskretnego efektu elegancji.

Materiał obudowy: stop aluminium

Kanlux DALLA is a very carefully made holder for installation inside. It has a movable ring, thanks to which you can adjust the light stream. Its shapes and universal colours allow achieving a modern, discrete effect of elegance.

Enclosure material: aluminum alloy



DALLA CT-DT050-W	22430	5905339224309	max 50	biały white	w jednej osi in one axis	30
DALLA CT-DTL50-W	22431	5905339224316	max 50	biały white	w jednej osi in one axis	30
DALLA CT-DT050-B	22432	5905339224323	max 50	czarny black	w jednej osi in one axis	30
DALLA CT-DTL50-B	22433	5905339224330	max 50	czarny black	w jednej osi in one axis	30

12 AC; 12 DC	MR-16	Gx5,3	IP 20		
5+25	Ø70	0,12	0,75		

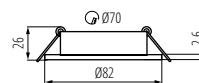

DALLA CT-DT050

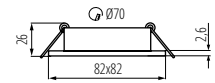

DALLA CT-DTL50

Kanlux MORTA

OPRAWA SUFITOWA PUNKTOWA ▶ CEILING-MOUNTED SPOTLIGHT FITTING



MORTA CT-DSL50-B



MORTA CT-DSL50-SR



MORTA CT-DSO50-B



MORTA CT-DSO50-SR



MORTA CT-DSL250-B



MORTA CT-DSL250-SR



Szeroka gama modeli opraw Kanlux MORTA pozwoli na realizowanie bardzo oryginalnych aranżacji w każdym domu. Kanlux MORTA spełnią oczekiwania wszystkich, którzy cenią sobie produkty wysokiej jakości, charakteryzujące się atrakcyjnym i oryginalnym designem.

Materiał obudowy: szkło

A wide range of the Kanlux MORTA holder models will allow making very original arrangements in each house. Kanlux MORTA meet expectations of everyone that highly values products of high quality, characterized by attractive and original design.

Enclosure material: glass



MORTA CT-DSL50-B	18510	5905339185105	max 50	czarny black	brak none
MORTA CT-DSL50-SR	18512	5905339185129	max 50	srebrny silver	brak none
MORTA CT-DSL250-B	19360	5905339193605	2 x max 50	czarny black	brak none
MORTA CT-DSL250-SR	19362	5905339193629	2 x max 50	srebrny silver	brak none
MORTA CT-DSO50-B	19440	5905339194404	max 50	czarny black	brak none
MORTA CT-DSO50-SR	19442	5905339194428	max 50	srebrny silver	brak none

12 AC; 12 DC	MR-16		Gx5,3	III	IP 20	

5-25	0,12	0,75	0,5m	CE	ENEC	Kanlux

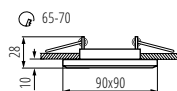

MORTA CT-DSL50

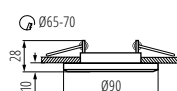

MORTA CT-DSO50

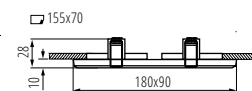

MORTA CT-DSL250

MORTA DT

PIERŚCIEŃ OPRAWY PUNKTOWEJ ► RING FOR SPOTLIGHT FITTINGS



MORTA CT-DTL50-B



MORTA CT-DT050-SR



MORTA CT-DT050-B



MORTA CT-DTL50-SR



Szeroka gama modeli opraw Kanlux MORTA pozwoli na zrealizowanie bardzo oryginalnych aranżacji w każdym domu. Kanlux MORTA spełniają oczekiwania wszystkich, którzy cenią sobie produkty wysokiej jakości, charakteryzujące się atrakcyjnym i oryginalnym designem.

Materiał obudowy: szkło

A wide range of the Kanlux MORTA holder models will allow making very original arrangements in each house. Kanlux MORTA meet expectations of everyone that highly values products of high quality, characterized by attractive and original design.

Enclosure material: glass



MORTA CT-DT050-SR	26716	5905339267160	max 35	srebrny silver	w jednej osi in one axis	30
MORTA CT-DT050-B	26717	5905339267177	max 35	czarny black	w jednej osi in one axis	30
MORTA CT-DTL50-SR	26718	5905339267184	max 35	srebrny silver	w jednej osi in one axis	30
MORTA CT-DTL50-B	26719	5905339267191	max 35	czarny black	w jednej osi in one axis	30

12 AC; 12 DC; 220-240 AC	MR16/PAR16	5~25	Ø75-80	0,5m	CE
IP 20					

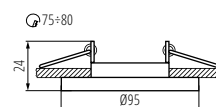

MORTA CT-DT050-SR

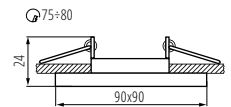

MORTA CT-DTL50

MORTA B

OPRAWA SUFITOWA PUNKTOWA ▶ CEILING-MOUNTED SPOTLIGHT FITTING



MORTA B CT-DSL50-B



MORTA B CT-DSL50-SR



MORTA B CT-DSO50-B



MORTA B CT-DSO50-SR



Szeroka gama modeli opraw Kanlux MORTA pozwoli na zrealizowanie bardzo oryginalnych aranżacji w każdym domu. Kanlux MORTA spełnią oczekiwania wszystkich, którzy cenią sobie produkty wysokiej jakości, charakteryzujące się atrakcyjnym i oryginalnym designem.

Materiał obudowy: szkło

A wide range of the Kanlux MORTA holder models will allow making very original arrangements in each house. Kanlux MORTA meet expectations of everyone that highly values products of high quality, characterized by attractive and original design.

Enclosure material: glass

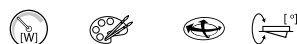

MORTA B CT-DSL50-B	22110	5905339221100	max 50	czarny black	brak none
MORTA B CT-DSL50-SR	22112	5905339221124	max 50	srebrny silver	brak none
MORTA B CT-DSO50-B	22116	5905339221162	max 50	czarny black	brak none
MORTA B CT-DSO50-SR	22117	5905339221179	max 50	srebrny silver	brak none

[V] 12 AC; 12 DC	 MR-16	 Gx5,3	 IP 20	 EAC
 5÷25	 Ø65-70	 0,12	 0,75	 0,5m

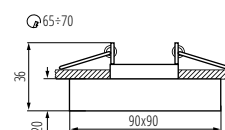

MORTA B CT-DSL50

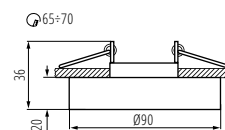

MORTA B CT-DSO50

Kanlux

MORTA OCT

PIERŚCIEŃ OPRAWY PUNKTOWEJ ► RING FOR SPOTLIGHT FITTINGS



Szeroka gama modeli opraw Kanlux MORTA pozwoli na zrealizowanie bardzo oryginalnych aranżacji w każdym domu. Kanlux MORTA spełnia oczekiwania wszystkich, którzy cenią sobie produkty wysokiej jakości, charakteryzujące się atrakcyjnym i oryginalnym designem.

Materiał obudowy: szkło

A wide range of the Kanlux MORTA holder models will allow making very original arrangements in each house. Kanlux MORTA meet expectations of everyone that highly values products of high quality, characterized by attractive and original design.

Enclosure material: glass



MORTA OCT-SR

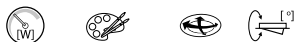

MORTA OCT-SR	26714	5905339267146	max 35	srebrny silver	brak	none
MORTA OCT-B	26715	5905339267153	max 35	czarny black	brak	none

[V] 12 AC; 12 DC; 220-240 AC	MR16/PAR16	MR16/PAR16	Gx5,3/GU10	Ø60-65	0,5m	CE	
IP 20	5+25	Ø60-65	0,5m	CE			

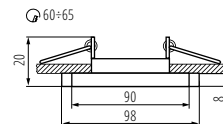

MORTA OCT

Kanlux

APRILA

PIERŚCIEŃ OPRAWY PUNKTOWEJ ► RING FOR SPOTLIGHT FITTINGS

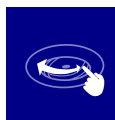

Kanlux APRILA to rodzina białych pierścieni dekoracyjnych wykonanych z aluminium. Kanlux APRILA ma opływowy kształt i możliwość regulacji kąta padania światła w zakresie 20 stopni. W opraw możemy zastosować oprawkę GU10 lub Gx5,3, co pozwoli nam na zastosowanie źródeł światła dopasowanych do przygotowanej instalacji.

Pierścień dekoracyjny bez oprawki ceramicznej

Materiał obudowy: stop aluminium

Kanlux APRILA is a family of white decorative rings made of aluminium. Kanlux APRILA has a streamlined shape and can be adjusted in terms of the angle of light within the range of 20 degrees. The JDR or MR-16 frame can be used for the holders, which will allow us to use light sources adapted to a prepared installation.

Decorative ring without a ceramic frame

Enclosure material: aluminum alloy



APRILA DTO-W



APRILA DTO-W	26738	5905339267382	max 35	biały mat matte white	w jednej osi in one axis	20
APRILA DTL-W	26739	5905339267399	max 35	biały mat matte white	w jednej osi in one axis	20

[V] 12 AC; 12 DC; 220-240 AC	MR16/PAR16	MR16/PAR16	Gx5,3/GU10	Ø90	0,5m	CE	
IP 20	5+25	Ø90	0,5m	CE			

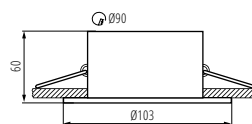

APRILA DTO

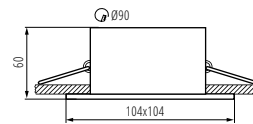

APRILA DTL

Kanlux SOREN

OPRAWA SUFITOWA PUNKTOWA ▶ CEILING-MOUNTED SPOTLIGHT FITTING



SOREN O-SR WW



SOREN O-BL



SOREN O-SR CW



SOREN L-SR WW



SOREN L-BL



SOREN L-SR CW



Kanlux SOREN to szklane oprawy, których dodatkowym atutem jest kolorowy, dekoracyjny pasek LED rozświetlający szklaną podstawę oprawy.

Materiał obudowy: szkło

Kanlux SOREN are glass holders whose additional asset is the colourful, decorative LED strip lighting up the glass base of the holder.

Enclosure material: glass



SOREN O-SR WW	24410	5905339244109	max 20	srebrny silver	ciepłobiała Warm white	brak none
SOREN O-BL	24411	5905339244116	max 20	srebrny silver	niebieska blue	brak none
SOREN L-SR WW	24413	5905339244130	max 20	srebrny silver	ciepłobiała Warm white	brak none
SOREN L-BL	24414	5905339244147	max 20	srebrny silver	niebieska blue	brak none
SOREN O-SR CW	24416	5905339244161	max 20	srebrny silver	chłodnobiała cold white	brak none
SOREN L-SR CW	24417	5905339244178	max 20	srebrny silver	chłodnobiała cold white	brak none

[V] 220-240 AC	[Hz] 50/60	LED 3,6	PAR16	GU10	SMD	≥15000	20000
IP 20	5+25	0,75+2,5	0,5m	CE	ERAC		

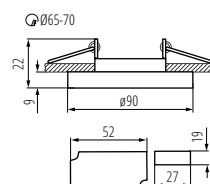

SOREN O

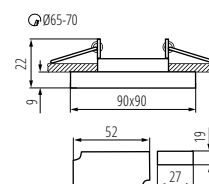

SOREN L

Kanlux

IVRI

PIERŚCIEŃ OPRAWY PUNKTOWEJ ► RING FOR SPOTLIGHT FITTINGS



IVRI DTO-W

Kanlux IVRI to rodzina pierścieni dekoracyjnych wykonanych z aluminium. Kanlux IVRI jest wyrazisty w swoim kształcie, a regulacja kierunku świecenia źródła światła wynosi 30 stopni.

Materiał obudowy: stop aluminium

Kanlux IVRI is a family of decorative rings made of aluminium. Kanlux IVRI is expressive in its shape and adjustment of the direction of light - light source comes to 30 degrees.

Enclosure material: aluminum alloy

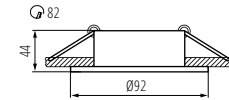

IVRI DTO



IVRI DTO-W | 26736 | 5905339267368 max 35 biały | white w jednej osi | in one axis 30



Kanlux

CEMIN

PIERŚCIEŃ OPRAWY PUNKTOWEJ ► RING FOR SPOTLIGHT FITTINGS



CEMIN DTL-GR

Kanlux CEMIN to oprawa wykonana z masy betonopodobnej z możliwością regulacji kierunku świecenia. Surowe, naturalne oprawy mają charakter industrialny i doskonale sprawdzą się w aranżacji wnętrz w stylu industrialnym oraz loftowym.

Materiał obudowy: beton

Kanlux CEMIN is a holder made of mass similar to concrete with a possibility of adjusting the direction of light. Raw, natural holders have industrial character and are perfect in arrangement of interiors in the industrial and loft-like style.

Enclosure material: concrete



CEMIN DTL-GR | 27230 | 5905339272300 max 35 szary | grey w jednej osi | in one axis 30

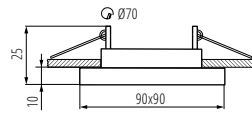

CEMIN DTL-GR

Kanlux

CEL

OPRAWA SUFITOWA PUNKTOWA ► CEILING-MOUNTED SPOTLIGHT FITTING



CEL CTC-5519-C/M

Kanlux CEL to oczko sufitowe wykonane z aluminium w kolorze matowego chromu. Oczko współpracuje z żarówkami o trzonku Gx4.

Materiał obudowy: stal

Kanlux CEL is a ceiling eye made of aluminium in the colour of mat chromium. The eye cooperates with bulbs with Gx4 light bulb base.

Enclosure material: steel



CEL CTC-5519-C/M | 02755 | 5905339027559 max 35 chrom satynowy | chrome Satin w jednej osi | in one axis 15

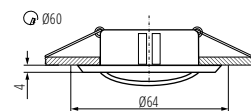

CEL CTC-5519-C/M



Kanlux ARET

PIERŚCIEŃ OPRAWY PUNKTOWEJ ► RING FOR SPOTLIGHT FITTINGS



ARET 1XMR16-W



ARET 1XMR16-GR



ARET 2XMR16-W



Rodzina opraw Kanlux ARET to pierścienie ozdobne wykonane ze stopu aluminium oraz blachy stalowej. Oczka te są bez oprawki – sami decydujemy czy dodamy do niego oprawkę GX10 czy GX5.3. Pozwala nam to dopasować źródła światła do instalacji, którą mamy w danym pomieszczeniu. Kanlux ARET sprawdzą się jako oświetlenie pomocnicze, zarówno w domach, barach jak i w restauracjach, wszędzie tam gdzie chcemy zaakcentować ciekawą aranżację pomieszczenia lub wyeksponować jego fragment.

Pierścieni dekoracyjny bez oprawki ceramicznej
Materiał obudowy: stop aluminium

A family of the Kanlux ARET holders are decorative rings made of aluminium alloy and steel metal sheet. These eyes are without a frame - you decide on your own whether to add the GX10 or GX5.3 frame to it. It allows adapting the light source to an installation available in a given room. Kanlux ARET works well as additional lighting both at homes, in bars and in restaurants, in places where you want to emphasize an interesting arrangement of a room or to display its fragment.

Decorative ring without a ceramic frame
Enclosure material: aluminum alloy



ARET 1XMR16-W	26720	5905339267207	max 35	biały white	w jednej osi in one axis	20
ARET 1XMR16-GR	26721	5905339267214	max 35	szary grey	w jednej osi in one axis	20
ARET 2XMR16-W	26723	5905339267238	2 x max 35	biały white	w jednej osi in one axis	20

IV					
12 AC; 12 DC; 220-240 AC	MR16/PAR16	5+25	0,5m	CE	
IP 20					

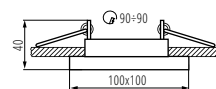

ARET 1XMR16

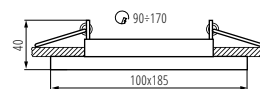

ARET 2XMR16

Kanlux MERIL

OPRAWA SUFITOWA PUNKTOWA ► CEILING-MOUNTED SPOTLIGHT FITTING



MERIL DLP-50-W



Kanlux MERIL to oprawy typu downlight z wymiennym źródłem światła. Oprawy dostępne są w wersji jedno i dwupunktowej, a ich istotną cechą jest możliwość swobodnej regulacji kątowej.

Materiał obudowy: stal

Kanlux MERIL are holders of downlight type with a replaceable source of light. The holders are available in one-spot beam and two-spot beam version and their significant feature is a possibility of free adjustment of the angle.

Enclosure material: steel



MERIL DLP-50-W	26480	5905339264800	max 35	biały white	w dwóch osiach in two axes	30/30
MERIL DLP-250-W	26481	5905339264817	2 x max 35	biały white	w dwóch osiach in two axes	30/30

[V] 220-240 AC	PAR16	GU10	IP 20	CE	ERC	Kanlux	
5+25	1+2,5	0,5m	A	B	C	D	E

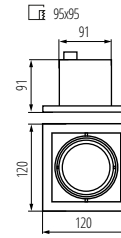

MERIL DLP-50

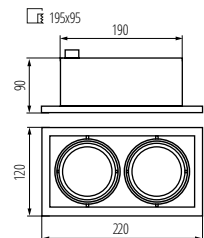

MERIL DLP-250

Kanlux ALREN R

PIERŚCIEŃ OPRAWY PUNKTOWEJ ► RING FOR SPOTLIGHT FITTINGS



ALREN R DTL-W



Model pierścieni dekoracyjnych Kanlux ALREN R to ciekawy, niespotykany na rynku kształt opraw - oczka z zaokrąglonymi narożnikami. Możliwość regulacji o 60 stopni w dwóch płaszczyznach to ich niewątpliwa zaleta. Kanlux ALREN R oferowane są bez oprawki.

Pierścień dekoracyjny bez oprawki ceramicznej

Materiał obudowy: stop aluminium

Kanlux ALREN R decorative rings have an interesting shape of fixtures never before seen on the market - eyelets with rounded corners. The possibility of 60-degree adjustment in two planes is an unquestionable advantage. The Kanlux ALREN R is supplied without a socket.

Decorative ring without a ceramic frame

Enclosure material: aluminum alloy



ALREN R DTL-B	26757	5905339267573	max 35	czarny black	w dwóch osiach in two axes	60/60
ALREN R DTL-W	26758	5905339267580	max 35	biały white	w dwóch osiach in two axes	60/60

[V] 12 AC; 12 DC; 220-240 AC	MR16/PAR16	Gx5,3/GU10	IP 20	CE	ERC	Kanlux	
5+25	60	80x80	A	B	C	D	E

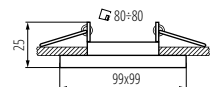

ALREN R DTL

ALREN

PIERŚCIEŃ OPRAWY PUNKTOWEJ ► RING FOR SPOTLIGHT FITTINGS



ARLEN DTL-W



ARLEN DTL-B



ARLEN DTL-C



ARLEN DTL-C/M



Pierścienie dekoracyjne Kanlux ALREN oferowane są bez oprawki – sami decydujemy czy dodamy do niego oprawkę GU10 czy GX5.3. Oprawy do wbudowania w sufit świetnie sprawdzają się jako oświetlenie pomocnicze w domach, barach, restauracjach, wszędzie tam gdzie chcemy zaakcentować aranżację pomieszczenia lub wyeksponować jego fragment.

Pierścień dekoracyjny bez oprawki ceramicznej

Materiał obudowy: stop aluminium

The Kanlux ALREN decorative rings are offered without a frame - you decide on your own whether to add the GU10 or GX5.3 frame to it. The holders for building in a ceiling work well as additional lighting at homes, in bars and in restaurants, in places where you want to emphasize an arrangement of a room or to display its fragment.

Decorative ring without a ceramic frame

Enclosure material: aluminum alloy



ALREN DTL-W	26753	5905339267535	max 35	biały mat matte white	w jednej osi in one axis	15
ALREN DTL-B	26754	5905339267542	max 35	czarny mat black matt	w jednej osi in one axis	15
ALREN DTL-C	26755	5905339267559	max 35	chrom chrome	w jednej osi in one axis	15
ALREN DTL-C/M	26756	5905339267566	max 35	chrom mat chrome matte	w jednej osi in one axis	15

IV					
12 AC; 12 DC; 220-240 AC	MR16/PAR16	5+25	6x5.3/GU10	83x83	0,5m
IP 20					

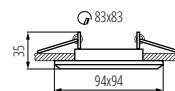

ARLEN DTL

Kanlux COLIE

PIERŚCIEŃ OPRAWY PUNKTOWEJ ► RING FOR SPOTLIGHT FITTINGS



COLIE DTO-G



COLIE DTO-W



COLIE DTO-AL



COLIE DTO-B



COLIE DTO-GR



Ozdobne pierścienie Kanlux COLIE pozwolą na zrealizowanie bardzo oryginalnych aranżacji w każdym domu. Charakteryzują się eleganckim i oryginalnym wzornictwem, zapewniając przy tym dyskretny rozsył światła. Seria COLIE przeznaczona jest do wbudowania w sufit. Znakomicie sprawdzają się jako oświetlenie pomocnicze, zarówno w domach, w barach jak i restauracjach, wszędzie tam gdzie chcemy zaakcentować ciekawą aranżację pomieszczenia.

Materiał obudowy: stop aluminium

The Kanlux COLIE decorative rings will allow making very original arrangements in each house. They are characterized by elegant and original design ensuring, at the same time, discrete distribution of light. The COLIE series is intended for building in a ceiling. They work well as additional lighting both at homes, in bars and in restaurants, in places where you want to emphasize an interesting arrangement of a room.

Enclosure material: aluminum alloy



Model	Code	Part No.	Max H	Finish	Beam	Height
COLIE DTO-W	26740	5905339267405	max 35	biały mat matte white	w jednej osi in one axis	15
COLIE DTO-G	26741	5905339267412	max 35	złoty anodowany gold anodised	w jednej osi in one axis	15
COLIE DTO-AL	26742	5905339267429	max 35	aluminium	w jednej osi in one axis	15
COLIE DTO-B	26743	5905339267436	max 35	czarny mat black matt	w jednej osi in one axis	15
COLIE DTO-GR	26744	5905339267443	max 35	szary grey	w jednej osi in one axis	15

12 AC; 12 DC; 220-240 AC	MR16/PAR16	6x5,3/GU10	0,5m	CE
IP 20	5±25	Ø75		

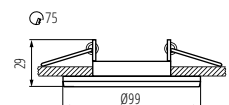

COLIE DTO



NESTA DSL-W



NESTA DTL-B



NESTA DTL-C



NESTA DTL-C/M



NESTA DSL-B



NESTA DSL-C



NESTA DSL-C/M



NESTA DTL-W

Oczka Kanlux NESTA dostępne są w wersji z ruchomym pierścieniem, pozwalającym na ukierunkowanie światła w daną stronę oraz z pierścieniem nieruchomym. Oprawy przeznaczone do wbudowania w sufit świetnie sprawdzają się jako oświetlenie pomocnicze, zarówno w domach, kawiarniach, restauracjach - wszędzie tam gdzie chcemy zaakcentować ciekawą aranżację pomieszczenia. Zestawiane w grupę oprawy te mogą również z powodzeniem pełnić funkcję oświetlenia głównego.

Materiał obudowy: stop aluminium

The Kanlux NESTA eyes are available in a version with a movable ring, allowing to direct light into a given side and with an immovable ring. The holders intended for building in a ceiling work well as additional lighting both at homes, in coffee shops and in restaurants, in places where you want to emphasize an interesting arrangement of a room. These holders combined in a group can also successfully perform the function of main light.

Enclosure material: aluminum alloy



NESTA DSL-W	26745	5905339267450	max 35	biały mat matte white	brak none	
NESTA DSL-B	26746	5905339267467	max 35	czarny mat black matt	brak none	
NESTA DSL-C	26747	5905339267474	max 35	chrom chrome	brak none	
NESTA DSL-C/M	26748	5905339267481	max 35	chrom mat chrome matte	brak none	
NESTA DTL-W	26749	5905339267498	max 35	biały mat matte white	w jednej osi in one axis	30
NESTA DTL-B	26750	5905339267504	max 35	czarny mat black matt	w jednej osi in one axis	30
NESTA DTL-C	26751	5905339267511	max 35	chrom chrome	w jednej osi in one axis	30
NESTA DTL-C/M	26752	5905339267528	max 35	chrom mat chrome matte	w jednej osi in one axis	30

IV	MR16/PAR16	GU5.3/GU10	0,5m	CE
12 AC; 12 DC; 220-240 AC				
IP 20	5=25			

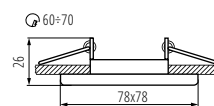

NESTA DSL

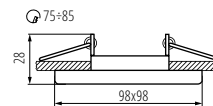

NESTA DTL

Kanlux EVIT

OPRAWA SUFITOWA PUNKTOWA ► CEILING-MOUNTED SPOTLIGHT FITTING



EVIT CT-DT050-AL



EVIT CT-DTL50-AL	18560	5905339185600	max 50	aluminium	w jednej osi in one axis	30
EVIT CT-DT050-AL	18561	5905339185617	max 50	aluminium	w jednej osi in one axis	30

[VI] 12 AC; 12 DC	MR-16	Gx5,3	III	IP 20	5+25	Ø70-75	0,12	0,75	0,5m	CE	ERAC
-----------------------------	-------	-------	-----	-------	------	--------	------	------	------	----	------

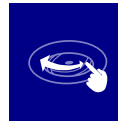
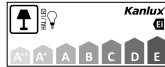

Kanlux EVIT to oprawa punktowa wykonana z aluminium. Posiada możliwość regulacji kierunku padania światła. Kanlux EVIT jest klasycznym oczkiem bez ozdóbek.

Materiał obudowy: stop aluminium

Kanlux EVIT is a spot-beam holder made of aluminium. It has a possibility of adjusting the direction of light. Kanlux EVIT is a classic eye without ornaments.

Enclosure material: aluminum alloy

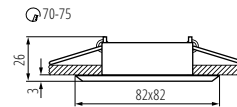

EVIT CT-DTL50

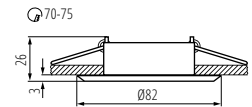

EVIT CT-DT050

Kanlux GWEN

OPRAWA SUFITOWA PUNKTOWA ► CEILING-MOUNTED SPOTLIGHT FITTING



GWEN CT-DT050-B



GWEN CT-DTL50-B	18530	5905339185303	max 50	czarny anodowany black anodised	w jednej osi in one axis	30
GWEN CT-DT050-B	18531	5905339185310	max 50	czarny anodowany black anodised	w jednej osi in one axis	30

[VI] 12 AC; 12 DC	MR-16	Gx5,3	III	IP 20	5+25	Ø70-75	0,12	0,75	0,5m	CE	ERAC
-----------------------------	-------	-------	-----	-------	------	--------	------	------	------	----	------

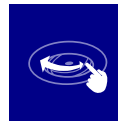

Kanlux GWEN to oczko, które idealnie pasuje do wnętrz eleganckich, stonowanych. Szczotkowane aluminium w czarnym kolorze doda szyku oświetlanemu wnętrzu.

Materiał obudowy: stop aluminium

Kanlux GWEN is an eye which perfectly fits into elegant, discreet interiors. Brushed aluminium in black colour will add stylishness to lighted interior.

Enclosure material: aluminum alloy

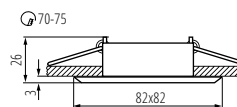

GWEN CT-DTL50

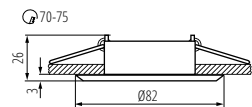

GWEN CT-DT050

Kanlux VIDI

OPRAWA SUFITOWA PUNKTOWA ► CEILING-MOUNTED SPOTLIGHT FITTING



VIDI CTC-5514-AN



VIDI CTC-5515-W



VIDI CTC-5515-C



VIDI CTC-5515-C/M



VIDI CTC-5515-B



VIDI CTC-5514-W



VIDI CTC-5514-C



VIDI CTC-5514-C/M



VIDI CTC-5514-B



VIDI CTC-5515-AN

Kanlux VIDI to rodzina prostych w swojej formie, różnorodnych opraw punktowych. Możemy komponować z nich różnorodne zestawy oświetleniowe wybierając wśród wielu kolorów tych aluminiowych opraw.

Materiał obudowy: stop aluminium

Kanlux VIDI is a family of simple in their form, diverse spot-beam holders. You can compose diverse lighting sets of them, choosing from among many colours of these aluminium holders.

Enclosure material: aluminum alloy



VIDI CTC-5515-W	02780	5905339027801	max 50	biały white	w jednej osi in one axis	15
VIDI CTC-5515-C	02781	5905339027818	max 50	chrom chrome	w jednej osi in one axis	15
VIDI CTC-5515-C/M	02783	5905339027832	max 50	chrom mat chrome matte	w jednej osi in one axis	15
VIDI CTC-5515-AN	02785	5905339027856	max 50	miedź matowa matte copper	w jednej osi in one axis	15
VIDI CTC-5514-W	02790	5905339027900	max 50	biały white	brak none	
VIDI CTC-5514-C	02791	5905339027917	max 50	chrom chrome	brak none	
VIDI CTC-5514-C/M	02793	5905339027931	max 50	chrom mat chrome matte	brak none	
VIDI CTC-5514-AN	02795	5905339027955	max 50	miedź matowa matte copper	brak none	
VIDI CTC-5514-B	25995	5905339259950	max 50	czarny mat black matt	brak none	
VIDI CTC-5515-B	25996	5905339259967	max 50	czarny mat black matt	w jednej osi in one axis	15

IV	MR-16	Gx5,3	IP 20	12 AC; 12 DC
5÷25	0,12	0,75	0,5m	CE EAC

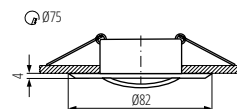

VIDI CTC-5515

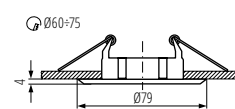

VIDI CTC-5514



NAVI CTX-DT10-W



NAVI CTX-DT10-C



NAVI CTX-DT10-C/M



NAVI CTX-DT10-AB



NAVI CTX-DT10-B



NAVI CTX-DS10-AB



NAVI CTX-DS10-C



NAVI CTX-DS10-SN



NAVI CTX-DS10-B

Kanlux NAVI to rodzina prostych w swojej formie, różnorodnych opraw punktowych o bardzo szerokich możliwościach zastosowania.

Materiał obudowy: stop aluminium

Kanlux NAVI is a family of simple in their form, diverse spot-beam holders with very broad possibilities of use.

Enclosure material: aluminum alloy



NAVI CTX-DT10-W	02550	5905339025500	max 50	biały white	w jednej osi in one axis	15
NAVI CTX-DT10-C	02551	5905339025517	max 50	chrom chrome	w jednej osi in one axis	15
NAVI CTX-DT10-C/M	02553	5905339025531	max 50	chrom mat chrome matte	w jednej osi in one axis	15
NAVI CTX-DT10-AB	02554	5905339025548	max 50	mosiądz matowy matt brass	w jednej osi in one axis	15
NAVI CTX-DS10-AB	04693	5905339046932	max 50	mosiądz matowy matt brass	brak none	
NAVI CTX-DS10-C	04694	5905339046949	max 50	chrom chrome	brak none	
NAVI CTX-DS10-SN	04695	5905339046956	max 50	nikiel mat nickel matte	brak none	
NAVI CTX-DS10-B	25990	5905339259905	max 50	czarny mat black matt	brak none	
NAVI CTX-DT10-B	25991	5905339259912	max 50	czarny mat black matt	w jednej osi in one axis	15

12 AC; 12 DC	MR-16	Gx5,3	0,12	0,75	0,5m	IP 20	
5+25							

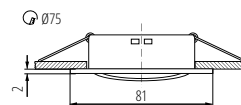

NAVI CTX-DT10

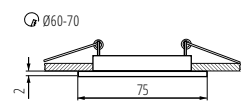

NAVI CTX-DS10

Kanlux LUTO

OPRAWA SUFITOWA PUNKTOWA ► CEILING-MOUNTED SPOTLIGHT FITTING



LUTO CTX-DS02B-C



LUTO CTX-DS02B-W



LUTO CTX-DS02B-AB



LUTO CTX-DS02B-C/M



LUTO CTX-DT02B-W



LUTO CTX-DT02B-C



LUTO CTX-DT02B-C/M



LUTO CTX-DT02B-AB

Kanlux LUTO to linia klasycznych oczek w stonowanych kolorach. Białe, patynowany mosiądz czy matowy chrom dyskretnie dodadzą uroku nie tylko przestrzeni domowej, ale również hotelom i kawiarniom.

Materiał obudowy: stop aluminium

Kanlux LUTO is a line of classic eyes in discreet colours. The white, patina brass or matt chromium will discretely add charm to a home space as well as to hotels and coffee shops.

Enclosure material: aluminum alloy



LUTO CTX-DS02B-W	02580	5905339025807	max 50	biały white	brak none
LUTO CTX-DS02B-C	02581	5905339025814	max 50	biały white	brak none
LUTO CTX-DS02B-C/M	02583	5905339025838	max 50	chrom mat chrome matte	brak none
LUTO CTX-DS02B-AB	02584	5905339025845	max 50	mosiądz matowy matt brass	brak none
LUTO CTX-DT02B-W	02590	5905339025906	max 50	biały white	w jednej osi in one axis 15
LUTO CTX-DT02B-C	02591	5905339025913	max 50	chrom chrome	w jednej osi in one axis 15
LUTO CTX-DT02B-C/M	02593	5905339025937	max 50	chrom mat chrome matte	w jednej osi in one axis 15
LUTO CTX-DT02B-AB	02594	5905339025944	max 50	mosiądz matowy matt brass	w jednej osi in one axis 15

IV	MR-16	Gx5,3	IP 20	5÷25	0,12	0,75	0,5m	CE	EAC	Kanlux
12 AC; 12 DC	MR-16	Gx5,3	IP 20	5÷25	0,12	0,75	0,5m	CE	EAC	Kanlux

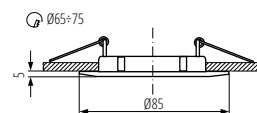

LUTO CTX-DS02B

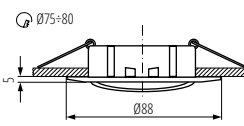

LUTO CTX-DT02B

Kanlux RADAN

OPRAWA SUFITOWA PUNKTOWA ► CEILING-MOUNTED SPOTLIGHT FITTING



RADAN CT-DT050

Kanlux RADAN to proste oczka, które rozjaśnią każde pomieszczenie. Sami wybierzemy źródło światła jak i wersję oprawy - z regulacją lub nieruchomą.

Materiał obudowy: stop aluminium

Kanlux RADAN are simple eyes which will light up each room. You can choose a source of light and a version of the holder on your own - with adjustment or immovable.

Enclosure material: aluminum alloy



RADAN CT-DTL50



RADAN CT-DSO50



RADAN CT-DSL50



RADAN CT-DT050	07360	5905339073600	max 50	aluminium	w jednej osi in one axis	30
RADAN CT-DTL50	07361	5905339073617	max 50	aluminium	w jednej osi in one axis	30
RADAN CT-DSO50	07362	5905339073624	max 50	aluminium	brak none	
RADAN CT-DSL50	07363	5905339073631	max 50	aluminium	brak none	

12 AC; 12 DC	MR-16	Gx5,3	III	IP 20	
5+25		0,12	0,75	0,5m	

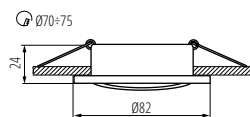

RADAN CT-DT0

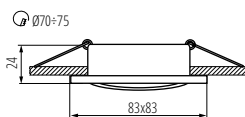

RADAN CT-DTL

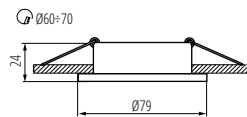

RADAN CT-DSO

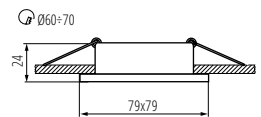

RADAN CT-DSL



TESON AL-DTL50

Kanlux TESON to proste oczka, które rozjaśnią każde pomieszczenie. Sami wybierzesz źródło światła jak i wersję oprawy - z regulacją lub nieruchomą.

Materiał obudowy: stop aluminium

Kanlux TESON are simple eyes which will light up each room. You can choose a source of light and a version of the holder on your own - with adjustment or immovable.

Enclosure material: aluminum alloy



TESON AL-DTL50



TESON AL-DSO50



TESON AL-DSL50

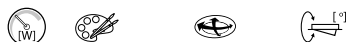

TESONAL-DTO50	07370	5905339073709	max 50	aluminium	w jednej osi in one axis	30
TESONAL-DTL50	07371	5905339073716	max 50	aluminium	w jednej osi in one axis	30
TESONAL-DSO50	07372	5905339073723	max 50	aluminium	brak none	
TESONAL-DSL50	07373	5905339073730	max 50	aluminium	brak none	

[V] 220-240 AC	[Hz] 50/60	PAR16	GU10	IP 20
5+25	0,75x2,5	0,5m	CE ENEC	Kanlux

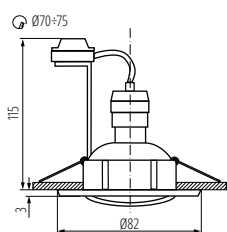

TESON AL-DTO

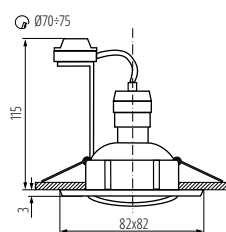

TESON AL-DTL

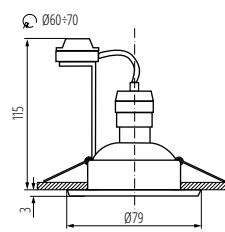

TESON AL-DSO

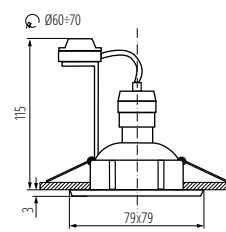

TESON AL-DSL

FLINI IP44

PIERŚCIEŃ OPRAWY PUNKTOWEJ ▶ RING FOR SPOTLIGHT FITTINGS



FLINI IP44 DSL-B



FLINI IP44 DSL-W



FLINI IP44 DSO-B



FLINI IP44 DSO-W



Kanlux FLINI to oprawy sufitowe dedykowane do łazienek i pomieszczeń o podwyższonej wilgotności. Dzięki swojej konstrukcji są one odporne na wilgoć (IP44). Kanlux FLINI dostępne są w dwóch kształtach - okrągłym i kwadratowym. Do wyboru mamy oprawę w kolorze białym matowym lub czarnym matowym. Dwie tak uniwersalne barwy pozwolą nam dopasować te lampy do każdego niemal wnętrza.

Materiał obudowy: stop aluminium

Kanlux FLINI are ceiling luminaires dedicated for bathrooms and rooms with increased humidity. Thanks to their design, they are resistant to moisture (IP44). Kanlux FLINI are available in two shapes - round and square. You can choose between matt white or matt black. Two such universal colours will allow us to match these lamps to almost any interior.

Enclosure material: aluminum alloy



FLINI IP44 DSL-B	33120	5905339331205	max 10	czarny black	brak none
FLINI IP44 DSL-W	33121	5905339331212	max 10	biały white	brak none
FLINI IP44 DSO-B	33122	5905339331229	max 10	czarny black	brak none
FLINI IP44 DSO-W	33123	5905339331236	max 10	biały white	brak none

12 AC; 12 DC; 220-240 AC	MR16/PAR16	Gx5,3/GU10	IP 44/20	
	Ø60	0,5m		

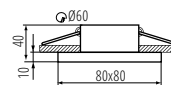

FLINI IP44 DSL

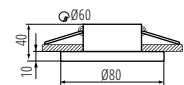

FLINI IP44 DSO

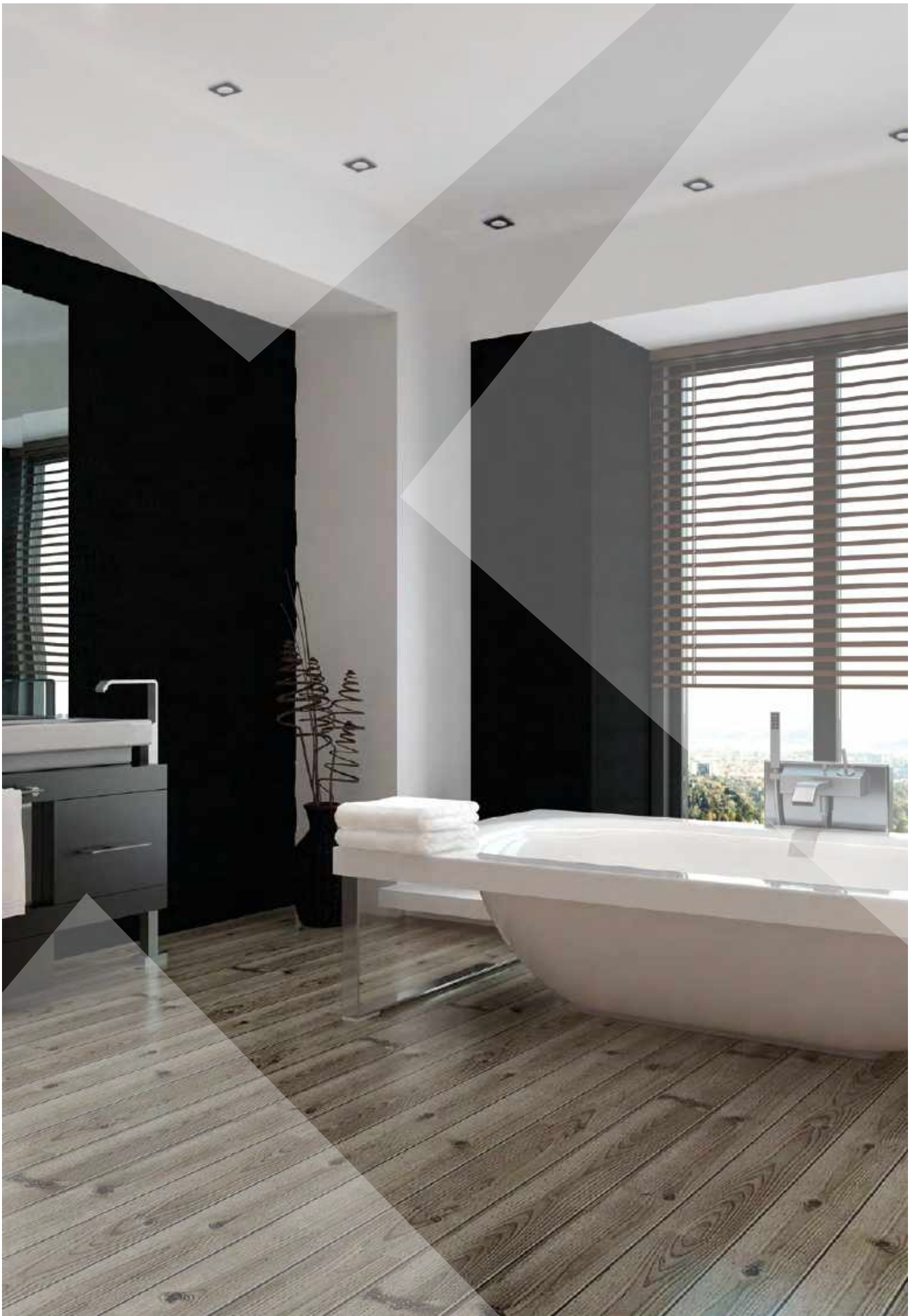

Kanlux QULES

OPRAWA SUFITOWA PUNKTOWA ► CEILING-MOUNTED SPOTLIGHT FITTING



QULES AC L-W



**IP
44/20**

Sufitowe oczka Kanlux QULES to jedne z najpopularniejszych opraw o podwyższonym IP. Idealnie nadają się do zamontowania w łazience lub innych miejscach o podwyższonej wilgotności.

Materiał obudowy: stop aluminium

The Kanlux QULES ceiling eyes are one of the most popular holders with increased IP. They are ideal for mounting in a bathroom or in other places with increased humidity.

Enclosure material: aluminum alloy



QULES AC O-W



QULES AC O-C/M



QULES AC L-C/M



QULES AC O-C



QULES AC O-B

NEW



QULES AC L-B

NEW



QULES AC L-W	26300	5905339263001	max 35	biały white	brak none
QULES AC L-C/M	26301	5905339263018	max 35	chrom mat chrome matte	brak none
QULES AC O-W	26303	5905339263032	max 35	biały white	brak none
QULES AC O-C/M	26304	5905339263049	max 35	chrom mat chrome matte	brak none
QULES AC O-C	26305	5905339263056	max 35	chrom chrome	brak none
QULES AC O-B	26306	5905339263063	max 35	czarny black	brak none
QULES AC L-B	26307	5905339263070	max 35	czarny black	brak none

[V] 220-240 AC	[Hz] 50	[W] PAR16	[lm] GU10	[mm] Ø71-74	[m] 0,5m	CE	ERAC	IP 44/20	Kanlux

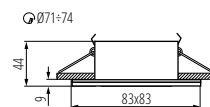

QULES AC L

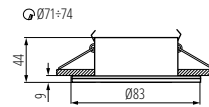

QULES AC O

Kanlux

MARIN

OPRAWA SUFITOWA PUNKTOWA ▶ CEILING-MOUNTED SPOTLIGHT FITTING



MARIN CT-S80-C



MARIN CT-S80-SN



MARIN CT-S80-AB



MARIN CT-S80-W



MARIN CT-S80-B



**IP
44/20**

Kanlux MARIN to niewielki szczelne oprawy sufitowe, których możemy użyć w miejscach o podwyższonej wilgotności. Swobodnie możemy je umieścić w łazience nad lustrem, w kuchni czy w pralni.

Materiał obudowy: stal

Kanlux MARIN means small and tight ceiling holders to be used in places with increased humidity. They can easily be placed in a bathroom above a mirror, in a kitchen or in a laundry.

Enclosure material: steel



MARIN CT-S80-C	04703	5905339047038	max 35	chrom chrome	brak none
MARIN CT-S80-SN	04704	5905339047045	max 35	nikiel mat nickel matte	brak none
MARIN CT-S80-AB	04710	5905339047106	max 35	mosiądz matowy matt brass	brak none
MARIN CT-S80-W	32500	5905339325006	max 35	biały white	brak none
MARIN CT-S80-B	32501	5905339325013	max 35	czarny mat black matt	brak none

IP 12 AC; 12 DC	MR-16	Gx5,3	IP 44/20	CE	EAC
Ø60-62 [mm]	0,12 [m]	0,75 [mm]	0,5m	CE	EAC

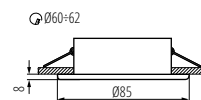

MARIN CT



ARGUS CT-2114-G



Kanlux ARGUS to najpopularniejsze i zarazem najprostsze w swojej formie oczko. Różnorodność wśród kształtów i kolorów sprawi, że każdy miłośnik klasyki znajdzie wśród nich coś dla siebie. Do oczek Kanlux ARGUS pasują żarówki z trzonkiem Gx5,3 (12V).

Materiał obudowy: stal

Kanlux ARGUS are the most popular and at the same time the simplest eye in its form. Diversity of shapes and colours will make each fan of classics find something for themselves among them. Bulbs with Gx5.3 (12V) light bulb base match the Kanlux ARGUS eyes.

Enclosure material: steel



ARGUS CT-2114-G	00300	5905339003003	max 50	złoty gold	brak no
ARGUS CT-2114-C	00301	5905339003010	max 50	chrom chrome	brak no
ARGUS CT-2114-W	00303	5905339003034	max 50	biały white	brak no
ARGUS CT-2115-G	00304	5905339003041	max 50	złoty gold	w jednej osi in one axis 15
ARGUS CT-2115-C	00305	5905339003058	max 50	chrom chrome	w jednej osi in one axis 15
ARGUS CT-2115-W	00307	5905339003072	max 50	biały white	w jednej osi in one axis 15
ARGUS CT-2117-C	00309	5905339003096	max 50	chrom chrome	w jednej osi in one axis 45
ARGUS CT-2117-W	00311	5905339003119	max 50	biały white	w jednej osi in one axis 45
ARGUS CT-2114-BR/M	00324	5905339003249	max 50	mosiądz matowy matt brass	brak no
ARGUS CT-2114-C/M	00325	5905339003256	max 50	chrom mat chrome matte	brak no
ARGUS CT-2114-AN	00327	5905339003270	max 50	miedź matowa matte copper	brak no
ARGUS CT-2114-GM	00328	5905339003287	max 50	grafitowy graphite	brak no
ARGUS CT-2115-BR/M	00330	5905339003300	max 50	mosiądz matowy matt brass	w jednej osi in one axis 15
ARGUS CT-2115-C/M	00331	5905339003317	max 50	chrom mat chrome matte	w jednej osi in one axis 15
ARGUS CT-2115-AN	00333	5905339003331	max 50	miedź matowa matte copper	w jednej osi in one axis 15
ARGUS CT-2115-GM	00334	5905339003348	max 50	grafitowy graphite	w jednej osi in one axis 15
ARGUS CT-2117-BR/M	00336	5905339003362	max 50	mosiądz matowy matt brass	w jednej osi in one axis 45
ARGUS CT-2117-C/M	00337	5905339003379	max 50	chrom mat chrome matte	w jednej osi in one axis 45
ARGUS CT-2117-GM	00340	5905339003409	max 50	grafitowy graphite	w jednej osi in one axis 45

TVI 12 AC; 12 DC	MR-16	Gx5,3	IP 20	5+25
	[m] 0,12	[mm] 0,75	[m] 0,5m	CE

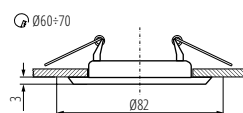

ARGUS CT-2114

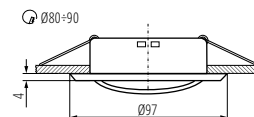

ARGUS CT-2115

Kanlux ARGUS

OPRAWA SUFITOWA PUNKTOWA ▶ CEILING-MOUNTED SPOTLIGHT FITTING



ARGUS CT-2114-C



ARGUS CT-2114-W



ARGUS CT-2114-C/M



ARGUS CT-2114-AN



ARGUS CT-2114-BR/M



ARGUS CT-2114-GM



ARGUS CT-2115-C



ARGUS CT-2115-W



ARGUS CT-2115-C/M



ARGUS CT-2115-AN



ARGUS CT-2115-BR/M



ARGUS CT-2115-GM



ARGUS CT-2115-G



ARGUS CT-2117-C



ARGUS CT-2117-W



ARGUS CT-2117-C/M



ARGUS CT-2117-BR/M



ARGUS CT-2117-GM

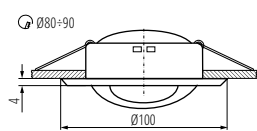

ARGUS CT-2117



Kanlux ALOR

PIERŚCIEŃ OPRAWY PUNKTOWEJ ► RING FOR SPOTLIGHT FITTINGS



ALOR DTO-B



ALOR DSL-W



ALOR DSL-B



ALOR DSL-C



ALOR DSL-C/M



ALOR DTL-B



ALOR DSO-B



ALOR DSL-W	26726	5905339267269	max 35	biały mat matte white	brak none
ALOR DSL-B	26727	5905339267276	max 35	czarny mat black matt	brak none
ALOR DSL-C	26728	5905339267283	max 35	chrom chrome	brak none
ALOR DSL-C/M	26729	5905339267290	max 35	chrom mat chrome matte	brak none
ALOR DTL-B	26732	5905339267320	max 35	czarny mat black matt	w jednej osi in one axis 30
ALOR DSO-B	26791	5905339267917	max 35	czarny mat black matt	brak none
ALOR DTO-B	26796	5905339267962	max 35	czarny mat black matt	w jednej osi in one axis 30

[V] 12 AC; 12 DC; 220-240 AC	MR16/PAR16	Gx5,3/GU10	CE	Kanlux
IP 20	5+25	0,5m	CE	Kanlux

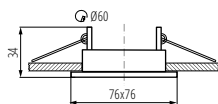

ALOR DSL

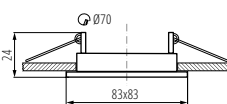

ALOR DTL

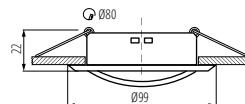

ALOR DTO

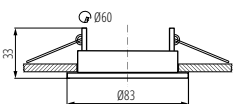

ALOR DSO



Kanlux ALOR to prosta kolorystycznie paleta jednych z najbardziej popularnych oczek sufitowych o średnicy 8,3 cm. Oczka nie posiadają w komplecie oprawki ceramicznej. Możemy tu zastosować oprawkę, która będzie pasować do trzonka GU10 lub Gx5,3, co pozwoli nam na zastosowanie źródeł światła dopasowanych do przygotowanej instalacji.

Pierścien dekoracyjny bez oprawki ceramicznej

Materiał obudowy: stal

Kanlux ALOR is a palette simple in terms of colours of one of the most popular ceiling eyes with diameter of 8.3 cm. The eyes do not have a ceramic frame in the set. You can use a frame here which will match the GU10 or Gx5.3 light bulb base, which will allow us to use light sources adapted to a prepared installation.

Decorative ring without a ceramic frame
Enclosure material: steel

Kanlux BASK

OPRAWA SUFITOWA PUNKTOWA ► CEILING-MOUNTED SPOTLIGHT FITTING



BASK CTC-5515-MPC/N



BASK CTC-5515-SN/N



BASK CTC-5514-MPC/N



BASK CTC-5514-SN/N

Kanlux BASK to proste oczka z delikatnym motywem ozdobnym. Ich atutem jest klasyczna kolorystyka. Do oczek Kanlux BASK pasują żarówki z trzonkiem Gx5,3 (12V).

Materiał obudowy: stop aluminium

Kanlux BASK are simple eyes with a delicate decorative motif. Bulbs with Gx5.3 (12V) light bulb base match the Kanlux BASK eyes.

Enclosure material: aluminum alloy



BASK CTC-5515-MPC/N	02804	5905339028044	max 50	chrom satynowy / nikiel satin chromium / nickel	w jednej osi in one axis	15
BASK CTC-5515-SN/N	02806	5905339028068	max 50	nikiel mat / nikiel nickel matte / nickel	w jednej osi in one axis	15
BASK CTC-5514-MPC/N	02814	5905339028143	max 50	chrom satynowy / nikiel satin chromium / nickel	brak none	
BASK CTC-5514-SN/N	02816	5905339028167	max 50	nikiel mat / nikiel nickel matte / nickel	brak none	

IV						
12 AC; 12 DC	MR-16		Gx5,3		IP 20	
5÷25	0,12	0,75	0,5m			

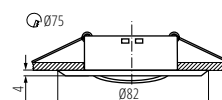

BASK CTC-5515

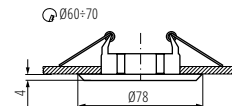

BASK CTC-5514

Kanlux HORN

OPRAWA SUFITOWA PUNKTOWA ► CEILING-MOUNTED SPOTLIGHT FITTING



HORN CTC-3114-SN/G



HORN CTC-3114-SN/N



HORN CTC-3114-PG/N



HORN CTC-3114-GM/N



HORN CTC-3115-SN/G



HORN CTC-3115-SN/N



HORN CTC-3115-GM/N



Bardzo duża rodzina popularnych oczek Kanlux HORN to przekrój; od klasycznych modeli po odważne zestawienia kolorystyczne. Wśród nich każdy wybierze swoje ulubione.

Materiał obudowy: stal



A very large family of the popular Kanlux HORN eyes is a range of classic models and a brave colour compilation. Everyone will choose the favourite one from among them.

Enclosure material: steel



HORN CTC-3114-SN/G	02820	5905339028204	max 50	nikiel mat / złoty nickel matte / gold	brak none
HORN CTC-3114-SN/N	02821	5905339028211	max 50	złoty matowy / nikiel matte gold / nickel	brak none
HORN CTC-3114-PG/N	02823	5905339028235	max 50	złoty / nikiel gold / nickel	brak none
HORN CTC-3114-GM/N	02824	5905339028242	max 50	grafitowy / nikiel graphite / nickel	brak none
HORN CTC-3115-SN/G	02830	5905339028303	max 50	nikiel mat / złoty nickel matte / gold	w jednej osi in one axis 15
HORN CTC-3115-SN/N	02831	5905339028310	max 50	nikiel mat / nikiel nickel matte / nickel	w jednej osi in one axis 15
HORN CTC-3115-GM/N	02834	5905339028341	max 50	grafitowy / nikiel graphite / nickel	w jednej osi in one axis 15

12 AC; 12 DC	MR-16	Gx5,3	IP 20	5+25	0,12	0,75	0,5m	CE	EAC	Kanlux

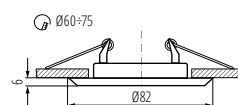

HORN CTC-3114

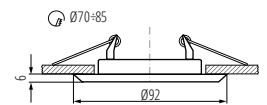

HORN CTC-3115

Kanlux URTICA

OPRAWA SUFITOWA PUNKTOWA ► CEILING-MOUNTED SPOTLIGHT FITTING



Ozdobna oprawa Kanlux URTICA wyróżnia się bogatymi, odważnymi wręcz zdobieniami na pierścieniu. Oprawa wymaga przemyślanego zestawienia z wnętrzem, w którym chcemy ją umieścić. Jednak efekt, który dzięki niej uzyskujemy może być naprawdę wyjątkowy.

Materiał obudowy: stop aluminium

The Kanlux URTICA decorative holder is distinguished by rich, even brave decors on the ring. The holder requires a well-thought-of combination with interiors where you want to place it. However, the effect generated by it can be really exceptional.

Enclosure material: aluminum alloy



URTICA CT-DT050-AB



URTICA CT-DT050-AB | 19550 | 5905339195500 | max 50 | mosiądz patynowany | patinated brass | w jednej osi | in one axis | 30

[V] 12 AC; 12 DC	MR-16	Gx5,3	III	IP 20	5+25	Ø75-80	0,12	0,75	0,5m	CE	EAC	Kanlux
5+25	Ø75-80	0,12	0,75	0,5m	CE	EAC	Kanlux					

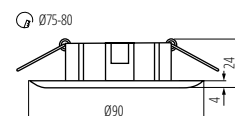

URTICA CT

Kanlux CANTA

OPRAWA SUFITOWA PUNKTOWA ► CEILING-MOUNTED SPOTLIGHT FITTING



Elegancka w formie Kanlux CANTA w kolorze transparentnego chromu powstała z nieszabloneowego połączenia szkła i stali. Stanowi ona wyjątkową ozdobę pomieszczenia. Posiada również dodatkowy atut jakim jest unikalny sposób rozsyłu światła.

Materiał obudowy: stal, szkło

Kanlux CANTA elegant in its form in the colour of transparent chromium was made of unconventional combination of glass and steel. It is an exceptional ornament of a room. It also has an additional asset i.e. a unique way of distributing light.

Enclosure material: steel, glass



CANTA CTX-DS20



CANTA CTX-DS20 | 19610 | 5905339196101 | max 20 | chrom / transparentny | chrome / transparent

[V] 12 AC; 12 DC	JC	G4	III	IP 20	5+25	Ø53-85	0,5m	CE	EAC	Kanlux
5+25	Ø53-85	0,5m	CE	EAC	Kanlux					

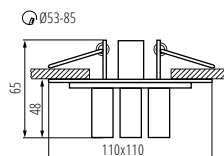

CANTA CTX-DS20

Kanlux DINO

OPRAWA SUFITOWA PUNKTOWA ► CEILING-MOUNTED SPOTLIGHT FITTING



DINO CTX-DS02G/B-C



DINO CTX-DS02G/B-C | 02576 | 5905339025760 max 50 chrom | chrome brak | none

12 AC; 12 DC	MR-16		Gx5,3			IP 20	
5+25	Ø60-70		0,12	0,75	0,5m		

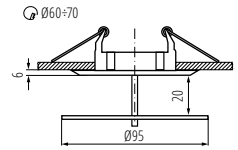

DINO CTX-DS02G/B-C

Kanlux NOMA

OPRAWA SUFITOWA PUNKTOWA ► CEILING-MOUNTED SPOTLIGHT FITTING



NOMA CTX-DS10G/B-C

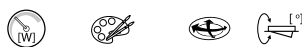

NOMA CTX-DS10G/B-C | 02566 | 5905339025661 max 50 chrom | chrome brak | none

12 AC; 12 DC	MR-16		Gx5,3			IP 20	
5+25	Ø60-70		0,12	0,75	0,5m		

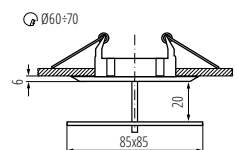

NOMA CTX-DS10G/B-C

Kanlux DINO to okrągła oprawa, która wyróżnia się ciekawym wzornictwem. Nietypowe połączenie aluminium z dystansowo umieszczoną, otwartą z boków, szklaną osłoną stanowi niespotykany element dekoracyjny, który doda ciekawego efektu każdemu pomieszczeniu, w którym się znajduje.

Materiał obudowy: stop aluminium

Kanlux DINO is a round holder which is distinguished by interesting design. Untypical combination of aluminium with a glass shield placed at a distance, open from its sides, is a unique decorative element which will add an interesting effect to each room where it is located.

Enclosure material: aluminum alloy

Kanlux NOMA to kwadratowa oprawa, która wyróżnia się ciekawym wzornictwem. Nietypowe połączenie aluminium z dystansowo umieszczoną, otwartą z boków, szklaną osłoną stanowi niespotykany element dekoracyjny, który doda ciekawego efektu każdemu pomieszczeniu, w którym się znajduje.

Materiał obudowy: stop aluminium

Kanlux NOMA is a square holder which is distinguished by interesting design. Untypical combination of aluminium with a glass shield placed at a distance, open from its sides, is a unique decorative element which will add an interesting effect to each room where it is located.

Enclosure material: aluminum alloy

IMBER LED

OPRAWA AKCENTOWA LED ► LED MIRROR LIGHT FITTING



IMBER LED NW

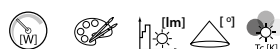

IMBER LED NW	23520	5905339235206	1	aluminium	40	105	4000
IMBER LED CW	23521	5905339235213	1	aluminium	40	105	6500

[V] 12 AC; 12 DC	 ≥20000	 30000	 Ra ≥80	 SMD	 IP 65		 -20+50		 Ø27	 0,1m		
----------------------------	------------	-----------	---------------	---------	--------------	--	------------	--	---------	----------	--	--

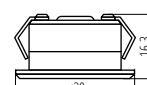

IMBER LED



Kanlux IMBER LED to wodoszczelna oprawa akcentowa do wbudowania. Jednym z jej atutów jest niska temperatura pracy, dzięki czemu może być bez przeszkód mocowana również w drewnie. Unikatowa konstrukcja oprawy to równomierna emisja światła, a zastosowane tu diody LED gwarantują dużą energooszczędność. Oprawa Kanlux IMBER LED to doskonały pomysł na podświetlenie kabin prysznicowych czy podbitek dachowych na zewnątrz domu.

Materiał obudowy: stop aluminium

Materiał klosza: tworzywo sztuczne

Kanlux IMBER LED is a waterproof holder intended for building in. Low temperature of work is one of its assets, thanks to which it can be easily mounted in wood as well. The unique structure of the holder means a regular emission of light and LED diodes used here guarantee high energy efficiency. The Kanlux IMBER LED holder is a perfect idea to highlight shower baths or outdoor soffits outside a house.

Enclosure material: aluminum alloy

Lampshade material: plastic

HAXA LED

OPRAWA AKCENTOWA LED ► LED MIRROR LIGHT FITTING



HAXA-DSO POWER LED-B



HAXA-DSO POWER LED-B	08103	5905339081032	1	aluminium	15	3000
----------------------	--------------	---------------	---	-----------	----	------

In [mA] 350	 100000	 Ra ≥80	 IP 20		 5+25		 Ø32	 0,1m			
-----------------------	------------	---------------	--------------	--	----------	--	---------	----------	--	--	--



Ścienne-sufitowa oprawa punktowa Kanlux HAXA LED to niewielkie oczko, które zastosujemy jako oświetlenie uzupełniające.

Do prawidłowego działania wymagany zasilacz elektroniczny o prądzie stałym 350mA, np. ADI 350 lub RICO dostępny w ofercie Kanlux

Materiał obudowy: stop aluminium

Materiał klosza: tworzywo sztuczne

The wall and ceiling spot-beam holder Kanlux HAXA LED is a small eye to be used as additional lighting.

An electronic 350-mA DC power supply unit is required for proper functioning, e.g. ADI 350 or RICO available from Kanlux

Enclosure material: aluminum alloy

Lampshade material: plastic

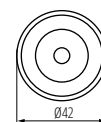
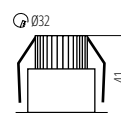

HAXA-DSO

Kanlux

OYO LED

AKCENT ŚWIETLNY LED ► LED MIRROR LIGHTS



Kanlux OYO to punktowe akcenty świetlne, które zastosujemy jako oświetlenie ozdobne. Niewielkie punkty świetlne pomogą nam zrealizować śmiałe projekty oświetleniowe również w saunach i łazienkach dzięki wysokiej szczelności - IP68.

OYO 2LED-CW w komplecie 2 sztuki

OYO 5LED-CW w komplecie 5 sztuk

Materiał obudowy: metal, tworzywo sztuczne

Kanlux OYO are spot-beam light accents to be used as decorative lighting. The small light points will help us to implement brave lighting projects also in saunas and bathrooms thanks to high tightness - IP68.

OYO 2LED-CW, 2 pcs included

OYO 5LED-CW, 5 pcs included

Enclosure material: Metal, plastic



OYO 2LED-CW



OYO 2LED-CW	08120	5905339081209	0,22	aluminium	15	6000-8000
OYO 5LED-CW	08121	5905339081216	0,22	chrom chrome	15	6000-8000

			IP 68		
12 DC	30000				
0,2	0,1m				

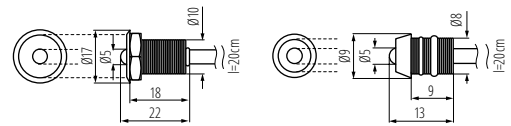

OYO 2LED

OYO 5LED

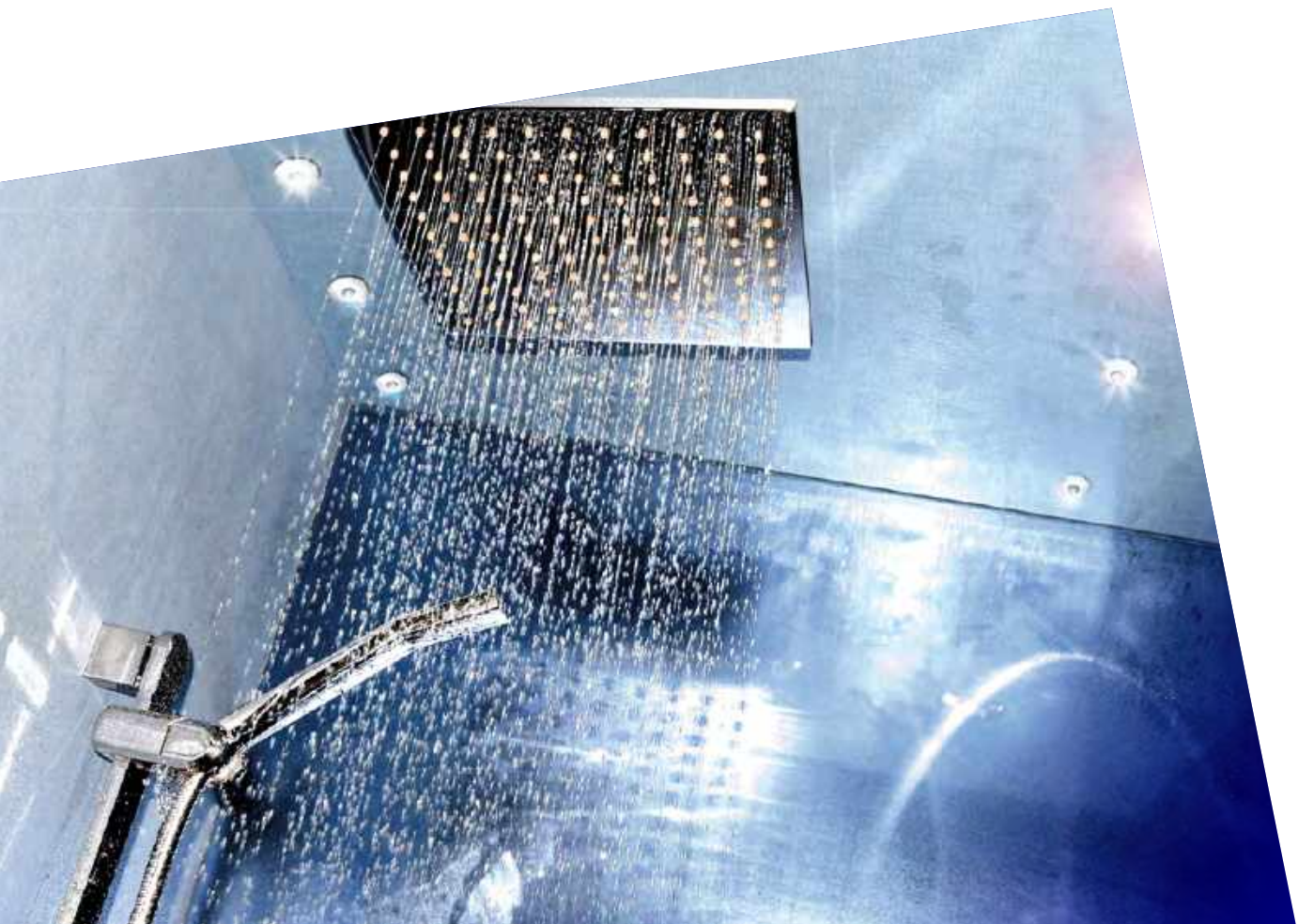

Kanlux ASIL

OPRAWA ŚCIENNA ► WALL-MOUNTED LIGHT FITTING



ASIL G9 W-B



ASIL G9 W-GR



ASIL G9 W-W



Kanlux ASIL to kinkiety, które dzięki swojemu kształtowi tworzą bardzo ciekawy efekt świetlny na ścianie. Światło rozchodzi się nie tylko do góry i na dół, ale również wydobywa się przez specjalnie zaprojektowaną szczelinę. Dzięki oprawie Kanlux ASIL stworzymy przytulny nastrój w domu, wnętrzu hotelowym lub uzupełnimy oświetlenie w restauracji czy kawiarni.



Materiał obudowy: stop aluminium

Kanlux ASIL are wall lamps which, thanks to their shape, create a very interesting light effect on a wall. Light does not only part upwards and downwards but it is also emitted through a specially designed slit. Thanks to the Kanlux ASIL holder, you can create a cosy atmosphere at home, in hotel interiors or you can complete lighting in a restaurant or coffee shop.



Enclosure material: aluminum alloy



ASIL G9 W-B	27020	5905339270207	max 40	czarny black
ASIL G9 W-GR	27021	5905339270214	max 40	szary grey
ASIL G9 W-W	27022	5905339270221	max 40	biały white

[V] 220-240 AC	[Hz] 50/60	G9	G9	IP 20	5+25	0,5m	CE	ERL	Kanlux

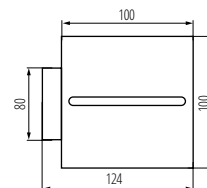

ASIL G9

Kanlux

PESSA LED

OPRAWA ŚCIENNA LED IP44 ► WALL-MOUNTED LED LIGHT FITTING, IP44



PESSA LED IP44 9W-NW



PESSA LED IP44 17W-NW



PESSA LED IP44 9W-NW	27531	5905339275318	9	biały white	700	4000
PESSA LED IP44 17W-NW	27533	5905339275332	17	biały white	1400	4000

[V]	[Hz]			[h]		Ra			
220-240 AC	50/60		≥15000	20000	≤6x MacAdam	≥80	SMD		
IP 44						0,75+1,5	0,5m	CE	ERC

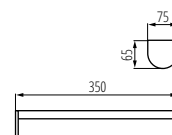

PESSA LED IP44 9W

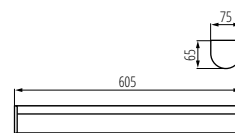

PESSA LED IP44 17W

Kanlux

ROLSO LED

OPRAWA ŚCIENNA LED IP44 ► WALL-MOUNTED LED LIGHT FITTING, IP44



ROLSO LED IP44 15W-NW



ROLSO LED IP44 15W-NW	26700	5905339267009	15	biały / chrom white / chrome	1080	4000
-----------------------	--------------	---------------	----	--------------------------------	------	------

[V]	[Hz]			[h]		Ra			
220-240 AC	50/60		≥15000	25000	≤6x MacAdam	≥80	SMD		
IP 44						0,75+1,5	0,1m	CE	ERC

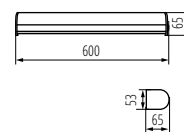

ROLSO LED IP44 15W

IP 44

Kanlux PESSA LED to liniowa oprawa, która cechuje się szczelnością na poziomie IP44. Z powodzeniem rozświetlimy nią łazienki lub pokoje kąpielowe.

Materiał obudowy: stop aluminium, tworzywo sztuczne
Materiał klosza: tworzywo sztuczne

Kanlux PESSA LED is a linear fixture, characterised by the IP44 protection classification. You can successfully brighten up bathrooms or washrooms with it.

Enclosure material: aluminum alloy, plastic
Lampshade material: plastic

IP 44

Kanlux ROLSO LED to nowoczesna oprawa domowa LED, której dodatkowym atutem jest subtelny design, który doskonale współgra zwłaszcza z nowoczesnymi wnętrzami. Oprawa ta świetnie sprawdzi się jako oświetlenie łazienkowe, dzięki współczynnikowi IP44.

Materiał obudowy: stop aluminium
Materiał klosza: tworzywo sztuczne

Kanlux ROLSO LED is a modern LED home holder whose additional asset is subtle design which perfectly cooperates in particular with modern interiors. This holder will work well as lighting of bathrooms, thanks to the IP44 coefficient.

Enclosure material: aluminum alloy
Lampshade material: plastic

ASTEN LED

OPRAWA ŚCIENNA LED IP44 ► WALL-MOUNTED LED LIGHT FITTING, IP44



ASTEN LED IP44 8W-NW



ASTEN LED IP44 12W-NW



ASTEN LED IP44 15W-NW



ASTEN IP44 8W-NW-B

NEW



ASTEN IP44 12W-NW-B

NEW



Kanlux ASTEN LED jest liniową oprawą ścienną, którą zastosujesz w miejscach o podwyższonej wilgotności (IP44). Bez obaw możesz zamontować ją nad lustrem w łazience. Lampa posiada wbudowane źródła światła oparte na diodach LED SMD, których trwałość wynosi przynajmniej 25000 godzin.

Materiał obudowy: stop aluminium
Materiał klosza: tworzywo sztuczne

Kanlux ASTEN LED is a linear wall luminaire to be used in places with increased humidity (IP44). You can easily mount it above the bathroom mirror. The lamp has a built-in light source based on SMD LED diodes, which lifetime is at least 25,000 hours.

Enclosure material: aluminum alloy
Lampshade material: plastic



Model	Code	Part No.	Length [mm]	Color	Power [W]	Beam Angle [°]
ASTEN LED IP44 8W-NW	26680	5905339266804	8	biały / chrom white / chrome	650	4000
ASTEN LED IP44 12W-NW	26681	5905339266811	12	biały / chrom white / chrome	1000	4000
ASTEN LED IP44 15W-NW	26682	5905339266828	15	biały / chrom white / chrome	1350	4000
ASTEN IP44 8W-NW-B	26683	5905339266835	8	czarny black	570	4000
ASTEN IP44 12W-NW-B	26684	5905339266842	12	czarny black	850	4000

[V] 220-240 AC	[Hz] 50	IP 44	≥15000	25000	≤6 MacAdam	Ra ≥80	SMD	CE	ERAC	Kanlux
		5+30			0,75+1,5		0,1m			

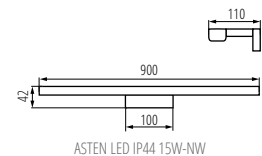
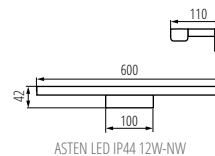
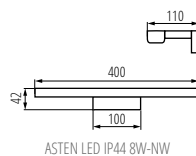



ERINUS LED

OPRAWA PRZYSCHODOWA LED ► STAIRCASE LED LIGHT FITTING

NEW



ERINUS LED L W

	[V]	[W]	[lm]	Tc [K]			
ERINUS LED L W-WW	33320	5905339333209	12 DC	0,8	biały white	15	3000
ERINUS LED L W-NW	33321	5905339333216	12 DC	0,8	biały white	15	4000
ERINUS LED O W-WW	33322	5905339333223	12 DC	0,8	biały white	15	3000
ERINUS LED O W-NW	33323	5905339333230	12 DC	0,8	biały white	15	4000
ERINUS LED LL W-WW	33324	5905339333247	12 DC	1,5	biały white	30	3000
ERINUS LED LL W-NW	33325	5905339333254	12 DC	1,5	biały white	30	4000
ERINUS LED L GR-WW	33326	5905339333261	12 DC	0,8	szary grey	15	3000
ERINUS LED L GR-NW	33327	5905339333278	12 DC	0,8	szary grey	15	4000
ERINUS LED O GR-WW	33328	5905339333285	12 DC	0,8	szary grey	15	3000
ERINUS LED O GR-NW	33329	5905339333292	12 DC	0,8	szary grey	15	4000
ERINUS LED LL GR-WW	33330	5905339333308	12 DC	1,5	szary grey	30	3000
ERINUS LED LL GR-NW	33331	5905339333315	12 DC	1,5	szary grey	30	4000
ERINUS LED L B-WW	33332	5905339333322	12 DC	0,8	czarny black	15	3000
ERINUS LED L B-NW	33333	5905339333339	12 DC	0,8	czarny black	15	4000
ERINUS LED O B-WW	33334	5905339333346	12 DC	0,8	czarny black	15	3000
ERINUS LED O B-NW	33335	5905339333353	12 DC	0,8	czarny black	15	4000
ERINUS LED LL B-WW	33336	5905339333360	12 DC	1,5	czarny black	30	3000
ERINUS LED LL B-NW	33337	5905339333377	12 DC	1,5	czarny black	30	4000

[V] 12 DC
≥15000
30000
klippre ≤60Mackdam
Ra ≥80
IP 20
0,1m
SMD
5±25
CE
ERC

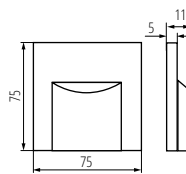

ERINUS LED L

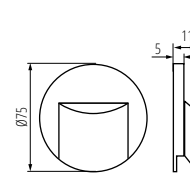

ERINUS LED O

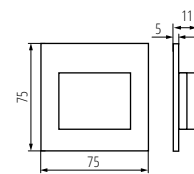

ERINUS LED LL



Kanlux ERINUS to wyjątkowa seria opraw przyschodowych wykonanych z tworzywa. Oprawy te charakteryzują się niezwykłą lekkością z powodu materiałów, z których zostały stworzone, a jednocześnie są wykonane z dużą precyzją i dbałością o detale. Oprawy Kanlux ERINUS są bardzo cienkie, dzięki czemu licują się za ścianą i stanowią jej dyskretną dekorację. Do wyboru mamy trzy kolory (biały, czarny i szary), dwie barwy światła (ciepła i neutralna) i trzy różne modele opraw. Kanlux ERINUS L to kwadratowa oprawa świecąca w jedną stronę, model LL świeci w dwie strony, a model Kanlux ERINUS O to okrągła oprawa świecąca w jedną stronę.

Material obudowy: tworzywo sztuczne

Kanlux ERINUS is a unique series of premium stairwaf fittings made of plastic. These luminaires are characterized by exceptional lightness due to the materials from which they were made, and at the same time they are made with great precision and attention to detail. Kanlux ERINUS are very thin, so they flush with the wall line and make it a discreet decoration. We have three colors to choose (white, black and gray), two colors of light (warm and neutral light) and three different models of luminaires. The Kanlux ERINUS L is a square luminaire glowing in one direction, the LL model shines in both directions, and the Kanlux ERINUS O is a round luminaire glowing in one direction.

Enclosure material: plastic

Kanlux

ERINUS LED

OPRAWA PRZYSCHODOWA LED ► STAIRCASE LED LIGHT FITTING



ERINUS LED L B



ERINUS LED L GR



ERINUS LED L W



ERINUS LED O B



ERINUS LED O GR



ERINUS LED O W



ERINUS LED LL B



ERINUS LED LL GR



ERINUS LED LL W



APUS LED

OPRAWA PRZYSCHODOWA LED ► STAIRCASE LED LIGHT FITTING



APUS LED AC; APUS LED



APUS LED PIR B



APUS LED B



APUS LED W

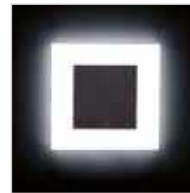
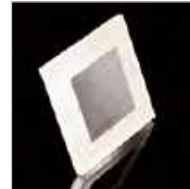

Kanlux APUS to nowoczesny design połączony z atrakcyjnym efektem świecenia. To doskonały pomysł na podświetlenie schodów i korytarzy lub na zaakcentowanie wystroju pomieszczeń. Unikatowa konstrukcja oprawy zapewnia równomierną emisję światła. Wersja AC wyposażona jest w zasilacz 230V, który mieści się w puszcze, a wersja PIR w czujnik ruchu. Czujnik wykrywa ruch/włącza oświetlenie niezależnie od natężenia światła w otoczeniu.

Materiał obudowy: stal nierdzewna szlifowana, tworzywo sztuczne

Kanlux APUS means modern design combined with an attractive effect of lighting. It is a perfect idea to highlight stairs and corridors or to emphasize decor of rooms. The unique structure of the holders ensures even emission of light. The AC version is equipped with 230V power supply unit which fits into a box and the PIR version is equipped with a motion sensor. The sensor detects movement / turns lights on regardless of the ambient light intensity.

Enclosure material: polished stainless steel, plastic



	[W]	[V]	[m]	[K]				
APUS LED WW	23106	5905339231062	12 DC	0,8	stal nierdzewna	stainless steel	13	3000
APUS LED CW	23107	5905339231079	12 DC	0,8	stal nierdzewna	stainless steel	15	6500
APUS LED AC-WW	23800	5905339238009	220-240 AC	1,3	stal nierdzewna	stainless steel	13	3000
APUS LED AC-CW	23801	5905339238016	220-240 AC	1,3	stal nierdzewna	stainless steel	15	6500
APUS LED AC B-NW	26536	5905339265364	220-240 AC	1,3	czarny	black	14	4000
APUS LED AC B-WW	26537	5905339265371	220-240 AC	1,3	czarny	black	13	3000
APUS LED B-NW	26538	5905339265388	12 DC	0,8	czarny	black	14	4000
APUS LED B-WW	26539	5905339265395	12 DC	0,8	czarny	black	13	3000
APUS LED W-WW	26840	5905339268402	12 DC	0,8	biały	white	13	3000
APUS LED W-CW	26841	5905339268419	12 DC	0,8	biały	white	15	6500
APUS LED PIR WW	27370	5905339273703	12 DC	0,8	stal nierdzewna	stainless steel	13	3000
APUS LED PIR CW	27371	5905339273710	12 DC	0,8	stal nierdzewna	stainless steel	15	6500
APUS LED PIR B-NW	29856	5905339298560	12 DC	0,8	czarny	black	14	4000
APUS LED PIR B-WW	29857	5905339298577	12 DC	0,8	czarny	black	13	3000

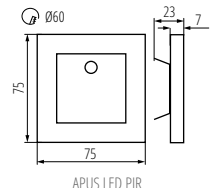
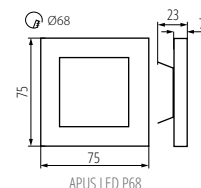
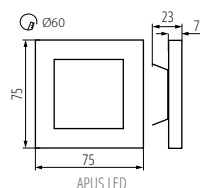
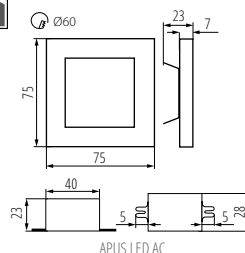

TERRA LED

OPRAWA PRZYSCHODOWA LED ▶ STAIRCASE LED LIGHT FITTING



TERRA LED B; TERRA LED AC B



TERRA MINI LED B



TERRA LED PIR B



TERRA LED W

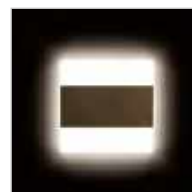

Kanlux TERRA to nowoczesny design połączony z atrakcyjnym efektem świecenia. To doskonały pomysł na podświetlenie schodów i korytarzy lub na zaakcentowanie wystroju pomieszczeń. Unikatowa konstrukcja oprawy zapewnia równomierną emisję światła. Wersja AC wyposażona jest w zasilacz 230V, który mieści się w puszcze, a wersja PIR w czujnik ruchu. Czujnik wykrywa ruch/włącza oświetlenie niezależnie od natężenia światła w otoczeniu.

Materiał obudowy: stal nierdzewna szlifowana, tworzywo sztuczne

Kanlux TERRA means modern design combined with an attractive effect of lighting. It is a perfect idea to highlight stairs and corridors or to emphasize decor of rooms. The unique structure of the holders ensures even emission of light. The AC version is equipped with 230V power supply unit which fits into a box and the PIR version is equipped with a motion sensor. The sensor detects movement / turns lights on regardless of the ambient light intensity.

Enclosure material: polished stainless steel, plastic



	[V]	[W]				[lm]	Tc (K)
TERRA LED WW	23102	5905339231024	12 DC	0,8	stal nierdzewna stainless steel	13	3000
TERRA LED CW	23104	5905339231048	12 DC	0,8	stal nierdzewna stainless steel	15	6500
TERRA LED AC-WW	23806	5905339238061	220-240 AC	1,3	stal nierdzewna stainless steel	13	3000
TERRA LED AC-CW	23807	5905339238078	220-240 AC	1,3	stal nierdzewna stainless steel	15	6500
TERRA LED W-WW	26842	5905339268426	12 DC	0,8	biały white	13	3000
TERRA LED W-CW	26843	5905339268433	12 DC	0,8	biały white	15	6500
TERRA LED AC B-NW	26846	5905339268464	220-240 AC	1,3	czarny black	14	4000
TERRA LED AC B-WW	26847	5905339268471	220-240 AC	1,3	czarny black	13	3000
TERRA LED B-NW	26848	5905339268488	12 DC	0,8	czarny black	14	4000
TERRA LED B-WW	26849	5905339268495	12 DC	0,8	czarny black	13	3000
TERRA LED PIR WW	27372	5905339273727	12 DC	0,8	stal nierdzewna stainless steel	13	3000
TERRA LED PIR CW	27373	5905339273734	12 DC	0,8	stal nierdzewna stainless steel	15	6500
TERRA MINI LED B-NW	27376	5905339273765	12 DC	0,8	czarny black	14	4000
TERRA MINI LED B-WW	27377	5905339273772	12 DC	0,8	czarny black	13	3000
TERRA LED PIR B-NW	29860	5905339298607	12 DC	0,8	czarny black	14	4000
TERRA LED PIR B-WW	29861	5905339298614	12 DC	0,8	czarny black	13	3000

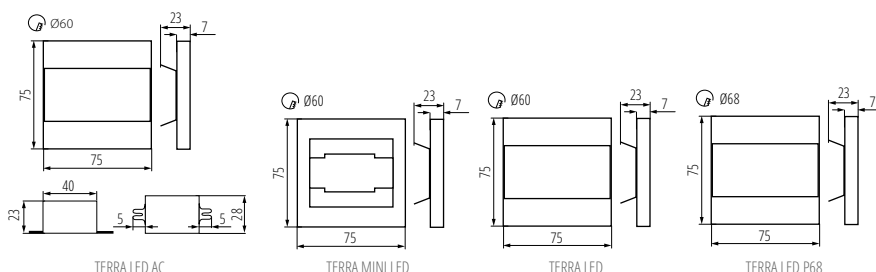
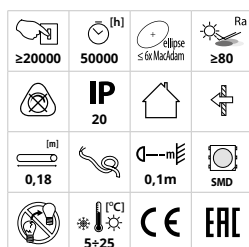

SEORA LED

OPRAWA PRZYSCHODOWA LED ► STAIRCASE LED LIGHT FITTING



SEORA LED B



SEORA LED



Kanlux SEORA to oprawa, dzięki której oświetlisz schody lub ciągi komunikacyjne. Możesz też zaakcentować wybrane miejsca w domu. Ciekawy i elegancki design oraz równomierna emisja światła to dodatkowe atuty oprawy Kanlux SEORA. Oprawy zasilane napięciem 12 V do prawidłowego działania wymagają zasilacza (np. DRIFT LED 0-6W).

Materiał obudowy: stal nierdzewna szlifowana, tworzywo sztuczne

Kanlux SEORA is a staircase LED light fitting that allows you to illuminate stairs or passageways. You can also emphasize a selected place in the house. Interesting and elegant design and regular light emission are additional advantages of the Kanlux SEORA. Luminaires powered with voltage of 12 V. It require for proper operation powersupply (e.g DRIFT LED 0-6W).

Enclosure material: polished stainless steel, plastic



Model	Code	Power	Voltage	Current	Material	Color	lm	Tc [K]
SEORA LED AC B-NW	32480	5905339324801	220-240 AC	1,3	czarny black	black	14	4000
SEORA LED AC B-WW	32481	5905339324818	220-240 AC	1,3	czarny black	black	13	3000
SEORA LED B-NW	32482	5905339324825	12 DC	0,8	czarny black	black	14	4000
SEORA LED B-WW	32483	5905339324832	12 DC	0,8	czarny black	black	13	3000
SEORA LED AC NW	32484	5905339324849	220-240 AC	1,3	stal nierdzewna stainless steel	black	14	4000
SEORA LED AC WW	32485	5905339324856	220-240 AC	1,3	stal nierdzewna stainless steel	black	13	3000
SEORA LED NW	32486	5905339324863	12 DC	0,8	stal nierdzewna stainless steel	black	14	4000
SEORA LED WW	32487	5905339324870	12 DC	0,8	stal nierdzewna stainless steel	black	13	3000

≥20000	50000	ellipse ≤ 60° (Max)	Ra ≥80		IP 20
		0,18	0,1m		
5+25					

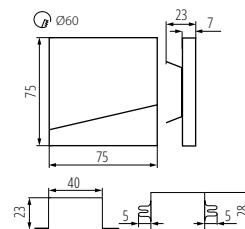

SEORA LED AC

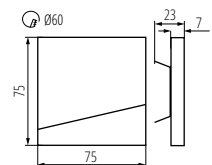

SEORA LED

SABIK LED

OPRAWA PRZYSCHODOWA LED ▶ STAIRCASE LED LIGHT FITTING



SABIK LED; SABIK LED AC



SABIK LED PIR



SABIK MINI LED B



SABIK LED B



SABIK LED WW	23108	5905339231086	12 DC	0,8	stal nierdzewna stainless steel	13	3000
SABIK MINI LED WW	23109	5905339231093	12 DC	0,8	stal nierdzewna stainless steel	13	3000
SABIK LED CW	23110	5905339231109	12 DC	0,8	stal nierdzewna stainless steel	15	6500
SABIK MINI LED CW	23111	5905339231116	12 DC	0,8	stal nierdzewna stainless steel	15	6500
SABIK LED AC-WW	23802	5905339238023	220-240 AC	1,3	stal nierdzewna stainless steel	13	3000
SABIK LED AC-CW	23803	5905339238030	220-240 AC	1,3	stal nierdzewna stainless steel	15	6500
SABIK LED PIR WW	27374	5905339273741	12 DC	0,8	stal nierdzewna stainless steel	13	3000
SABIK LED PIR CW	27375	5905339273758	12 DC	0,8	stal nierdzewna stainless steel	15	6500
SABIK LED AC B-NW	29850	5905339298508	220-240 AC	1,3	czarny black	14	4000
SABIK LED AC B-WW	29851	5905339298515	220-240 AC	1,3	czarny black	13	3000
SABIK LED B-NW	29852	5905339298522	12 DC	0,8	czarny black	14	4000
SABIK LED B-WW	29853	5905339298539	12 DC	0,8	czarny black	13	3000
SABIK MINI LED B-NW	29854	5905339298546	12 DC	0,8	czarny black	14	4000
SABIK MINI LED B-WW	29855	5905339298553	12 DC	0,8	czarny black	13	3000
SABIK LED PIR B-NW	29858	5905339298584	12 DC	0,8	czarny black	14	4000
SABIK LED PIR B-WW	29859	5905339298591	12 DC	0,8	czarny black	13	3000



Kanlux SABIK to nowoczesny design połączony z atrakcyjnym efektem świecenia. To doskonały pomysł na podświetlenie schodów i korytarzy lub na zaakcentowanie wystroju pomieszczeń. Unikatowa konstrukcja oprawy zapewnia równomierną emisję światła. Wersja AC wyposażona jest w zasilacz 230V, który mieści się w puszcze, a wersja PIR w czujnik ruchu. Czujnik wykrywa ruch/włącza oświetlenie niezależnie od natężenia światła w otoczeniu.

Materiał obudowy: stal nierdzewna szlifowana, tworzywo sztuczne

Kanlux SABIK means modern design combined with an attractive effect of lighting. It is a perfect idea to highlight stairs and corridors or to emphasize decor of rooms. The unique structure of the holders ensures even emission of light. The AC version is equipped with 230V power supply unit which fits into a box and the PIR version is equipped with a motion sensor. The sensor detects movement / turns lights on regardless of the ambient light intensity.

Enclosure material: polished stainless steel, plastic

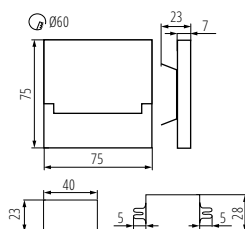
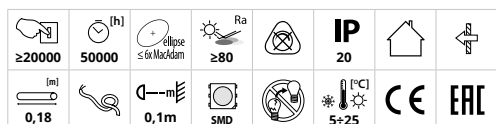

SABIK LED AC

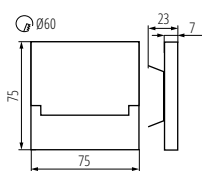

SABIK LED

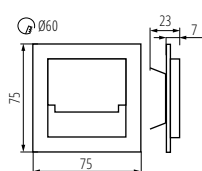

SABIK MINI LED

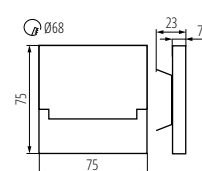

SABIK LED P68

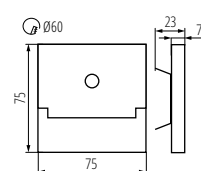

SABIK LED PIR

SOLA LED

OPRAWA PRZYSCHODOWA LED ► STAIRCASE LED LIGHT FITTING



SOLA LED; SOLA LED AC



SOLA LED B; SOLA LED AC B



Kanlux SOLA to nowoczesny design połączony z atrakcyjnym efektem świecenia. To doskonały pomysł na podświetlenie schodów i korytarzy lub na zaakcentowanie wystroju pomieszczeń. Unikatowa konstrukcja oprawy zapewnia równomierną emisję światła. Wersja AC wyposażona jest w zasilacz 230V, który mieści się w puszcze.

Oprawa przystosowana do montażu w puszkach elektroinstalacyjnych Ø 60.

Materiał obudowy: stal nierdzewna szlifowana, tworzywo sztuczne

Kanlux SOLA means modern design combined with an attractive effect of lighting. It is a perfect idea to highlight stairs and corridors or to emphasize decor of rooms. The unique structure of the holders ensures even emission of light. The AC version is equipped with 230V power supply unit which fits into a box.

The fitting is suitable for mounting in Ø 60 junction boxes.

Enclosure material: polished stainless steel, plastic



SOLA LED WW	23100	5905339231000	12 DC	0,8	stal nierdzewna stainless steel	13	3000
SOLA LED CW	23101	5905339231017	12 DC	0,8	stal nierdzewna stainless steel	15	6500
SOLA LED AC-WW	23804	5905339238047	220-240 AC	1,3	stal nierdzewna stainless steel	13	3000
SOLA LED AC-CW	23805	5905339238054	220-240 AC	1,3	stal nierdzewna stainless steel	15	6500
SOLA LED AC B-NW	27556	5905339275561	220-240 AC	1,3	czarny black	14	4000
SOLA LED AC B-WW	27557	5905339275578	220-240 AC	1,3	czarny black	13	3000
SOLA LED B-NW	27558	5905339275585	12 DC	0,8	czarny black	14	4000
SOLA LED B-WW	27559	5905339275592	12 DC	0,8	czarny black	13	3000

≥20000	50000	ellipse ≤ 6m Maxdram	Ra ≥80	IP 20		5+25	
0,18		0,1m	SMD				

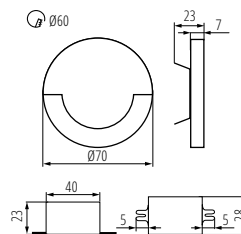

SOLA LED AC

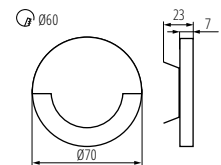

SOLA LED

MERA LED

OPRAWA PODSZAFKOWA LED ► LED UNDER CABINET FITTING



MERA LED 5W NW



MERA LED 10W NW



MERA LED 15W NW



MERA LED 20W NW



MERA LED 5W NW	29210	5905339292100	5	biały white	490	4000
MERA LED 10W NW	29211	5905339292117	10	biały white	1040	4000
MERA LED 15W NW	29212	5905339292124	15	biały white	1600	4000
MERA LED 20W NW	29213	5905339292131	20	biały white	2030	4000

[V] 220-240 AC	[Hz] 50/60		 150	 ≥15000	 30000	 ≤ 6° MacAdam	 Ra ≥80					
IP 20					 0,3m	 1,5	 5+25					

AKCESORIA ► ACCESSORIES

MERA LED PP | **29214** | 5905339292148 Przewód do łączenia opraw MERA LED PP | Luminaire connecting cable MERA LED PP



Kanlux MERA LED to oprawa podszafkowa ze zintegrowanym źródłem światła LED. Oprawy są dostępne w rozmiarach od 28 do 114 cm, ponadto możemy je łączyć w linii (do 5 opraw) z pomocą łączników Kanlux MERA LED PP.

Materiał obudowy: tworzywo sztuczne

Materiał klosza: tworzywo sztuczne

Kanlux MERA LED is an under-cupboard luminaire with an integrated LED light source. The luminaires are available in sizes ranging from 28 to 114 cm. Moreover, we can connect them in lines (up to 5 luminaires) using Kanlux MERA LED PP connectors.

Enclosure material: plastic

Lampshade material: plastic

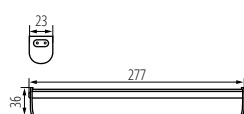

MERA LED 5W NW



MERA LED 10W NW



MERA LED 15W NW

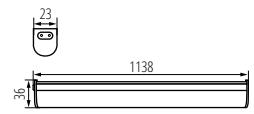

MERA LED 20W NW

Kanlux MERA

OPRAWA PODSZAFKOWA ► UNDER-CABINET LIGHT FITTING



MERA TL-8/4000K



MERA TL-13/4000K



MERA TL-21/4000K



Kanlux MERA to popularna oprawa podszafkowa, którą możemy łączyć w linie. Oprawa doświetli nam blaty w kuchni i wszystkie miejsca, gdzie nie dociera górne światło.

Możliwość zasilania przelotowego, przy pomocy przewodu łączeniowego MERA PP do 18 opraw MERA TL-8, do 11 opraw MERA TL-13, do 8 opraw MERA TL-21, do 6 opraw MERA TL-28 albo do 4 opraw MERA TL-35.

Materiał obudowy: tworzywo sztuczne
Materiał klosza: tworzywo sztuczne

Kanlux MERA is a popular under-cabinet fitting which can be combined in lines. The holder will additionally light table tops in a kitchen and all places deprived of upper light.

Optional feed-through power supply using MERA PP connection cable for 18 MERA TL-8 light fixtures, 11 MERA TL-13 light fixtures, 8 MERA TL-21 fixtures, 6 MERA TL-28 fixtures or 4 MERA TL-35 fixtures.

Enclosure material: plastic
Lampshade material: plastic



MERA TL-8/4000K	04730	5905339047304	8	biały white
MERA TL-13/4000K	04731	5905339047311	13	biały white
MERA TL-21/4000K	04732	5905339047328	21	biały white
MERA TL-13/2700K	08302	5905339083029	13	biały white

[V] 220-240 AC	[Hz] 50/60							IP 20	
					0,3m		1,75		5+25

AKCESORIA ► ACCESSORIES

MERA PP | **04733** | 5905339047335 | Przewód do łączenia opraw MERA PP | Luminaire connecting cable MERA PP

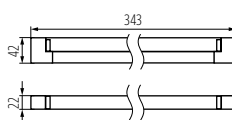

MERA TL-8/4000K

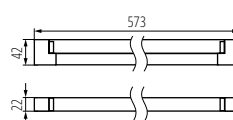

MERA TL-13/2700K; 4000K

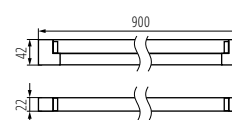

MERA TL-21/4000K

LINUS LED

OPRAWA PODSZAFKOWA LED ► LED UNDER CABINET FITTING



LINUS LED 4W-NW



Oprawa podszafkowa Kanlux LINUS LED posiada klasyczny i uniwersalny design. Dzięki swym kompaktowym rozmiarom lampa idealnie sprawdzi się do podświetlania różnego rodzaju mebli, szafek jak i półek. Kanlux LINUS LED można łączyć przelotowo przy pomocy przewodu LINUS LINK.

Materiał obudowy: tworzywo sztuczne
Materiał klosza: tworzywo sztuczne

Kanlux LINUS LED under-cabinet holder has classic and universal design. Thanks to its compact dimensions, the lamp will ideally highlight different types of furniture, cabinets and shelves. Kanlux LINUS LED can be combined on a pass-through basis by means of LINUS LINK cable.

Enclosure material: plastic
Lampshade material: plastic



LINUS LED 4W-NW	27590	5905339275905	4	biały white	330	4000
LINUS LED 7W-NW	27591	5905339275912	7	biały white	630	4000

[V] 220-240 AC	[Hz] 50/60			 ≥15000	 30000	 ≤ 60° Max beam	 Ra ≥80					
IP 20		[m] 1,5		 0,1m	 5+25							

AKCESORIA ► ACCESSORIES

LINUS LINK | **14977** | 5907540960618 | Przewód do łączenia opraw LINUS LINK | Luminaire connecting cable LINUS LINK

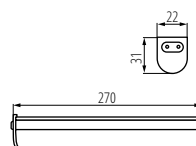

LINUS LED 4W

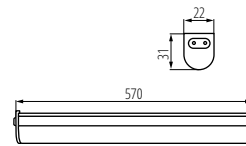

LINUS LED 7W

ZEPO

OPRAWA PODSZAFKOWA PUNKTOWA ► UNDER-CABINET SPOTLIGHT FITTING



ZEPO LFD-T02-C/M



Seria oczek Kanlux ZEPO to oświetlenie przeznaczone pod szafki m.in. nad kuchennym blatem. Kanlux ZEPO dostępne są w wersji z wyłącznikiem jak i bez. Do opraw wymagany jest zasilacz np. z serii SET. Źródło światła przeznaczone do oczek to JC z gwintem G4.

Oprawa ZEPO LFD-T02/S-C/M, wyposażona we wyłącznik.
Materiał obudowy: stal
Materiał klosza: szkło

The Kanlux ZEPO series of eyes is the lighting intended under cabinets, for example, above a table top in a kitchen. ZEPOs are available in a version with an OFF switch and without it. The holders require a power supply unit e.g. from the SET series. JC with G4 thread is a light source intended for the eyes.

ZEPO LFD-T02/S-C/M light fixtures provided with a power switch
Enclosure material: steel
Lampshade material: glass

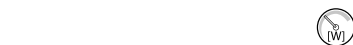

ZEPO LFD-T02-C/M	04381	5905339043818	max 20	chrom mat chrome matte
ZEPO LFD-T02/S-C/M	04386	5905339043863	max 20	chrom mat chrome matte

[V] 12 AC; 12 DC			IP 20				
	 0,3m	 0,1	 5+25				

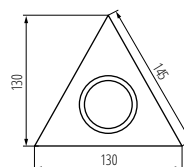

ZEPO LFD-T02

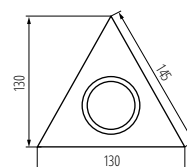

ZEPO LFD-T02/S

Kanlux PAX LED

OPRAWA PODSZAFKOWA LED
▶ LED UNDER CABINET FITTING



PAX LED 10W NW



Kanlux PAX LED to podszafkowe oprawy liniowe ze zintegrowanym źródłem światła. Dużym udogodnieniem jest możliwość skierowania strumienia światła w górę lub w dół.

Materiał obudowy: tworzywo sztuczne

Materiał klosza: tworzywo sztuczne

Kanlux PAX LED are under-cabinet linear holders with an integrated source of light. A possibility of directing the light stream upwards or downwards is a large convenience.

Enclosure material: plastic

Lampshade material: plastic



PAX LED 10W NW | 22192 | 5905339221926 | 10 srebrny | silver | 970 | 4000 | ≥12500

[V] 220-240 AC	[Hz] 50	[Ra] ≥80	SMD	IP 20	House icon
Beam angle icon	1+2,5	0,2m	5+25	CE	ERAC

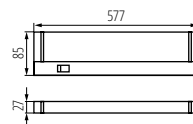

PAX LED 10W

Kanlux PIRMO LED

OPRAWA MEBLOWA LED
▶ LED LIGHT FITTING FOR FURNITURE UNITS



PIRMO LED SMD NW-GR



Kanlux PIRMO LED to nowoczesna oprawa meblowa, wyposażona w czujnik zbliżeniowy. Przeznaczona jest do oświetlenia szaf, barków czy większych komód. Wykonana z tworzywa sztucznego w kolorze aluminium, dostępna jest w neutralnej barwie światła. Zaletą oprawy jest szybki i łatwy montaż za pomocą dwóch wkrętów. Do prawidłowego działania oprawy, potrzebny jest zasilacz.

Materiał obudowy: tworzywo sztuczne

Materiał klosza: tworzywo sztuczne

Kanlux PIRMO LED is a modern furniture fitting, equipped with a proximity detector. It is intended for lighting cabinets, drinks cabinets or larger chests of drawers. It is made of plastic in aluminium colour and available in a neutral colour of light. Quick and easy assembly by means of two screws is an advantage of the holder. To be able to work properly, the holder requires a power supply unit.

Enclosure material: plastic

Lampshade material: plastic



PIRMO LED SMD NW-GR | 23710 | 5905339237101 | 1 szary | grey | 65 | 4000

[V] 12 DC	[Im] 65	≥15000	30000	Tc [K] 4000	±10% ≤ for MackCam	[Ra] ≥80	SMD	IP 20
House icon	5+25	0,1m	110	1,5	Im W 65	CE	ERAC	

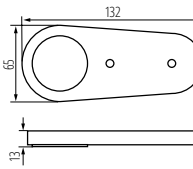

PIRMO LED SMD

Kanlux GAVI LED

OPRAWA MEBLOWA PUNKTOWA LED
▶ LED SPOTLIGHT FITTING FOR FURNITURE UNITS



GAVI LED 18 SMD-WW-C/M

Kanlux GAVI LED to oprawy meblowe wykonane ze szkła i stali. Bezpretensjonalna kolorystyka pozwala im dyskretnie wpasować się w miejsce montażu. Oprawy Kanlux GAVI LED posiadają zintegrowane źródło światła

Materiał obudowy: stal

Kanlux GAVI LED are furniture fittings made of glass and steel. Unpretentious colour scheme allows them to discretely fit into the place of assembly. Kanlux GAVI LED holders have an integrated source of light

Enclosure material: steel



GAVI LED 18 SMD-WW-C/M | 19761 | 5905339197610 | 0,8 chrom mat | chrome matte | 42 | 2800-3200

[V] 12 DC	≥15000	30000	[Ra] ≥80	SMD	IP 20
House icon	5+25	0,1m	Ø60	CE	ERAC

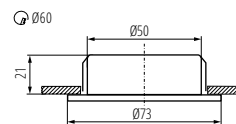

GAVI LED 18 SMD

Kanlux GAVI

OPRAWA MEBLOWA PUNKTOWA ► SPOTLIGHT FITTING FOR FURNITURE UNITS



GAVI CT-2116B-W



GAVI CT-2116B-C



GAVI CT-2116B-BR/M



GAVI CT-2116B-C/M

Kanlux GAVI to oprawy meblowe wykonane ze szkła i stali. Bezpretensjonalna kolorystyka pozwala im dyskretnie wpasować się w miejsce montażu.

Materiał obudowy: stal

Kanlux GAVI are furniture fittings made of glass and steel. Unpretentious colour scheme allows them to discretely fit into the place of assembly.

Enclosure material: steel



GAVI CT-2116B-W	00810	5905339008107	max 20	biały white
GAVI CT-2116B-C	00811	5905339008114	max 20	chrom chrome
GAVI CT-2116B-BR/M	00814	5905339008145	max 20	mosiądz matowy matt brass
GAVI CT-2116B-C/M	00815	5905339008152	max 20	chrom mat chrome matte

12 AC; 12 DC	G4	G4	IP 20	IP 20	5+25
0,5m	0,5m	0,5m	CE	ENEC	Kanlux
Ø60	Ø60	Ø60	A A A B C D E	A A A B C D E	A A A B C D E

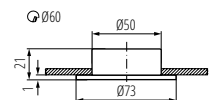

GAVI CT-2116B

Kanlux

RUBINAS LED

OPRAWA MEБLOWA AKCENTOWA LED ► LED MIRROR LIGHT FITTING FOR FURNITURE UNITS



RUBINAS 2LED WW	23790	5905339237903	1	szary grey	40	3000
RUBINAS 2LED CW	23791	5905339237910	1	szary grey	40	6500
RUBINAS 3LED WW	23792	5905339237927	1,5	szary grey	50	3000
RUBINAS 3LED CW	23793	5905339237934	1,5	szary grey	50	6500

[V] 12 DC	≥15000	(h) 30000	ellipse ≤ 6x MacAdam	Ra ≥80	SMD	⊗	⚠
IP 20	5+25	(lm) 1,5	CE	EAC	Kanlux		



Kanlux RUBINAS LED to dekoracyjna meбlowa oprawa LED. Oprawa montowana jest na półce. Przy szklanych półkach możemy skorzystać z wersji, która oprócz świecenia w górę i w dół rozświetli nam również samą półkę tworząc unikatowy efekt dekoracyjny.

Materiał obudowy: stop aluminium

Kanlux RUBINAS LED is a decorative furniture LED fitting. The holder is mounted on a shelf. With regard to glass shelves, you can use the version which, apart from lighting upwards and downwards, will light up the shelf itself too, creating a unique decorative effect.

Enclosure material: aluminum alloy

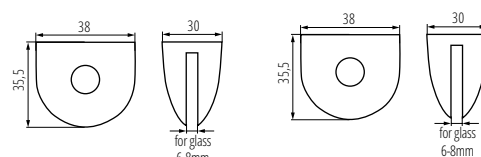

RUBINAS 2LED CW; WW

RUBINAS 3LED CW; WW

Kanlux

ZAFIRAS LED

OPRAWA MEБLOWA AKCENTOWA LED ► LED MIRROR LIGHT FITTING FOR FURNITURE UNITS



ZAFIRAS LED WW	23700	5905339237002	1,5	szary grey	30	3000
ZAFIRAS LED CW	23701	5905339237019	1,5	szary grey	30	6500

[V] 12 DC	≥15000	(h) 30000	ellipse ≤ 6x MacAdam	Ra ≥80	SMD	⊗	⚠
IP 20	5+25	(lm) 1,5	CE	EAC	Kanlux		



Kanlux ZAFIRAS LED to dekoracyjna meбlowa oprawa LED. Oprawę montujemy na półce uzyskując przy tym świecenie w dwóch kierunkach - góra i dół.

Materiał obudowy: metal, PC

Kanlux ZAFIRAS LED is a decorative furniture LED fitting. The holder is mounted on a shelf with an effect of lighting in two directions - upwards and downwards.

Enclosure material: Metal, PC

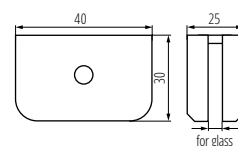

ZAFIRAS LED

Kanlux

DB

ROZDZIELACZ ► DISTRIBUTOR



DB-FF6 12/24VDC

Material obudowy: tworzywo sztuczne
Enclosure material: plastic

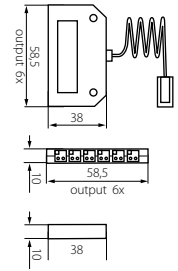

DB-FF6 12/24VDC



DB-FF6 12/24VDC | 23572 | 5905339235725 max 36W(12V)/72W (24V) biały | white

[V] 12 DC; 24 DC	III	IP 20	In[A] 3		CE	EAC
----------------------------	------------	-----------------	-------------------	--	-----------	------------

Kanlux

DIM

WYŁĄCZNIK / ŚCIEMIACZ LED ► LED SWITCH / DIMMER



DIM-FF1 12/24VDC

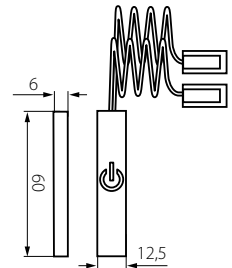

DIM-FF1 12/24VDC



DIM-FF1 12/24VDC | 23571 | 5905339235718 max 24W(12V)/48W (24V) biały | white

[V] 12 DC; 24 DC	III	IP 20	In[A] max 2		CE	EAC
----------------------------	------------	-----------------	-----------------------	--	-----------	------------

Kanlux

DRIFT

ZASILACZ LED ► LED POWER SUPPLY UNIT



DRIFT LED F 0-18W

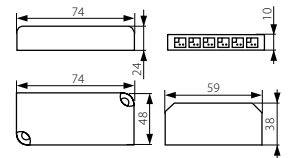

DRIFT LED F 0-18W



DRIFT LED F 0-18W | 18042 | 5905339180421 max 18 biały | white

[V] 220-240 AC	[Hz] 50/60	PRI [V] 220-240	SEC [V] 12V DC	IP 20		CE
--------------------------	----------------------	---------------------------	--------------------------	-----------------	--	-----------



Kanlux

REXAR LED

LAMPKA BIURKOWA LED ► LED DESK LAMP



NEW



REXAR LED B



REXAR LED W



changeable
COLOUR
temperature

DIMMABLE
FUNCTION
3

USB
PORT

HIGH
quality
finish

Lampka biurkowa Kanlux REXAR to minimalistyczny, elegancki design i mnóstwo funkcji. Możemy dowolnie regulować barwę światła i jego natężenie, a także skorzystać z portu USB, aby doładować urządzenie mobilne. Po skończonej pracy złożona lampka nie zajmie dużo miejsca i będzie pełnił funkcję minimalistycznej ozdoby.

Materiał obudowy: stop aluminium, tworzywo sztuczne

Kanlux REXAR desk lamp combines a minimalist, elegant design and plenty of functions. You can adjust the colour of the light and its intensity to suit your preferences, as well as use the USB port in order to charge a mobile device. Once it is switched off, a folded lamp does not occupy much space and serves as an uncluttered decoration.

Enclosure material: aluminum alloy, plastic

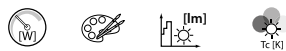

REXAR LED W	33070	5905339330703	max 7	biały white	max 400	3000/4000/6500
REXAR LED B	33071	5905339330710	max 7	czarny black	max 400	3000/4000/6500

[V] 220-240 AC	[Hz] 50	[lm] 100	[h] ≥15000	[h] 25000	[lm] ≤6w MacAdam	Ra ≥80	SMD	□
IP 20	0,1m	180	1,8	CE	ERC			

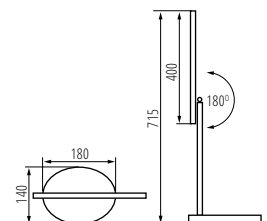

REXAR LED



Kanlux

ISTI LED

LAMPKA BIURKOWA LED ► LED DESK LAMP



ISTI LED B



Kanlux ISTI LED to nowoczesna lampka, wyposażona w dotykowy wyłącznik z 3-poziomą funkcją ściemniania, regulację temperatury barwowej i dodatkowe światło nocne (1W / 30lm).

Materiał obudowy: tworzywo sztuczne
Materiał klosza: tworzywo sztuczne

The Kanlux ISTI LED is a modern lamp, equipped with a touch switch with 3-level dimming function, colour-temperature control, and additional night light (1W / 30lm).

Enclosure material: plastic
Lampshade material: plastic

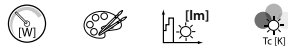

ISTI LED W	27360	5905339273604	max 10	biały white	max 500	2700/4500/6000
ISTI LED B	27361	5905339273611	max 10	czarny black	max 500	2700/4500/6000

[V]	[Hz]								
220-240 AC	50/60		110	≥15000	20000	≤6w MacAdam	≥80	SMD	IP 20
0,1m			180	1,5					

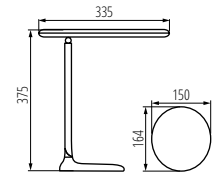

ISTI LED B

Kanlux

AWAN LED

LAMPKA BIURKOWA LED ► LED DESK LAMP



AWAN LED S-W

AWAN LED C-W



Kanlux AWAN LED to lampka, która posiada regulowane ramie, wyłącznik dotykowy z 3-poziomą regulacją jasności oraz dodatkowe podświetlenie podstawy. Dzięki pełnej regulacji ramienia lampka nie zajmuje dużo miejsca, a równocześnie pozwala nam skierować światło w dowolne miejsce. Kanlux AWAN LED C-W posiada dodatkowy, funkcjonalny wyświetlacz aktualnej godziny, daty i temperatury, budzik z funkcją drzemki, a także TIMER.

Materiał obudowy: tworzywo sztuczne
Materiał klosza: tworzywo sztuczne

Kanlux AWAN LED is a lamp with an adjustable arm, touch OFF switch with 3-level adjustment of brightness and additional highlight of the base. Thanks to full adjustment of the arm, the lamp does not need a lot of space and at the same time allows you to direct light into any place. Kanlux AWAN LED C-W has an additional, functional display screen showing the current time, date and temperature, an alarm clock with a snooze function as well as a TIMER.

Enclosure material: plastic
Lampshade material: plastic



AWAN LED S-W	26490	5905339264909	max 7	biały white	max 240	3000
AWAN LED C-W	26491	5905339264916	max 7	biały white	max 240	3000

[V]	[Hz]								
220-240 AC	50/60		110	≥15000	20000	≤6w MacAdam	≥80	SMD	IP 20
0,1m			180	1,2					

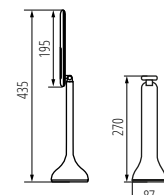

AWAN LED

Kanlux

SARI LED

LAMPKA BIURKOWA LED ► LED DESK LAMP



SARI LED B-CH



SARI LED B-SR



SARI LED W-SR



Kanlux SARI LED to LEDowa lampka biurkowa, nocna, stołowa - sami wybierzcie dla niej odpowiednie zastosowanie, pewne jest to, że jej design urzeka. Ponadczasowa elegancja to jej atut. Kanlux SARI LED ma wbudowane źródło LED o mocy 4,5W idealna sprawdza się przy odrabianiu lekcji, w kąciuku do czytania, a także jako lampka nocna. Swobodna regulacja kierunku świecenia i bardzo dobra jakość wykonania to kolejne zalety tej lampki.

Materiał obudowy: tworzywo sztuczne

Materiał klosza: tworzywo sztuczne

Kanlux SARI LED is a LED desk, bedside, table lamp - please choose its intended use for it on your own. It is undisputable that its design captivates. The supratemporal elegance is its asset. Kanlux SARI LED has an embedded LED source with power of 4.5W, ideal while doing homework, in a reading niche and also as a bedside lamp. The free adjustment of the light direction and very good quality of finishing touch are further advantages of this lamp.

Enclosure material: plastic

Lampshade material: plastic



SARI LED B-CH	27980	5905339279804	4,5	czarny / szampański black / champagne	270	3000
SARI LED B-SR	27981	5905339279811	4,5	czarny / srebrny black / silver	270	3000
SARI LED W-SR	27982	5905339279828	4,5	biały / srebrny white / silver	270	3000

[V]	[Hz]					
220-240 AC	50/60		95	≥15000	20000	≥80
			IP			
			20	0,1m		
180	180	1,5				

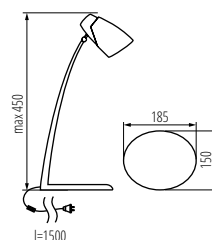

SARI LED

Kanlux

FOLLO LED

LAMPKA BIURKOWA LED ► LED DESK LAMP



FOLLO LED B



Kanlux FOLLO LED to nie tylko lampka biurkowa, ale również designerska ozdoba, każdego wnętrza. Lampka posiada specjalne podświetlenie krawędziowe i mleczny klosz, dzięki temu światło ma przyjemny ciepły odcień. Elegancja, minimalizm, giętkie ramię i 3 poziomy ściemniania to dodatkowe atuty lampki Kanlux FOLLO LED.

Materiał obudowy: tworzywo sztuczne

Materiał klosza: tworzywo sztuczne

The Kanlux FOLLO LED is not only a desk lamp, but also a design decoration for any interior. This lamp has a special edge illumination and a milky lampshade, thanks to which the light has a pleasant warm shade. The additional advantages of The Kanlux FOLLO lamp are its elegance, minimalism, flexible arm, and 3 levels of dimming.

Enclosure material: plastic

Lampshade material: plastic



FOLLO LED W	28790	5905339287908	6	biały white	max 340	3000
FOLLO LED B	28791	5905339287915	6	czarny black	max 340	3000

[V]	[Hz]								
220-240 AC	50/60		95	≥12000	20000	≥80	SMD	IP 20	0,1m
		360	360	1,8					

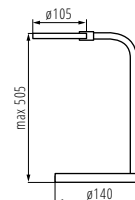

FOLLO LED

Kanlux

FRANCO LED

LAMPKA BIURKOWA LED ► LED DESK LAMP



FRANCO 15LED SMD KT-B



Kanlux FRANCO to opływowa w kształcie, dyskretna, a zarazem elegancka lampka stojąca. Świetna jako oświetlenie biurkowe, ale również jako dodatkowe oświetlenie pomieszczenia czy lampka nocna. Wygodnym rozwiązaniem jest możliwość regulacji natężenia światła, dzięki której możemy dopasować jasność oświetlenia do własnych potrzeb i pory dnia.

Wyposażona w sensor umieszczony w podstawie, dzięki któremu poprzez dotyk można włączyć/wyłączyć lampkę lub ustawić intensywność świecenia (3 stopnie jasności)

Materiał obudowy: tworzywo sztuczne

Materiał klosza: tworzywo sztuczne

Kanlux FRANCO is a streamlined, in terms of shape, discrete and at the same time elegant standing lamp. It works perfectly as the desk lighting and also as the additional lighting of a room or a bedside lamp. A possibility of adjusting the intensity of light is a convenient solution, thanks to which you can adapt brightness of light to own needs and time of day.

The base plate is provided with a sensor that enables switching on/off the lamp or controlling the light intensity by touch (3 brightness levels)

Enclosure material: plastic

Lampshade material: plastic



FRANCO 15LED SMD KT-W	22340	5905339223401	max 6,5	biały white	max 390	3000
FRANCO 15LED SMD KT-B	22341	5905339223418	max 6,5	czarny black	max 390	3000

[V]	[Hz]								
220-240 AC	50/60		100	≥10000	20000	≤60 MacAdam	≥80	SMD	IP 20
		360	360	1,8					

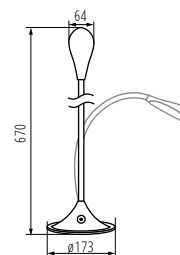

FRANCO 15LED SMD

Kanlux SUZI

LAMPKA BIURKOWA ► DESK LAMP



SUZI HR-60-SR



SUZI HR-60-B



SUZI HR-60-BL



SUZI HR-60-PK



Kanlux SUZI to prosta lampka biurkowa. Dostępna jest kilku jednolitych wersjach kolorystycznych. Kanlux SUZI posiada regulowane ramię i klips dzięki któremu możemy umocować lampkę na krawędzi biurka lub na półce.

Wysięgnik giętki

Montaż za pomocą klipsa

Materiał obudowy: tworzywo sztuczne

Materiał klosza: stal

Kanlux SUZI is a simple desk lamp. It is available in several uniform colour versions. Kanlux SUZI has an adjustable arm and a clip thanks to which you can fix the lamp on a desk edge or on a shelf.

Flexible exterior arm

Clip-on installation

Enclosure material: plastic

Lampshade material: steel

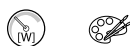

SUZI HR-60-SR	07150	5905339071507	max 40	srebrny silver
SUZI HR-60-B	07151	5905339071514	max 40	czarny black
SUZI HR-60-BL	07152	5905339071521	max 40	niebieski blue
SUZI HR-60-PK	07153	5905339071538	max 40	różowy pink

[V] 220-240 AC	[Hz] 50/60			IP 20			
	 360	 360	 1,5				

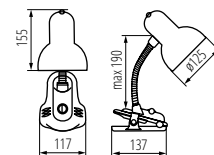
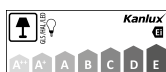

SUZI HR-60

Kanlux ZARA

LAMPKA BIURKOWA ► DESK LAMP



ZARA HR-40-B



ZARA HR-40-SR



ZARA HR-40-BL



ZARA HR-40-OR



Seria lampek biurkowych Kanlux ZARA to żywe i ciekawe kolory, które idealnie ożywią każde biurko. Do lampek biurkowych Kanlux ZARA pasują źródła światła z trzonkiem E14 o maksymalnej mocy 40W.

Materiał obudowy: stal
Materiał klosza: stal

The series of the Kanlux ZARA desk lamps means vivid and interesting colours which will ideally revive each desk. Light sources with E14 light bulb base with maximum power of 40W match the Kanlux ZARA desk lamps.

Enclosure material: steel
Lampshade material: steel



ZARA HR-40-SR	07560	5905339075604	max 40	srebrny silver
ZARA HR-40-B	07561	5905339075611	max 40	czarny black
ZARA HR-40-BL	07562	5905339075628	max 40	niebieski blue
ZARA HR-40-OR	07563	5905339075635	max 40	pomarańczowy orange

[V]	[Hz]			IP			
220-240 AC	50/60			20	0,2m		E14
	360	360	1,5				

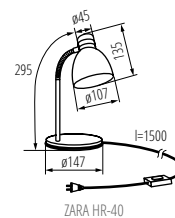

ZARA HR-40

Kanlux

HERON LED

LAMPKA BIURKOWA LED ► LED DESK LAMP



HERON LED-B



HERON LED B	27600	5905339276001	5	czarny black	400	4000
HERON LED W	27601	5905339276018	5	biały white	400	4000

[V]	[Hz]						Ra			
220-240 AC	50/60		110	≥15000	20000	ellipse ≤ 6x/lockdam	≥80	SMD		IP 20
0,1m			360	180	1,7					



Kanlux HERON LED to lampa biurkowa o wielu zaletach. Oprawa posiada wyłącznik oraz zacisk, który pozwala przytwierdzić podstawę do krawędzi blatu lub półki. Ruchomy, łamany wysięgnik lampy umożliwia precyzyjne skierowanie strumienia światła w wybrane przez nas miejsce. Kanlux HERON LED cieszy się zainteresowaniem osób, które cenią sobie nowoczesny, surowy design.

Materiał obudowy: stop aluminium

Materiał klosza: tworzywo sztuczne

The Kanlux HERON LED is a desk lamp with many advantages. The fixture has a switch, and a clamp, which allows you to fix the base to the edge of a tabletop or a shelf. The movable, bendable, lamp arm allows the precise directing of the luminous flux to the place you choose. The Kanlux HERON LED is very popular among people who appreciate modern, austere, design.

Enclosure material: aluminum alloy

Lampshade material: plastic

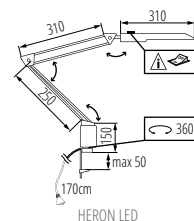

Kanlux

PIXA

LAMPKA BIURKOWA ► DESK LAMP



PIXA KT-40-W



PIXA KT-40-W	19300	5905339193001	max 40	biały white
PIXA KT-40-B	19301	5905339193018	max 40	czarny black

[V]	[Hz]					
220-240 AC	50/60		20	0,1m		E14
	360	180	1,6			

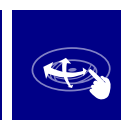

Kanlux PIXA to kultowa lampa biurkowa na wymienne źródło światła. Jej budowa pozwala skierować strumień świetlny w dowolnym kierunku przy czym klosz lampki ogranicza jego padanie na boki. Lampa ta doskonale wpisze się w każdy rodzaj wnętrza - od pokoju dziecięcego po biurko w gabinecie prezesa.

Materiał obudowy: tworzywo sztuczne, metal

Materiał klosza: metal

Kanlux PIXA is a cult desk lamp with a replaceable light source. Its structure allows directing the light stream into any direction with the reservation that the lampshade of the lamp reduces its falling aside. This lamp will perfectly fit into each type of interiors - from a child's room to a desk in an office of a president.

Enclosure material: plastic, Metal

Lampshade material: Metal

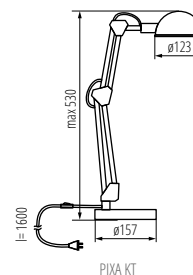



Kanlux
CYDEA

LAMPA STOŁOWA ► TABLE LAMP



CYDEA D



Kanlux CYDEA to oprawy, które możesz zastosować jako oświetlenie główne, a także jako uzupełniające, gdyż na tę rodzinę składa się: lampa podłogowa oraz stołowa. Dużym atutem tych opraw jest materiał, z jakiego został wykonany klosz, jest to folia polipropylenowa, która podlega recydingowi, a przede wszystkim jest niezwykle łatwa w utrzymaniu czystości.

Materiał obudowy: metal
Materiał klosza: folia polipropylenowa

Kanlux CYDEA are holders which can be used as main or additional lighting because this family comprises: a floor holder and table holder. The material of which the lampshade was made i.e. polypropylene foil which is subject to recycling and, mainly, can extremely easily be cleaned is a big asset of these holders.

Enclosure material: Metal
Lampshade material: Polypropylene film



CYDEA D | 25551 | 5905339255518 | max 40 | biały | white

[V]	[Hz]	[W]	[E]	[Lightbulb]	[IP]	[Temperature]	[Cable]	[CE]	[EAC]	[Kanlux logo]
220-240 AC	50/60	max 40	E14		IP 20	5+25	0,5m			

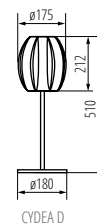

CYDEA D

Kanlux





OPRAWY TECHNICZNE I ARCHITEKTONICZNE
TECHNICAL AND ARCHITECTURAL FIXTURES

**Rozświetlamy już tysiące mieszkań,
setki biur i inwestycji.**

**Rozwijamy się dotrzymując kroku
pędzącej technologii, ale również
słuchając Twoich potrzeb.**

We are already lighting up thousands of flats,
and hundreds of offices and investment buildings.
We are developing at the same rate as all
the develop keeping pace with fast
evolving technology, all the while listening
to your needs.



*dane fotometryczne znajdziesz na:
photometric data you can find on:*

► kanlux.com

BLINGO BL

PANEL LED PODTYNKOWY ► RECESSED-MOUNTED LED PANEL



BLINGO R 38W 6060



BLINGO R 38W 12030



BLINGO RU 38W 6060



BLINGO TU 48W 6060



BLINGO P 38W 6060

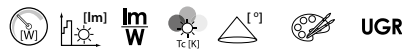

BLINGO R 38W 6060 NW	29822	5905339298225	38	3800	100	4000	120	biały white
BLINGO R 38W 12030 NW	29823	5905339298232	38	3800	100	4000	120	biały white
BLINGO RU 38W 6060 NW	29824	5905339298249	38	3800	100	4000	90	biały white < 19
BLINGO TU 48W 6060 NW	29825	5905339298256	48	6250	130	4000	90	biały white < 19
BLINGO P 38W 6060 NW	33180	5905339331809	38	4600	121	4000	120	biały white

[V] 220-240 AC	[Hz] 50	≥30000	50000	Ra ≥80	SMD
	IP 20		5÷25		
0,5m					

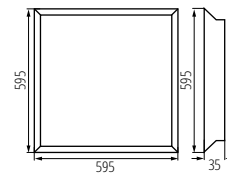

BLINGO 6060

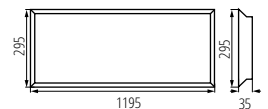

BLINGO 12030

BLINGO BL

PANEL LED PODTYNKOWY ► RECESSED-MOUNTED LED PANEL

LOW
UGR



W panelach Kanlux BLINGO moduły LED usytuowane są na tylnej ścianie panela i świecą kierunkowo w dół. To panele typu backlite wyposażone w soczewki poszerzające kąt emisji światła, które gwarantują równomierność podświetlenia. Wyeliminowanie płyty światłoprzewodzącej minimalizuje możliwość żółknięcia oprawy i pozwala uzyskać lepsze parametry świetlne. W Kanlux znajdziesz również całą gamę akcesoriów do paneli Kanlux BLINGO.

5 lat Gwarancji na warunkach oświadczenia gwarancyjnego, dostępnego na stronie internetowej

Materiał klosza: tworzywo sztuczne

Materiał panelu/ramki: stal

In Kanlux BLINGO panels, the LED modules are located on the rear panel wall and light directly downwards. These are backlit panels equipped with lenses that extend the angle of light emission, ensuring the uniformity of illumination. Elimination of the light-conducting plate greatly reduces the possibility of the luminaire yellowing and allows for better light parameters. We also provide a whole range of accessories for Kanlux BLINGO panels.

5 years Warranty under the terms of the warranty statement, available on our website

Lampshade material: plastic

Panel/frame material: steel

		ADTR										
		ADTR-H 6060 B	ADTR-H 6060 SR	ADTR-H 6060 W	ADTR-H 12030 B	ADTR-H 12030 SR	ADTR-H 12030 W	ADTR-H 76MM 6060 B (na indywidualne zamówienie / on individual order only)	ADTR-H 76MM 6060 SR (na indywidualne zamówienie / on individual order only)	ADTR-H 76MM 6060 W (na indywidualne zamówienie / on individual order only)	CLIPS BLINGO RT	SPN BRAVO S/P 60-62
index		29845	29844	29843	33391	33392	33390	33396	33397	33398	29826	28504
BLINGO P 38W 6060 NW	33180	✓	✓	✓							✓	✓
BLINGO R 38W 12030 NW	29823				✓	✓	✓				✓	✓
BLINGO R 38W 6060 NW	29822	✓	✓	✓							✓	✓
BLINGO RU 38W 6060 NW	29824	✓	✓	✓							✓	✓
BLINGO TU 48W 6060 NW	29825							✓	✓	✓	✓	✓



CLIPS BLINGO RT



SPN BRAVO S/P 60-62



ADTR-H W

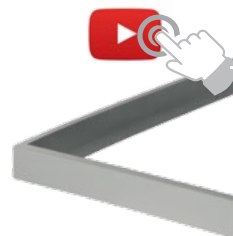

ADTR-H SR



ADTR-H B



BRAVO P / PU

PANEL LED PODTYNKOWY ► RECESSED-MOUNTED LED PANEL

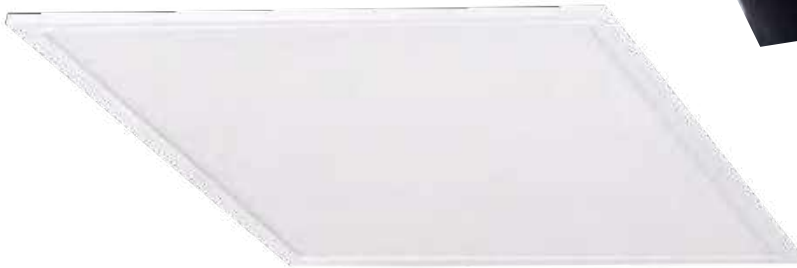

BRAVO P 36W6060



BRAVO P 36W6060



BRAVO PU36W6060



BRAVO PU28W3060

UGR DRIVER [index]

Model	Price	Part No.	W	H	lm	Tc [K]	Beam	Color	UGR	Driver
BRAVO P 36W6060NWW	28000	5905339280008	36	4320	4000	110	biały white	28025		
BRAVO PU36W6060NWW	28002	5905339280022	36	4320	4000	110	biały white	< 19	28025	
BRAVO PU36W6060NWSR	28003	5905339280039	36	4320	4000	110	srebrny silver	< 19	28025	
BRAVO P 36W6060CWW	28006	5905339280060	36	4320	6500	110	biały white	28025		
BRAVO P 45W6060NWW	28008	5905339280084	45	5400	4000	110	biały white	28027		
BRAVO P 36W12030NWW	28020	5905339280206	36	4320	4000	110	biały white	28025		
BRAVO PU36W6262NWW	28024	5905339280244	36	4320	4000	110	biały white	< 19	28025	
BRAVO PU28W3060NWW	28551	5905339285515	28	3360	4000	90	biały white	< 19	28029	

≥15000 30000 h ellipse s 6m MacAdam ≥80 SMD IP 20 5+25 °C 0,05 m

0,5 m 0,5m CE EAC Kanlux

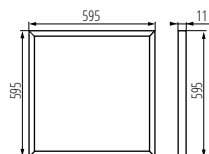

BRAVO P36W6060

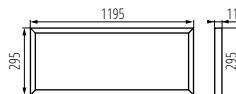

BRAVO P 36W12030

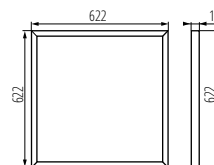

BRAVO PU36W6262

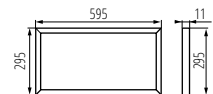

BRAVO PU28W3060

BRAVO P / PU

PANEL LED PODTYNKOWY ► RECESSED-MOUNTED LED PANEL



LOW UGR



Panele Kanlux BRAVO P/PU to specjalnie wybrane komponenty dla jeszcze większej satysfakcji z ich użytkowania. Aluminiowa ramka, specjalnie dobrane diody LED, odbłyśnik i dyfuzor rozpraszający światło to tylko niektóre atuty paneli Kanlux BRAVO LED P/PU. Kolejnym atutem tych paneli jest wysoka skuteczność świetlna (120lm/W). Pewni ich jakości udzielamy na nie 5 lat gwarancji. Panele Kanlux BRAVO LED nie posiadają zasilacza w komplecie.

5 lat Gwarancji na warunkach oświadczenia gwarancyjnego, dostępnego na stronie internetowej

Do prawidłowego działania wymagany jest zasilacz elektroniczny dostępny w ofercie KANLUX.

Brak zasilacza w komplecie.

Produkt o kodzie 28024 przeznaczony jest do alternatywno rozmiaru systemów sufitowych (625mmx625mm)

Atest PZH: Numer BK/B/1070/01/2018, ważny do 2023-12-18

Materiał obudowy: stop aluminium

Materiał klosza: tworzywo sztuczne

Materiał panelu/ramki: stop aluminium

Kanlux BRAVO P/PU panels are components specially selected to ensure greater satisfaction with their use. The aluminium frame, specially selected LED's, reflector, and light diffuser, are just a few of the advantages of Kanlux BRAVO LED P/PU panels. The high light efficiency (120lm/W) is yet another advantage of these panels. Being sure of their quality, we give a 5-year warranty on them. Kanlux BRAVO LED panels do not include a power supply.

5 years Warranty under the terms of the warranty statement, available on our website

The correct LED power supply available in the KANLUX range is required for proper operation

LED panel without power supply included

The product with the code 28024 is designed for alternative-size ceiling systems (625mm x 625mm)

Enclosure material: aluminum alloy

Lampshade material: plastic

Panel/frame material: aluminum alloy

ZASILACZE ► DRIVERS

BRAVO DRIVER 28W	28029	
BRAVO DRIVER 36W	28025	
BRAVO DRIVER 45W	28027	
BRAVO DALI SET 36W	28508	
BRAVO DALI SET 45W	28507	

IN		OUT		
[V]	[Hz]			
220-240V~	50/60			8 cm
	0,75 - 1,5			IP 20



BRAVO DRIVER



BRAVO S/P GRIP



CLIPS BRAVO S/P



SPN BRAVO S/P



ADTR



PSR 100

index	BRAVO S/P GRIP		CLIPS BRAVO S/P		SPN BRAVO S/P		ADTR						PSR 100			
	60x60 / 62x62	120x30	60x60 / 62x62	120x30	60x60 / 62x62	120x30	30x60 (SR)	30x60 (W)	30x60 (B)	60x60 (SR)	60x60 (W)	60x60 (B)	120x30 (SR)	120x30 (W)	120x30 (B)	60x60 / 62x62
	28500	28501	28502	28503	28504	28505	29841	29840	29842	27610	27613	27615	27612	27611	27614	25591
BRAVO P 36W6060NW W	28000	✓	✓		✓					✓	✓	✓				✓
BRAVO PU36W6060NW W	28002	✓	✓		✓					✓	✓	✓				✓
BRAVO PU36W6060NW SR	28003	✓	✓		✓					✓	✓	✓				✓
BRAVO P 36W6060CW W	28006	✓	✓		✓					✓	✓	✓				✓
BRAVO P 45W6060NW W	28008	✓	✓		✓					✓	✓	✓				✓
BRAVO P 45W6060NW SR	28009	✓	✓		✓					✓	✓	✓				✓
BRAVO PU36W6262NW W	28024	✓	✓		✓											✓
BRAVO P 36W12030NW W	28020		✓		✓								✓	✓	✓	
BRAVO PU28W3060NW W	28551	✓	✓		✓		✓	✓	✓							✓

BRAVO S / SU

PANEL LED PODTYNKOWY ► RECESSED-MOUNTED LED PANEL



BRAVO S 40W6060



BRAVO S 40W12030



BRAVO S 40W12030



BRAVO SU40W6060

**LOW
UGR**



UGR
DRIVER [index]

BRAVO S 40W6060NWW	28010	5905339280107	40	4000	4000	110	biały white	28026
BRAVO S 40W6060NWSR	28011	5905339280114	40	4000	4000	110	srebrny silver	28026
BRAVO SU40W6060NWSR	28013	5905339280138	40	4000	4000	110	srebrny silver < 19	28026
BRAVO S 50W6060NWW	28018	5905339280183	50	5000	4000	110	biały white	28028
BRAVO S 50W6060NWSR	28019	5905339280190	50	5000	4000	110	srebrny silver	28028
BRAVO S 40W12030NWW	28022	5905339280220	40	4000	4000	110	biały white	28026

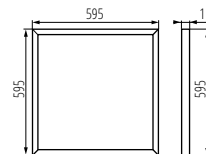

BRAVO S/SU 6060

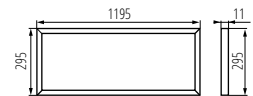

BRAVO S 12030NW



Panelse Kanlux BRAVO S/SU to specjalnie wybrane komponenty dla jeszcze większej satysfakcji z ich użytkowania. Aluminiowa ramka, specjalnie dobrane diody LED, odbłyśnik i dyfuzor rozpraszający światło to tylko niektóre atuty paneli Kanlux BRAVO LED S/SU. Kolejnym atutem tych paneli jest wysoka skuteczność świetlna (100lm/W). Panelse Kanlux BRAVO LED nie posiadają zasilacza w komplecie.

Do prawidłowego działania wymagany jest zasilacz elektroniczny dostępny w ofercie KANLUX.
 Atest PZH: Numer BK/B/1070/01/2018, ważny do 2023-12-18
 Brak zasilacza w komplecie.
 Materiał obudowy: stal
 Materiał klosza: tworzywo sztuczne
 Materiał panelu/ramki: stop aluminium

Kanlux BRAVO S/SU panels are specially selected components for even greater satisfaction with their use. Aluminium framework, specially selected LED diodes, reflector and diffuser distracting light are just some of the assets of Kanlux BRAVO LED S/SU panels. High luminous efficacy (100lm/W) is another asset of these panels. Kanlux BRAVO LED panels do not have any power supply included.

The correct LED power supply available in the KANLUX range is required for proper operation

LED panel without power supply included

Enclosure material: steel
 Lampshade material: plastic
 Panel/frame material: aluminum alloy



BRAVO DRIVER



PSR 100

ZASILACZE ► DRIVERS

BRAVO DRIVER 40W	28026	
BRAVO DRIVER 50W	28028	

IN		OUT		
 220-240V~	 50/60		 8 cm	
	 0,75 - 1,5			 IP 20



BRAVO S/P GRIP



CLIPS BRAVO S/P



SPN BRAVO S/P



ADTR

	index	BRAVO S/P GRIP		CLIPS BRAVO S/P		SPN BRAVO S/P		ADTR					PSR 100	
		60x60 / 62x62	120x30	60x60 / 62x62	120x30	60x60 / 62x62	120x30	60x60 (SR)	60x60 (W)	60x60 (B)	120x30 (SR)	120x30 (W)	120x30 (B)	60x60 / 62x62
BRAVO S 40W6060NW W	28010	✓		✓		✓		✓	✓	✓				✓
BRAVO S 40W6060NW SR	28011	✓		✓		✓		✓	✓	✓				✓
BRAVO SU40W6060NW SR	28013	✓		✓		✓		✓	✓	✓				✓
BRAVO S 50W6060NW W	28018	✓		✓		✓		✓	✓	✓				✓
BRAVO S 50W6060NW SR	28019	✓		✓		✓		✓	✓	✓				✓
BRAVO S 40W12030NW W	28022		✓		✓		✓				✓	✓	✓	

Kanlux

TOWE LED

PANEL LED NATYNKOWY ► SURFACE-MOUNTED LED PANEL



TOWE LED 36W-NW



Kanlux TOWE LED to natynkowa wersja paneli LED. Równomierne rozmieszczenie diod LED wewnątrz oprawy zapewnia jednorodną emisję światła. Szybka instalacja oprawy możliwa jest dzięki czterem otworom umożliwiającym montaż przy pomocy standardowych kołków.

Materiał obudowy: stal
Materiał klosza: tworzywo sztuczne

Kanlux TOWE LED is a facade version of LED panels. Even arrangement of LEDs inside the luminaire ensures homogeneous light emission. Four holes for mounting using standard plugs make the installation of the luminaire quick.

Enclosure material: steel
Lampshade material: plastic

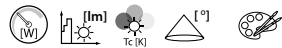

TOWE LED 36W-NW | **25790** | 5905339257901 | 36 | 3200 | 4000 | 110 | biały | white

[V]	[Hz]		[h]		Ra				IP
220-240 AC	50/60	≥15000	20000	≤6° MacAdam	≥80	SMD			20
	[°C]			[mm]	[m]		CE	EAC	
	5÷25			0,75-2,5	0,5m				

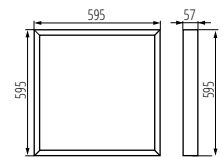

TOWE LED 36W-NW

Kanlux

BRASO LED

PANEL LED PODTYNKOWY ► RECESSED-MOUNTED LED PANEL



BRASO LED 28W 6060 NW



Panele Kanlux BRASO LED charakteryzują się bardzo wysoką skutecznością świetlną bliską 130 lm/W. Ponadto wysoka jakość oprawy pozwala na wydłużenie gwarancji do 5 lat. Zasilacz znajduje się w opakowaniu wraz z panelem.

5 lat Gwarancji na warunkach oświadczenia gwarancyjnego, dostępnego na stronie internetowej

Materiał obudowy: stal
Materiał klosza: tworzywo sztuczne
Materiał panelu/ramki: stop aluminium

Kanlux BRASO LED panels are characterized by very high lighting effectiveness (130 lm/W). Moreover, high quality of the fitting allows prolonging the warranty to 5 years. A power supply unit is in the packaging along with the panel.

5 years Warranty under the terms of the warranty statement, available on our website

Enclosure material: steel
Lampshade material: plastic
Panel/frame material: aluminum alloy

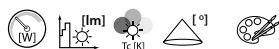

BRASO LED 28W 6060 NW | **32620** | 5905339326201 | 28 | 3600 | 4000 | 110 | biały | white

[V]	[Hz]		[h]		Ra				IP
220-240 AC	50	≥25000	25000	≤6° MacAdam	≥80	SMD			40/20
	[°C]			[mm]	[m]		CE	EAC	
	5÷35			0,75-1	0,5m				

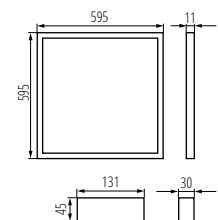

BRASO LED 28W 6060 NW

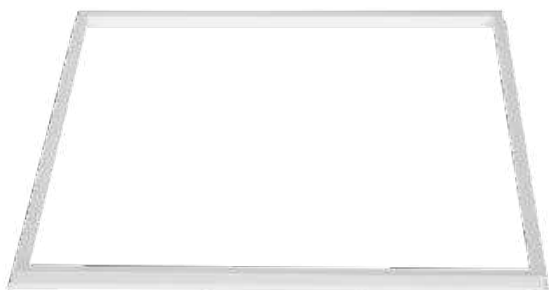

AVAR 6060 40W-NW

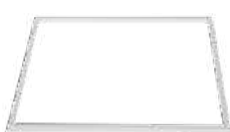

AVAR 6060 40W-CW



AVAR 6262 40W-NW



Panele LED są bardzo popularnym elementem oświetleniowym wewnątrz biurowych. W dużej mierze zastąpiły oprawy rastrowe dzięki swojej trwałości, energooszczędności i estetyce. Kanlux AVAR LED to nowy kierunek paneli LED, którego wyznacznikiem jest nie tylko nowoczesna technologia, ale i sam kształt w formie ramki, która zapewnia mocne i efektowne światło.

AVAR 62x62 przeznaczony jest do alternatywnego rozmiaru systemów sufitowych (625mmx625mm)

Materiał obudowy: stop aluminium

Materiał klosza: tworzywo sztuczne

Materiał panelu/ramki: stop aluminium

LED panels are very popular lighting elements in office interiors. Due to their durability, energy efficiency and aesthetics, they have replaced extent raster luminaires to a large. Kanlux AVAR LED is a new dimension in LED panels distinguished by modern technology and the shape of frame which emits intense and impressive light.

AVAR 62x62 is intended for an alternative size of ceiling systems (625mmx625mm)

Enclosure material: aluminum alloy

Lampshade material: plastic

Panel/frame material: aluminum alloy

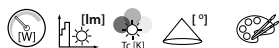

AVAR 6060 40W-NW	26770	5905339267702	40	3600	4000	110	biały white
AVAR 6060 40W-CW	26771	5905339267719	40	3800	6000	110	biały white
AVAR 6060 40W-WWV	26772	5905339267726	40	3400	3000	110	biały white
AVAR 6262 40W-NW	26773	5905339267733	40	3600	4000	110	biały white
AVAR 6262 40W-WWV	26774	5905339267740	40	3400	3000	110	biały white

220-240 AC	50/60	≥15000	25000	≤60° Max/beam	≥80	SMD	IP 20
5+25				0,75	0,5m		



AKCESORIA ▶ ACCESSORIES

AVAR DALI SET 40W	28512	5905339285126	Zestaw zawierający akcesoria i zasilacz umożliwiający komunikację zgodnie z protokołem DALI (28512) Set containing accessories and a power supply unit enabling communication in line with DALI protocol (28512)
-------------------	--------------	---------------	---

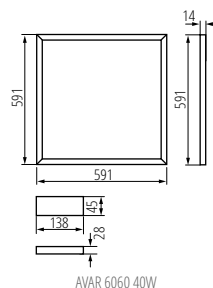

AVAR 6060 40W

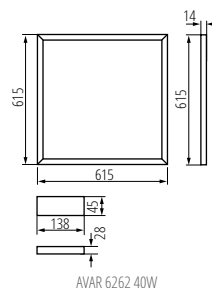

AVAR 6262 40W

Kanlux REGIS

OPRAWA RASTROWA PODTYNKOWA ▶ RECESSED LOUVER FITTING



REGIS 3 EVG 418 PT / REGIS 3WS EVG 418 PT



REGIS 3 EVG 418 PT; REGIS 3WS EVG 418 PT



REGIS 3 OPAL 418 PT; REGIS 3WS OPAL 418 PT



Kanlux REGIS to oprawy rastrowe podtynkowe, które dzięki zaczepom sprężynującym i szybkozłączkom charakteryzują się łatwym i szybkim montażem. Rastry to ciągle bardzo popularne rozwiązanie oświetleniowe wnętrz biurowych czy przemysłowych.

odbłyśnik w kształcie półparaboli / poprzeczki rastra w kształcie „V” / gniazda świetlówek zamaskowane odbłyśnikiem (wyjątkiem jest wersja REGIS 3 OPAL, REGIS 3WS OPAL która ma płytę opal)

w obudowie otwory ułatwiające zasilanie przelotowe

przewód ochronny na rastrze, dodatkowo zabezpieczający przed porażeniem elektrycznym za wyjątkiem wersji REGIS 3 OPAL, REGIS 3WS OPAL.

łatwy montaż rastra na zaczepach sprężynujących

szybkozłączka, do podłączenia zasilania, ułatwia i przyspiesza montaż, statecznik marki OSRAM w klasie A2 malowanie proszkowe

REGIS 3WS wyposażony w statecznik z „ciepłym startem”.

Materiał obudowy: stal

Materiał odbłyśnika: stop aluminium

Kanlux REGIS are raster recessed luminaires that can be mounted quickly and easily with spring clips and quick couplings. Raster lighting is still a very popular solution for office and industrial spaces.

reflector in the shape of a half-parabola / raster crossbars in the shape of “V” / sockets of fluorescent lamps masked with a reflector (exception: version REGIS 3 OPAL, REGIS 3WS OPAL with an opal board)

the casing contains openings facilitating straight through type power supply

protective cable on a raster, additionally securing against electric shock, except the version REGIS 3 OPAL, REGIS 3WS OPAL.

simple assembly of the raster on spring catches

quick coupling, for connection of power supply, facilitates and accelerates assembly, stabilizer by OSRAM in A2 class powder coating

REGIS 3WS equipped with a stabilizer with “warm start”.

Enclosure material: steel

Reflector material: aluminum alloy



REGIS 3 EVG 418 PT	19730	5905339197306	4 x 18	T8	G13	20	biały white
REGIS 3 OPAL 418 PT	19734	5905339197344	4 x 18	T8	G13	40	biały white
REGIS 3WS EVG 418 PT	25710	5905339257109	4 x 18	T8	G13	20	biały white
REGIS 3WS OPAL 418 PT	25713	5905339257130	4 x 18	T8	G13	40	biały white

[V] 220-240 AC	[Hz] 50/60	T8	Light bulb icon	Grounding symbol	House icon	Temperature icon 5+25 °C	Arrow icon	Box icon	Dimensions icon 1+2,5 [mm]
-------------------	---------------	----	-----------------	------------------	------------	-----------------------------	------------	----------	-------------------------------

EVG BALLAST	0,5m	CE	ERC	Kanlux logo
-------------	------	----	-----	-------------

AKCESORIA ▶ ACCESSORIES

CLP-REGIS/PT	72333	5905339723338	CLP-REGIS/PT wspornik montażowy, służy do wbudowania opraw w gips-kartonowym suficie podwieszanym. 4szt w komplecie. CLP-REGIS/PT mounting support, used for building in fittings in a plasterboard suspended ceiling. 4 pcs. in a set.
--------------	-------	---------------	---

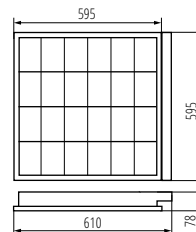

REGIS 3 EVG 418 PT; REGIS 3WS EVG 418 PT

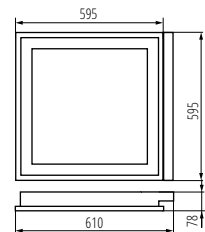

REGIS 3 OPAL 418 PT; REGIS 3WS OPAL 418 PT

Kanlux

REGIS 4LED

OPRAWA RASTROWA PODTYNKOWA ► RECESSED LOUVER FITTING



REGIS 4LED 418 PT



REGIS 4LED 418 PT



REGIS 4LED OPAL 418PT

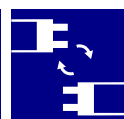

Oprawy Kanlux REGIS 4LED to tradycyjne oprawy rastrowe podtynkowe, przystosowane do świetlówek ledowych T8. Produkowane są w Polsce, z komponentów od polskich dostawców. Rastry to ciągle bardzo popularne rozwiązanie oświetleniowe wnętrz biurowych czy przemysłowych.

oprawy są przeznaczone do źródeł światła T8 LED 220-240 V ~; 50/60Hz z zasilaniem jednostronnym

oprawy przystosowane do zwieszenia na zawieszach

łatwy montaż rastra na zaczepach sprężynujących

malowana proszkowo

Materiał obudowy: stal

Kanlux REGIS 4LED luminaires are traditional raster recessed luminaires adapted to T8 LED fluorescent lamps. They are manufactured in Poland of components provided by Polish suppliers. Raster lighting is still a very popular solution for office and industrial spaces.

the fittings are intended for light sources T8 LED 220-240 V ~; 50/60Hz with one-sided power supply

fittings adapted to suspension on slings

simple assembly of the raster on spring catches

powder coated

Enclosure material: steel



REGIS 4LED OPAL 418PT	19736	5905339197368	4 x max 18	T8 LED	G13	biały white
REGIS 4LED 418 PT	22673	5905339226730	4 x max 18	T8 LED	G13	biały white

[V] 220-240 AC	[Hz] 50/60	T8 LED	ONE SIDE INPUT	Light bulb icon	Ground symbol	IP 20	House icon	Temperature icon 5+25	Speaker icon
Box icon	1+2,5	0,5m	CE	ERC	Kanlux logo and other certifications				

AKCESORIA ► ACCESSORIES

CLP-REGIS/PT	72333	5905339723338	CLP-REGIS/PT wspornik montażowy, służy do wbudowania opraw w gips-kartonowym suficie podwieszanym. 4szt w komplecie. CLP-REGIS/PT mounting support, used for building in fittings in a plasterboard suspended ceiling. 4 pcs. in a set.			
--------------	--------------	---------------	---	--	--	--

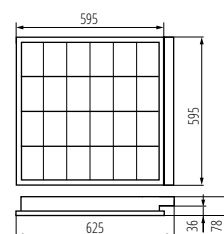

REGIS 4LED 418 PT

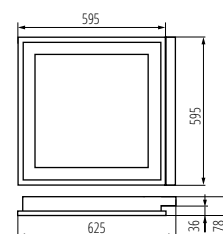

REGIS 4LED OPAL 418PT

Kanlux NOTUS

OPRAWA RASTROWA NATYNKOWA ► SURFACE - MOUNTED LOUVER FITTING



NOTUS 3 EVG 418 NT; NOTUS 3WS EVG 418 NT



NOTUS 3 EVG 236 NT; NOTUS 3WS EVG 236 NT



NOTUS 3 EVG 218 NT



NOTUS 3 EVG 418 NT	19731	5905339197313	4 x 18	T8	G13	biały white
NOTUS 3 EVG 236 NT	19732	5905339197320	2 x 36	T8	G13	biały white
NOTUS 3 EVG 218 NT	19733	5905339197337	2 x 18	T8	G13	biały white
NOTUS 3WS EVG 418 NT	25711	5905339257116	4 x 18	T8	G13	biały white
NOTUS 3WS EVG 236 NT	25712	5905339257123	2 x 36	T8	G13	biały white

[V] 220-240 AC	[Hz] 50/60	T8	Light bulb icon	Grounding symbol	IP 20	House icon	Temperature icon 5+25	Mounting icon	Ballast icon
1+2,5	EVG BALLAST	0,5m	CE	ERC	Kanlux logo and product code				

AKCESORIA ► ACCESSORIES

ROPE-NT 150	07870	5905339078704	ROPE-NT 150 linka stalowa (podwójna) do zwieszania opraw, 2 szt w komplecie ROPE-NT 150 steel rope (double) for suspending fittings, 2 pcs. in a set
ROPE-NT 150 SINGLE	07871	5905339078711	ROPE-NT 150 SINGLE linka stalowa (pojedyncza) do zwieszania opraw, 2 szt w komplecie ROPE-NT 150 SINGLE steel rope (single) for suspending fittings, 2 pcs. in a set

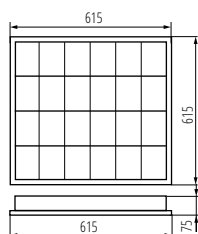

NOTUS 3 EVG 418; NOTUS 3WS EVG 418

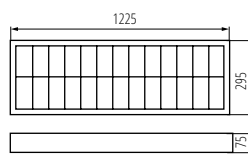

NOTUS 3 EVG 236; NOTUS 3WS EVG 236

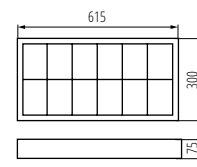

NOTUS 3 EVG 218 NT



Kanlux NOTUS to oprawy rastrowe natynkowe, które charakteryzują się łatwym i szybkim montażem. Rastry to ciągle bardzo popularne rozwiązanie oświetleniowe wnętrz biurowych czy przemysłowych. To za sprawą dobrych parametrów świetlnych przy dobrej cenie, prostej konstrukcji i odporności materiałów z jakich są wykonane.

odbłyśnik w kształcie półparaboli, poprzeczki rastra w kształcie „V” gniazda świetlówek zamaskowane odbłyśnikiem
oprawy przystosowane do zwieszania na zawieszach statecznik marki OSRAM w klasie A2

łatwy montaż rastra na zaczepach sprężynujących
szybkołączka, do podłączenia zasilania, ułatwia i przyspiesza montaż, malowanie proszkowe

NOTUS 3WS wyposażony w statecznik z „ciepłym startem”

Materiał obudowy: stal

Materiał odbłyśnika: stop aluminium

Kanlux NOTUS are raster facade luminaires that can be mounted quickly and easily. Raster lighting is still a very popular solution for office and industrial spaces. It is all due to good lighting parameters at a good price, simple construction and durability of the materials of which they are made.

half-parabolic reflector / V-shaped grille cross-bars
fluorescent lamp sockets concealed with a reflector
light fixtures designed for hanging on slings
Class A2 OSRAM ballast

easy installation of the grille on spring hooks

quick coupling for connecting the power supply, easier and quicker installation, powder coating

NOTUS 3WS equipped with a „warm start” ballast

Enclosure material: steel

Reflector material: aluminum alloy

Kanlux

NOTUS PREMIUM

OPRAWA RASTROWA NATYNKOWA ► SURFACE - MOUNTED LOUVER FITTING



NOTUS PREMIUM 418 NT



NOTUS PREMIUM 418 NT



NOTUS PREMIUM 236 NT



Oprawy Kanlux NOTUS PREMIUM to oprawy rastrowe, natynkowe przeznaczone dla wymagających inwestycji. Od klasycznej wersji różnią się przede wszystkim wyglądem. Ich kształt charakteryzuje się ściętymi bokami i zaokrąglonymi narożnikami, które sprawiają, że oprawy zyskują nowoczesny wygląd.

odbłyśnik w kształcie półparaboli, poprzeczki rastra w kształcie „V”
 gniazda świetlówek zamaskowane odbłyśnikiem
 oprawy przystosowane do zwieszenia na zawieszkiach
 łatwy montaż rastra na zaczepach sprężynujących
 szybkozłączka, do podłączenia zasilania, ułatwia i przyspiesza montaż, malowanie proszkowe, malowanie proszkowe, podwójnie gięte boki, zaokrąglone narożniki
 statecznik marki OSRAM w klasie A2
 Materiał obudowy: stal
 Materiał odbłyśnika: stop aluminium

Kanlux NOTUS PREMIUM are façade raster luminaires designed for demanding investment. They differ from the classic version mainly with their appearance. Their shape is characterised by bevelled edges and rounded corners which give the luminaires the modern appearance.

half-parabolic reflector / V-shaped grille cross-bars
 fluorescent lamp sockets concealed with a reflector
 light fixtures designed for hanging on slings
 easy installation of the grille on spring hooks
 quick coupling for connecting the power supply, easier and quicker installation, powder coating, double-folded side panels, rounded corners
 Class A2 OSRAM ballast
 Enclosure material: steel
 Reflector material: aluminum alloy



NOTUS PREMIUM 236 NT	22290	5905339222909	2 x 36	T8	G13	biały white
NOTUS PREMIUM 418 NT	22291	5905339222916	4 x 18	T8	G13	biały white

[W] 220-240 AC	[Hz] 50/60	T8	Light bulb icon	Grounding symbol	IP 20	House icon	5+25	Spring hook icon	Box icon
1+2,5	EVG BALLAST	0,5m	CE	ERC	Kanlux logo				

AKCESORIA ► ACCESSORIES

ROPE-NT 150	07870	5905339078704	ROPE-NT 150 linka stalowa (podwójna) do zwieszania opraw, 2 szt w komplecie ROPE-NT 150 steel rope (double) for suspending fittings, 2 pcs. in a set
ROPE-NT 150 SINGLE	07871	5905339078711	ROPE-NT 150 SINGLE linka stalowa (pojedyncza) do zwieszania opraw, 2 szt w komplecie ROPE-NT 150 SINGLE steel rope (single) for suspending fittings, 2 pcs. in a set

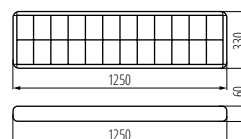

NOTUS PREMIUM 236 NT

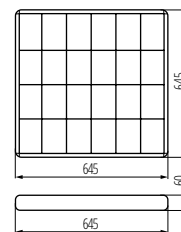

NOTUS PREMIUM 418 NT

NOTUS 4LED

OPRAWA RASTROWA NATYNKOWA ► SURFACE - MOUNTED LOUVER FITTING



NOTUS 4LED 418 NT



NOTUS 4LED 418 NT

NOTUS 4LED 236 NT



NOTUS 4LED 418 NT	22671	5905339226716	4 x max 18	T8 LED	G13	biały white
NOTUS 4LED 236 NT	22672	5905339226723	2 x max 36	T8 LED	G13	biały white

[V] 220-240 AC	[Hz] 50/60	T8 LED	ONE SIDE INPUT	Light bulb icon	Ground symbol	IP 20	House icon	Light fixture icon
Box icon	1+2,5	0,5m	CE	EAC	Kanlux logo and other certifications			

AKCESORIA ► ACCESSORIES

ROPE-NT 150	07870	5905339078704	ROPE-NT 150 linka stalowa (podwójna) do zwieszania opraw, 2 szt w komplecie ROPE-NT 150 steel rope (double) for suspending fittings, 2 pcs. in a set			
ROPE-NT 150 SINGLE	07871	5905339078711	ROPE-NT 150 SINGLE linka stalowa (pojedyncza) do zwieszania opraw, 2 szt w komplecie ROPE-NT 150 SINGLE steel rope (single) for suspending fittings, 2 pcs. in a set			

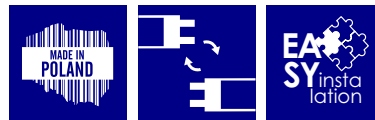

Kanlux NOTUS 4LED to oprawy rastrowe natynkowe, przystosowane do świetlówek ledowych T8. Produkowane są w Polsce, z komponentów od polskich dostawców. Rastry to rozwiązanie oświetleniowe do wnętrz biurowych i przemysłowych. Świetłówki LED przyczyniają się dodatkowo do mniejszego zużycia energii.

oprawy są przeznaczone do źródeł światła T8 LED 220-240 V-; 50/60Hz z zasilaniem jednostronnym

odbłyśnik w kształcie półparaboli, poprzeczki rastra w kształcie „V”

gniazda świetlówek zamaskowane odbłyśnikiem

oprawy przystosowane do zwieszania na zawieszach

łatwy montaż rastra na zaczepach sprężynujących

malowana proszkowo

Materiał obudowy: stal

Materiał odbłyśnika: stop aluminium

Kanlux NOTUS 4LED luminaires are façade raster luminaires adapted to T8 LED fluorescent lamps. They are manufactured in Poland of components provided by Polish suppliers. Raster lighting is a solution for office and industrial interiors. Additionally, LED fluorescent lamps contribute to lower energy consumption.

the fittings are intended for sources T8 LED 220-240 V-; 50/60 Hz with one-sided power supply

half-parabolic reflector / V-shaped grille cross-bars

fluorescent lamp sockets concealed with a reflector

light fixtures designed for hanging on slings

easy installation of the grille on spring hooks

powder coating

Enclosure material: steel

Reflector material: aluminum alloy

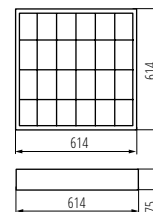

NOTUS 4LED 418 NT

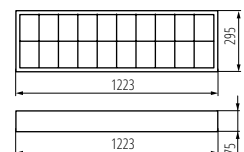

NOTUS 4LED 236 NT



Kanlux

MAH LED N

OPRAWA PYŁOSZCZELNA LED ► LED DUSTPROOF LIGHTING FITTING



MAH-LED N



Kanlux MAH LED N to oprawy hermetyczne przeznaczone dla bardziej wymagających użytkowników. Cechuje je wyjątkowa skuteczność świetlna dochodząca do 105 lm/W i możliwość łączenia w linie nawet 15 opraw (w zależności od modelu), co umożliwia oświetlenie dużych powierzchni.

Materiał obudowy: PC
Materiał klosza: PC

Kanlux MAH LED N are hermetic luminaires designed for more demanding users. They are characterised by unique luminous efficacy reaching 105 lm/W and the possibility of connecting them in lines of even 15 luminaires (depending on the model), which allows for lighting of large spaces.

Enclosure material: PC
Lampshade material: PC

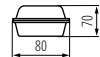
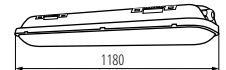

MAH-LED N 40W



MAH-LED N 20W

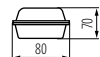
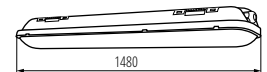

MAH-LED N 50W



MAH-LED N 20W-NW/PC	22603	5905339226037	20	2100	4000	X135/Y100	szary grey
MAH-LED N 40W-NW/PC	22604	5905339226044	40	4200	4000	X135/Y100	szary grey
MAH-LED N 50W-NW/PC	22605	5905339226051	50	5250	4000	X135/Y100	szary grey

[V] 220-240 AC	[Hz] 50	≥15000	30000	ellipse ≤ 6x MacAdam	Ra ≥80	SMD	IP 65	°C -20+40
IK 08	1,5+2,5	0,5m	CE	EAC	Kanlux			

Kanlux

MAH LED HI

OPRAWA PYŁOSZCZELNA LED ► LED DUSTPROOF LIGHTING FITTING

NEW



MAH LED HI



Kanlux MAH LED HI to oprawy hermetyczne przeznaczone dla wymagających użytkowników. Cechuje je wyjątkowa skuteczność świetlna dochodząca do 130 lm/W. Kanlux MAH LED HI to także łatwy, szybki montaż i możliwość łączenia w linie - co umożliwia oświetlenie dużych powierzchni. W oprawach Kanlux MAH LED HI zastosowaliśmy ryflowany klosz, podnoszący strumień świetlny.

5 lat Gwarancji na warunkach oświadczenia gwarancyjnego, dostępnego na stronie internetowej

Materiał obudowy: PC
Materiał klosza: PC

Kanlux MAH LED HI are hermetic luminaires designed for demanding users. They are characterised by exceptional luminous efficacy reaching 105 lm/W. Kanlux MAH LED HI luminaires are easy and quick to mount and can be connected in lines, enabling the illumination of large spaces. In Kanlux MAH LED HI luminaires, we used a grooved lampshade, which increases the luminous flux.

5 years Warranty under the terms of the warranty statement, available on our website

Enclosure material: PC
Lampshade material: PC

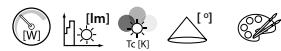

MAH LED HI 19W-NW RYF	22606	5905339226068	19	2400	4000	110	szary grey
MAH LED HI 38W-NW RYF	22607	5905339226075	38	5000	4000	110	szary grey
MAH LED HI 48W-NW RYF	22608	5905339226082	48	6400	4000	110	szary grey

[V] 220-240 AC	[Hz] 50	≥15000	50000	ellipse ≤ 6x MacAdam	Ra ≥80	SMD	IP 65	°C -20+40
IK 08	1,5+2,5	0,5m	CE	EAC	Kanlux			

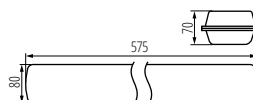

MAH LED HI 19W

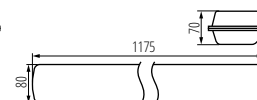

MAH LED HI 38W

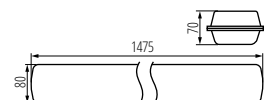

MAH LED HI 48W

KRALA LED

OPRAWA PYŁOSZCZELNA LED ► LED DUSTPROOF LIGHTING FITTING



KRALA LED 45W



KRALA LED 45W NW | **28270** | 5905339282705 | 45 | 5850 | 4000 | 120 | biały | white

[V] 220-240 AC	[Hz] 50/60	cos φ 0,9	⌂ ≥25000	⌚ 30000	⊙ 5850lm	💡 Ra ≥80	⊖ SMD	⊗	⚠️	
IP 65	🏠	❄️ -20÷40	⚙️	IK 08	📏 0,5m	🚫	CE	EAC		

AKCESORIA ► ACCESSORIES

KRALA CORD-2M	28275	Linki stalowe do zwieszenia oprawy 2m - (2 szt w komplecie) Steel cord for hanging the fixture 2m - (2 pcs. included)
KRALA PLUG-1M	28271	Przewód zasilający z wtyczką 1m Power cord with plug 1m
KRALA PP-0,35M	28274	Łącznik giętki 0,35m Flexible connector 0.35m
KRALA PP-1M	28273	Łącznik giętki 1m Flexible connector 1m
KRALA PR-1	28272	Łącznik sztywny Rigid connector

IP
65

HIGH
efficacy

5
WARRANTY
5 years

BRANDED
components

Kanlux KRALA to szczelna oprawa LED, która daje możliwości tworzenia linii świetlnych i tworzenia w nich dowolnych kątów za pomocą giętkiego łącznika. Innowacyjna konstrukcja, wysoka skuteczność świetlna i szybki montaż to tylko niektóre z jej atutów.

Brak przewodu zasilającego w komplecie. Rekomendowany przewód: KRALA PLUG-1M kod 28271

5 lat Gwarancji na warunkach oświadczenia gwarancyjnego, dostępnego na stronie internetowej

Materiał obudowy: tworzywo sztuczne
Materiał klosza: tworzywo sztuczne

Kanlux KRALA is a tight LED fixture, which gives the possibility to create lighting lines and position them at any angle thanks to the flexible connector. Innovative design, high light efficiency and quick installation are just some of its advantages.

No power supply cable included. Recommended cable: KRALA PLUG-1M, code 28271.

5 years Warranty under the terms of the warranty statement, available on our website

Enclosure material: plastic
Lampshade material: plastic



KRALA LED 45W

TP SLIM LED



OPRAWA LINIOWA LED ► LINEAR LED LUMINAIRE



TP SLIM LED 50W



TP SLIM LED 40W

NEW



TP SLIM TW LED

Kanlux TP SLIM TW LED - oprawa okablowana przelotowo, 2 dławiki w oprawie, możliwość łączenia przelotowych opraw.
 Kanlux TP SLIM TW LED - fitting with pass-through installation, 2 chokes in the fitting, possibility of connecting the fittings in-line.



TP SLIM LED 40W-NW	27115	5905339271150	40	4400	4000	X145/Y110	biały white
TP SLIM LED 50W-NW	27116	5905339271167	50	5500	4000	X145/Y110	biały white
TP SLIM TW LED 40W-NW	27117	5905339271174	40	4400	4000	X145/Y110	biały white
TP SLIM TW LED 50W-NW	27118	5905339271181	50	5500	4000	X145/Y110	biały white

[V] 220-240 AC	[Hz] 50/60	[h] ≥20000	[h] 25000	[lm] ellipse ≤ 6x MacAdam	Ra ≥80	SMD	IP 65	[-20+40]	IK 08	[mm] 1-2,5	[m] 0,5m	CE	EAC	Kanlux
-------------------	---------------	---------------	--------------	---------------------------------	-----------	-----	----------	----------	----------	---------------	-------------	----	-----	--------

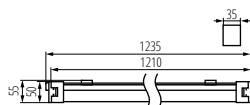

TP SLIM LED 40W-NW

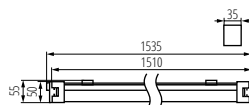

TP SLIM LED 50W-NW

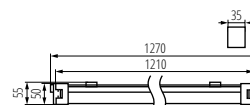

TP SLIM TW LED 40W-NW

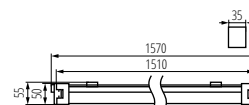

TP SLIM TW LED 50W-NW

up to

110 lm/W

IP 65



Kanlux TP SLIM LED to niewielka oprawa hermetyczna, którą możemy zamontować natynkowo lub w formie zwieszanej. Wygodę montażu zapewniają regulowane uchwyty i szybkozłączki. Dzięki klasie szczelności IP65 i odporności na uderzenia IK 08 mamy możliwość zastosowania oprawy w takich miejscach jak: pomieszczenia przemysłowe, magazyny, parkingi i garaże.

Materiał obudowy: tworzywo sztuczne
 Materiał klasa: tworzywo sztuczne

Kanlux TP SLIM LED is a small hermetic fitting which can be mounted on a surface or in a suspended form. Assembly is convenient thanks to adjustable holders and quick couplings. Owing to IP65 tightness class and IK 08 resistance to impact, you can use the fitting in such places as: industrial rooms, warehouses, car parks and garages.

Enclosure material: plastic
 Lampshade material: plastic

NOME N

OPRAWA LINIOWA LED ► LINEAR LED LUMINAIRE



NOME N LED SMD 18W-NW



NOME N LED SMD 36W-NW



NOME N LED SMD 48W-NW



Oprawy liniowe Kanlux NOME N możemy w prosty sposób połączyć ze sobą tworząc segmenty światła. Oprawy przeznaczone są do oświetlenia pomieszczeń o dużej wilgotności i zapyleniu (IP65), np.: hal produkcyjnych, magazynów, pomieszczeń warsztatowych i podobnych.

Oprawa okablowana przelotowo, 2 dławiki PG11 w oprawie, możliwość łączenia przelotowego opraw

Materiał obudowy: PC

Materiał klosza: PC

Kanlux NOME N linear luminaires can be easily connected to create light segments. The luminaires are designed for lighting rooms of high humidity and dustiness (IP65), e.g.: production halls, storehouses, workshops, etc.

Fitting with pass-through installation, 2 chokes PG11 in the fitting, possibility of connecting the fittings in-line

Enclosure material: PC

Lampshade material: PC

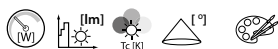

NOME N LED SMD 18W-NW	25493	5905339254931	18	1800	4000	120	biały white
NOME N LED SMD 36W-NW	25494	5905339254948	36	3600	4000	120	biały white
NOME N LED SMD 48W-NW	25495	5905339254955	48	4800	4000	120	biały white

[V] 220-240 AC	[Hz] 50/60	[h] ≥20000	[h] 25000	[lm] ≤60 MacAdam	Ra ≥80	SMD
[mm] 1+2,5	[m] 0,5m	IP 65	[°C] -20+40	[°] [°]	[°]	Kanlux
[mm] 1+2,5	[m] 0,5m	CE	EAC	[°]	[°]	[°]



NOME N LED SMD 18W

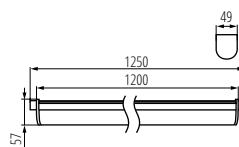

NOME N LED SMD 36W

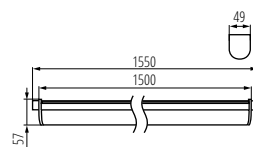

NOME N LED SMD 48W

MAH PLUS 4LED

OPRAWA PYŁOSZCZELNA POD TUBY LED ▶ DUST-PROOF LED TUBE LIGHT FITTING



MAH PLUS-236/4LED/PC

NEW



MAH PLUS-136/4LED/PC



MAH PLUS-158/4LED/PC



Kanlux MAH PLUS 4LED to ledowe odpowiedniki popularnych opraw. Ich głównym atutem jest fakt, że można zastosować w nich ledowe źródła światła T8 o długościach 1200 mm lub 1500 mm. Jest to doskonale rozwiązanie dla zastosowań przemysłowych.

oprawy MAH PLUS 4LED/PC są przeznaczone do źródeł T8 LED 220-240 V-; 50/60 Hz z zasilaniem jednostronnym

Atest PZH: Numer BK/K/0024/01/2019, ważny do 2024-03-12

Materiał obudowy: tworzywo sztuczne

Materiał klosza: PC

Materiał zapinek: tworzywo sztuczne

Kanlux MAH PLUS 4LED are LED equivalents of popular luminaires. Their core asset consists in the fact that they can use T8 LED light sources that are 1200 mm or 1500 mm long. This solution is perfect for industrial use.

MAH PLUS 4 LEDs/PC light fixtures are designed for T8 LED 220-240 V-; 50/60 Hz light sources with one-sided power supply

Enclosure material: plastic

Lampshade material: PC

Clasp material: plastic



MAH PLUS-236/4LED/PC	22800	5905339228000	2 x max 36	T8 LED	G13	szary grey
MAH PLUS-258/4LED/PC	22801	5905339228017	2 x max 58	T8 LED	G13	szary grey
MAH PLUS-136/4LED/PC	22802	5905339228024	max 36	T8 LED	G13	szary grey
MAH PLUS-158/4LED/PC	22803	5905339228031	max 58	T8 LED	G13	szary grey

[V] 220-240 AC	[Hz] 50/60	T8 LED	IP 65	5+25	ONE SIDE INPUT	0,5m	CE	EAC	Kanlux
--------------------------	----------------------	--------	----------	------	----------------	------	----	-----	--------

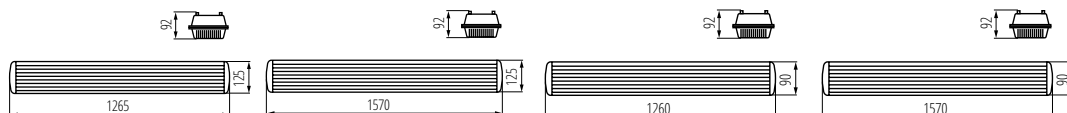

MAH PLUS-236/4LED/PC

MAH PLUS-258/4LED/PC

MAH PLUS-136/4LED/PC

MAH PLUS-158/4LED/PC

MAH PLUS

OPRAWA PYŁOSZCZELNA ► DUSTPROOF LIGHTING FITTING



MAH PLUS-118-ABS/PC



MAH PLUS-158-ABS/PC



MAH PLUS-258-ABS



MAH PLUS-118-ABS/PC	18515	5905339185150	18	T8	G13	szary grey
MAH PLUS-218-ABS/PC	18517	5905339185174	2 x 18	T8	G13	szary grey
MAH PLUS-136-ABS/PC	18519	5905339185198	36	T8	G13	szary grey
MAH PLUS-236-ABS/PC	18521	5905339185211	2 x 36	T8	G13	szary grey
MAH PLUS-158-ABS/PC	18523	5905339185235	58	T8	G13	szary grey
MAH PLUS-258-ABS/PC	18525	5905339185259	2 x 58	T8	G13	szary grey

[V] 220-240 AC	[Hz] 50/60	T8	IP 65	5+25	1+2,5	EVG BALLAST	0,5m	CE	EMC	Kanlux
-------------------	---------------	----	----------	------	-------	-------------	------	----	-----	--------

AKCESORIA ► ACCESSORIES

GL-MAH-136 PLUS-PC	18589	5905339185891	Klosz oprawy MAH, GL-MAH-136 PLUS-PC, (18589) Fitting shade MAH, GL-MAH-136 PLUS-PC, (18589)
GL-MAH-158 PLUS-PC	18596	5905339185969	Klosz oprawy MAH, GL-MAH-158 PLUS-PC, (18596) Fitting shade MAH, GL-MAH-158 PLUS-PC, (18596)
GL-MAH-218 PLUS-PC	18587	5905339185877	Klosz oprawy MAH, GL-MAH-218 PLUS-PC, (18587) Fitting shade MAH, GL-MAH-218 PLUS-PC, (18587)
CL-MAH PLUS	18593	5905339185938	Klipsy oprawy MAH, CL-MAH PLUS, (18593) Fitting clip MAH, CL-MAH PLUS, (18593)
CL-MAH PLUS-INOX	18594	5905339185945	Klipsy oprawy MAH, CL-MAH PLUS-INOX, (18594) Fitting clip MAH, CL-MAH PLUS-INOX, (18594)
ROPE-NT 150	07870	5905339078704	ROPE-NT 150 linka stalowa (podwójna) do zwieszania opraw, 2 szt w komplecie ROPE-NT 150 steel rope (double) for suspending fittings, 2 pcs. in a set
ROPE-NT 150 SINGLE	07871	5905339078711	ROPE-NT 150 SINGLE linka stalowa (pojedyncza) do zwieszania opraw, 2 szt w komplecie ROPE-NT 150 SINGLE steel rope (single) for suspending fittings, 2 pcs. in a set



Oprawy pyłoszczelne Kanlux MAH PLUS doskonale sprawdzają się jako oświetlenie tuneli, hal przemysłowych, garaży, pomieszczeń warsztatowych, wiat składowych lub magazynów. Wysoka klasa szczelności IP65 sprawia, że oprawy te można montować w miejscach bezpośrednio narażonych na działanie czynników atmosferycznych.

Łatwy montaż oprawy do podłoża przy użyciu dołączonych zatraskowych uchwytów mocujących

podwieszana płyta montażowa ułatwiająca podłączenie i serwis oprawy

uszczelniający dławik, służący do wprowadzenia przewodu zasilającego

Materiał obudowy: tworzywo sztuczne

Materiał zapinek: tworzywo sztuczne

Materiał uchwytu: metal

Kanlux MAH PLUS are perfect as lighting of tunnels, industrial halls, garages, workshops, storage sheds or storehouses. Owing to the high class of tightness (IP65), the luminaires can be mounted in places directly exposed to weather conditions.

easy installation of the light fixture using the supplied snap-on mounting brackets

suspended mounting plate for easier connection and maintenance of the light fixture

barrier gland for inserting a power cable

Enclosure material: plastic

Clasp material: plastic

Handle material: Metal

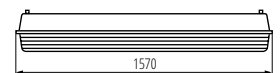
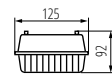

MAH PLUS-258-ABS/PC

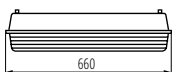

MAH PLUS-118-ABS

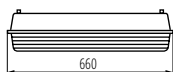
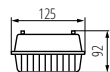

MAH PLUS-218-ABS

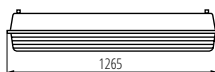

MAH PLUS-136-ABS

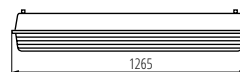
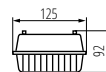

MAH PLUS-236-ABS

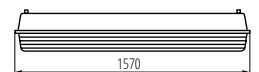

MAH PLUS-158-ABS

MEBA 4LED

OPRAWA LINIOWA POD TUBY LED T8 ▶ T8 LED TUBE LINEAR FITTINGS



MEBA 4LED 2X60 PS



MEBA 4LED 2X60 OP PS



MEBA 4LED 2X120 PS



MEBA 4LED 2X120 OP PS



MEBA 4LED 2X150 OP PS



MEBA 4LED 2X60 PS	26960	5905339269607	2 x max 18	T8 LED	G13	biały white
MEBA 4LED 2X120 PS	26961	5905339269614	2 x max 36	T8 LED	G13	biały white
MEBA 4LED 2X60 OP PS	26963	5905339269638	2 x max 18	T8 LED	G13	biały white
MEBA 4LED 2X120 OP PS	26964	5905339269645	2 x max 36	T8 LED	G13	biały white
MEBA 4LED 2X150 OP PS	26965	5905339269652	2 x max 58	T8 LED	G13	biały white

[V] 220-240 AC	[Hz] 50/60	T8 LED	IP 20	5+25	0,5m	CE	ERAC	Kanlux G
ONE SIDE INPUT	1-2,5							

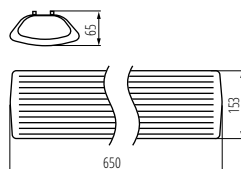

MEBA 4LED 2X60

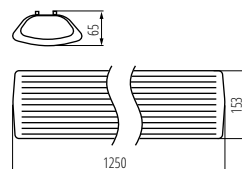

MEBA 4LED 2X120

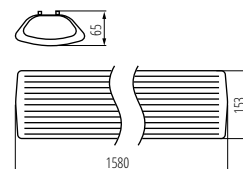

MEBA 4LED 2X150

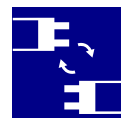

Kanlux MEBA 4LED to ledowa wersja oprawy liniowej Kanlux MEBA. Zastosowane w niej tuby ledowe T8 gwarantują oszczędniejsze i dłuższe działanie, co pozytywnie przekłada się na ich komfort użytkowania w salonach kosmetycznych, fryzjerskich i pomieszczeniach biurowych.

oprawy są przeznaczone do źródeł T8 LED 220-240 V-; 50/60 Hz z zasilaniem jednostronnym

Materiał obudowy: tworzywo sztuczne, stal
Materiał klosza: PS

Kanlux MEBA 4LED is a LED version of Kanlux MEBA linear luminaire. T8 LED tubes used in it guarantee more economical and longer operation, which positively translates into the comfort of use in beauty and hairdresser salons, and office spaces.

the fittings are intended for sources T8 LED 220-240 V-; 50/60 Hz with one-sided power supply

Enclosure material: plastic, steel
Lampshade material: PS

Kanlux

ALDO 4LED

OPRAWA LINIOWA POD TUBY LED T8 ▶ T8 LED TUBE LINEAR FITTINGS

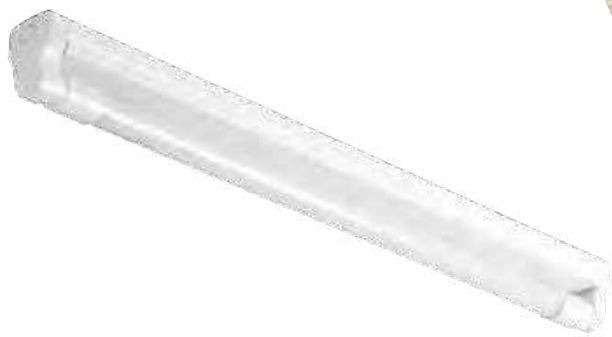

ALDO 4LED 1X60; 1X120; 1X150

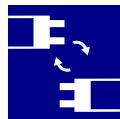

Kanlux ALDO 4LED to rodzina belek oświetleniowych przystosowanych do świetlówek ledowych T8. Są to oprawy ścienna-sufitowe charakteryzujące się nowoczesnym, opływowym kształtem, przez co dyskretnie wpasują się w każdą aranżację wnętrza.

Oprawy są przeznaczone do źródeł T8 LED 220-240 V-; 50/60 Hz z zasilaniem jednostronnym

Materiał obudowy: metal, tworzywo sztuczne

Kanlux ALDO 4LED are a family of batten luminaires adapted to T8 LED fluorescent lamps. They are wall and ceiling luminaires characterised by modern, streamlined shape so they fit discreetly in each interior arrangement.

The fittings are intended for sources T8 LED 220-240 V-; 50/60 Hz with one-sided power supply

Enclosure material: Metal, plastic



ALDO 4LED 2X120



ALDO 4LED 2X150



ALDO 4LED 1X60	26360	5905339263605	max 18	T8 LED	G13	biały white
ALDO 4LED 1X120	26361	5905339263612	max 36	T8 LED	G13	biały white
ALDO 4LED 1X150	26362	5905339263629	max 58	T8 LED	G13	biały white
ALDO 4LED 2X120	26364	5905339263643	2 x max 36	T8 LED	G13	biały white
ALDO 4LED 2X150	26365	5905339263650	2 x max 58	T8 LED	G13	biały white

[V] 220-240 AC	[Hz] 50/60	T8 LED		IP 20		 5+25		 0,5-2,5	 ONE SIDE INPUT
 0,5m		CE	ERC						

ALDO 4LED

OPRAWA LINIOWA POD TUBY LED T8 ► T8 LED TUBE LINEAR FITTINGS

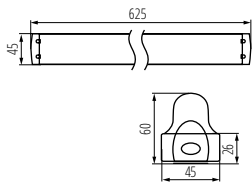

ALDO 4LED 1X60

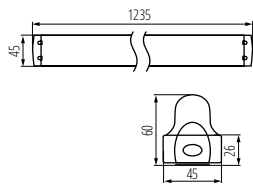

ALDO 4LED 1X120

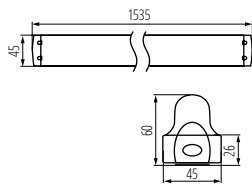

ALDO 4LED 1X150

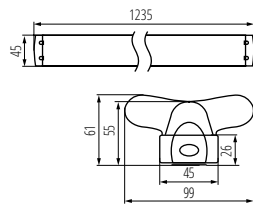

ALDO 4LED 2X120

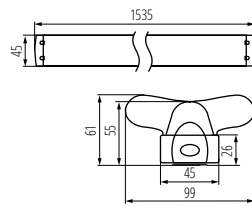

ALDO 4LED 2X150





BENO 18W NW-L-GR; BENO 18W NW-L-SE GR



BENO 18W NW-O-W; BENO 18W NW-O-SE W



BENO 18W NW-O-GR; BENO 18W NW-O-SE GR



BENO 18W NW-L-W; BENO 18W NW-L-SE W



BENO 18W NW-L-GR; BENO 18W NW-L-SE GR



BENO 24W NW-O-W; BENO 24W NW-O-SE W



BENO 24W NW-O-GR; BENO 24W NW-O-SE GR



BENO 24W NW-L-W; BENO 24W NW-L-SE W



BENO 24W NW-L-GR; BENO 24W NW-L-SE GR



BENO 18W NW-O-W	32940	5905339329400	18	1550	4000	biały white	
BENO 18W NW-O-GR	32941	5905339329417	18	1550	4000	grafitowy graphite	
BENO 18W NW-L-W	32942	5905339329424	18	1550	4000	biały white	
BENO 18W NW-L-GR	32943	5905339329431	18	1550	4000	grafitowy graphite	
BENO 18W NW-O-SE W	32944	5905339329448	18	1550	4000	biały white	mikrofalowy microwave
BENO 18W NW-O-SE GR	32945	5905339329455	18	1550	4000	grafitowy graphite	mikrofalowy microwave
BENO 18W NW-L-SE W	32946	5905339329462	18	1550	4000	biały white	mikrofalowy microwave
BENO 18W NW-L-SE GR	32947	5905339329479	18	1550	4000	grafitowy graphite	mikrofalowy microwave
BENO 24W NW-O-W	33340	5905339333407	24	2060	4000	biały white	
BENO 24W NW-O-GR	33341	5905339333414	24	1920	4000	grafitowy graphite	
BENO 24W NW-L-W	33342	5905339333421	24	2060	4000	biały white	
BENO 24W NW-L-GR	33343	5905339333438	24	1920	4000	grafitowy graphite	
BENO 24W NW-O-SE W	33344	5905339333445	24	2060	4000	biały white	mikrofalowy microwave
BENO 24W NW-O-SE GR	33345	5905339333452	24	1920	4000	grafitowy graphite	mikrofalowy microwave
BENO 24W NW-L-SE W	33346	5905339333469	24	2060	4000	biały white	mikrofalowy microwave
BENO 24W NW-L-SE GR	33347	5905339333476	24	1920	4000	grafitowy graphite	mikrofalowy microwave

[V] 220-240 AC	[Hz] 50	[°] 110	[h] ≥20000	[h] 20000	[lm] ≤ 60 Mac/km	Ra ≥80	SMD	IP 54
[°C] -15+35	[mm] 0,5+1,5	[m] 0,5m	[m] 0,5m	[m] 0,5m	[m] 0,5m	[m] 0,5m	[m] 0,5m	[m] 0,5m

BENO LED

PLAFONIERA LED ► CEILING-MOUNTED LED LIGHT FITTING



Oprawy Kanlux BENO to unikatowa konstrukcja i wyjątkowy efekt świetlny. Zostały stworzone przez projektantów Kanlux, dlatego ich wzory zostały przez nas zastrzeżone w urzędzie patentowym. Kanlux BENO LED to wysoka odporność na warunki atmosferyczne - dlatego możemy stosować je wewnątrz domu jak i na zewnątrz. To również szybki i łatwy montaż na suficie lub ścianie oraz czujnik ruchu z możliwością regulacji. Kanlux BENO LED jest oprawą multifunkcyjną, którą ze względu na jej aspekty techniczne, możemy zastosować praktycznie w każdym miejscu. Ponadto jej design jest unikatowy i stanie się ona ozdobą każdego miejsca, w którym ją umieścimy.

Materiał obudowy: tworzywo sztuczne

Materiał klosza: tworzywo sztuczne

Kanlux BENO luminaires that's unique design and unique light effect. They were created on the basis of individual order of Kanlux, and their designs were registered by us at the patent office. Kanlux BENO LED also provides high weather resistance (IP54), quick and easy installation on the ceiling or wall, and Beno is equipped with the adjustable movement sensor. Kanlux BENO LED is a multifunctional fitting, which due to its design and its technical aspects, we can apply practically anywhere.

Enclosure material: plastic

Lampshade material: plastic

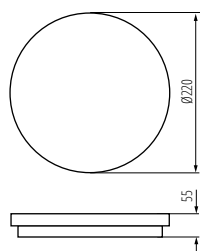

BENO 18W NW-0; SE

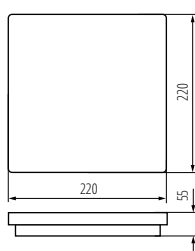

BENO 18W NW-L; SE

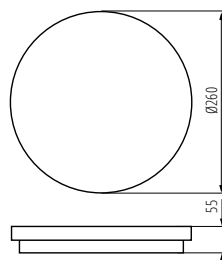

BENO 24W NW-0; SE

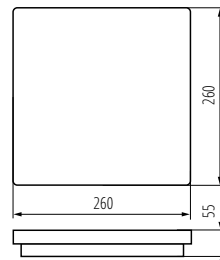

BENO 24W NW-L; SE

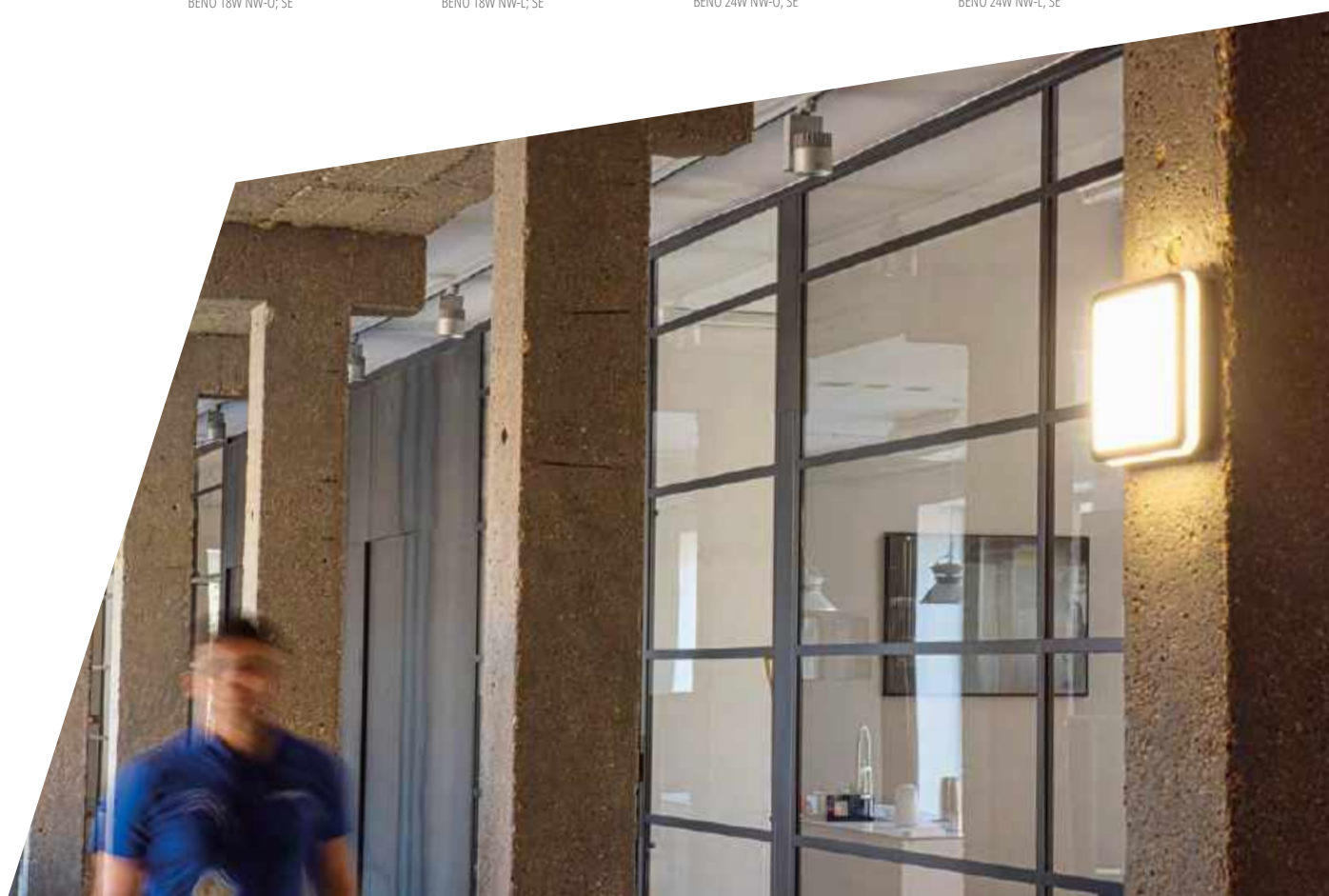

VARSO LED

PLAFONIERA LED ► CEILING-MOUNTED LED LIGHT FITTING



VARSO LED 18W-O; VARSO LED 18W-O-SE



VARSO LED 18W-L; VARSO LED 18W-L-SE



VARSO LED 24W-O; VARSO LED 24W-O-SE



VARSO HI 36W-NW-L; VARSO HI 36W-NW-L-SE

NEW



Kanlux VARSO LED to rodzina plafonier hermetycznych ze zintegrowanym źródłem światła LED. Jest to znakomita propozycja zarówno dla inwestycji (spółdzielnie mieszkaniowe, hotele) jak i indywidualnych gospodarstw domowych gdzie potrzebna jest podwyższona odporność na wilgoć (IP54). Dla oświetlenia szczególnie dużych powierzchni proponujemy Kanlux VARSO HI o mocy 36 watów, których strumień świetlny wynosi aż 3600 lumenów. Pamiętaj, że dostępne są również wersje Kanlux VARSO z czujnikami ruchu (SE).

Atest PZH: Numer BK/K/0352/01/2018, ważny do 2023-05-30

VARSO LED + SE - wersja z czujnikiem ruchu

Materiał obudowy: tworzywo sztuczne

Materiał klosza: tworzywo sztuczne

Kanlux VARSO LED is a family of hermetic ceiling light fixtures with an integrated LED light source. It is a great choice both for developments (housing co-operatives, hotels) and individual households where increased resistance to humidity (IP54) is needed. For lighting particularly large spaces, we recommend 36W Kanlux VARSO HI with a luminous flux up to 3600 lm. Keep in mind that we also offer Kanlux VARSO fixtures with motion sensors (SE).

PZH attestation: Number BK/K/0352/01/2018, valid until 2023-05-30

VARSO LED + SE - version with a motion sensor

Enclosure material: plastic

Lampshade material: plastic



Model	Code	Part No.	Wattage	Beam Angle	Light Output [lm]	Color Temp. [K]	Color Rendering [Ra]	Material	Features
VARSO LED 18W-WW-O	26440	5905339264404	18	1620	3000	biały white			
VARSO LED 18W-NW-O	26441	5905339264411	18	1700	4000	biały white			
VARSO LED 18W-WW-L	26442	5905339264428	18	1620	3000	biały white			
VARSO LED 18W-NW-L	26443	5905339264435	18	1700	4000	biały white			
VARSO LED 24W-WW-O	26444	5905339264442	24	2160	3000	biały white			
VARSO LED 24W-NW-O	26445	5905339264459	24	2280	4000	biały white			
VARSO LED 24W-WW-L	26446	5905339264466	24	2160	3000	biały white			
VARSO LED 24W-NW-L	26447	5905339264473	24	2280	4000	biały white			
VARSO HI 36W-NW-O	26448	5905339264480	36	3600	4000	biały white			
VARSO HI 36W-NW-L	26449	5905339264497	36	3600	4000	biały white			
VARSO LED 18W-NW-L-SE	26980	5905339269805	18	1700	4000	biały white	mikrofalowy microwave		
VARSO LED 18W-NW-O-SE	26981	5905339269812	18	1700	4000	biały white	mikrofalowy microwave		
VARSO LED 24W-NW-L-SE	26983	5905339269836	24	2280	4000	biały white	mikrofalowy microwave		
VARSO LED 24W-NW-O-SE	26984	5905339269843	24	2280	4000	biały white	mikrofalowy microwave		
VARSO HI 36W-NW-O-SE	26985	5905339269850	36	3600	4000	biały white	mikrofalowy microwave		
VARSO HI 36W-NW-L-SE	26986	5905339269867	36	3600	4000	biały white	mikrofalowy microwave		

[V] 220-240 AC	[Hz] 50	[°] 120	[lm] ≥20000	[h] 20000	[Ra] ≥80	[SMD]	[IP] IP 54	[House]
[Temp] -20+35	[Mount]	[Depth] 0,5-2,5	[Beam]0,5m	[Sensor]	[CE]	[EAC]	[Kanlux]	[Warranty]

Kanlux

VARSO LED

PLAFONIERA LED ► CEILING-MOUNTED LED LIGHT FITTING



VARSO LED 18W-O; VARSO LED 18W-O-SE



VARSO LED 18W-L; VARSO LED 18W-L-SE



VARSO LED 24W-O; VARSO LED 24W-O-SE
VARSO HI 36W-NW-O; VARSO HI 36W-NW-O-SE



VARSO LED 24W-L; VARSO LED 24W-L-SE
VARSO HI 36W-NW-L; VARSO HI 36W-NW-L-SE

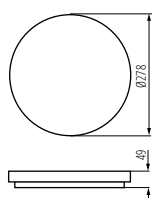

VARSO LED 18W-O; VARSO LED 18W-O-SE

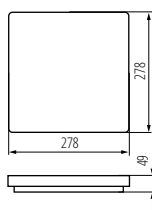

VARSO LED 18W-L; VARSO LED 18W-L-SE

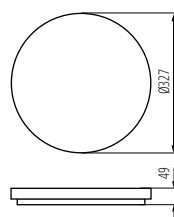

VARSO LED 24W-O; VARSO LED 24W-O-SE
VARSO HI 36W-NW-O; VARSO HI 36W-NW-O-SE

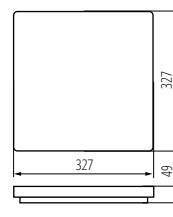

VARSO LED 24W-L; VARSO LED 24W-L-SE
VARSO HI 36W-NW-L; VARSO HI 36W-NW-L-SE



ORTE LED



PLAFONIERA LED ► CEILING-MOUNTED LED LIGHT FITTING



ORTE LED 18W-NW-O; 18W-O-SE



ORTE LED 18W-O, ORTE LED 18W-O-SE



ORTE LED 24W-O, ORTE LED 24W-O-SE



ORTE LED 18W-NW-O	29160	5905339291608	18	1600	4000	biały white
ORTE LED 24W-NW-O	29161	5905339291615	24	2200	4000	biały white
ORTE LED 18W-NW-O-SE	29162	5905339291622	18	1600	4000	biały white mikrofalowy microwave
ORTE LED 24W-NW-O-SE	29163	5905339291639	24	2200	4000	biały white mikrofalowy microwave

[V] 220-240 AC	[Hz] 50/60	[°] 120	[h] ≥20000	[h] 20000	[lm] ≤60 Mackam	Ra ≥80	SMD	IP 54
[°C] -20÷35	[mm] 0,75+2,5	[mm] 0,5m	CE	ERC				



Kanlux ORTE LED to nowa rodzina plafonier gdzie szczególną uwagę zwróciliśmy na design i łatwość instalacji. Dla dodatkowej wygody proponujemy Wam również wersje z czujnikiem ruchu.

Materiał obudowy: tworzywo sztuczne
Materiał klosza: tworzywo sztuczne



Kanlux ORTE LED is a new family of wall and ceiling fixtures in which particular attention has been paid to design and ease of installation. For added convenience, you can also choose from various motion detector versions.

Enclosure material: plastic
Lampshade material: plastic

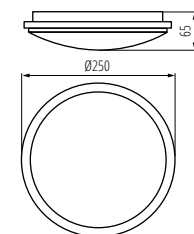

ORTE LED 18W-O, ORTE LED 18W-O-SE

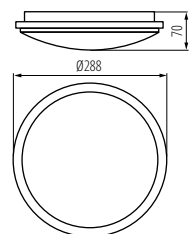

ORTE LED 24W-O, ORTE LED 24W-O-SE



Kanlux

BIGGE LED

PLAFONIERA LED ► CEILING-MOUNTED LED LIGHT FITTING



BIGGE LED 42W-NW-O



Kanlux BIGGE LED to seria plafonier o dużych mocach i rozmiarach. Świetnie sprawdzą się jako oświetlenie ciągów komunikacyjnych, klatek schodowych i korytarzy, a także dużych, otwartych przestrzeni.

Materiał obudowy: stal
Materiał klosza: tworzywo sztuczne

Kanlux BIGGE LED is a series of large, high-power and wall and ceiling fixtures. They are perfect for illuminating communication routes, staircases and corridors, as well as large, open spaces.

Enclosure material: steel
Lampshade material: plastic

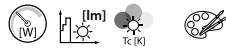

BIGGE LED 42W-NW-O	28721	5905339287212	42	2700	4000	biały white
BIGGE LED 42W-NW-L	28723	5905339287236	42	2700	4000	biały white

[V]	[Hz]	[°]	[h]	[lm]	Ra	SMD	IP	CE	ERAC	Other icons
220-240 AC	50/60	120	≥20000	25000	≥80	SMD	IP 20	CE	ERAC	Other icons

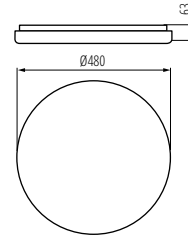

BIGGE LED 42W-O

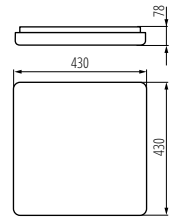

BIGGE LED 42W-L

Kanlux

SANSO LED

PLAFONIERA LED ► CEILING-MOUNTED LED LIGHT FITTING



SANSO LED 15W-NW-SE



Plafoniera Kanlux SANSO LED z wbudowanym czujnikiem ruchu PIR pozwala na dostosowanie jej do własnych potrzeb. Charakteryzuje się ona także podwyższoną szczelnością (IP 44), dzięki czemu jej wnętrze chronione jest przed kurzem i pyłem.

Materiał obudowy: PC
Materiał klosza: PC

Kanlux SANSO LED ceiling luminaire with a built-in motion detector PIR allows for its customisation depending on your needs. It is also characterised by increased tightness (IP 44) so its inside is protected against dust and dirt.

Enclosure material: PC
Lampshade material: PC



SANSO LED 15W-NW-SE	26520	5905339265203	15	1250	4000	biały white	PIR
---------------------	--------------	---------------	----	------	------	---------------	-----

[V]	[Hz]	[°]	[h]	[lm]	Ra	SMD	IP	CE	ERAC	Other icons
220-240 AC	50/60	120	≥10000	15000	≥80	SMD	IP 44	CE	ERAC	Other icons

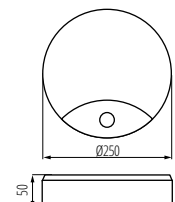

SANSO LED 15W-NW-SE

Kanlux

PORTOS LED

PLAFONIERA LED ► CEILING-MOUNTED LED LIGHT FITTING



PORTOS LED; PORTOS LED SE



Kanlux PORTOS LED to oprawa elewacyjna. Dzięki niej oświetlisz elewację, a także podświetlisz numer posesji. Kanlux PORTOS LED w swojej uniwersalnej formie doskonale pasuje do każdej powierzchni. Idealnie gładkim ścianom dodaje charakter, a na elewacjach takich jak cegła, deska elewacyjna czy tynk strukturalny, podkreśla kształt i wydobywa ich wyjątkowość. Kanlux PORTOS LED to wytrzymała i odporna na działanie czynników zewnętrznych oprawa, którą zastosujesz zarówno w pomieszczeniach, jak i na zewnątrz, bez obaw, że wilgoć i pył zmniejszą jej wydajność pracy. Wersja oprawy Kanlux PORTOS LED SE posiada wbudowany czujnik zmierzchu.

Kanlux PORTOS LED is a facade luminaire. Thanks to it, you can illuminate the facade and highlight the property number. Kanlux PORTOS LED in its universal form perfectly fits any surface. Perfectly smooth walls add character, and on facades such as brick, cladding board or structural plaster, it emphasizes the shape and brings out their uniqueness. Kanlux PORTOS LED is a durable and resistant to external factors luminaire that can be used both indoors and outdoors, without fear that moisture and dust will reduce its work efficiency. The Kanlux PORTOS LED SE version of the luminaire has a built-in dusk sensor.



PORTOS LED	29070	5905339290700	5	500	4000	biały white	≥10000
PORTOS LED SE	29071	5905339290717	5	450	4000	biały white	≥15000 zmierzchu dusk

[V]	[Hz]	[°]	[h]	[lm]	Ra	[SMD]	[IP]	[house]
220-240 AC	50	120	30000	≤ 6x/Maxdłm	≥80	SMD	IP 54	house
[°C]	[mm]	[mm]	[mm]	[m]	[m]	[m]	[m]	[m]
-10+35	0,5+1,5	0,5m	0,5m	0,5m	0,5m	0,5m	0,5m	0,5m

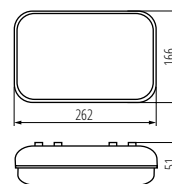

PORTOS LED; SE

Kanlux

FOGLER LED

PLAFONIERA LED ► CEILING-MOUNTED LED LIGHT FITTING



FOGLER LED 14W-NW



Plafoniera Kanlux FOGLER LED z czujnikiem ruchu, znakomicie sprawdzi się przy oświetleniu klatek schodowych, pomieszczeń technicznych w budynkach wielorodzinnych, schowków, piwnic, a także garaży i podjazdów w domach jednorodzinnych.

Materiał obudowy: stal
Materiał klosza: PC

Kanlux FOGLER LED ceiling light fixture with motion detector is a great solution for lighting staircases, technical rooms in multi-family buildings, storage rooms, basements, garages and driveways in detached houses.

Enclosure material: steel
Lampshade material: PC



FOGLER LED 14W-NW	18121	5905339181213	14	800	4000	biały white	PIR
-------------------	--------------	---------------	----	-----	------	---------------	-----

[V]	[Hz]	[°]	[h]	[lm]	Ra	[SMD]	[IP]	[house]
220-240 AC	50/60	110	20000	≤ 6x/Maxdłm	≥80	SMD	IP 20	house
[°C]	[mm]	[mm]	[mm]	[m]	[m]	[m]	[m]	[m]
5+25	0,5-2,5	max 6	360	10-5	PIR	5-2000	0,5m	0,5m

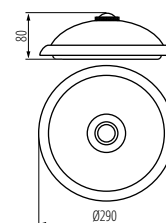

FOGLER LED 14W-NW

Kanlux

FOGLER DL

PLAFONIERA Z WYMIENNYM ŹRÓDŁEM ŚWIATŁA ► CEILING-MOUNTED LIGHT FITTING WITH REPLACEABLE LIGHT SOURCE



FOGLER DL-2400



FOGLER DL-2400 | 18120 | 5905339181206 | 2 x max 40 | GLS/CFL/LED | E27 | biały | white

[V] 220-240 AC	[Hz] 50/60	⏚	IP 20	🏠	🌡️ 5+25	📐	📦	📏 1-2,5	📏 max 8
H360/V120	(s) - (min) 12-5	PIR	🌟 3-2000	📏 0,5m	💡	CE	ERC		



Plafoniera Kanlux FOGLER DL z wymiennym źródłem światła doskonale sprawdzi się na klatkach schodowych, piwnicach, strychach i innych tego typu pomieszczeniach. Wbudowany czujnik z maksymalnym kątem (360°) wykrywania ruchu, gwarantuje, że oprawa włączy się dokładnie wtedy, kiedy potrzebujemy światła.

wyposażona w czujnik ruchu
maksymalny horyzontalny kąt działania czujnika ruchu wynoszący 360°
maksymalny wertykalny kąt działania czujnika ruchu wynoszący 120°
możliwość regulacji czasu świecenia od 5s do 5min
maksymalny zasięg wykrywania ruchu wynoszący 8m
wykrywanie ruchu 0.3...3m/s (1...10km/h)
Materiał obudowy: żelazo
Materiał klosza: szkło

Kanlux FOGLER DL ceiling light fixture with a replaceable light source is a great choice for staircases, basements, attics and similar spaces. The built-in detector with the maximum angle (360°) of motion detection guarantees that the light turns on exactly when we need it.

provided with a motion sensor
maximum horizontal adjustment range for the motion sensor: 360°
maximum vertical motion sensor angle: 120°
lighting time adjustable in the range of 5 s to 5 min
maximum motion detection range: 8 m
motion detection 0.3...3 m/s (1...10 km/h)
Enclosure material: iron
Lampshade material: glass

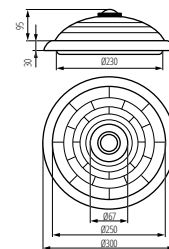

FOGLER DL-2400

Kanlux

JURBA DL

PLAFONIERA Z WYMIENNYM ŹRÓDŁEM ŚWIATŁA ► CEILING-MOUNTED LIGHT FITTING WITH REPLACEABLE LIGHT SOURCE



JURBA DL-2180



JURBA DL-2180 | 08980 | 5905339089809 | 2 x max 18 | CFL/LED | E27 | nikiel satynowy | nickel satin
JURBA DL-218L | 08981 | 5905339089816 | 2 x max 18 | CFL/LED | E27 | nikiel satynowy | nickel satin

[V] 220-240 AC	[Hz] 50/60	⏚	IP 44	🏠	🌡️ -10+35	📐	📦	📏 1-2,5	📏 0,1m
						CE	ERC		



JURBA DL-218L



Plafoniera hermetyczna Kanlux JURBA to doskonała jakość wykonania. Oprawę można montować zarówno na ścianie jak i na suficie, wewnątrz i na zewnątrz budynków. Oprawy Kanlux JURBA posiadają podwyższony stopień pyłoszczelności jak i wodoszczelności - IP44.

Materiał obudowy: stal
Materiał klosza: PC

Kanlux JURBA is a hermetic ceiling light fixture of excellent workmanship. The fixture can be mounted both on ceilings and on walls, indoors and outdoors. Kanlux JURBA luminaires have increased resistance to dust and water - IP44.

Enclosure material: steel
Lampshade material: PC

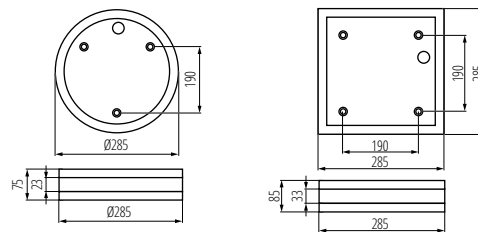

JURBA DL-2180

JURBA DL-218L

Kanlux

PIRES DL

PLAFONIERA Z WYMIENNYM ŹRÓDŁEM ŚWIATŁA ► CEILING-MOUNTED LIGHT FITTING WITH REPLACEABLE LIGHT SOURCE



PIRES DL-600



PIRES DL-600 NS



PIRES ECO DL-250



PIRES ECO DL-250 NS



Kanlux PIRES to plafoniera o minimalistycznym wyglądzie, którą dzięki stopniowi szczelności IP44 zastosujemy również na zewnątrz. Dla większego komfortu proponujemy Wam również wersje wyposażone w mikrofalowy czujnik ruchu (kod 19000 i 8810), którego zasięg wynosi 9 metrów).

wyposażona w mikrofalowy czujnik ruchu
maksymalny horyzontalny kąt działania czujnika ruchu wynoszący 360°
maksymalny wertykalny kąt działania czujnika ruchu wynoszący 140°
możliwość regulacji czasu świecenia od 8s do 12min
maksymalny zasięg wykrywania ruchu wynoszący 9m
wykrywanie ruchu 0.3...3m/s (1...10km/h), regulacja czułości w zakresie 2...2000lx
wersja PIRES DL-60 NS - bez czujnika ruchu

Materiał obudowy: stal

Kanlux PIRES is a ceiling light fixture with minimalistic appearance which can be used outside too thanks to IP44 degree of tightness. To increase comfort, we also propose versions equipped with a microwave motion detector (code 19000 and 8810) the range of which comes to 9 metres).

provided with a MW motion sensor
maximum horizontal adjustment range for the motion sensor: 360°
maximum vertical motion sensor angle: 140°
lighting time adjustable in the range of 8 s to 12 min
maximum motion detection range: 9 m
motion detection 0.3...3 m/s (1...10 km/h), sensitivity adjustment range: 2...2,000 lx
Enclosure material: steel



PIRES DL-600	08810	5905339088109	max 60	GLS/CFL/LED	E27	biały white	mikrofalowy microwave
PIRES DL-600 NS	08811	5905339088116	max 60	GLS/CFL/LED	E27	biały white	
PIRES ECO DL-250	19000	5905339190000	max 25	CFL/LED	E27	biały white	mikrofalowy microwave
PIRES ECO DL-250 NS	19001	5905339190017	max 25	CFL/LED	E27	biały white	

[V] 220-240 AC	[Hz] 50/60	IP 44	⊕ [°C] 5+35
⊕ [mm] 1-2,5	⊕ [m] 0,5m	⊕ [mm] 1-2,5	⊕ [mm] 0,5m
ERC	Kanlux		
A+ A B C D E			

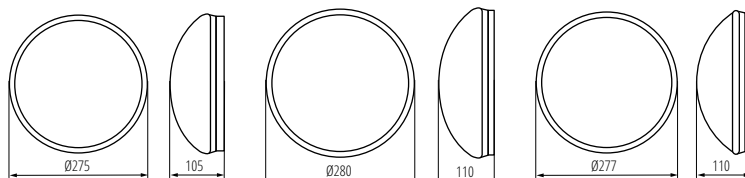

PIRES DL-600

PIRES DL-600 NS

PIRES ECO DL-250; PIRES ECO DL-250 NS

Kanlux

KIRA DL

PLAFONIERA Z WYMIENNYM ŹRÓDŁEM ŚWIATŁA ► CEILING-MOUNTED LIGHT FITTING WITH REPLACEABLE LIGHT SOURCE



KIRA DL-75B



KIRA DL-75B | 07900 | 5905339079008 max 75 GLS/CFL/LED E27 biały | white

[V] 220-240 AC	[Hz] 50/60	□	IP 44	🏠	🔧
IK 10	📏 0,5m	💡	CE	ERAC	

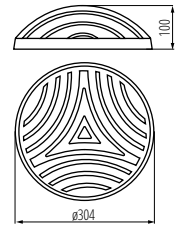

KIRA DL-75B

Kanlux

MARC DL

PLAFONIERA Z WYMIENNYM ŹRÓDŁEM ŚWIATŁA ► CEILING-MOUNTED LIGHT FITTING WITH REPLACEABLE LIGHT SOURCE



MARC DL-60



MARC DL-60 | 07015 | 5905339070159 max 60 GLS/CFL/LED E27 biały | white

[V] 220-240 AC	[Hz] 50/60	□	IP 54	🏠	🌡️ -10+35	🔧	IK 10
🔧	📏 1-1,5	📏 0,5m	💡	CE	ERAC		

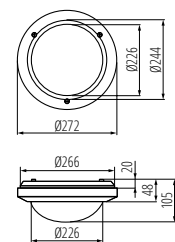

MARC DL-60



Plafoniera Kanlux KIRA posiada klosz wykonany z poliwęglanu, co czyni ją niezwykle odporną na uderzenia (IK10). Stopień IP44 informuje że można ją zamontować w pomieszczeniach, w których panuje wilgoć i zapylenie.

KIRA DL-29B wyposażone w urządzenie stabilizacyjno-zapłonowe (indukcyjne), klasa efektywności energetycznej B2

wysoka odporność na promieniowanie UV (PIKTO)

wysoka odporność na uderzenia

Materiał obudowy: tworzywo sztuczne

Materiał klosza: PC

Kanlux KIRA ceiling light fixture has a shade made of polycarbonate, which makes it extremely impact resistant (IK10). IP44 class informs that it can be mounted in rooms in which there is moisture and pollution.

KIRA DL-29B provided with a ballast-and-starter device (inductor), energy efficiency class: B2

high UV resistance (PICTO)

high impact resistance

Enclosure material: plastic

Lampshade material: PC



Plafoniera Kanlux MARC DL to prosty design, za którym kryje się jednak duża wytrzymałość oprawy na uderzenia (IK10). Wysoka odporność na zapylenie, wilgoć (IP54) i promieniowanie UV to dodatkowe atuty tej oprawy.

wysoka odporność na promieniowanie UV (PIKTO)

wysoka odporność na uderzenia

Materiał obudowy: PC

Materiał klosza: PC

Kanlux MARC DL ceiling light fixture combines simple design and high impact resistance of the luminaire (IK10). High resistance to dust, moisture (IP54) and UV radiation are other assets of the luminaire.

high UV resistance (PICTO)

high impact resistance

Enclosure material: PC

Lampshade material: PC

Kanlux INES

OPRAWA KANAŁOWA ► BULKHEAD FIXTURE



INES 7061N



INES 7061N | 70525 | 5905339705259 | max 100 | GLS/CFL/LED | E27 | biały | white

[V] 220-240 AC	[Hz] 50/60	□	IP 43	⌚	⚙️	⚙️
1	0,5m	⚡	CE	EAC	Kanlux A A A B C D E	

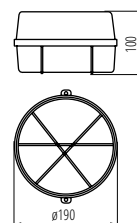

INES 7061N



Kanlux INES to wytrzymała oprawa hermetyczna (IK08), z wymiennym źródłem światła, która posiada dodatkową ochronę w postaci metalowej siatki.

Materiał obudowy: tworzywo sztuczne

Materiał klosza: szkło

Kanlux INES is a durable hermetic luminaire (IK08) with a replaceable light source and additional protection - a metal mesh.

Enclosure material: plastic

Lampshade material: glass

Kanlux MILO

OPRAWA KANAŁOWA ► BULKHEAD FIXTURE



MILO 7040T



MILO 7040T | 70522 | 5905339705228 | max 60 | GLS/CFL/LED | E27 | szary | grey
MILO 7040T/P | 70523 | 5905339705235 | max 60 | GLS/CFL/LED | E27 | szary | grey

[V] 220-240 AC	[Hz] 50/60	□	IP 54	⌚	⚙️	IK 06
1-1,5	0,5m	⚡	CE	EAC	Kanlux A A A B C D E	



MILO 7040T/P



Kanlux MILO to klasyczna oprawa kanałowa, którą zwykle stosuje się w pomieszczeniach technicznych, garażach, piwnicach, klatkach schodowych, korytarzach itp. Oprawa ta posiada metalową (7040T) lub plastikową (7040T/P) siatkę ochronną, która dodatkowo chroni klosz oprawy przed uszkodzeniami mechanicznymi.

Materiał obudowy: tworzywo sztuczne

Materiał klosza: szkło

Kanlux MILO is a classic channel luminaire used usually in technical rooms, garages, basements, staircases, corridors, etc. The luminaire has a metal (7040T) or plastic (7040T/P) protective mesh which protects the shade from mechanical damage.

Enclosure material: plastic

Lampshade material: glass

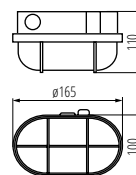

MILO 7040T

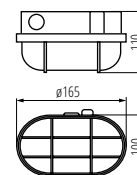

MILO 7040T/P

Kanlux

SANGA DL

PLAFONIERA Z WYMIENIANYM ŹRÓDŁEM ŚWIATŁA ► CEILING-MOUNTED LIGHT FITTING WITH REPLACEABLE LIGHT SOURCE



SANGA DL-100



SANGA DL-100 | 08050 | 5905339080509 max 100 GLS/CFL/LED E27 biały | white

[V] 220-240 AC	[Hz] 50/60		IP 44				
 1-1,5	 0,5m		CE	ERAC	 		

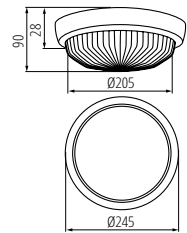

SANGA DL-100

Kanlux

HERMI

OPRAWA KANAŁOWA ► BULKHEAD FIXTURE



HERMI 7063NB



HERMI 7063NB | 70524 | 5905339705242 max 100 GLS/CFL/LED E27 biały | white

[V] 220-240 AC	[Hz] 50/60		IP 54		 -20+25			
 1-1,5			CE	ERAC	 			

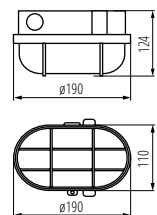

HERMI 7063NB



Plafoniera Kanlux SANGA to ekonomiczne rozwiązanie dla klatek schodowych, piwnic, strychów, garaży, lecz także dla tarasów i balkonów.

Materiał obudowy: tworzywo sztuczne

Materiał klosza: szkło

Kanlux SANGA ceiling fixture is an economical solution for staircases, basements, attics, garages, and also for terraces and balconies.

Enclosure material: plastic

Lampshade material: glass



Kanlux HERMI to oprawa kanałowa z wysokim stopniem szczelności (IP54), który świadczy o jej ochronie przed zapyleniem i bryzgami wody. Oprawa ta posiada dodatkowo metalową siatkę, która chroni klosz oprawy przed uszkodzeniami mechanicznymi.

Materiał obudowy: tworzywo sztuczne

Materiał klosza: szkło

Kanlux HERMI is a channel luminaire with a high tightness rating (IP54), which means high protection against dust and water splashes. The luminaire also has a metal mesh which protects the shade from mechanical damage.

Enclosure material: plastic

Lampshade material: glass

Kanlux TUNA

PLAFONIERA Z WYMIENNYM ŹRÓDŁEM ŚWIATŁA ► CEILING-MOUNTED LIGHT FITTING
WITH REPLACEABLE LIGHT SOURCE



TUNA S1101-W



TUNA MINI N



TUNA S1101-W	04260	5905339042606	max 100	GLS/CFL/LED	E27	biały white
TUNA MINI N	08091	5905339080912	max 100	GLS/CFL/LED	E27	biały white

[V] 220-240 AC	[Hz] 50/60	□ IP 44	🏠 E27	🔩 E27	📏 1-1,5	📏 0,5m	🔦 CE	🔦 EAC	
-------------------	---------------	---------------	----------	----------	------------	-----------	---------	----------	--



Plafoniera Kanlux TUNA to rozwiązanie dla klatek schodowych, piwnic, strychów i innych tego typu pomieszczeń. Odpowiedni stopień ochrony przed zapyleniem i wilgocią umożliwia stosowanie oprawy zarówno wewnątrz jak i na zewnątrz budynków.

Materiał obudowy: tworzywo sztuczne
Materiał klosza: szkło

Kanlux TUNA ceiling light fixture is a good choice for staircases, basements, attics and other such rooms. Proper level of protection against dust and moisture allows for its use both indoors and outdoors.

Enclosure material: plastic
Lampshade material: glass

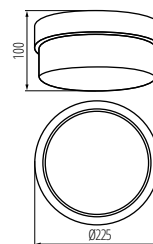

TUNA S1101

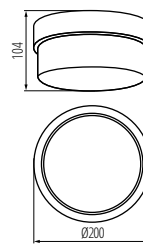

TUNA MINI

Kanlux TURK

PLAFONIERA Z WYMIENNYM ŹRÓDŁEM ŚWIATŁA ► CEILING-MOUNTED LIGHT FITTING
WITH REPLACEABLE LIGHT SOURCE



TURK DL-60



TURK DL-60	07025	5905339070258	max 60	E27	biały white
------------	--------------	---------------	--------	-----	---------------

[V] 220-240 AC	[Hz] 50/60	□ IP 54	🏠 E27	🔩 E27	📏 1-2,5	📏 0,5m	🔦 CE	🔦 EAC	
-------------------	---------------	---------------	----------	----------	------------	-----------	---------	----------	--



Kanlux TURK to bardzo wytrzymała na uderzenia plafoniera (IK10). Dodatkowa wysoka odporność na promieniowanie UV sprawia, że doskonale sprawdzi się w warunkach użytkowania zewnętrznego, np. na elewacji budynku, tarasie czy balkonie.

wysoka odporność na promieniowanie UV (PIKTO)
wysoka odporność na uderzenia

Kanlux TURK is an extremely impact resistant ceiling light fixture (IK10). Additional high resistance to UV radiation makes it perfect for outdoor use, e.g. on building façade, terrace or balcony.

high UV resistance (PICTO)
high impact resistance

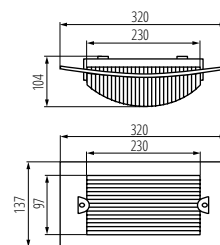

TURK DL-60

Kanlux

SHARK N

PLAFONIERA Z WYMIENNYM ŹRÓDŁEM ŚWIATŁA ► CEILING-MOUNTED LIGHT FITTING
WITH REPLACEABLE LIGHT SOURCE



SHARK N EL-60



SHARK N EL-60 | 29060 | 5905339290601 | max 40 | E27 | GLS/CFL/LED | szary | grey

[V] 220-240 AC	[Hz] 50/60	⏏	IP 44	🏠	🔩	🔧
📏 1-1,5	📏 0,5m	💡	CE	EAC		

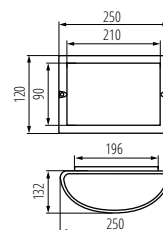

SHARK N EL-60



Kanlux SHARK to tradycyjna oprawa hermetyczna dla użytkowników, którzy cenią sobie wymienne źródło światła w tego typu oświetleniu. Charakteryzuje się wysoką odpornością na promieniowanie UV i uderzenia.

Materiał obudowy: stop aluminium

Materiał klosza: PC

Kanlux SHARK is a traditional hermetic fixture for those who appreciate a replaceable light source in this type of light fixture. It is characterised by its high resistance to UV radiation and impact.

Enclosure material: aluminum alloy

Lampshade material: PC





MATEO ES

OPRAWA TYPU DOWNLIGHT ► DOWNLIGHT FITTING



MATEO ES DLP-150-B



MATEO ES DLP-150-W



MATEO ES DLP-250-B



MATEO ES DLP-250-W



MATEO ES DLP-150-B	32930	5905339329301	max 25	czarny black
MATEO ES DLP-150-W	32931	5905339329318	max 25	biały white
MATEO ES DLP-250-B	32932	5905339329325	2 x max 25	czarny black
MATEO ES DLP-250-W	32933	5905339329332	2 x max 25	biały white

[V] 220-240 AC	[Hz] 50	ES-111	GU10	IP 20	0,5m	CE
5+25	65/35	1,5	0,5m			
ERC						

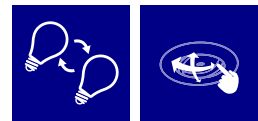

Kanlux MATEO ES to elegancka oprawa sufitowa, do której pasują efektowne żarówki Kanlux ES-111. Korpus oprawy jest wykonany ze stali i wykończony czarnym, matowym kolorem. Możemy wybrać między czarnym lub białym kolorem wykończenia lampy. Dzięki regulacji kątowej możemy skierować światło na wybrany przez nas punkt.

Materiał obudowy: stop aluminium

Kanlux MATEO ES is an elegant ceiling luminaire which can be matched with the spectacular Kanlux ES-111 bulbs. The luminaire body is made of steel and finished in matt black. You can choose between black or white lamp finish. Thanks to angle adjustment, you can direct the light to a selected point.

Enclosure material: aluminum alloy

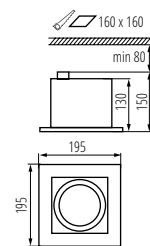

MATEO ES DLP-150

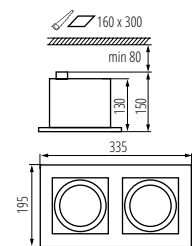

MATEO ES DLP-250

Kanlux MATEO

OPRAWA TYPU DOWNLIGHT ► DOWNLIGHT FITTING



MATEO DLP-150-GR



MATEO DLP-250-GR



MATEO DLP-350-GR

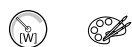

MATEO DLP-150-GR	04960	5905339049605	max 50	szary grey
MATEO DLP-250-GR	04961	5905339049612	2 x max 50	szary grey
MATEO DLP-350-GR	04962	5905339049629	3 x max 50	szary grey

			IP		
12 AC; 12 DC	G53		20		5+25
60/45			1-2,5		1m
	CE	ERC	Kanlux		

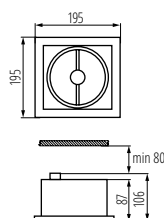

MATEO DLP-150

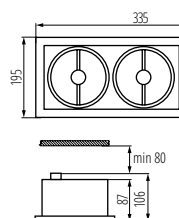

MATEO DLP-250

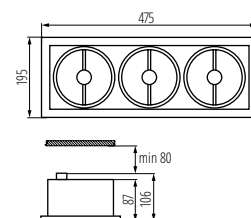

MATEO DLP-350

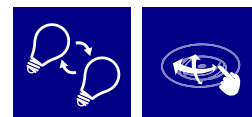

Kanlux MATEO to elegancka oprawa sufitowa posiadająca efektywny odbłyśnik. Połączenie srebrnego i czarnego koloru dodaje oprawom elegancji i wyrazistego oblicza. Dzięki regulacji kątowej możemy skierować światło na wybrany przez nas punkt.



Materiał obudowy: stal

Kanlux MATEO is an elegant ceiling luminaire with a spectacular reflector. The combination of silver and black colour makes the luminaires smart and distinct. Owing to angular adjustment, we can direct the light towards the selected point.



Enclosure material: steel

Kanlux ARTO

OPRAWA TYPU DOWNLIGHT ► DOWNLIGHT FITTING

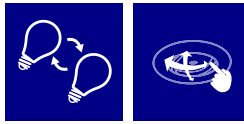

Oprawy Kanlux ARTO przeznaczone są dla źródeł światła typu AR111. To oprawa dyskretna o prostej stylistyce, z możliwością regulacji kąta padania światła.

Materiał obudowy: stal

Kanlux ARTO luminaires are designed for AR111 light sources. The luminaire is discrete, has a simple design and allows for adjusting the angle of light incidence.

Enclosure material: steel



ARTO 3L-SR



ARTO 3L-SR | 26616 | 5905339266163 | 3 x max 35 | srebrny | silver

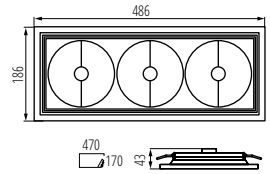

ARTO 3L



Kanlux RALF

OPRAWA TYPU DOWNLIGHT ► DOWNLIGHT FITTING



Oprawa typu downlight Kanlux RALF przeznaczona jest do wbudowania w sufit podwieszany. Z powodzeniem może być zastosowana w pomieszczeniach zarówno mieszkalnych jak i użyteczności publicznej.

Materiał obudowy: stal

Materiał klosza: szkło

Materiał odbłyśnika: stop aluminium

Kanlux RALF downlight luminaire is designed for mounting in suspended ceilings. It is perfect for both residential and public spaces.

Enclosure material: steel

Lampshade material: glass

Reflector material: aluminum alloy



RALF DL-220-W



RALF DL-220-W | 04820 | 5905339048202 | 2 x max 20 | biały | white

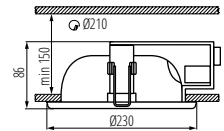
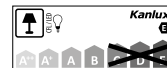

Kanlux TIBERI LED

OPRAWA TYPU DOWNLIGHT ► DOWNLIGHT FITTING



Okrągłe oprawy Kanlux TIBERI LED wykorzystują diody LED SMD do emitowania intensywnego światła, dzięki temu świetnie sprawdzą się w wyższych pomieszczeniach biurowych czy przemysłowych. Podwyższona szczelność IP44, chroni je przed kurzem, pyłem i wilgocią.

Materiał obudowy: stop aluminium

Materiał klosza: PS

Round Kanlux TIBERI LED luminaires use SMD LEDs to emit intense light. Owing to this, they work well in high office or industrial rooms. Increased tightness of IP44 protects them from dust, dirt and moisture.

Enclosure material: aluminum alloy

Lampshade material: PS



TIBERI LED SMD 24W-0



TIBERI LED SMD 24W-0 | 25510 | 5905339255105 | 24 | biały | white | 2400 | 100 | 4000
TIBERI LED SMD 36W-0 | 25511 | 5905339255112 | 36 | biały | white | 3900 | 100 | 4000

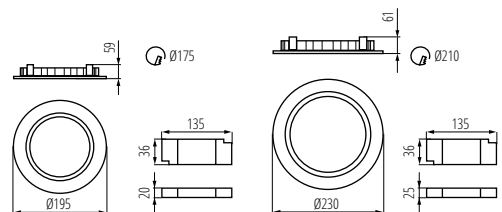

TIBERI LED SMD 24W

TIBERI LED SMD 36W

IVIAN LED

OPRAWA PUNKTOWA LED IP44 ▶ LED SPOTLIGHT FITTING, IP44



IVIAN LED 4,5W W-WW



IVIAN LED 4,5W SN-WW



Kanlux IVIAN LED to rodzina opraw typu downlight. Charakteryzuje się podwyższonym stopniem szczelności – IP44, co pozwala na zastosowanie jej w łazienkach i pomieszczeniach o zwiększonej wilgotności. Źródło światła stanowią diody LED SMD, a obudowa wykonana jest z tworzywa sztucznego.

Materiał obudowy: tworzywo sztuczne
Materiał klosza: tworzywo sztuczne

Kanlux IVIAN LED is a family of downlight type holders. It is characterized by an increased degree of tightness - IP44, which allows using it in bathrooms and rooms with increased humidity. LED SMD diodes are the light source and the casing is made of plastic.

Enclosure material: plastic
Lampshade material: plastic



IVIAN LED 4,5W W-WW	25780	5905339257802	4,5	biały white	340	100	3000
IVIAN LED 4,5W SN-WW	25781	5905339257819	4,5	nikiel satynowy nickel satin	340	100	3000
IVIAN LED 4,5W W-NW	25782	5905339257826	4,5	biały white	370	100	4000
IVIAN LED 4,5W SN-NW	25783	5905339257833	4,5	nikiel satynowy nickel satin	370	100	4000

[V] 220-240 AC	[Hz] 50/60	[h] ≥25000	[h] 15000	[lm] ≤ 6x MacAdam	Ra ≥80	SMD	IP 44
[°C] 5+25	[mm] Ø65	[m] 0,5m	[K] Tc [K]	[K] K	[K] K	[K] K	[K] K

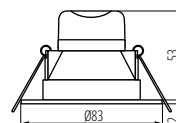

IVIAN LED 4,5W

LITEN LED

OPRAWA TYPU DOWNLIGHT ▶ DOWNLIGHT FITTING



LITEN LED 6W-NW



Oprawy downlight Kanlux LITEN LED ze zintegrowanym źródłem światła LED, przeznaczone są do zamontowania w suficie podwieszanym. Wszystkie oprawy sufitowe Kanlux LITEN LED posiadają wbudowany zasilacz umożliwiający podłączenie opraw do instalacji 230V AC.

Materiał obudowy: tworzywo sztuczne
Materiał klosza: tworzywo sztuczne

Kanlux LITEN LED downlights with integrated LED light source are designed for mounting in suspended ceilings. All Kanlux LITEN LED ceiling luminaires have a built-in power supply enabling connection of the luminaires to a 230V AC grid.

Enclosure material: plastic
Lampshade material: plastic

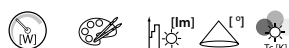

LITEN LED 6W-WW	25560	5905339255600	6	biały white	390	110	3000
LITEN LED 6W-NW	25561	5905339255617	6	biały white	390	110	4000
LITEN LED 8W-WW	25562	5905339255624	8	biały white	550	110	3000
LITEN LED 8W-NW	25563	5905339255631	8	biały white	550	110	4000

[V] 220-240 AC	[Hz] 50/60	[h] ≥25000	[h] 20000	[lm] ≤ 6x MacAdam	Ra ≥80	SMD	IP 40/20
[°C] 5+25	[mm] Ø109	[m] 0,5m	[K] Tc [K]	[K] K	[K] K	[K] K	[K] K

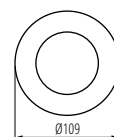
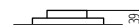

LITEN LED 6W

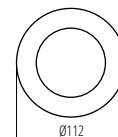
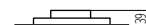

LITEN LED 8W

AREL LED

OPRAWA TYPU DOWNLIGHT ► DOWNLIGHT FITTING



AREL LED DO 25W

IP
65/20

ultra
SLIM
panel

HIGH
quality

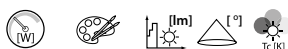

AREL LED DO 6W-NW	29580	5905339295804	6	biały white	450	120	4000
AREL LED DO 6W-WW	29581	5905339295811	6	biały white	440	120	3000
AREL LED DL 6W-NW	29582	5905339295828	6	biały white	490	120	4000
AREL LED DL 6W-WW	29583	5905339295835	6	biały white	450	120	3000
AREL LED DO 10W-NW	29584	5905339295842	10	biały white	940	120	4000
AREL LED DO 10W-WW	29585	5905339295859	10	biały white	890	120	3000
AREL LED DL 10W-NW	29586	5905339295866	10	biały white	1000	120	4000
AREL LED DL 10W-WW	29587	5905339295873	10	biały white	910	120	3000
AREL LED DO 14W-NW	29588	5905339295880	14	biały white	1300	120	4000
AREL LED DO 14W-WW	29589	5905339295897	14	biały white	1210	120	3000
AREL LED DL 14W-NW	29590	5905339295903	14	biały white	1300	120	4000
AREL LED DL 14W-WW	29591	5905339295910	14	biały white	1300	120	3000
AREL LED DO 20W-NW	29592	5905339295927	20	biały white	1710	120	4000
AREL LED DO 20W-WW	29593	5905339295934	20	biały white	1450	120	3000
AREL LED DL 20W-NW	29594	5905339295941	20	biały white	1710	120	4000
AREL LED DL 20W-WW	29595	5905339295958	20	biały white	1450	120	3000
AREL LED DO 25W-NW	29596	5905339295965	25	biały white	2200	120	4000
AREL LED DO 25W-WW	29597	5905339295972	25	biały white	2260	120	3000
AREL LED DL 25W-NW	29598	5905339295989	25	biały white	2200	120	4000
AREL LED DL 25W-WW	29599	5905339295996	25	biały white	2260	120	3000



Kanlux AREL LED to nowa rodzina downlightów, które nie posiadają ramki. Wysoka klasa szczelności IP65/20 oraz wyjątkowy, prosty, a zarazem zaskakujący design sprawia, że Kanlux AREL LED wpasuje się w każde wnętrze. Dzięki unikatowej konstrukcji, panel ma grubość zaledwie 9 mm – to najcieńszy panel dostępny na rynku

Materiał obudowy: stop aluminium

Materiał klosza: PMMA

Kanlux AREL LED is a new family of downlights which do not have frame. High tightness class IP65/20 and exceptional, simple, and at the same time surprising design make Kanlux AREL LED fit into each interior. Thanks to the unique structure, the panel is only 9 mm thick - it is the thinnest panel available on the market

Enclosure material: aluminum alloy

Lampshade material: PMMA

[V] 220-240 AC	[Hz] 50	[lm] ≥15000	[h] 30000	[lm] ≤6k MacAdam	Ra ≥80	SMD	IP 65/20
[°C] 5+25	[mm] 0,75-1,5	[mm] 0,5m	CE	ERAC			

AREL LED

OPRAWA TYPY DOWNLIGHT ► DOWNLIGHT FITTING



AREL LED DO 6W



AREL LED DL 6W



AREL LED DO 10W



AREL LED DL 10W



AREL LED DO 14W



AREL LED DL 14W



AREL LED DO 20W



AREL LED DL 20W



AREL LED DO 25W



AREL LED DL 25W

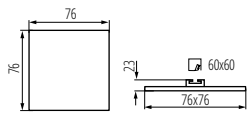

AREL LED DL 6W

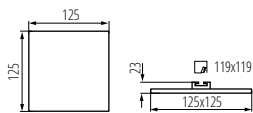

AREL LED DL 10W

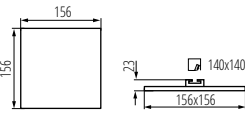

AREL LED DL 14W

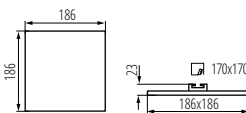

AREL LED DL 20W

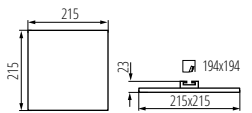

AREL LED DL 25W

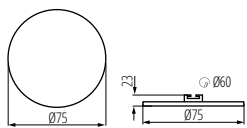

AREL LED DO 6W

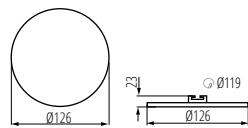

AREL LED DO 10W

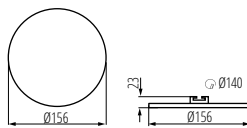

AREL LED DO 14W

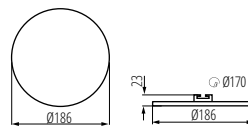

AREL LED DO 20W

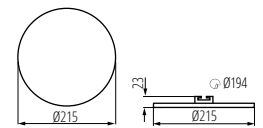

AREL LED DO 25W



ROUNDA V2LED

OPRAWA TYPU DOWNLIGHT ► DOWNLIGHT FITTING



ROUNDA V2LED6W-NW-W



ROUNDA V2LED12W-NW-SR



ROUNDA V2LED18W-NW-SN



ROUNDA V2LED24W-NW-W



Kanlux ROUNDA V2LED to nowa wersja popularnych okrągłych opraw typu downlight do użytku wewnętrznego. Downlighty te łączą w sobie estetyczne wzornictwo ze światłem uzyskiwanym dzięki technologii LED. Wysoka klasa szczelności IP44 zapobiega wnikaniu wody i kurzu do wnętrza.

Materiał obudowy: stop aluminium
Materiał klosza: tworzywo sztuczne

Kanlux ROUNDA V2LED is a new version of popular round downlight luminaires for indoor use. The downlights combine aesthetic design with light obtained thanks to LED technology. No water or dust can get to the inside owing to the high class of tightness (IP44).

Enclosure material: aluminum alloy
Lampshade material: plastic



ROUNDA V2LED6W-NW-SN	27221	5905339272218	6	nikiel satynowy nickel satin	300	110	4000
ROUNDA V2LED12W-NW-SR	28930	5905339289308	12	srebrny silver	660	110	4000
ROUNDA V2LED12W-NW-W	28931	5905339289315	12	biały white	780	110	4000
ROUNDA V2LED12W-WW-W	28932	5905339289322	12	biały white	720	110	3000
ROUNDA V2LED18W-NW-SR	28933	5905339289339	18	srebrny silver	1080	110	4000
ROUNDA V2LED18W-NW-W	28934	5905339289346	18	biały white	1260	110	4000
ROUNDA V2LED18W-WW-W	28935	5905339289353	18	biały white	1200	110	3000
ROUNDA V2LED24W-NW-W	28936	5905339289360	24	biały white	1680	110	4000
ROUNDA V2LED6W-NW-W	28937	5905339289377	6	biały white	330	110	4000
ROUNDA V2LED6W-WW-W	28938	5905339289384	6	biały white	300	110	3000

[V] 220-240 AC	[Hz] 50/60	[lm] ≥20000	[h] 15000	[lm] ≤60 MacAdam	Ra ≥80	SMD	IP 44/20
[°C] 5-25	[mm] 0,05	[mm] 0,75	[m] 0,5m	CE	ERC	Kanlux	

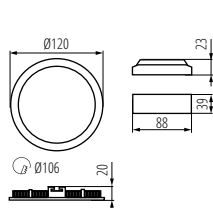

ROUNDA V2LED6W

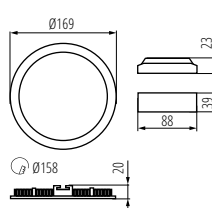

ROUNDA V2LED12W

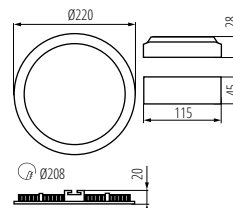

ROUNDA V2LED18W

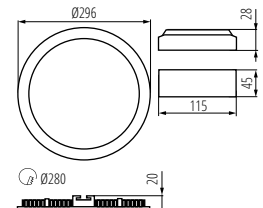

ROUNDA V2LED24W

KATRO V2LED

OPRAWA TYPU DOWNLIGHT ► DOWNLIGHT FITTING



KATRO V2LED 18W-NW-W



KATRO V2LED 6W-NW-W



KATRO V2LED 12W-NW-SR



KATRO V2LED 24W-NW-SN



Kanlux KATRO V2LED to nowa wersja opraw KATRO N LED, popularnych kwadratowych downlightów do użytku wewnętrznego. Łączy w sobie estetyczne wzornictwo ze światłem uzyskiwanym dzięki technologii LED. Wysoka klasa szczelności IP44 zapobiega wnikaniu wody i kurzu do wnętrza.

Materiał obudowy: stop aluminium
Materiał klosza: tworzywo sztuczne

Kanlux KATRO V2LED is a new version of KATRO N LED luminaires, popular square downlights for indoor use. They combine aesthetic design with light obtained owing to LED technology. No water or dust can get to the inside owing to the high class of tightness (IP44).

Enclosure material: aluminum alloy
Lampshade material: plastic



Model	Code	Power (W)	Color	Beam Angle (°)	Temp (K)	Life (h)
KATRO V2LED 24W-NW-SN	27216	24	nikiel satynowy nickel satin	1700	110	4000
KATRO V2LED 6W-NW-SN	27217	6	nikiel satynowy nickel satin	300	110	4000
KATRO V2LED 12W-NW-SR	28939	12	srebrny silver	660	110	4000
KATRO V2LED 12W-NW-W	28940	12	biały white	780	110	4000
KATRO V2LED 12W-WW-W	28941	12	biały white	720	110	3000
KATRO V2LED 18W-NW-SR	28942	18	srebrny silver	1080	110	4000
KATRO V2LED 18W-NW-W	28943	18	biały white	1260	110	4000
KATRO V2LED 18W-WW-W	28944	18	biały white	1200	110	3000
KATRO V2LED 24W-NW-W	28945	24	biały white	1680	110	4000
KATRO V2LED 6W-NW-W	28946	6	biały white	330	110	4000
KATRO V2LED 6W-WW-W	28947	6	biały white	300	110	3000

[V] 220-240 AC	[Hz] 50/60	≥20000	15000	elliptic ≤ 6x Max diam	Ra ≥80	SMD	IP 44/20
5+25			0,05	0,75	0,5m	CE	EAC

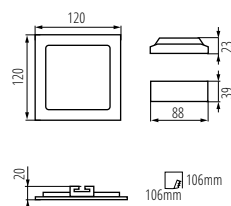

KATRO V2LED 6W

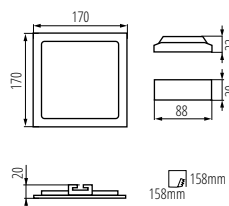

KATRO V2LED 12W

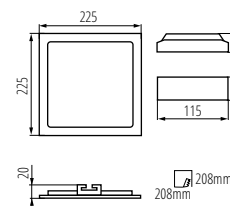

KATRO V2LED 18W

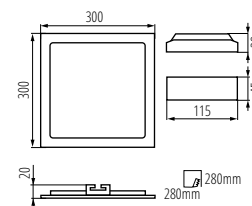

KATRO V2LED 24W

Kanlux NIKOR

OPRAWA TYPU DOWNLIGHT ► DOWNLIGHT FITTING



NIKOR DLP-60-W



NIKOR DLP-60-W | 07210 | 5905339072108 max 60 biały | white

[V] 220-240 AC	[Hz] 50/60	E27	IP 20	5+25
1+2,5	0,5m	CE	ERC	

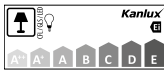

Kanlux NIKOR to oprawa typu downlight o nowoczesnym wzornictwie. Atrakcyjny wygląd, przemyślana konstrukcja i łatwy montaż to jej główne atuty. Do oprawy dopasujemy wybrane źródło światła z trzonkiem E27. Kanlux NIKOR dzięki nowoczesnemu wzornictwu idealnie pasują zarówno do wnętrz mieszkalnych jak i powierzchni komercyjnych.

Materiał obudowy: stal

Materiał odbłyśnika: stop aluminium

Kanlux NIKOR is a downlight luminaire of modern design. Attractive design, well-thought construction and easy assembly are its core assets. We can match the selected light source with an E27 screw. Owing to their modern design, Kanlux NIKOR perfectly match both residential interiors and commercial spaces.

Enclosure material: steel

Reflector material: aluminum alloy

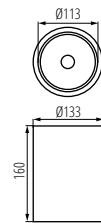

NIKOR DLP-60

Kanlux OMERIS LED

OPRAWA TYPU DOWNLIGHT ► DOWNLIGHT FITTING



OMERIS N LED 25W-NW-W



OMERIS N LED 25W-NW-W | 23362 | 5905339233622 25 biały | white 1950 85 4000

[V] 220-240 AC	[Hz] 50/60	≥15000	30000	≤60 MacAdam	Ra ≥80	SMD	IP 20
0,75+1,5	0,5m	CE	ERC				



Kanlux OMERIS to nowoczesna, zintegrowana oprawa typu downlight o prostym uniwersalnym kształcie. Oprawa wykonana jest z aluminium malowanego na kolor biały. Dzięki ponadczasowemu wzornictwu, oprawy Kanlux OMERIS idealnie pasują zarówno do wnętrz mieszkalnych jak i powierzchni komercyjnych.

łatwy montaż, nowoczesny design

Materiał obudowy: stop aluminium

Materiał klosza: tworzywo sztuczne

Kanlux OMERIS is a modern, integrated downlight luminaire of a simple, universal shape. It is made of aluminium painted in white. With their timeless design, Kanlux OMERIS luminaires are perfect for lighting residential interiors and office rooms.

easy installation, modern design

Enclosure material: aluminum alloy

Lampshade material: plastic

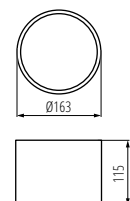

OMERIS N LED 25W

Kanlux

CARSA V2LED

OPRAWA TYPU DOWNLIGHT ► DOWNLIGHT FITTING



CARSA V2LED 12W-NW-SN



Kanlux CARSA V2 LED to okrągła oprawa natynkowa charakteryzująca się harmonijnym połączeniem technologii LED z atrakcyjnym i nowoczesnym wyglądem. Wyróżnia się wysoką energooszczędnością, przy jednoczesnym zachowaniu doskonałych parametrów świetlnych. Kanlux CARSA V2 LED doskonale sprawdza się w oświetleniu wnętrz mieszkalnych jak i pomieszczeń biurowych.

Materiał obudowy: stop aluminium

Materiał klosza: tworzywo sztuczne

Kanlux CARSA V2 LED is a round façade luminaire characterised by harmonious combination of LED technology with attractive and modern looks. It is distinguished by high energy efficiency with maintained excellent light parameters. Kanlux CARSA V2 LED is perfect for lighting residential interiors and office rooms.

Enclosure material: aluminum alloy

Lampshade material: plastic

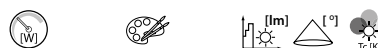

CARSA V2LED 12W-NW-SN	27210	5905339272102	12	nikiel satynowy nickel satin	720	110	4000
CARSA V2LED 18W-NW-SN	27211	5905339272119	18	nikiel satynowy nickel satin	1200	110	4000
CARSA V2LED 12W-NW-W	28948	5905339289483	12	biały white	780	110	4000
CARSA V2LED 18W-NW-W	28949	5905339289490	18	biały white	1260	110	4000

[V] 220-240 AC	[Hz] 50/60	≥20000	(h) 15000	ellipse ≤ 6x MacAdam	Ra ≥80	SMD	0,05	0,75	0,5m
IP 20	5+25	5+25	5+25	5+25	5+25	5+25	5+25	5+25	5+25
CE	ERAC								

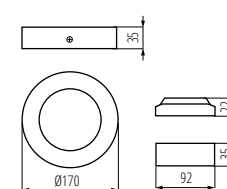

CARSA V2LED 12W

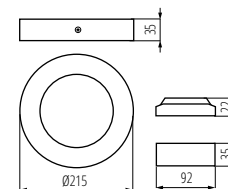

CARSA V2LED 18W

Kanlux

KANTI V2LED

OPRAWA TYPU DOWNLIGHT ► DOWNLIGHT FITTING



KANTI V2LED 18W-NW-SN



Kanlux KANTI V2 LED to kwadratowa oprawa natynkowa charakteryzująca się harmonijnym połączeniem nowoczesnej technologii z atrakcyjnym i nowoczesnym wyglądem. Wyróżnia się wysoką energooszczędnością, przy jednoczesnym zachowaniu doskonałych parametrów świetlnych. Kanlux KANTI V2 LED doskonale sprawdza się w oświetleniu wnętrz mieszkalnych i pomieszczeń biurowych.

Materiał obudowy: stop aluminium

Materiał klosza: tworzywo sztuczne

Kanlux KANTI V2 LED is a square façade luminaire characterised by harmonious combination of modern technology with attractive and modern looks. It is distinguished by high energy efficiency with maintained excellent light parameters. Kanlux KANTI V2 LED is perfect for lighting residential interiors and office rooms.

Enclosure material: aluminum alloy

Lampshade material: plastic



KANTI V2LED 12W-NW-SN	27212	5905339272126	12	nikiel satynowy nickel satin	720	110	4000
KANTI V2LED 18W-NW-SN	27213	5905339272133	18	nikiel satynowy nickel satin	1200	110	4000
KANTI V2LED 12W-NW-W	28950	5905339289506	12	biały white	780	110	4000
KANTI V2LED 18W-NW-W	28951	5905339289513	18	biały white	1260	110	4000

[V] 220-240 AC	[Hz] 50/60	≥20000	(h) 15000	ellipse ≤ 6x MacAdam	Ra ≥80	SMD	0,05	0,75	0,5m
IP 20	5+25	5+25	5+25	5+25	5+25	5+25	5+25	5+25	5+25
CE	ERAC								

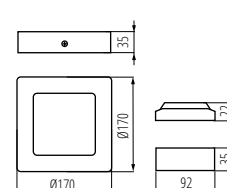

KANTI V2LED 12W

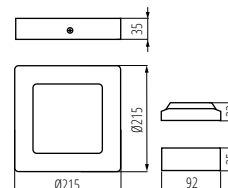

KANTI V2LED 18W

FL MASTER LED

NAŚWIETLACZ LED ► LED FLOODLIGHT



FL MASTER LED 100W



FL MASTER LED 100W



FL MASTER LED 140W



FL MASTER LED 220W



5
WARRANTY
5 years

BRANDED
components

IP
65

HIGH
efficacy

Kanlux FL MASTER to przede wszystkim niezawodność i odporność na warunki atmosferyczne. Jego dodatkowe atuty to wysoka szczelność, stabilna obudowa i zasilacz współpracujący ze ściemniaczem. Markowe komponenty naświetlacza to dodatkowa gwarancja jego skuteczności.

5 lat Gwarancji na warunkach oświadczenia gwarancyjnego, dostępnego na stronie internetowej

Materiał obudowy: stop aluminium

Materiał szyby ochronnej: szkło hartowane

The Kanlux FL MASTER is, above all, about reliability and resistance to weather conditions. Its additional advantages are the high tightness level, stable casing, and power supply, which works with the dimmer. The branded components of the floodlight mean an additional guarantee of its effectiveness.

5 years Warranty under the terms of the warranty statement, available on our website

Enclosure material: aluminum alloy

Protective glass material: Tempered glass

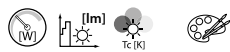

FL MASTER LED 100W-NW	28490	5905339284907	100	13000	4000	czarny black
FL MASTER LED 140W-NW	28491	5905339284914	140	18200	4000	czarny black
FL MASTER LED 220W-NW	28492	5905339284921	220	28600	4000	czarny black

[V] 220-240 AC	[Hz] 50/60	[°] 120	[lm] ≥15000	[h] 50000	[lm] ≤ 60 Maczków	Ra ≥80	SMD	1-10V	IP 65	°C -40÷40
IK 180	08	[m] 0,4	[m] 1	[m] 1m	CE	ERAC				

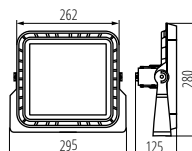

FL MASTER LED 100W

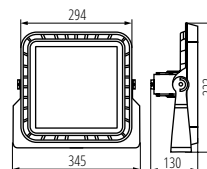

FL MASTER LED 140W

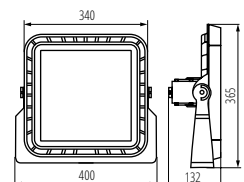

FL MASTER LED 220W

FLM LED

NAŚWIETLACZ LED ▶ LED FLOODLIGHT



FLM LED 100W



FLM LED 100W

FLM LED 140W

FLM LED 220W

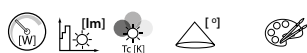

Model	Code	Power [W]	Beam Angle [°]	Beam Diameter [mm]	Beam Length [mm]	Beam Width [mm]	Color
FLM LED 100W-NW-60D	28520	5905339285201	100	12750	4000	60	czarny black
FLM LED 100W-NW110/150	28521	5905339285218	100	12100	4000	X110/Y150	czarny black
FLM LED 140W-NW-60D	28522	5905339285225	140	17850	4000	60	czarny black
FLM LED 140W-NW110/150	28523	5905339285232	140	16950	4000	X110/Y150	czarny black
FLM LED 220W-NW-60D	28524	5905339285249	220	28050	4000	60	czarny black
FLM LED 220W-NW110/150	28525	5905339285256	220	26600	4000	X110/Y150	czarny black

[V]	[Hz]	[lm]	[h]	ellipse ≤ 6x MacAdam	Ra	SMD	1-10V	IP	°C
220-240 AC	50/60	≥15000	50000	≥80	≥80	SMD	1-10V	65	-40÷40
[IK]	[mm]	[mm]	[m]	[m]	[m]	[m]	[m]	[m]	[m]
180	08	0,4	1	1m	1m	1m	1m	1m	1m

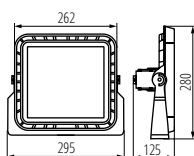

FLM LED 100W

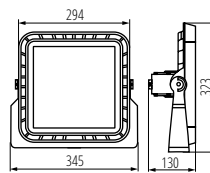

FLM LED 140W

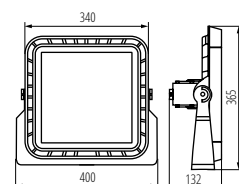

FLM LED 220W

WARRANTY
5 years

BRANDED
components

IP
65

HIGH
efficacy

Naświetlacz Kanlux FLM MASTER to specjalna wersja naświetlacza FL MASTER, który wyposażony jest w dodatkowe typy soczewek: wąskostrumieniową - która zmienia kąt świecenia na 60° lub asymetryczną, przy której kąt świecenia wynosi odpowiednio: X=110°, Y=150.

Produkty na indywidualne zamówienie po konsultacji z działem handlowym.

5 lat Gwarancji na warunkach oświadczenia gwarancyjnego, dostępnego na stronie internetowej

Materiał obudowy: stop aluminium

Materiał szyby ochronnej: szkło hartowane

Kanlux FLM MASTER floodlight is a special version of the FL MASTER floodlight, which is equipped with additional types of lenses - narrow-beam - which changes the angle of illumination to 60° - or asymmetrical - for which the beam angle is respectively: X=110°, Y=150.

Products available on individual order after consultation with the sales department

5 years Warranty under the terms of the warranty statement, available on our website

Enclosure material: aluminum alloy

Protective glass material: Tempered glass

ANTEM LED

NAŚWIETLACZ LED ► LED FLOODLIGHT



ANTEM LED 10W-NW-SE B



ANTEM LED 20W-NW B



ANTEM LED 30W-NW B



ANTEM LED 50W-NW-SE B



Model	Code	Power [W]	Beam angle [°]	Color temperature [K]	IP	Material
ANTEM LED 10W-NW B	33200	10	800	4000	65	czarny black
ANTEM LED 20W-NW B	33201	20	1600	4000	65	czarny black
ANTEM LED 30W-NW B	33202	30	2400	4000	65	czarny black
ANTEM LED 50W-NW B	33203	50	4000	4000	65	czarny black
ANTEM LED 100W-NW B	33204	100	8000	4000	65	czarny black
ANTEM LED 10W-NW-SE B	33205	10	800	4000	44	czarny black PIR
ANTEM LED 20W-NW-SE B	33206	20	1600	4000	44	czarny black PIR
ANTEM LED 30W-NW-SE B	33207	30	2400	4000	44	czarny black PIR
ANTEM LED 50W-NW-SE B	33208	50	4000	4000	44	czarny black PIR

[V] 220-240 AC	[Hz] 50	[°] 100	[lm] ≥10000	[h] 15000	[K] 4000	ellipse ≤60°/nacisk
Ra ≥80	SMD				-20+35	
[°] 180		[mm] 1-1,5	1m			Kanlux

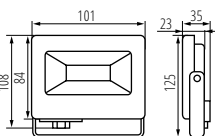

ANTEM LED 10W-NW B

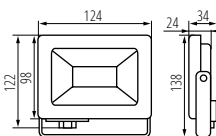

ANTEM LED 20W-NW B

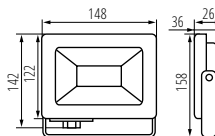

ANTEM LED 30W-NW B

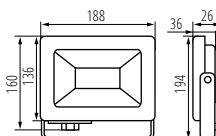

ANTEM LED 50W-NW B

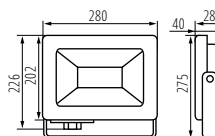

ANTEM LED 100W-NW B



Kanlux ANTEM to seria naświetlaczy LED. Te naświetlacze to przede wszystkim łatwość podłączenia, a dzięki zintegrowanej puszcze przyłączeniowej unikamy również nieestetycznego podłączenia kabla. Kanlux ANTEM LED to szeroki wybór mocy od: 10 W do 100 W, a także wersje z czujnikami ruchu i bez. Mleczny klosz z delikatną pryzmą miękko rozprasza światło i ogranicza efekt oślenia. Wersja bez czujnika ruchu odznacza się szczelnością IP65, a wersja z czujnikiem IP44. Czujnik nastawić można w zakresie czasu świecenia, natężenia światła i obszaru detekcji.

Materiał obudowy: stop aluminium
Materiał szyby ochronnej: szkło hartowane
Materiał wysięgnika: metal

Kanlux ANTEM is a series of LED floodlights. These floodlights are above all easy to connect, and thanks to the integrated junction box you can also avoid unaesthetic cable connections. Kanlux ANTEM LED series provides a wide range of power options, from 10 W to 100 W, as well as versions with and without motion sensors. A milky lampshade with a delicate prism softly disperses light and reduces the glare effect. The version without a motion sensor has a tightness of IP65, while the one with a sensor has a tightness of IP44. The sensor can be adjusted in terms of light duration, light intensity and detection range.

Enclosure material: aluminum alloy
Protective glass material: Tempered glass
Extension-arm material: Metal

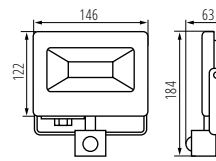

ANTEM LED 30W-NW-SE B

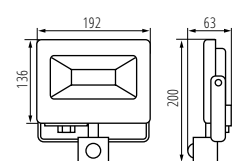

ANTEM LED 50W-NW-SE B

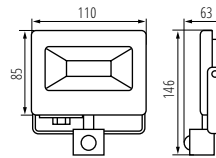

ANTEM LED 10W-NW-SE B

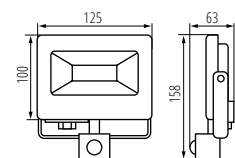

ANTEM LED 20W-NW-SE B

ANTOS LED

NAŚWIETLACZ LED ► LED FLOODLIGHT



ANTOS LED 10W-NW-SE B



ANTOS LED 20W-NW B



ANTOS LED 30W-NW B



ANTOS LED 50W-NW-SE B



Kanlux ANTOS LED to stylowe, ultrakompaktowe naświetlacze LED. Ważną cechą tych opraw jest wyprofilowany wysięgnik, dzięki któremu możemy zamocować je bez konieczności demontażu uchwytu.



Wersja naświetlacza ANTOS + SE - z czujnikiem ruchu
Materiał obudowy: stop aluminium
Materiał szyby ochronnej: szkło hartowane
Materiał odbłyśnika: stop aluminium



Kanlux ANTOS LED are stylish, ultra-compact LED floodlights. What is important, the luminaires have a profiled arm allowing for mounting with no need to disassemble the handle.

Version of the floodlight ANTOS + SE - with a motion sensor
Enclosure material: aluminum alloy
Protective glass material: Tempered glass
Reflector material: aluminum alloy



Model	Code	Power [W]	Beam Angle [°]	Light Output [lm]	Beam Diameter [mm]	Height [mm]	Color	Features
ANTOS LED 10W-NW B	27090	10	800	4000	65	czarny black		
ANTOS LED 20W-NW B	27091	20	1600	4000	65	czarny black		
ANTOS LED 30W-NW B	27092	30	2400	4000	65	czarny black		
ANTOS LED 50W-NW B	27093	50	4000	4000	65	czarny black		
ANTOS LED 10W-NW-SE B	27094	10	800	4000	44	czarny black	PIR	
ANTOS LED 20W-NW-SE B	27095	20	1600	4000	44	czarny black	PIR	
ANTOS LED 30W-NW-SE B	27096	30	2400	4000	44	czarny black	PIR	
ANTOS LED 50W-NW-SE B	27097	50	4000	4000	44	czarny black	PIR	

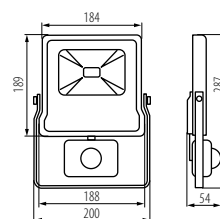

ANTOS LED 50W-SE

[V]	[Hz]	[°]	[h]	[lm]	[Ra]	[SMD]	[m]	[mm]	[m]
220-240 AC	50/60	120	≥15000	25000	≥80	SMD	0,25	1	0,5m
[°C]	[°C]	[°]	[h]	[m]	[mm]	[m]			
-20+35	180								

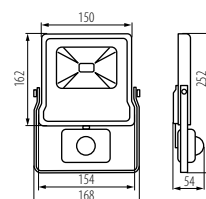

ANTOS LED 30W-SE

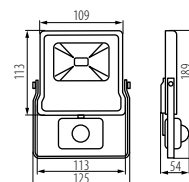

ANTOS LED 20W-SE

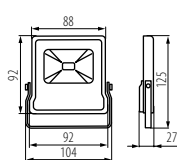

ANTOS LED 10W

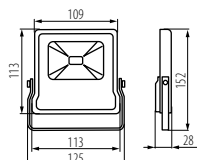

ANTOS LED 20W

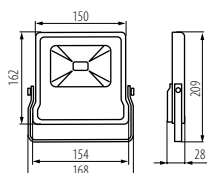

ANTOS LED 30W

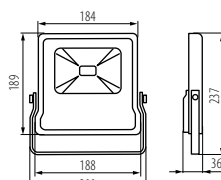

ANTOS LED 50W

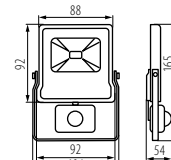

ANTOS LED 10W-SE

STATO LED

NAŚWIETLACZ LED ► LED FLOODLIGHT



STATO LED 30W-B



STATO LED 30W-B



STATO LED 50W-B

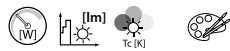

STATO LED 30W-B	29220	5905339292209	30	2700	4000	czarny black
STATO LED 50W-B	29221	5905339292216	50	4500	4000	czarny black

[V]	[Hz]	[°]	[lm]	[h]	[lm]	Ra	SMD	IP
220-240 AC	50/60	120	≥15000	25000	≤ 60 Max/Min	≥80	SMD	65
[°C]	[mm]	[mm]	[mm]	[m]	[m]	CE	EAC	
-20+35	2	1	1m	1m				

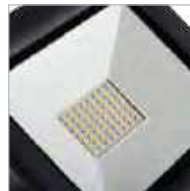

Kanlux STATO LED to przenośny naświetlacz o wysokiej szczelności (IP65). Polecany jako oświetlenie przy remontach czy pracach budowlanych. Regulacja kąta nachylenia naświetlacza i statywu pozwala na doświetlanie powierzchni w wielu płaszczyznach, wyższy współczynnik oddawania barw niż większość naświetlaczy (CRI≥80) to możliwość używania wewnątrz pomieszczeń (przy remontach lepiej widać barwy oświetlanej powierzchni). W Kanlux STATO LED w komplecie znajduje się 2 metrowy kabel z wtyczką.

Materiał obudowy: stop aluminium
Materiał szyby ochronnej: szkło hartowane
Materiał wysięgnika: stal

Kanlux STATO LED is a portable floodlight with high tightness (IP65). Recommended as lighting during renovations or building works. Adjustment of the inclination angle of the floodlight and the stand allows to additionally light up surface in a lot of planes, higher colour rendering index than most floodlights (CRI≥80) is a possibility of using inside rooms (during renovations, colours of lighted surface are better visible). In Kanlux STATO LED the set contains a 2-metre cable with a plug.

Enclosure material: aluminum alloy
Protective glass material: Tempered glass
Extension-arm material: steel

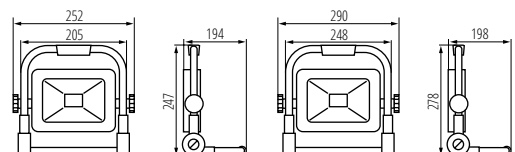

STATO LED 30W-B

STATO LED 50W-B

Kanlux

ADAMO MTH

NAŚWIETLACZ Z WYMIENNYM ŹRÓDŁEM ŚWIATŁA ► FLOODLIGHT WITH REPLACEABLE LIGHT SOURCE



ADAMO MTH-400/S



ADAMO MTH-400/A



ADAMO MTH-400/S	04842	5905339048424	400	MTH	E40	czarny black
ADAMO MTH-400/A	04846	5905339048462	400	MTH	E40	czarny black

[V] 220-240 AC	[Hz] 50/60	METALHALIDE	IP 65		 -20+35		 180
 1-2,5	 BALLAST	 2m					

AKCESORIA ► ACCESSORIES

GL-ADAMO 250/400	72372	5905339723727	szybka ochronna do oprawy ADAMO MTH, GL-ADAMO 250/400, (72372) protective glass for ADAMO MTH light fixtures, GL-ADAMO 250/400, (72372)			
------------------	--------------	---------------	---	--	--	--

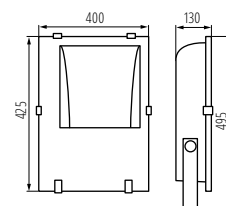

ADAMO MTH-400

Kanlux

AVIA MTH

NAŚWIETLACZ Z WYMIENNYM ŹRÓDŁEM ŚWIATŁA ► FLOODLIGHT WITH REPLACEABLE LIGHT SOURCE



AVIA MTH-478/400W-B



AVIA MTH-478/400W-B	04011	5905339040114	400	MTH	E40	czarny black
---------------------	--------------	---------------	-----	-----	-----	----------------

[V] 220-240 AC	[Hz] 50/60	METALHALIDE	IP 65		 -20+35		 180
 1-2,5	 BALLAST	 2m					

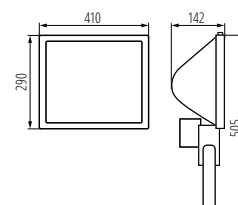

AVIA MTH-400W



Kanlux ADAMO MTH to naświetlacz metalohalogenkowy z wymiennym źródłem światła. Posiada wysoki stopień szczelności IP65, świetnie więc sprawdzi się w oświetleniu dużych obiektów, tj. boisk, hal, parkingów, placów itp.

Materiał obudowy: stop aluminium
Materiał szyby ochronnej: szkło hartowane
Materiał odbłyśnika: stop aluminium

Kanlux ADAMO MTH is a metal-halide floodlight with a replaceable light source. Owing to the high rating of tightness IP65, it is a good choice for lighting large venues, e.g. pitches, halls, parking lots, squares, etc.

Enclosure material: aluminum alloy
Protective glass material: Tempered glass
Reflector material: aluminum alloy



Kanlux AVIA MTH to naświetlacz z wymiennym źródłem światła o trzonku E40. Posiada wysoki stopień szczelności IP65, świetnie więc sprawdzi się w oświetleniu dużych obiektów, tj. boisk, hal, parkingów, placów itp.

Materiał obudowy: stop aluminium
Materiał szyby ochronnej: szkło hartowane
Materiał odbłyśnika: stop aluminium

Kanlux AVIA MTH is a floodlight with a replaceable light source with an E40 screw. Owing to the high rating of tightness IP65, it is a good choice for lighting large venues, e.g. pitches, halls, parking lots, squares, etc.

Enclosure material: aluminum alloy
Protective glass material: Tempered glass
Reflector material: aluminum alloy

HB MASTER LED

OPRAWA LED HIGH BAY ► HIGH-BAY LED LIGHT FITTING



HB MASTER LED 100W



HB MASTER LED 100W



HB MASTER LED 150W



HB MASTER LED 200W

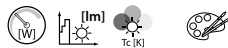

HB MASTER LED 100W	28530	5905339285300	100	13000	4000	czarny black
HB MASTER LED 150W	28531	5905339285317	150	19500	4000	czarny black
HB MASTER LED 200W	28532	5905339285324	200	26000	4000	czarny black

[V] 220-240 AC	[Hz] 50/60	[°] 120	[lm] ≥15000	[h] 50000	[Ra] ≥80	[SMD]	[IK] 08	[mm] 0,4	[mm] 1
[IP] 65	[°C] -30+40	[CE]	[EAC]	[Kanlux]	[G]	[A]	[A]	[A]	[A]



IP 65

HIGH efficacy

BRANDED components

5+ WARRANTY 5 years

Kanlux HB MASTER to profesjonalne oprawy oświetleniowe typu HIGH BAY. Oprawy te mają szereg akcesoriów, dzięki którym zmodyfikujesz oprawę. Uchwyty, klosze, soczewki, siatki ochronne - wszystko aby spełnić wymagania każdej inwestycji.

5 lat Gwarancji na warunkach oświadczenia gwarancyjnego, dostępnego na stronie internetowej

Dodatkowe akcesoria dla HB MASTER 200W dostępne na indywidualne zamówienie po konsultacji z działem sprzedaży

Materiał obudowy: stop aluminium
Materiał szyby ochronnej: szkło hartowane

The Kanlux HB MASTER floodlight is one of the professional HIGH BAY fixture range. These fixtures have a variety of accessories which will allow you to modify them. Handles, lampshades, lenses, protective nets - everything to meet the requirements of any investment.

5 years Warranty under the terms of the warranty statement, available on our website
Additional accessories for HB MASTER 200W are available on request after consulting the sales department.

Enclosure material: aluminum alloy
Protective glass material: Tempered glass

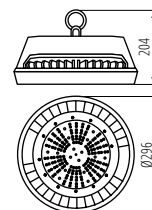

HB MASTER LED 100W, HB MASTER LED 150W

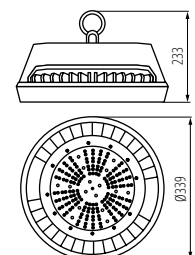

HB MASTER LED 200W

HB MASTER LED

OPRAWA LED HIGH BAY ► HIGH-BAY LED LIGHT FITTING



HBM BRACKET 100/150/200W



HBM GRID 100/150/200W



HBM LENS 60D 100/150/200W



HBM LENS 90D 100/150/200W



HBM PC 100D 100/150W



HBM REF ALU100/150W



HBM REF PC100/150W



HBM PC 100D 200W



HBM REF ALU200W



HBM REF PC200W

AKCESORIA ► ACCESSORIES

HBM BRACKET 100/150W	28543	Uchwyt montażowy do oprawy HB MASTER 100W, 150W Assembly handle for HB MASTER 100W & 150W fixtures
HBM GRID 100/150W	28545	Siatka ochronna do oprawy HB MASTER 100W, 150W Protective net for HB MASTER 100W & 150W fixtures
HBM LENS 60D 100/150W	28537	Soczewka 60 stopni do oprawy HB MASTER 100W, 150W 60-degree lens for HB MASTER 100W & 150W fixtures
HBM LENS 90D 100/150W	28538	Soczewka 90 stopni do oprawy HB MASTER 100W, 150W 90-degree lens for HB MASTER 100W & 150W fixtures
HBM PC 100D 100/150W	28539	Ostona PC zapewniająca IK10 do oprawy HB MASTER 100W, 150W PC cover providing IK10 for HB MASTER 100W & 150W fixtures
HBM REF ALU100/150W	28533	Klosz ALU do oprawy HB MASTER 100W, 150W ALU lampshade for HB MASTER 100W & 150W fixtures
HBM REF PC100/150W	28535	Klosz PC do oprawy HB MASTER 100W, 150W PC lampshade for HB MASTER 100W & 150W fixtures
HBM BRACKET 200W	28544	Uchwyt montażowy do oprawy HB MASTER 200W Assembly handle for HB MASTER 200W fixture
HBM GRID 200W	28546	Siatka ochronna do oprawy HB MASTER 200W Protective net for HB MASTER 200W fixture
HBM LENS 60D 200W	28540	Soczewka 60 stopni do oprawy HB MASTER 200W 60-degree lens for HB MASTER 200W fixture
HBM LENS 90D 200W	28541	Soczewka 90 stopni do oprawy HB MASTER 200W 90-degree lens for HB MASTER 200W fixture
HBM PC 100D 200W	28542	Ostona PC zapewniająca IK10 do oprawy HB MASTER 200W PC cover providing IK10 for HB MASTER 200W fixture
HBM REF ALU200W	28534	Klosz ALU do oprawy HB MASTER 200W ALU lampshade for HB MASTER 200W fixture
HBM REF PC200W	28536	Klosz PC do oprawy HB MASTER 200W PC lampshade for HB MASTER 200W fixture

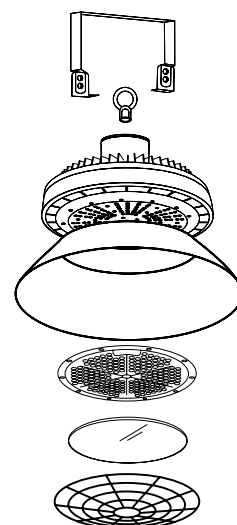

HB PRO LED HI

OPRAWA LED HIGH BAY ► HIGH-BAY LED LIGHT FITTING

NEW



HB PRO LED HI 100W



HB PRO LED HI 150W



HB PRO LED HI 200W

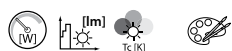

HB PRO LED HI 100W-NW	27155	5905339271556	100	14000	4000	czarny black
HB PRO LED HI 150W-NW	27156	5905339271563	150	21750	4000	czarny black
HB PRO LED HI 200W-NW	27157	5905339271570	200	29250	4000	czarny black

[V]	[Hz]	[°]	[lm]	[h]	Tc (K)	ellipse
220-240 AC	50	90	≥15000	30000	4000	≤ 6x MacAdam
Ra ≥80	SMD				IP 65	
	1m				-20+40	

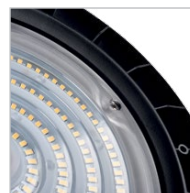

Kanlux HB PRO HI to oprawy typu „High Bay”. Oprócz energooszczędności, jaką gwarantuje zastosowana w nich technologia LED, cechuje je też niezwykle duża trwałość i wysoki stopień szczelności IP65. Idealnie sprawdzą się w wysokich halach magazynowych, produkcyjnych czy sklepowych. Dodatkowym atutem tych opraw jest zintegrowana puszka przyłączeniowa, która usprawnia montaż. Kanlux HB PRO HI to również duże strumienie świetlne i wysoka skuteczność na poziomie niemal 150 lumenów z Wata.

5 lat Gwarancji na warunkach oświadczenia gwarancyjnego, dostępnego na stronie internetowej

Materiał obudowy: stop aluminium

Materiał szyby ochronnej: tworzywo sztuczne

Kanlux HB PRO LED are “High Bay” luminaires. Apart from the energy efficiency of the applied LED technology, they are characterised by extremely high durability and tightness of IP65. It is an excellent choice for high storage, production or shop halls. An additional advantage of these luminaires is an integrated junction box which makes the installation easier. Kanlux HB PRO HI also offers both a high luminous flux and a high luminous efficiency of 150 lm/W.

5 years Warranty under the terms of the warranty statement, available on our website

Enclosure material: aluminum alloy

Protective glass material: plastic

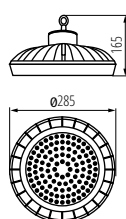

HB PRO LED HI 100W

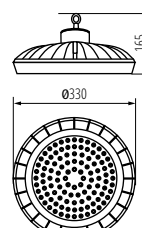

HB PRO LED HI 150W

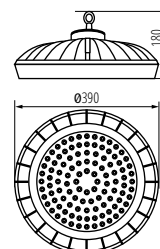

HB PRO LED HI 200W

HB PRO LED HI

OPRAWA LED HIGH BAY ► HIGH-BAY LED LIGHT FITTING



HB PRO LED HI 200W



HBPH LENS 120D 100W



HBPH LENS 120D 150W



HBPH LENS 120D 200W



HBPH LENS 60D 100W



HBPH LENS 60D 150W



HBPH LENS 60D 200W



HBPH GRID 100W



HBPH GRID 150W



HBPH GRID 200W

AKCESORIA ► ACCESSORIES

HBPH LENS 120D 100W	33193	5905339331939	Soczewka 120 stopni do oprawy HB PRO HI 100W, HBPH LENS 120D 100W (33193) 120-degree lens for the HB PRO HI 100W, HBPH LENS 120D 100W light fittings (33193)
HBPH LENS 120D 150W	33194	5905339331946	Soczewka 120 stopni do oprawy HB PRO HI 150W, HBPH LENS 120D 150W (33194) 120-degree lens for the HB PRO HI 150W, HBPH LENS 120D 150W light fittings (33194)
HBPH LENS 120D 200W	33195	5905339331953	Soczewka 120 stopni do oprawy HB PRO HI 200W, HBPH LENS 120D 200W (33195) 120-degree lens for the HB PRO HI 200W, HBPH LENS 120D 200W light fittings (33195)
HBPH LENS 60D 100W	33190	5905339331908	Soczewka 60 stopni do oprawy HB PRO HI 100W, HBPH LENS 60D 100W (33190) 60-degree lens for the HB PRO HI 100W, HBPH LENS 60D 100W light fittings (33190)
HBPH LENS 60D 150W	33191	5905339331915	Soczewka 60 stopni do oprawy HB PRO HI 150W, HBPH LENS 60D 150W (33191) 60-degree lens for the HB PRO HI 150W, HBPH LENS 60D 150W light fittings (33191)
HBPH LENS 60D 200W	33192	5905339331922	Soczewka 60 stopni do oprawy HB PRO HI 200W, HBPH LENS 60D 200W (33192) 60-degree lens for the HB PRO HI 200W, HBPH LENS 60D 200W light fittings (33192)
HBPH GRID 100W	33196	5905339331960	Siatka ochronna do oprawy HB PRO LED HI 100W-NW, HBPH GRID 100W, srebrna (33196) Protective grid for the HB PRO LED HI 100W-NW, HBPH GRID 100W light fittings, silver (33196)
HBPH GRID 150W	33197	5905339331977	Siatka ochronna do oprawy HB PRO LED HI 150W-NW, HBPH GRID 150W, srebrna (33197) Protective grid for the HB PRO LED HI 150W-NW, HBPH GRID 150W light fittings, silver (33197)
HBPH GRID 200W	33198	5905339331984	Siatka ochronna do oprawy HB PRO LED HI 200W-NW, HBPH GRID 200W, srebrna (33198) Protective grid for the HB PRO LED HI 200W-NW, HBPH GRID 200W light fittings, silver (33198)

STREET LED

OPRAWA PARKINGOWA LED ► PARKING LIGHTING LED



STREET LED 4000



STREET LED 4000



STREET LED 8000



STREET LED 12000



STREET LED 4000 NW	27330	5905339273307	30	3900	4000	X100/Y145	szary grey
STREET LED 8000 NW	27331	5905339273314	60	7800	4000	X100/Y145	szary grey
STREET LED 12000 NW	27332	5905339273321	90	11700	4000	X100/Y145	szary grey

[V] 220-240 AC	[Hz] 50/60	[lm] ≥20000	[h] 35000	ellipse ≤6° Max/dam	Ra ≥70	SMD	⊕	IP 65
🏠	🌡️ -35÷40	🔌	[m] 0,4	[mm] 1	📏 1m	🚫	CE	ERAC

AKCESORIA ► ACCESSORIES

STREET LED ADTR 15D	27333	5905339273338	Regulowany adapter do opraw parkingowych, STREET LED ADTR 15D, szary (27333) Adjustable adaptor intended for installing STREET LED parking fixtures on vertical posts with Ø 60mm to Ø 63mm diameter ends.				
---------------------	--------------	---------------	--	--	--	--	--

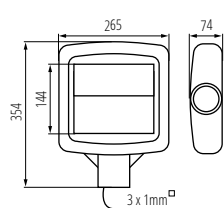

STREET LED 4000

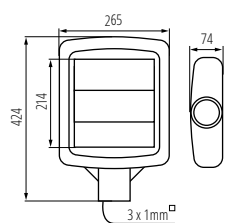

STREET LED 8000

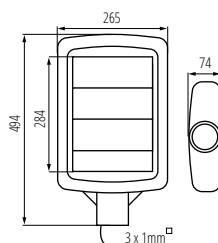

STREET LED 12000



STREET LED ADTR 15D

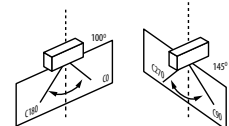

Kanlux STREET LED wyposażone są w diody bardzo wysokiej jakości, które umieszczone są na wymiennych modułach. Ich skuteczność to 130 lumenów z Wata! Ich nowoczesny design bardzo dobrze komponuje się z przestrzenią miejską. Do opraw polecamy adapter ADTR15D.

Materiał obudowy: stop aluminium
Materiał klosza: tworzywo sztuczne

The Kanlux STREET LED is equipped with very-high quality LED's, which are fitted in replaceable modules. Their efficacy is at least 130 lumen for 1 Watt! Their modern design fits in very well with urban spaces. We recommend the ADTR15D adapter for these fixtures.

Enclosure material: aluminum alloy
Lampshade material: plastic

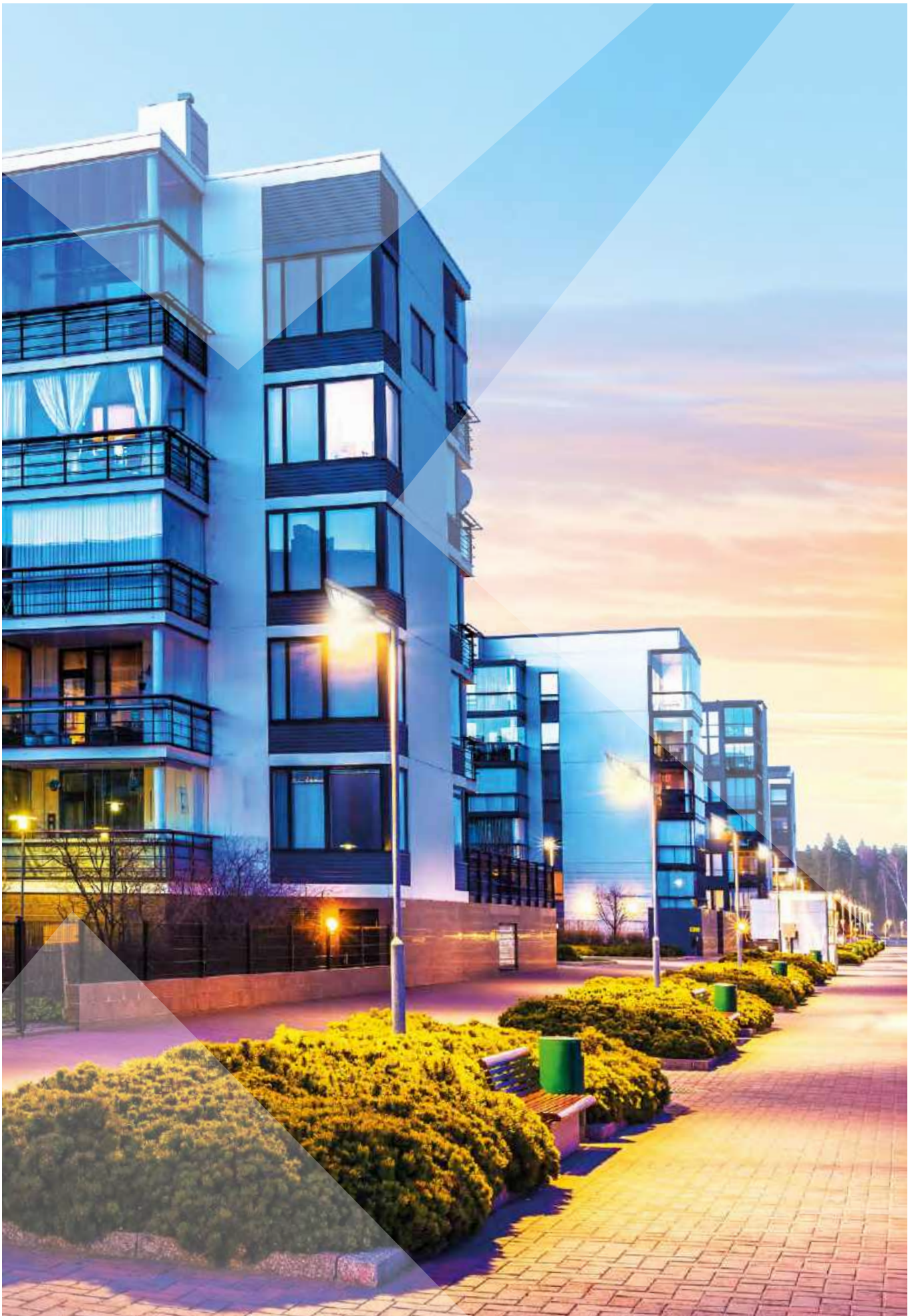

Kanlux BART EL

OPRAWA ELEWACYJNA ► FACADE LUMINAIRE



BART EL-235



Kanlux BART EL to oprawa natynkowa, która świetnie wkomponuje się zarówno w elewację nowoczesnego budynku jak i zabudowania o bardziej klasycznej stylistyce. Stopień szczelności IP54, jaki posiada oprawa Kanlux BART EL gwarantuje odporność na działanie czynników atmosferycznych.

Materiał obudowy: stop aluminium
Materiał szyby ochronnej: szkło hartowane

Kanlux BART EL is a façade luminaire which perfectly blends into a modern building and constructions of a more classic style. The rating of tightness (IP54) of Kanlux BART EL luminaire ensures resistance to weather conditions.

Enclosure material: aluminum alloy
Protective glass material: Tempered glass

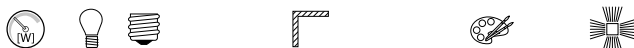

BART EL-235	07080	5905339070807	2 x max 35	PAR16	GU10	do nadbudowania na ścianie wall mounted	szary grey	góra i dół up and down
BART EL-260	07082	5905339070821	2 x max 60	A60	E27	do nadbudowania na ścianie wall mounted	szary grey	góra i dół up and down

[V] 220-240 AC	[Hz] 50/60	Light bulb icon	Grounding icon	IP 54	0,5m	Temperature icon -20+35	Mounting icon
Energy efficiency icon	Beam spread icon 1+2,5	CE	ERAC	Kanlux logo and energy efficiency class icons (A+, A, A-, B, C, D, E)			

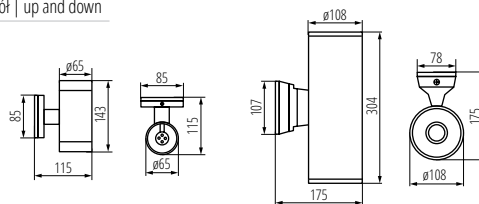

BART EL-235

BART EL-260

Kanlux LART EL

OPRAWA ELEWACYJNA ► FACADE LUMINAIRE



LART EL-160-GR



LART EL-260-GR



Seria elewacyjnych opraw Kanlux LART to surowa i jednocześnie klasyczna linia opraw fasadowych w obudowie wykonanej z aluminium. Powierzchnia zewnętrzna oprawy wykończona jest w kolorze antracytowym. Kanlux LART perfekcyjnie prezentują się zarówno pojedynczo, jak i w zestawieniu kilku opraw. Subtelnie tworzą lub dopełniają świetlne aranżacje na tarasach czy elewacjach budynków.

Materiał obudowy: stop aluminium
Materiał szyby ochronnej: szkło

A series of facade Kanlux LART luminaires is a raw and at the same time classic line of facade luminaires in a casing made of aluminium. The external surface of the luminaire is completed in a graphite colour. Kanlux LART look perfect both on a single basis and in combination of several luminaires - subtly complementing light arrangements on terraces or facades of buildings.

Enclosure material: aluminum alloy
Protective glass material: glass

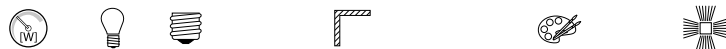

LART EL-160-GR	29832	5905339298324	max 60	GLS/CFL/LED	E27	do nadbudowania na ścianie wall mounted	antracyt anthracite	dół down
LART EL-260-GR	29833	5905339298331	2x max 60	GLS/CFL/LED	E27	do nadbudowania na ścianie wall mounted	antracyt anthracite	góra i dół up and down

[V] 220-240 AC	[Hz] 50	Light bulb icon	Grounding icon	IP 54	0,5m	Temperature icon -20+35	Mounting icon
Energy efficiency icon	Beam spread icon 0,5+1,5	CE	ERAC	Kanlux logo and energy efficiency class icons (A+, A, A-, B, C, D, E)			

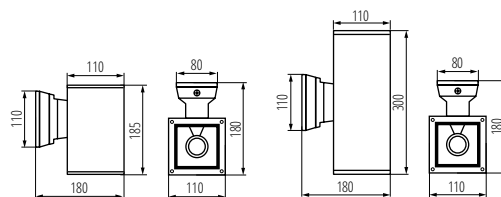

LART EL-160

LART EL-260

Kanlux MAGRA EL

OPRAWA ELEWACYJNA ► FACADE LUMINAIRE



MAGRA EL-135



MAGRA EL-235



Kanlux MAGRA EL to ścienny kinkiet zewnętrzny w szarym, neutralnym kolorze. Zbudowany ze stali nierdzewnej i szkła hartowanego zapewnia trwałość i komfort użytkowania.

Materiał obudowy: stal nierdzewna
Materiał szyby ochronnej: szkło hartowane

Kanlux MAGRA EL is an external sconce in gray, neutral colour. It is made of stainless steel and tempered glass, ensuring durability and comfort of use.

Enclosure material: stainless steel
Protective glass material: Tempered glass



MAGRA EL-135	18010	5905339180100	1 x max 35	PAR16	GU10	do nadbudowania na ścianie wall mounted	stal nierdzewna stainless steel	góra Top
MAGRA EL-235	18011	5905339180117	2 x max 35	PAR16	GU10	do nadbudowania na ścianie wall mounted	stal nierdzewna stainless steel	góra i dół up and down

[V] 220-240 AC	[Hz] 50/60	Light bulb icon	Grounding symbol	IP 44	Light bulb icon	House icon	Temperature icon -20+35	Mounting icon
Light bulb icon	Light bulb icon	CE	ERL	Kanlux logo	Light bulb icon	Light bulb icon	Light bulb icon	Light bulb icon
Light bulb icon	Light bulb icon	Light bulb icon	Light bulb icon	Light bulb icon	Light bulb icon	Light bulb icon	Light bulb icon	Light bulb icon

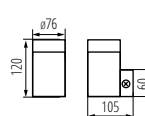

MAGRA EL-135

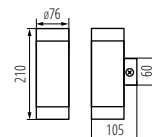

MAGRA EL-235

Kanlux DARSA EL

OPRAWA ELEWACYJNA ► FACADE LUMINAIRE



DARSA EL-135L-UP



DARSA EL-235T-UP



Kanlux DARSA to ponadczasowa i uniwersalna oprawa ogrodowa ze stali nierdzewnej. Wymienne źródła światła z trzonkiem GU10 w oprawie umieszczone są za osłoną z hartowanego szkła.

Materiał obudowy: stop metali niekorodujących
Materiał klosza: szkło hartowane
Materiał szyby ochronnej: szkło

Kanlux DARSA is a timeless and universal garden luminaire made of stainless steel. The replaceable light sources with GU10 screw are located in the luminaire behind a tempered glass cover.

Enclosure material: non-corrosive metals alloy
Lampshade material: Tempered glass
Protective glass material: glass



DARSA EL-135L-UP	19120	5905339191205	max 35	PAR16	GU10	do nadbudowania na ścianie wall mounted	stal nierdzewna stainless steel	dół down
DARSA EL-235T-UP	19121	5905339191212	2 x max 35	PAR16	GU10	do nadbudowania na ścianie wall mounted	stal nierdzewna stainless steel	góra i dół up and down

[V] 220-240 AC	[Hz] 50/60	Light bulb icon	Grounding symbol	IP 44	House icon	Temperature icon -20+35	Mounting icon
Light bulb icon	Light bulb icon	CE	ERL	Kanlux logo	Light bulb icon	Light bulb icon	Light bulb icon
Light bulb icon	Light bulb icon	Light bulb icon	Light bulb icon	Light bulb icon	Light bulb icon	Light bulb icon	Light bulb icon

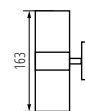

DARSA EL-235T-UP



DARSA EL-135L-UP

Kanlux ZEW EL

OPRAWA ELEWACYJNA ► FACADE LUMINAIRE



ZEW EL-235J-B



ZEW EL-235U-B



ZEW EL-235J-GR



ZEW EL-235U-GR

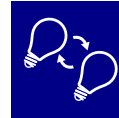

Oprawy Kanlux ZEW doskonale nadają się do oświetlenia elewacji budynków różnego typu, a dzięki strumieniowi światła, który skierowany jest zarówno w górę jak i w dół, kreślą one na elewacji piękne, dekoracyjne akcenty świetlne. Wysoka klasa szczelności IP44 sprawia, że oprawy można montować w miejscach bezpośrednio narażonych na działanie czynników atmosferycznych.

Materiał obudowy: stop aluminium
Materiał szyby ochronnej: szkło hartowane

Kanlux ZEW luminaires are a perfect solution for illuminating facades of buildings of various types, while the light flux directed both upwards and downwards, they create one beautiful decorative light accents on the façade. Owing to the high class of tightness (IP44), the luminaires can be mounted in places directly exposed to weather conditions.

Enclosure material: aluminum alloy
Protective glass material: Tempered glass



ZEW EL-235J-B	22440	5905339224408	2 x max 35	PAR16	GU10	do nadbudowania na ścianie wall mounted	czarny black	góra i dół up and down
ZEW EL-235U-B	22441	5905339224415	2 x max 35	PAR16	GU10	do nadbudowania na ścianie wall mounted	czarny black	góra i dół up and down
ZEW EL-235J-GR	22442	5905339224422	2 x max 35	PAR16	GU10	do nadbudowania na ścianie wall mounted	szary grey	góra i dół up and down
ZEW EL-235U-GR	22443	5905339224439	2 x max 35	PAR16	GU10	do nadbudowania na ścianie wall mounted	szary grey	góra i dół up and down

220-240 AC	50/60	PAR16			IP 44	0,5m	-20+35
	1+2,5						

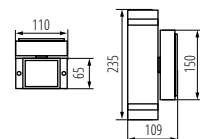

ZEW EL-235J

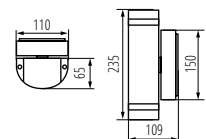

ZEW EL-235U

REKA LED



OPRAWA ELEWACYJNA ► FACADE LUMINAIRE



REKA LED EL 7W-L-GR



REKA LED EL 7W-O-GR



REKA LED EL 7W-L-W



REKA LED EL 7W-O-W



Podstawową zaletą Kanlux REKA LED jest unikatowy wizualnie efekt świetlny, który sami stworzymy po włączeniu. Dzięki skrzydłom umieszczonym na dole i na górze oprawy sami zdecydujemy o kierunku i szerokości strumienia świetlnego. Lampa Kanlux REKA świeci w dwóch kierunkach - góra i dół - a strumień świetlny możemy ustawić niezależnie od siebie tworząc na przykład idealnie cienką świetlną linię na górze, a na dole ustawiając szerokie świetlne kaskady, które będą spływać od lampy do podłoża. Kanlux REKA LED znajdzie zastosowanie przy oświetleniu elewacji budynków, tarasów, balkonów czy zewnętrznych ścian altan.

Regulacja kąta świecenia

Materiał obudowy: stop aluminium

The main advantage of the Kanlux REKA LED is an interesting visual effect, which the lamp creates when switched on, as well as the free luminous flux adjustment by means of masking flaps. The Kanlux REKA LED can be used for building-facade lighting.

Beam-angle adjustment

Enclosure material: aluminum alloy



REKA LED EL 7W-L-GR	28990	5905339289902	7	max 360	4000	do nadbudowania na ścianie wall mounted	grafitowy graphite	góra i dół up and down
REKA LED EL 7W-O-GR	28991	5905339289919	7	max 380	4000	do nadbudowania na ścianie wall mounted	grafitowy graphite	góra i dół up and down
REKA LED EL 7W-L-W	28992	5905339289926	7	max 500	4000	do nadbudowania na ścianie wall mounted	biały white	góra i dół up and down
REKA LED EL 7W-O-W	28993	5905339289933	7	max 510	4000	do nadbudowania na ścianie wall mounted	biały white	góra i dół up and down

[V] 220-240 AC	[Hz] 50/60	[°] max 90	[h] ≥20000	[h] 30000	[lm] ≤6x Maxlum	Ra ≥80	COB	[Symbol]	[Symbol]	[Symbol]	IP 54
0,5m	[Symbol]	[Symbol]	[Symbol]	[Symbol]	[Symbol]	[Symbol]	CE	EAC	Kanlux		

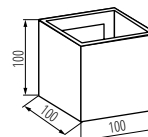

REKA LED EL-L

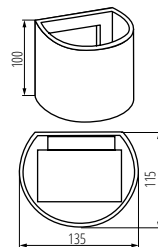

REKA LED EL-O

Kanlux GARTO LED

OPRAWA ELEWACYJNA ► FACADE LUMINAIRE



GARTO LED EL 8W-GR



Kanlux GARTO to oprawy elewacyjne, które charakteryzują się prostym i atrakcyjnym designem. Mogą być stosowane jako oprawa do wnętrz (posiadają odpowiedni współczynnik CRI), jednocześnie można stosować je na elewacjach budynku (IP54). W oprawie Kanlux GARTO światło na elewację pada od góry i od dołu będąc równomiernie rozproszone w obu kierunkach.

Materiał obudowy: stop aluminium

Materiał szyby ochronnej: tworzywo sztuczne

Kanlux GARTO are facade fittings characterized by simple and attractive design. They can be used as a fitting for interiors (they have an appropriate CRI coefficient), at the same time they can be used on building facades (IP54). In Kanlux GARTO holder light falls on facade from upwards and from downwards being evenly diffused in both directions.

Enclosure material: aluminum alloy

Protective glass material: plastic

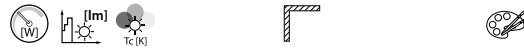

GARTO LED EL 8W-GR	29270	5905339292704	8	300	4000	do nadbudowania na ścianie wall mounted	grafitowy graphite
GARTO LED EL 8W-W	29271	5905339292711	8	350	4000	do nadbudowania na ścianie wall mounted	biały white

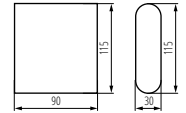

GARTO LED EL 8W

[V] 220-240 AC	[Hz] 50/60	≥25000	25000	ellipsoide ≤ 6x/Maxdiam	Ra ≥80	SMD	IP 54	0,5m	-15+40	IK 09	0,5+1,5	CE	ERC	Kanlux
-------------------	---------------	--------	-------	----------------------------	-----------	-----	----------	------	--------	----------	---------	----	-----	--------

Kanlux ONSTAR LED

OPRAWA NAŚCIENNA ► SURFACE-MOUNTED LIGHT FITTING



ONSTAR LED GR



Kanlux ONSTAR to oprawa natynkowa w grafitowym kolorze, cechująca się nowoczesnym wzornictwem i energooszczędnością. Dzięki specyficznemu kształtowi panelu frontowego wydaje się, iż oprawa płasko przylega do ściany. Oprawa doskonale spełnia swoją funkcję jako oświetlenie dekoracyjne lub doświetlające schody czy też ogólną przestrzeń wokół budynku.

Materiał obudowy: tworzywo sztuczne

Materiał szyby ochronnej: PC

Kanlux ONSTAR is a facade luminaire in graphite colour, characterised by modern design and energy efficiency. Due to the specific shape of the front panel, the luminaire seems to lie flat against the wall. The luminaire perfectly fulfills its function as a decorative lighting, additional stair lighting or illumination of spaces around buildings.

Enclosure material: plastic

Protective glass material: PC

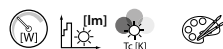

ONSTAR LED-GR	22760	5905339227607	1,7	60	6500	szary grey
---------------	-------	---------------	-----	----	------	--------------

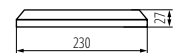
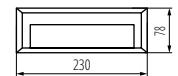

ONSTAR LED

[V] 220-240 AC	[Hz] 50/60	≥15000	20000	Ra ≥80	SMD	IP 65	0,2m	-20+35	IK 09	0,5+1,5	CE	ERC	Kanlux
-------------------	---------------	--------	-------	-----------	-----	----------	------	--------	----------	---------	----	-----	--------

Kanlux

CROTO LED

OPRAWA NAŚCIENNA ► SURFACE-MOUNTED LIGHT FITTING



CROTO LED-GR-L



CROTO LED-GR-L | **22770** | 5905339227706 | 1,1 | 30 | 6500 | szary | grey

[V] 220-240 AC	[Hz] 50/60	≥15000	(h) 20000	all ppe ≤ 6x/100cd/m	Ra ≥80	SMD	⊗	⊗	⊗
IP 65	0,2m	⊕	⊕	⊕	⊕	0,5+1,5	CE	ERC	Kanlux

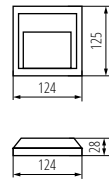

CROTO LED-GR-L

Kanlux

LINDA LED

OPRAWA DO WBUDOWANIA ► RECESSED LIGHT FITTING



LINDA LED-J02

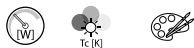

LINDA LED-J02 | **04681** | 5905339046819 | 1,2 | 3800-4200 | szary | grey

[V] 220-240 AC	[Hz] 50/60	(h) 20000	⊗	⊗	⊗	IP 65	0,2m		
⊕	⊕	⊕	⊕	⊕	⊕	0,75	CE	ERC	Kanlux

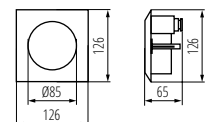

LINDA LED-J02



Kanlux CROTO to oprawa natynkowa w grafitowym kolorze, cechująca się nowoczesnym wzornictwem i energooszczędnością. Dzięki specyficznemu kształtowi panelu frontowego wydaje się, iż oprawa płasko przylega do ściany. Oprawa doskonale spełnia swoją funkcję jako oświetlenie dekoracyjne, lub doświetlające schody czy też ogólną przestrzeń wokół budynku.

Materiał obudowy: tworzywo sztuczne

Materiał szyby ochronnej: PC

Kanlux CROTO is a façade luminaire in graphite colour, characterised by modern design and energy efficiency. Due to the specific shape of the front panel, the luminaire seems to lie flat against the wall. The luminaire perfectly fulfills its function as a decorative lighting, additional stair lighting or illumination of spaces around buildings.

Enclosure material: plastic

Protective glass material: PC



Kanlux LINDA LED to oprawa do wbudowania z kategorii oświetlenia akcentowego. Można ją montować zarówno wewnątrz, jak i na zewnątrz budynków (IP54). Jest to idealne rozwiązanie do dekoracyjnego podświetlania schodów lub podestów.

możliwość zasilenia przelotowego do 5 opraw
w zestawie plastikowa puszka do zabudowy

Kanlux LINDA LED is a luminaire for embedding, classified as accent lighting. It can be installed both indoors and outdoors (IP54). A perfect choice for decorative lighting of stairs and platforms.

optional feed-through power supply for up to 5 light fixtures
included plastic junction box for installation

Kanlux

DORA LED

OPRAWA DO WBUDOWANIA ► RECESSED LIGHT FITTING



DORA LED-J01



Kanlux DORA LED to oprawa do wbudowania z kategorii oświetlenia akcentowego. Można ją montować zarówno wewnątrz, jak i na zewnątrz budynków (IP54). Jest to idealne rozwiązanie do dekoracyjnego podświetlenia schodów lub podestów.

możliwość zasilania przelotowego do 5 opraw
w zestawie plastikowa puszka do zabudowy

Kanlux DORA LED is a luminaire for embedding, classified as accent lighting. It can be installed both indoors and outdoors (IP54). A perfect choice for decorative lighting of stairs and platforms.

optional feed-through power supply for up to 5 light fixtures
included plastic junction box for installation



DORA LED-J01 | **04680** | 5905339046802 | 1,2 | 3800-4200 | szary | grey

[VI] 220-240 AC	[Hz] 50/60	[h] 20000				IP 65	 0,2m
	[°C] -20+35			[mm²] 0,75	CE	ERC	

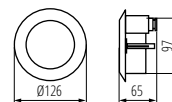

DORA LED-J01



TAXI SMD

OPRAWA DO WBUDOWANIA ► RECESSED LIGHT FITTING



TAXI SMD L C/M



TAXI SMD P C/M



Kanlux TAXI SMD to ledowa oprawa akcentowa. Można ją montować zarówno wewnątrz, jak i na zewnątrz budynków (IP54). Jest to idealne rozwiązanie do dekoracyjnego podświetlenia schodów lub podestów.

Materiał obudowy: metal
Materiał szyby ochronnej: szkło
Materiał panelu/ramki: stal nierdzewna

Kanlux TAXI SMD is a LED accent luminaire. It can be installed both indoors and outdoors (IP54). A perfect choice for decorative lighting of stairs and platforms.

Enclosure material: Metal
Protective glass material: glass
Panel/frame material: stainless steel



TAXI SMD L C/M-WW	26460	5905339264602	0,6	10	3000	chrom mat chrome matte
TAXI SMD L C/M-NW	26461	5905339264619	0,6	10	4000	chrom mat chrome matte
TAXI SMD P C/M-WW	26462	5905339264626	0,6	10	3000	chrom mat chrome matte
TAXI SMD P C/M-NW	26463	5905339264633	0,6	10	4000	chrom mat chrome matte

[V] 220-240 AC	[Hz] 50/60	[h] ≥10000 20000	[lm] ≥80	Ra ≥80	SMD	IP 54	0,1m	CE	ERL	Kanlux
[m] 0,22	[mm] 0,75									

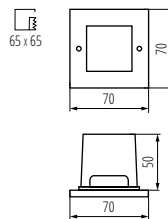

TAXI SMD L

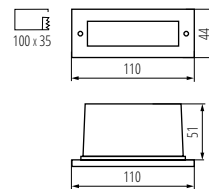

TAXI SMD P



Kanlux

TURRO LED

OPRAWA NAJAZDOWA ► IN-GROUND LIGHTING FITTING



TURRO LED



Kanlux TURRO LED to oprawa dogruntowa. Iluminacja fasad budynków czy elementów krajobrazu to główne zastosowanie tych opraw. Zastowane soczewki zapewniają wąski kąt świecenia, przez co oprawa idealnie oświetla powierzchnie otwarte, ale również ściany narożne, wnęki okienne, nisze, kolumny czy maszty flagowe.

Soczewkowy układ optyczny
Materiał obudowy: stop aluminium
Materiał szyby ochronnej: szkło hartowane

Kanlux TURRO LED is an in-ground fixture. Illumination of building façades or landscape elements is the main application of these fixtures. The lenses used here provide a narrow beam angle, so that the fixture perfectly illuminates open areas, but also corner walls, window recesses, niches, columns or flag poles.

Optical lens system
Enclosure material: aluminum alloy
Protective glass material: Tempered glass

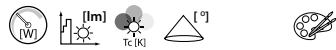

TURRO LED 30W-NW | 18982 | 5905339189820 | 30 | 3000 | 4000 | 40 | stal nierdzewna | stainless steel

[V] 220-240 AC	[Hz] 50/60	[h] ≥15000	[h] 25000	[lm] ≥15000	Ra ≥70	SMD	[mm] 0,19	[mm] 1	lm 100	IP 67	1m	1m
[°C] -25+35	[kN]20	[kN]10	[mm] 1	[mm] 1	[mm] 1	[mm] 1	[mm] 1	[mm] 1	[mm] 1	CE	EAC	Kanlux

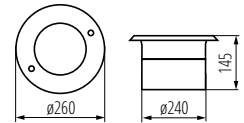

TURRO LED

Kanlux

XARD DL

OPRAWA NAJAZDOWA ► IN-GROUND LIGHTING FITTING



XARD DL-40



Oprawa dogruntowa Kanlux XARD charakteryzuje się największym stopniem odporności na uszkodzenia mechaniczne - tzw. „wandaloodporność” - IK10. Dodając do tego wysoki stopień szczelności IP67 otrzymujemy oprawę która jest świetnym rozwiązaniem dla oświetlenia elewacji budynków, skwerów, tarasów, parków, ścieżek, pasaży, podjazdów, schodów itp.

puszka montażowa w komplecie
całkowita długość źródła światła max 110mm
Materiał obudowy: stop aluminium
Materiał szyby ochronnej: szkło hartowane
Materiał panelu/ramki: stal nierdzewna

Kanlux XARD ground recessed luminaire is characterised by the highest level of resistance to mechanical damage - the so-called "vandal-resistance" - IK10. Add to this a high rating of tightness (IP67) and we get a luminaire which is a great solution for lighting façades of buildings, squares, terraces, parks, paths, passages, driveways, stairs, etc.

Junction box included
total light source length max 110 mm
Enclosure material: aluminum alloy
Protective glass material: Tempered glass
Panel/frame material: stainless steel



XARD DL-40 | 07195 | 5905339071958 | max 40 | A60 | E27 | stal nierdzewna | stainless steel

[V] 220-240 AC	[Hz] 50/60	[lm] max 40	[lm] A60	[lm] E27	[lm] stal nierdzewna	[lm] stainless steel	[lm] stal nierdzewna	[lm] stainless steel	[lm] stal nierdzewna	[lm] stainless steel	[lm] stal nierdzewna	[lm] stainless steel
IK 10	[kN]20	[kN]1	[kN]1	[kN]1	[kN]1	[kN]1	[kN]1	[kN]1	[kN]1	CE	EAC	Kanlux

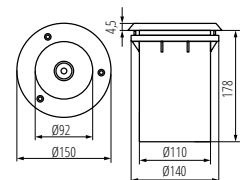

XARD DL-40

Kanlux BERG DL

OPRAWA NAJAZDOWA ► IN-GROUND LIGHTING FITTING



BERG DL-350



BERG DL-350	07170	5905339071705	max 35	PAR16	GU10	stal nierdzewna	stainless steel
BERG DL-35L	07171	5905339071712	max 35	PAR16	GU10	stal nierdzewna	stainless steel

[V] 220-240 AC	[Hz] 50/60	PAR16	IP 67	0,5m	°C -20+35	IK 08	1+2,5	CE	ERAC	Kanlux
--------------------------	----------------------	--------------	-----------------	-------------	---------------------	-----------------	--------------	-----------	-------------	---------------



BERG DL-35L



Kanlux BERG to wytrzymała oprawa dogruntowa z wymiennym źródłem światła o trzonku GU10. Świetnik sprawdza się do podświetlania podjazdów, alejek, chodników itp. Wykonana jest z materiałów najwyższej jakości, dzięki czemu odporna jest na nacisk do 2 ton.

puszka montażowa w komplecie
możliwość łączenia przelotowego opraw
ułatwiona wymiana źródła światła
Materiał obudowy: stal
Materiał szyby ochronnej: szkło hartowane
Materiał panelu/ramki: stal nierdzewna

Kanlux BERG is a durable ground-recessed luminaire using a replaceable light source with an GU10 screw. It works great in illumination of driveways, alleys, sidewalks etc. It is manufactured of best quality materials owing to which can resist pressure up to 2 tons.

Junction box included
optional pass-through connection of light fixtures
easier light source replacement
Enclosure material: steel
Protective glass material: Tempered glass
Panel/frame material: stainless steel

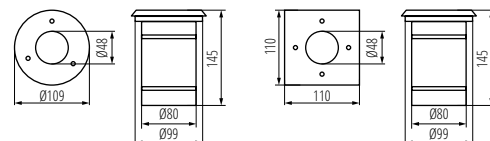

BERG DL-350

BERG DL-35L

Kanlux GORDO LED14

OPRAWA NAJAZDOWA ► IN-GROUND LIGHTING FITTING



GORDO LED14 SMD-0



GORDO LED14 SMD-0	22050	5905339220509	0,7	40	6500	stal nierdzewna	stainless steel
GORDO LED14 SMD-L	22051	5905339220516	0,7	40	6500	stal nierdzewna	stainless steel

[V] 220-240 AC	[Hz] 50	≥10000	20000	Ra ≥80	SMD	IP 66	0,1m	IK 10	0,3	1	CE
--------------------------	-------------------	---------------	--------------	------------------	------------	-----------------	-------------	-----------------	------------	----------	-----------



GORDO LED14 SMD-L



Kanlux GORDO LED14 to oprawa najazdowa ze zintegrowanym źródłem światła LED przeznaczona do wbudowania w podłoże. Wykonana jest z materiałów najwyższej jakości, dzięki czemu odporna jest na nacisk do 2 ton.

puszka montażowa w komplecie

Kanlux GORDO LED14 is an overrun luminaire with an integrated LED light source for embedding into the ground. It is manufactured of best quality materials owing to which can resist pressure up to 2 tons.

Junction box included

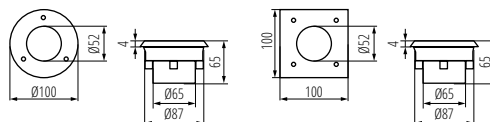

GORDO LED14 SMD-0

GORDO LED14 SMD-L

MORO DL

OPRAWA NAJAZDOWA ► IN-GROUND LIGHTING FITTING



MORO DL-35



MORO DL-35 | 04870 | 5905339048707 | max 35 | PAR16 | GU10 | stal nierdzewna | stainless steel

[V] 220-240 AC	[Hz] 50/60	PAR16	Light bulb icon	Grounding symbol	IP 67	0,5m	House icon	Temperature icon -20+35	Downward arrow icon	[kN] 20
IK 08	Stack of boxes icon	Dimensions icon 0,75+1,5	Light bulb icon	CE	EAC					

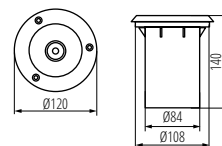

MORO DL-35

ROGER DL

OPRAWA DOGRUNTOWA ► IN-GROUND FIXTURE



ROGER DL-LED12

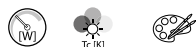

ROGER DL-LED12 | 07280 | 5905339072801 | 1 | 6000-6500 | szary | grey
ROGER DL-2LED6 | 07281 | 5905339072818 | 1 | 6000-6500 | szary | grey

[V] 220-240 AC	[Hz] 50/60	[h] 20000	Light bulb icon	Grounding symbol	IP 66	0,1m	House icon	Temperature icon -20+35	Light bulb icon	IK 09	Dimensions icon 0,3	Dimensions icon 0,75	CE	EAC		
-------------------	---------------	--------------	-----------------	------------------	----------	------	------------	----------------------------	-----------------	----------	------------------------	-------------------------	----	-----	--	--



ROGER DL-2LED6



Kanlux ROGER DL to oprawa dogruntowa z wbudowanym modulem LED. Specyficzny kształt klosza rozprowadza światło równomiernie, co przekłada się na wyjątkowy efekt świetlny. Oprawa cechuje się wysokim stopniem szczelności IP66 i odpornością na uszkodzenia mechaniczne IK09.

puszka montażowa w komplecie
Materiał obudowy: stal
Materiał szyby ochronnej: tworzywo sztuczne
Materiał panelu/ramki: stop aluminium

Kanlux ROGER DL is a ground-recessed luminaire with a built-in LED module. The specific shape of the shade distributes light evenly, which produces a unique light effect. The luminaire has a very high rating of tightness (IP66) and resistance to mechanical damage (IK09).

Junction box included
Enclosure material: steel
Protective glass material: plastic
Panel/frame material: aluminum alloy

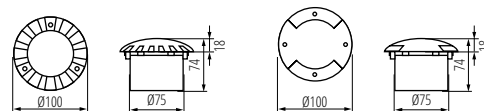

ROGER DL-LED12

ROGER DL-2LED6

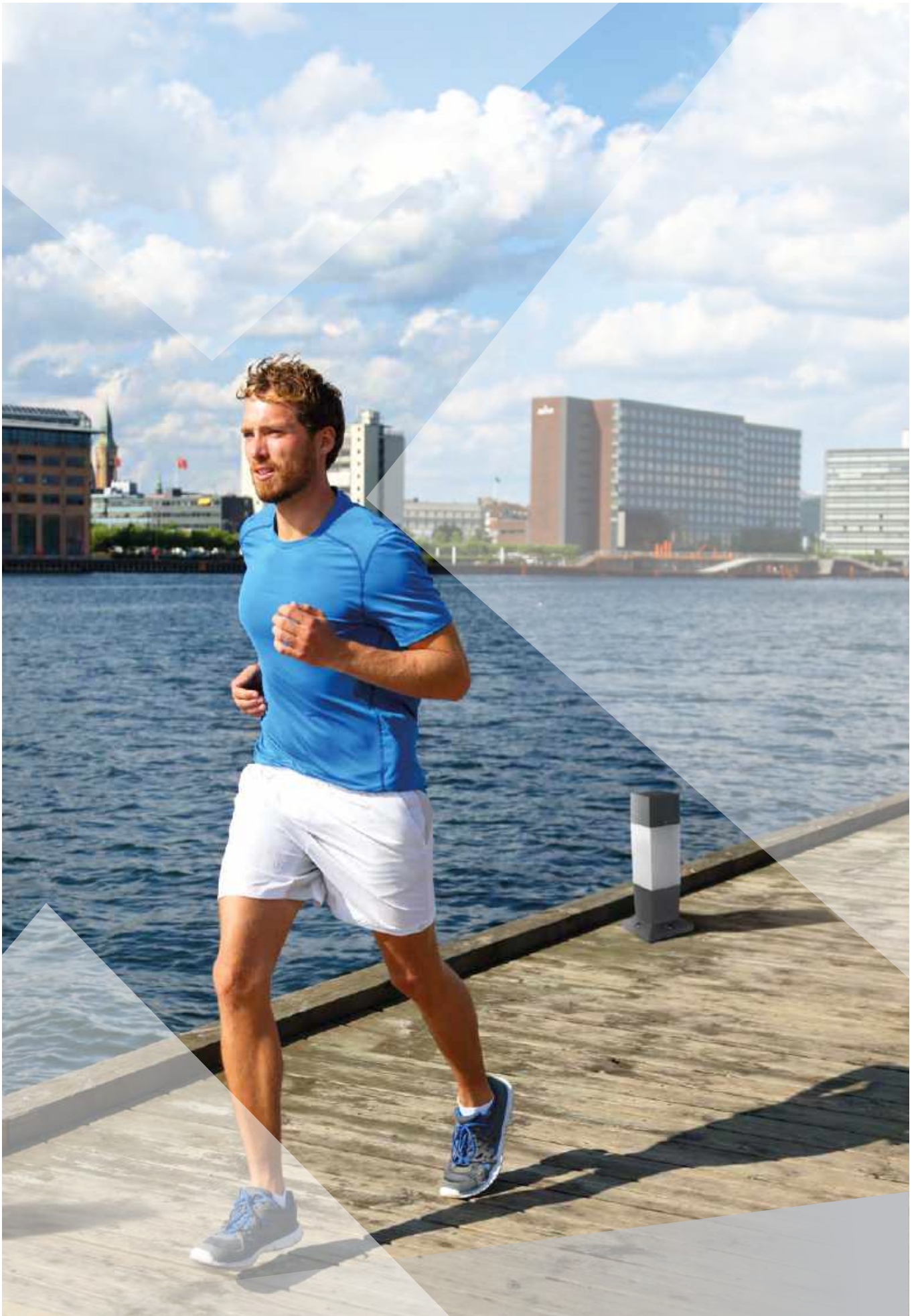

INVO OP

OPRAWA ARCHITEKTONICZNA Z WYMIENNYM ŹRÓDŁEM ŚWIATŁA ► ARCHITECTURAL LIGHTING WITH REPLACEABLE SOURCE OF LIGHT



INVO OP 77-L-GR



INVO OP EL-53-L-GR



INVO OP 47-L-GR



INVO OP 107-L-GR

IP 54
XXL size
Light bulb icon



Kanlux INVO OP to seria zewnętrznych opraw architektonicznych. Cała rodzina składa się z słupków oraz oprawy elewacyjnej. W oprawach Kanlux INVO zastosujesz ulubioną barwę światła, ponieważ jest ona przystosowana do wymiennych źródeł o trzonku E27.

Mleczny klosz

Materiał obudowy: tworzywo sztuczne

Materiał klosza: tworzywo sztuczne

Kanlux INVO OP is a series of external architectural luminaires. The whole family is composed of posts and façade luminaires.

You can use your favourite light colour in Kanlux INVO luminaires since it is adapted for replaceable sources with a E27 cap.

Milky lampshade

Enclosure material: plastic

Lampshade material: plastic



INVO OP EL-53-L-GR	29170	5905339291707	max 20	GLS/CFL/LED	E27	grafitowy graphite	do nadbudowania na ścianie wall mounted
INVO OP 47-L-GR	29171	5905339291714	max 20	GLS/CFL/LED	E27	grafitowy graphite	do nadbudowania na podłożu surface mounted
INVO OP 77-L-GR	29172	5905339291721	max 20	GLS/CFL/LED	E27	grafitowy graphite	do nadbudowania na podłożu surface mounted
INVO OP 107-L-GR	29173	5905339291738	max 20	GLS/CFL/LED	E27	grafitowy graphite	do nadbudowania na podłożu surface mounted

[V] 220-240 AC	[Hz] 50/60	Light bulb icon	IP 54	House icon	Kanlux E
Temperature icon -20+35	Light bulb icon	Dimensions icon 0,75+1,5	Dimensions icon 0,5m	CE	EAC

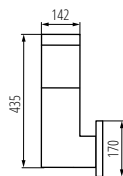

INVO OP EL-53

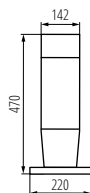

INVO OP 47

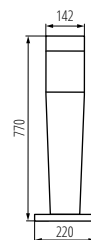

INVO OP 77

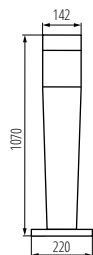

INVO OP 107

INVO TR

OPRAWA ARCHITEKTONICZNA Z WYMIANNYM ŹRÓDŁEM ŚWIATŁA ► ARCHITECTURAL LIGHTING WITH REPLACEABLE SOURCE OF LIGHT



INVO TR 77-O-GR



INVO TR EL-53-O-GR



INVO TR 47-O-GR



INVO TR 107-O-GR

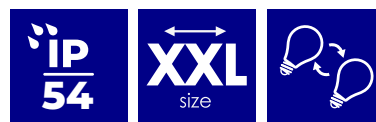

Kanlux INVO TR to seria opraw architektonicznych z wymiennym źródłem światła GU10. Zewnętrzne słupki i oprawa elewacyjna bardzo efektywnie rozpraszają światło nie tylko w ogrodzie, ale również rozświetlą, alejki, ścieżki czy trasy spacerowe. Każda oprawa posiada miejsce na 3 źródła światła.

Transparentny klosz

Materiał obudowy: tworzywo sztuczne

Materiał klosza: tworzywo sztuczne

Kanlux INVO TR is a series of architectural luminaires with a replaceable GU10 light source. External posts and is a series of external architectural luminaires offer a very effective distribution of light in the garden and lighting of alleys, paths or walking routes. Each luminaire has a space for 3 light sources.

Transparent lampshade

Enclosure material: plastic

Lampshade material: plastic



INVO TR EL-53-O-GR	29174	5905339291745	3 x max 3,5	PAR16	GU10	grafitowy graphite	do nadbudowania na ścianie wall mounted
INVO TR 47-O-GR	29175	5905339291752	3 x max 3,5	PAR16	GU10	grafitowy graphite	do nadbudowania na podłożu surface mounted
INVO TR 77-O-GR	29176	5905339291769	3 x max 3,5	PAR16	GU10	grafitowy graphite	do nadbudowania na podłożu surface mounted
INVO TR 107-O-GR	29177	5905339291776	3 x max 3,5	PAR16	GU10	grafitowy graphite	do nadbudowania na podłożu surface mounted

[V] 220-240 AC	[Hz] 50/60				IP 54	
 -20+35		 0,75+2,5	 0,5m	CE	ERAC	

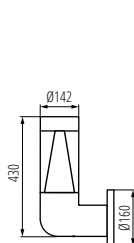

INVO TR EL-53

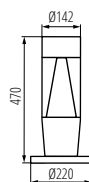

INVO TR 47

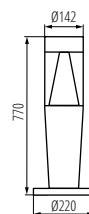

INVO TR 77

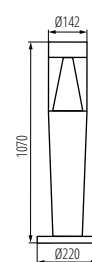

INVO TR 107

SEVIA LED

OPRAWA OGRODOWA LED ► LED GARDEN LIGHTING FIXTURE



SEVIA LED 26-SE



SEVIA LED 26



SEVIA LED 50



SEVIA LED 80



Kanlux SEVIA to nowatorski design i czarny uniwersalny kolor, który sprawdzi się w każdej przestrzeni. Nietypowe oprawy wykonane są ze stopu aluminium i szkła.

SEVIA LED 26-SE wyposażona w czujnik ruchu/ możliwość regulacji czasu świecenia od 5s do 4 min/ maksymalny zasięg wykrywania ruchu do 3,5 m/ horyzontalny kąt wykrywania ruchu 120°/ możliwość ustawienia poziomu natężenia oświetlenia otoczenia, przy którym urządzenie pracuje w zakresie 3...2000lx

Materiał obudowy: stop aluminium
Materiał szyby ochronnej: szkło

Kanlux SEVIA is an innovative design and black universal colour that will fit any space. The unusual frames are made of aluminum alloy and glass.

SEVIA LED 26-SE equipped with a motion sensor/adjustable on time from 5 s to 4 min/ maximum motion detection range up to 3.5 m/horizontal angle of motion detection 120°/ adjustable area illumination intensity at which the device operates at 3...2000lx range.

Enclosure material: aluminum alloy
Protective glass material: glass

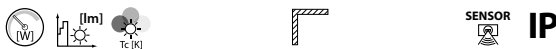

SEVIA LED 26	23550	5905339235503	9	600	4000	do nadbudowania na ścianie wall mounted	54
SEVIA LED 26-SE	23551	5905339235510	9,5	600	4000	do nadbudowania na ścianie wall mounted	PIR 44
SEVIA LED 50	23552	5905339235527	9	600	4000	do nadbudowania na podłożu surface mounted	54
SEVIA LED 80	23554	5905339235541	9	600	4000	do nadbudowania na podłożu surface mounted	54

[V] 220-240 AC	[Hz] 50/60		 ≥15000	 30000
 ellipse ≤ 6m Możliwość	 Ra ≥80			
	 [°C] -20÷35		 0,5-2,5	 0,2m
CE	EAR	 		

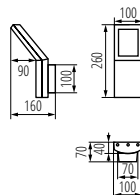

SEVIA LED 26; 26-SE

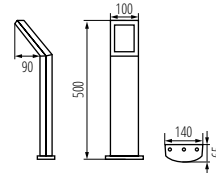

SEVIA LED 50

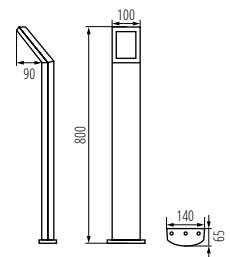

SEVIA LED 80

DROMI LED



OPRAWA OGRODOWA LED ► LED GARDEN LIGHTING FIXTURE



DROMI LED EL-1 7W-GR



DROMI LED EL-2 13W-GR



DROMI LED 50 7W-GR



DROMI LED 80 7W-GR

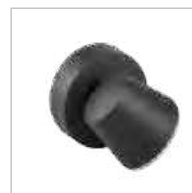

Kanlux DROMI LED to seria opraw ogrodowych ze zintegrowanym źródłem światła. Lampy te charakteryzują się możliwością zmiany kierunku świecenia, klasą szczelności IP54 i neutralną temperaturą barwową światła 4000K. Oprawy są w kolorze ciemnografitowym, a gdy dodamy do tego niebanalną stylistykę to możemy być pewni, że sprawdzą się one w każdym ogrodzie.

Materiał obudowy: stop aluminium
Materiał klosza: tworzywo sztuczne

Kanlux DROMI LED is a series of garden fittings with an integrated source of light. These lamps are characterized by a possibility of changing the direction of light, IP54 tightness class and neutral colour temperature of light 4000K. These fittings are in dark graphite colour and when you add original stylistics to this then you can be sure that they will prove themselves in each garden.

Enclosure material: aluminum alloy
Lampshade material: plastic



DROMI LED EL-1 7W-GR	32530	5905339325303	7,5	350	4000	do nadbudowania na ścianie wall mounted	grafitowy graphite
DROMI LED EL-2 13W-GR	32531	5905339325310	13,5	650	4000	do nadbudowania na ścianie wall mounted	grafitowy graphite
DROMI LED 50 7W-GR	32532	5905339325327	7,5	350	4000	do nadbudowania na podłożu surface mounted	grafitowy graphite
DROMI LED 80 7W-GR	32533	5905339325334	7,5	350	4000	do nadbudowania na podłożu surface mounted	grafitowy graphite

[V] 220-240 AC	[Hz] 50	⚡ ≥25000	⌚ 30000	☀️ ≤6x MacAdam	Ra ≥80	SMD	⚡ IP 54	🏠
🌡️ -15+40	↻ 300	📦 1,5-2,5	🔌 0,5m	CE	ERL	Kanlux		

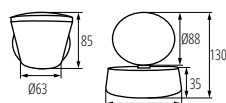

DROMI LED EL-1 7W-GR

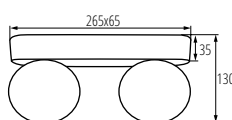

DROMI LED EL-2 13W-GR

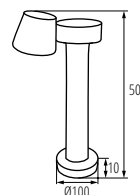

DROMI LED 50 7W-GR

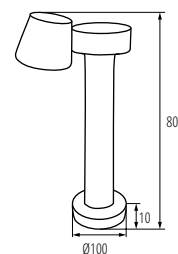

DROMI LED 80 7W-GR

Kanlux NOVIA

OPRAWA OGRODOWA Z WYMIENNYM ŹRÓDŁEM ŚWIATEŁA ►
GARDEN LIGHT FITTING WITH REPLACEABLE LIGHT SOURCE



NOVIA EL 220 U/D



NOVIA EL 120 D



NOVIA 120 D



Oprawy Kanlux NOVIA znajdują swoich zwolenników wśród osób szukających oświetlenia zarówno ogólnego jak i akcentowego w swoim ogrodzie. Oprawy Kanlux NOVIA posiadają charakterystyczne „okienko” w części frontowej, które po zaświeceniu staje się dodatkowym akcentem świetlnym.

Materiał obudowy: stop aluminium

Materiał szyby ochronnej: szkło

Kanlux NOVIA luminaires will find their enthusiasts among people looking for both general and accent lighting in their gardens. Kanlux NOVIA luminaires are equipped with the characteristic “window” in the front part, which becomes an additional light accent when turned on.

Enclosure material: aluminum alloy

Protective glass material: glass



NOVIA 120 D	25661	5905339256614	max 20	PAR16	GU10	do nadbudowania na podłożu surface mounted	czarny black	dół down
NOVIA EL 120 D	25662	5905339256621	max 20	PAR16	GU10	do nadbudowania na ścianie wall mounted	czarny black	dół down
NOVIA EL 220 U/D	25663	5905339256638	2 x max 20	PAR16	GU10	do nadbudowania na ścianie wall mounted	czarny black	góra i dół up and down

[V] 220-240 AC	[Hz] 50/60	PAR16	Light bulb icon	Grounding symbol	IP 44	House icon
Temperature icon -20+35	Light bulb icon	Beam angle icon 0,5+2,5	Light bulb icon	Distance icon 0,5m	CE	EAC

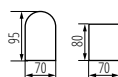

NOVIA EL 120 D

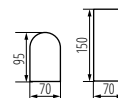

NOVIA EL 220 U/D

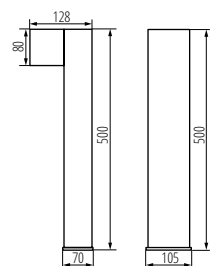

NOVIA 120 D

Kanlux GORI

OPRAWA OGRODOWA Z WYMIENNYM ŹRÓDŁEM ŚWIATŁA ►
GARDEN LIGHT FITTING WITH REPLACEABLE LIGHT SOURCE



GORI EL 235 D



GORI EL 135 D



GORI 50



GORI 80



GORI EL 135 D	29000	5905339290007	max 35	GU10	PAR16	antracyt anthracite	góra lub dół
GORI EL 235 D	29001	5905339290014	2 x max 35	GU10	PAR16	antracyt anthracite	góra i dół up and down
GORI 50	29002	5905339290021	max 35	GU10	PAR16	antracyt anthracite	dół down
GORI 80	29003	5905339290038	max 35	GU10	PAR16	antracyt anthracite	dół down



Oprawy ogrodowe Kanlux GORI to kompletna seria, która składa się z kinkietów i słupków. Ich kwadratowy, surowy kształt jest odpowiedzią na obecne trendy. Wszystkie oprawy Kanlux GORI posiadają wymienne źródła światła, co daje możliwość dowolnego wyboru barwy i natężenia przydomowego światła.

Materiał obudowy: stop aluminium
Materiał szyby ochronnej: szkło hartowane

Kanlux GORI garden fixtures are a complete range, they consist of wall lamps and posts. Their square, austere shape is a direct response to market trends. All Kanlux GORI fixtures are equipped with replaceable light sources which give the possibility of a free choice of light colour and intensity around the house.

Enclosure material: aluminum alloy
Protective glass material: Tempered glass

[V] 220-240 AC	[Hz] 50/60	PAR16	IP 44	CE	EAC	Kanlux
°C -20+35	[mm] 1+2,5	0,5m				A A A B C D E

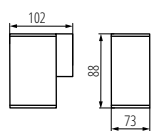

GORI EL 135

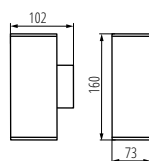

GORI EL 235

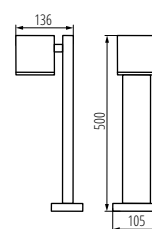

GORI 50

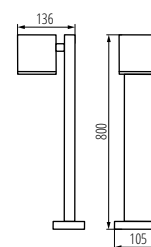

GORI 80

Kanlux VADRA

OPRAWA OGRODOWA Z WYMIENNYM ŹRÓDŁEM ŚWIATŁA ► GARDEN LIGHT FITTING WITH REPLACEABLE LIGHT SOURCE



VADRA 21L-UP SE



VADRA 16L-UP



VADRA 50



VADRA 80

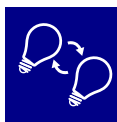

Zewnętrzne oprawy oświetleniowe Kanlux VADRA przeznaczone są do montażu ściennego (kinkiety) lub na podłożu stałym (słupki). Kanlux VADRA posiadają wymienne źródła światła, co daje możliwość dowolnego wyboru barwy i natężenia przydomowego światła.

Maksymalna wysokość źródła światła 110mm
VADRA 21L-UP SE - oprawa z czujnikiem ruchu PIR

Materiał obudowy: stop aluminium
Materiał klosza: tworzywo sztuczne

External Kanlux VADRA fixtures are designed for wall mounting (wall lamps) or on solid ground (posts). Kanlux VADRA are equipped with replaceable light sources which give the possibility of a free choice of light colour and intensity around the house.

Maximum light-source height 110mm

VADRA 21L-UP SE fixture with PIR motion sensor

Enclosure material: aluminum alloy
Lampshade material: plastic



VADRA 16L-UP	29010	5905339290106	max 11	E27	GLS/CFL/LED	antracyt anthracite
VADRA 21L-UP SE	29011	5905339290113	max 11	E27	GLS/CFL/LED	antracyt anthracite
VADRA 50	29012	5905339290120	max 11	E27	GLS/CFL/LED	antracyt anthracite
VADRA 80	29013	5905339290137	max 11	E27	GLS/CFL/LED	antracyt anthracite

[V] 220-240 AC	[Hz] 50/60	Light bulb icon	Grounding symbol	IP 44	House icon	Temperature range -20+35	Light bulb icon
1,5+2,5	Light bulb icon	Light bulb icon	CE	ERAC	Kanlux logo	Light bulb icon	Light bulb icon

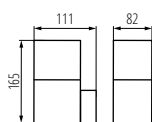

VADRA 16L

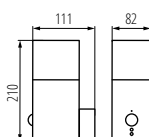

VADRA 21L

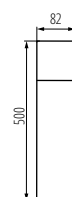

VADRA 50

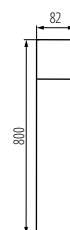

VADRA 80

SORTA

OPRAWA OGRODOWA Z WYMIENNYM ŹRÓDŁEM ŚWIATŁA ► GARDEN LIGHT FITTING WITH REPLACEABLE LIGHT SOURCE



SORTA 16L-UP-SE



Kanlux SORTA to oprawy ogrodowe, które cechuje możliwość wymiany źródła światła, co pozwala na dostosowanie barwy i mocy oświetlenia do indywidualnych potrzeb. Oprawy zbudowane są ze szkła i aluminium, a ich czarno-biała kolorystyka wpisze się niemal w każdą scenię. Dodatkowym atutem jest opalizowany klosz, który równomiernie rozprasza światło.

max. szerokość źródła 55mm
 SORTA 16L-UP-SE wyposażona w czujnik ruchu / możliwość regulacji czasu świecenia od 5s do 8 min / maksymalny zasięg wykrywania ruchu do 3m / horyzontalny kąt wykrywania ruchu 110°

Materiał obudowy: stop aluminium
 Materiał klosza: PC

Kanlux SORTA are garden luminaires characterised by the option of changing the light source, which allows for adjusting the colour and power of lighting to individual needs. The luminaires are made of glass and aluminum. Their black and white colouring matches almost every scenery. The opal lampshade that evenly disperses light is its additional asset.

max. width of source 55mm
 SORTA 16L-UP-SE equipped with a motion sensor / possibility of adjusting the time of lighting from 5s to 8 min / maximum motion detection range up to 3m / horizontal angle of motion detection 110°

Enclosure material: aluminum alloy
 Lampshade material: PC



SORTA 16L-UP



SORTA 30I-UP



SORTA 50



SORTA 80



SORTA 16L-UP	25680	5905339256805	max 20	GLS/CFL/LED	E27	do nadbudowania na ścianie wall mounted	czarny black
SORTA 16L-UP-SE	25681	5905339256812	max 20	GLS/CFL/LED	E27	do nadbudowania na ścianie wall mounted	czarny black
SORTA 30I-UP	25682	5905339256829	max 20	GLS/CFL/LED	E27	do nadbudowania na ścianie wall mounted	czarny black
SORTA 50	25683	5905339256836	max 20	GLS/CFL/LED	E27	do nadbudowania na podłożu surface mounted	czarny black
SORTA 80	25684	5905339256843	max 20	GLS/CFL/LED	E27	do nadbudowania na podłożu surface mounted	czarny black

[V] 220-240 AC	[Hz] 50/60			IP 44			-20+35
	0,5+2,5	0,2m	CE	EAC	 Kanlux		

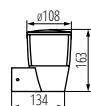

SORTA 16L-UP

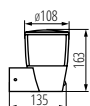

SORTA 16L-UP-SE

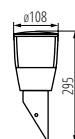

SORTA 30I-UP

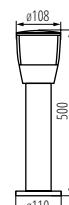

SORTA 50



SORTA 80

OPRAWA OGRODOWA Z WYMIENNYM ŹRÓDŁEM ŚWIATŁA ► GARDEN LIGHT FITTING WITH REPLACEABLE LIGHT SOURCE



RILA 23L-UP

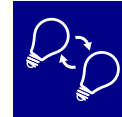

Kanlux RILA to oprawy ogrodowe z wymiennym źródłem światła o trzonku E27, które ze względu na swój oryginalny design pełnią również funkcję dekoracyjną. Dzięki zastosowaniu wysokiej jakości materiałów w postaci stopu aluminium będą nam służyć przez wiele lat.

Materiał obudowy: stop aluminium

Materiał szyby ochronnej: tworzywo sztuczne



Kanlux RILA are garden luminaires with replaceable light source with E27 screw that also have decorative function due to their original design. Owing to the use of high quality materials - an aluminum alloy, we can use them for long years.



Enclosure material: aluminum alloy

Protective glass material: plastic



RILA 23L-DOWN

RILA 81-PEND

RILA 30

RILA 100



RILA 23L-UP	23580	5905339235800	max 60	GLS/CFL/LED	E27	do nadbudowania na ścianie wall mounted	grafitowy graphite
RILA 23L-DOWN	23581	5905339235817	max 60	GLS/CFL/LED	E27	do nadbudowania na ścianie wall mounted	grafitowy graphite
RILA 81-PEND	23582	5905339235824	max 60	GLS/CFL/LED	E27	do nadbudowania na suficie ceiling mounted	grafitowy graphite
RILA 30	23583	5905339235831	max 60	GLS/CFL/LED	E27	do nadbudowania na ścianie wall mounted	grafitowy graphite
RILA 100	23584	5905339235848	max 60	GLS/CFL/LED	E27	do nadbudowania na podłożu surface mounted	grafitowy graphite

[V] 220-240 AC	[Hz] 50/60			IP 44		 -20÷35
	0,5÷2,5		0,2m	CE	ERC	

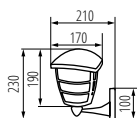

RILA 23L-UP

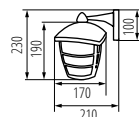

RILA 23L-DOWN

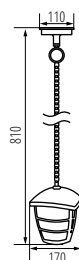

RILA 81-PEND

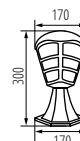

RILA 30

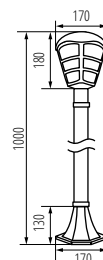

RILA 100

Kanlux GRIBLO LED

OPRAWA OGRODOWA LED ► LED GARDEN LIGHTING FIXTURE



GRIBLO LED SMD-NW

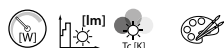

GRIBLO LED SMD-NW | **18131** | 5905339181312 | 4 | 170 | 5000 | szary | grey

[V] 220-240 AC	[Hz] 50/60	[lm] ≥15000	[°] 35	[h] 30000	[lm] ≤ for MacAdam	Ra ≥80	SMD	IP 65	⚡
°C -15÷35	↺	↺ ^(°) 180	↺	[mm] 1	[mm] 1	⚡ 0,1m	W 43	CE	ERL



Kanlux GRIBLO LED została wyposażona w diody LED SMD charakteryzujące się wysoką energooszczędnością oraz trwałością szacowaną na 30.000 h. Kanlux GRIBLO LED to oprawa dogruntowa o wysokim stopniu szczelności (IP65).

Materiał obudowy: stop aluminium

Materiał szyby ochronnej: szkło

Kanlux GRIBLO LED is equipped with SMD LEDs characterised by high energy efficiency and durability estimated at 30,000 hrs. Kanlux GRIBLO LED is a ground recessed luminaire with a high level of tightness (IP65).

Enclosure material: aluminum alloy

Protective glass material: glass

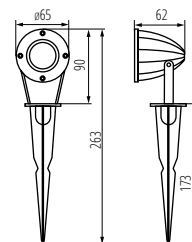

GRIBLO LED SMD-NW

Kanlux AKVEN LED

OPRAWA OGRODOWA Z WYMIENNYM ŹRÓDŁEM ŚWIATŁA ► GARDEN LIGHT FITTING WITH REPLACEABLE LIGHT SOURCE



AKVEN LED



AKVEN LED | **25720** | 5905339257208 | max 35 | PAR16 | Gx5,3 | zielony | green

[V] 12 AC; 12 DC	[Hz] 50/60	[lm] 370	[°] 120	[h] 25000	[lm] ≤ for MacAdam	Ra ≥80	Tc (K) 3000	IP 68	⚡
°C -20÷35	↺	↺ ^(°) 180	↺	[mm] 1-1,5	[mm] 0,5m	CE	ERL	Kanlux	A A A B C D E



Wodoszczelna oprawa Kanlux AKVEN LED to idealne rozwiązanie do oświetlenia oczek wodnych. Wyposażona jest w wymienne źródło światła LED i przystosowana do długotrwałego zanurzenia w wodzie na głębokość do 3 metrów.

Materiał obudowy: stop aluminium

Materiał klosza: szkło

Materiał szyby ochronnej: szkło

Waterproof Kanlux AKVEN LED luminaire is a perfect solution for lighting ponds. It is equipped with a replaceable LED light source and adapted to long-term immersion in water, even 3 metres deep.

Enclosure material: aluminum alloy

Lampshade material: glass

Protective glass material: glass

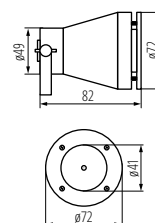

AKVEN LED

IDAVA

OPRAWA OGRODOWA Z WYMIENNYM ŹRÓDŁEM ŚWIATŁA ► GARDEN LIGHT FITTING WITH REPLACEABLE LIGHT SOURCE



IDAVA 25



IDAVA 25



IDAVA 35



IDAVA 47

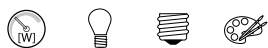

IDAVA 25	23510	5905339235107	25	GLS/CFL/LED	E27	biały white
IDAVA 35	23511	5905339235114	40	GLS/CFL/LED	E27	biały white
IDAVA 47	23512	5905339235121	40	GLS/CFL/LED	E27	biały white

[V] 220-240 AC	[Hz] 50/60			IP 44			
	 3	 1	 0,2m				

AKCESORIA ► ACCESSORIES

GL-IDAVA PS LS 25	23513	5905339235138	Klosz do oprawy IDAVA 25 Shade for IDAVA 25 fitting
GL-IDAVA PS LS 35	23514	5905339235145	Klosz do oprawy IDAVA 35 Shade for IDAVA 35 fitting
GL-IDAVA PS LS 47	23515	5905339235152	Klosz do oprawy IDAVA 47 Shade for IDAVA 47 fitting
IDAVA SPIKE	23516	5905339235169	Podstawa do oprawy IDAVA Base for IDAVA fitting



Niebanalna, a jednocześnie prosta w swej formie oprawa dogruntowa Kanlux IDAVA to idealny sposób na stworzenie jasnych przestrzeni w ogrodzie. Oprawy te cechuje wysoki stopień szczelności, a jej konstrukcja oraz tworzywo sztuczne, z którego wykonany jest klosz, dodatkowo chroni źródło światła przed wpływem czynników zewnętrznych.

w komplecie przewód 3m

Materiał obudowy: tworzywo sztuczne

Materiał klosza: tworzywo sztuczne

Extraordinary yet simple in its form - recessed ground lamp Kanlux IDAVA is perfect for creating bright spaces in the garden. The luminaires are characterised by a high degree of tightness, and its construction and plastic of which the shade is made, additionally protects the light source from the influence of external factors.

a cable of 3m in a set

Enclosure material: plastic

Lampshade material: plastic

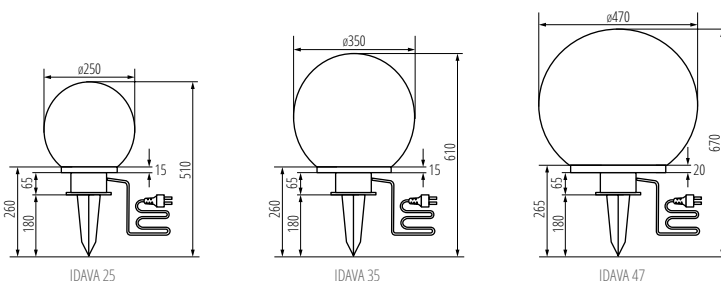

STONO

OPRAWA OGRODOWA Z WYMIENNYM ŹRÓDŁEM ŚWIATEŁA ►
GARDEN LIGHT FITTING WITH REPLACEABLE LIGHT SOURCE



STONO 50

NEW



STONO IS 63



STONO 20 N



STONO 30



STONO 40



STONO 20 N	24654	5905339246547	max 15	GLS/CFL/LED	E27	granit Granite
STONO 30	24651	5905339246516	max 25	GLS/CFL/LED	E27	granit Granite
STONO 40	24652	5905339246523	max 25	GLS/CFL/LED	E27	granit Granite
STONO 50	24653	5905339246530	max 25	GLS/CFL/LED	E27	granit Granite
STONO IS 63	24656	5905339246561	2 x max 25	GLS/CFL/LED	E27	granit Granite

[V] 220-240 AC	[Hz] 50/60	Light bulb icon	Socket icon	IP 65	House icon	Temperature icon -20°-35°	Down arrow icon
3	1	0,2m	CE	ERL	Kanlux logo and A-E grades		

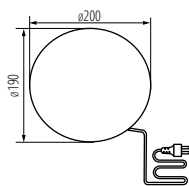

STONO 20 N

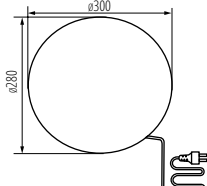

STONO 30

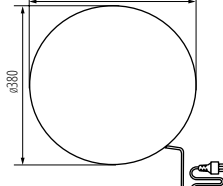

STONO 40

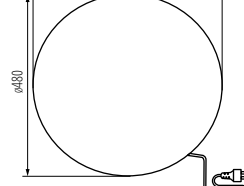

STONO 50

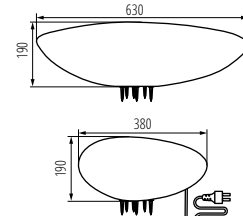

STONO IS 63

MODERN design



IP 65



Oprawy ogrodowe Kanlux STONO to imitujące kamienie świetlne kule o średnicach od 20 do 50 cm. Idealnie wkomponują się w miejsca skalniaków czy w otoczenie krzewów. Każda z nich wyposażona jest w podstawę pozwalającą osadzić oprawę w gruncie.

Materiał obudowy: ABS
Materiał klosza: PE

Garden luminaires Kanlux STONO are light balls imitating stones, available with diameters from 20 to 50 cm. They blend perfectly in rockeries or bushes. Each of them is equipped with a base allowing for fitting the luminaire in the ground.

Enclosure material: ABS
Lampshade material: PE

Kanlux SOLCA L

OPRAWA SOLARNA LED ► SOLAR LED LIGHT FITTING

NEW



SOLCA L PV EL-B



SOLCA L PV 50-B



SOLCA L PV 50 SPI-B



Kanlux SOLCA L to ogrodowe oprawy solarne o kwadratowych kloszach, które są niezależne od instalacji elektrycznej. Dzięki temu mamy większą dowolność w ich usytuowaniu. Kolejne przewagi opraw Kanlux SOLCA L to: szybka i łatwa instalacja i oszczędność energii elektrycznej. Lampy Kanlux SOLCA L mogą działać w 3 różnych trybach natężenia oświetlenia, a ponadto wyposażone są w czujnik ruchu.

Materiał obudowy: stal

Materiał klosza: tworzywo sztuczne

Kanlux SOLCA L are garden solar fittings with square shades which are independent of an electric installation. Thanks to this, they can be situated more freely. Quick and simple installation and power saving capacity are other advantages of Kanlux SOLCA L fittings. Kanlux SOLCA L lamps may work in 3 different modes and, moreover, they are equipped with a motion detector.

Enclosure material: steel

Lampshade material: plastic



SOLCAL PV EL-B	25774	5905339257741	max 5	max 500	4000	do nadbudowania na ścianie wall mounted	czarny black
SOLCAL PV 50-B	25775	5905339257758	max 5	max 500	4000	do nadbudowania na podłożu surface mounted	czarny black
SOLCAL PV 50 SPI-B	25776	5905339257765	max 5	max 500	4000	dogruntowa In the ground	czarny black

[V] 3,7 DC		 ≥6000	 12000	 ≤60° Nachdam		
		 -20+35	 0,2m			

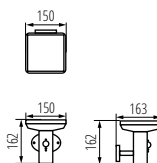
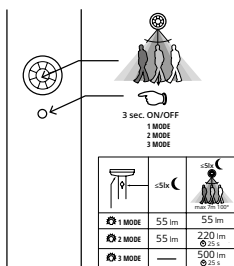

SOLCA L PV EL-B

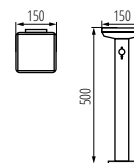

SOLCA L PV 50-B

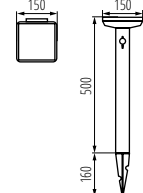

SOLCA L PV 50 SPI-B

Kanlux SOLCA O

OPRAWA SOLARNA LED ► SOLAR LED LIGHT FITTING

NEW



SOLCA O PV EL-B



SOLCA O PV 50-B



SOLCA O PV 50 SPI-B



Kanlux SOLCA O to ogrodowe oprawy solarne o okrągłych kloszach, które są niezależne od instalacji elektrycznej. Dzięki temu mamy większą dowolność w ich usytuowaniu. Kolejnymi przewagami opraw Kanlux SOLCA O są: szybka i łatwa instalacja i oszczędność energii elektrycznej. Lampy Kanlux SOLCA O mogą działać w 3 różnych trybach świecenia, a ponadto wyposażone są w czujnik ruchu.

Materiał obudowy: stal

Materiał klosza: tworzywo sztuczne

Kanlux SOLCA O are garden solar fittings with round shades which are independent of an electric installation. Thanks to this, they can be situated more freely. Quick and simple installation and power saving capacity are other advantages of Kanlux SOLCA O fittings. Kanlux SOLCA O lamps may work in 3 different modes and, moreover, they are equipped with a motion detector.

Enclosure material: steel

Lampshade material: plastic



Model	Code	Part No.	Max H	Max R	Max L	Installation	Color
SOLCA O PV EL-B	25771	5905339257710	max 5	max 500	4000	do nadbudowania na ścianie wall mounted	czarny black
SOLCA O PV 50-B	25772	5905339257727	max 5	max 500	4000	do nadbudowania na podłożu surface mounted	czarny black
SOLCA O PV 50 SPI-B	25773	5905339257734	max 5	max 500	4000	dogruntowa In the ground	czarny black

[VI]	3,7 DC	≥6000	12000	ellipso s/6xMax/dam	SMD	
III	IP 44		-20÷35	0,2m	CE	EAC

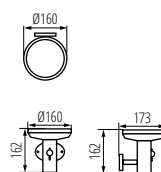
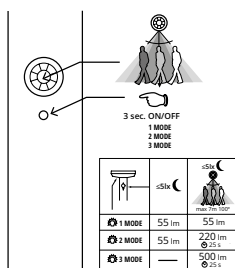

SOLCA O PV EL-B

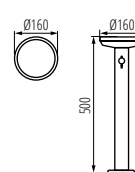

SOLCA O PV 50-B

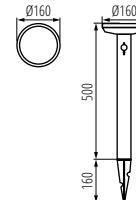

SOLCA O PV 50 SPI-B

ACORD ATL1

PROJEKTOR NA SZYNOPRZEWÓD ► RAIL-MOUNTED PROJECTOR

NEW



ATL1 30W



ATL1 18W

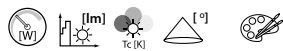

ATL1 18W-930-S6-W	33130	5905339331304	18	1700	3000	60	biały white
ATL1 18W-930-S6-B	33131	5905339331311	18	1700	3000	60	czarny black
ATL1 18W-940-S6-W	33132	5905339331328	18	1800	4000	60	biały white
ATL1 18W-940-S6-B	33133	5905339331335	18	1800	4000	60	czarny black
ATL1 30W-930-S6-W	33134	5905339331342	30	2850	3000	60	biały white
ATL1 30W-930-S6-B	33135	5905339331359	30	2850	3000	60	czarny black
ATL1 30W-940-S6-W	33136	5905339331366	30	3000	4000	60	biały white
ATL1 30W-940-S6-B	33137	5905339331373	30	3000	4000	60	czarny black

[V] 220-240 AC	[Hz] 50	[lm] ≥30000	[h] 50000	[Ra] ≥90	[COB]
[IP] IP20	[°C] 5+25	[°]	[°]	[°]	[°]
[90]	[0,5m]	[CE]	[EAC]	[Kanlux]	[X]



Kanlux ACORD ATL 1 to zintegrowane oprawy oświetleniowe do zamontowania na szynoprzewody trójjobwodowe. To lampy, które możemy dostosować do naszych indywidualnych potrzeb. Do wyboru mamy kolor biały lub czarny, dwie moce (18W i 30W), barwę światła i kąt świecenia (standardowy to 60°, jednak możemy samodzielnie wymienić reflektor i zmienić kąt na 15° lub 36°) zależnie od tego czy chcemy oświetlić powierzchnię, czy konkretny detal. Kanlux ACORD ATL 1 to 50 000 godzin trwałości i 5 lat gwarancji. Markowe kluczowe komponenty (LED COB i zasilacz), wysoki poziom oddawanie realnych barw (CRI>90) i wyeliminowanie efektu olśnienia (UGR <19) to kolejne zalety tych wyjątkowych opraw.

5 lat Gwarancji na warunkach oświadczenia gwarancyjnego, dostępnego na stronie internetowej

Materiał obudowy: stop aluminium

Materiał szyby ochronnej: tworzywo sztuczne

Kanlux ACORD ATL 1 are integrated lighting fixtures to be mounted on three-phase track. These are lamps that can be adapted to our individual needs. We can choose white or black, two powers (18W and 30W), light color and lighting angle (standard is 60°, but we can replace the reflector and change the angle to 15° or 36°) depending on whether we want to illuminate the surface or a specific detail. Kanlux ACORD ATL 1 stands for 50 000 hours of durability and a 5-year warranty. Branded key components (LED COB and power supply), high level of real color rendering (CRI > 90) and elimination of glare (UGR < 19) are other advantages of these unique luminaires.

5 years Warranty under the terms of the warranty statement, available on our website

Enclosure material: aluminum alloy

Protective glass material: plastic

ACORD ATLI

PROJEKTOR NA SZYNOPRZEWÓD ► RAIL-MOUNTED PROJECTOR



ATL1 18W



ATL1 18W



ATL1 30W



ATL1 30W

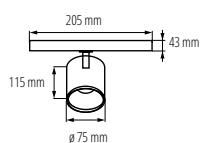

ATL1 18W

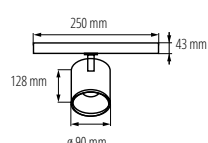

ATL1 30W

AKCESORIA ► ACCESSORIES

REF ATL1-18W-S15	33140	5905339331403	Reflektor do oprawy ATL 1, 18W, 15 stopni Reflector for the ATL 1 luminaire, 18 W, 15 degrees
REF ATL1-18W-S36	33141	5905339331410	Reflektor do oprawy ATL 1, 18W, 36 stopni Reflector for the ATL 1 luminaire, 18 W, 36 degrees
REF ATL1-30W-S15	33142	5905339331427	Reflektor do oprawy ATL 1, 30W, 15 stopni Reflector for the ATL 1 luminaire, 30 W, 15 degrees
REF ATL1-30W-S36	33143	5905339331434	Reflektor do oprawy ATL 1, 30W, 36 stopni Reflector for the ATL 1 luminaire, 30 W, 15 degrees



REF ATL1-18W-S15



REF ATL1-18W-S36



REF ATL1-30W-S15



REF ATL1-30W-S36



Kanlux

ACORD ATL2 GU10

PROJEKTOR NA SZYNOPRZEWÓD ► RAIL-MOUNTED PROJECTOR

NEW



ATL2 GU10-W



ATL2 GU10-W



ATL2 GU10-B



ATL2 GU10-W	33138	5905339331380	max 10	biały white
ATL2 GU10-B	33139	5905339331397	max 10	czarny black

[V]	[Hz]	[W]	[PAR]	[GU]	[IP]
220-240 AC	50	max 10	PAR16	GU10	20
House icon	°C icon 5+25	Hand icon	330°	100°	0,5m
CE	ERC				



Kanlux ACORD ATL 2 to oprawy oświetleniowe do zamontowania na szynoprzewody trójobwodowy. To lampy z wymiennym źródłem światła, które możemy dostosować do naszych indywidualnych potrzeb. Do wyboru mamy kolor oprawy: biały lub czarny, i źródło światła. Zależnie od naszych potrzeb możemy wybrać odpowiednią barwę, kąt świecenia i moc.

Materiał obudowy: stop aluminium

Kanlux ACORD ATL 2 are lighting fixtures to be mounted on three-phase track. These are lamps with a replaceable light source that can be adapted to our individual needs. We can choose the color of the fitting: white or black, and a light source. Depending on our needs, we can choose the right color, lighting angle and power. Kanlux ACORD ATL 1 luminaires have a 5-year warranty.

Enclosure material: aluminum alloy

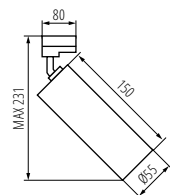

ATL2 GU10



	TEAR N TR 1M-W	33230	5905339332301	Element systemu szynowego, TEAR N TR 1M-W, szynoprzewód 3-obwodowy, biały, (33230) Track system component, TEAR N TR 1M-W, 3-circuit track, white, (33230)
	TEAR N TR 1M-B	33231	5905339332318	Element systemu szynowego, TEAR N TR 1M-B, szynoprzewód 3-obwodowy, czarny, (33231) Track system component, TEAR N TR 1M-B, 3-circuit track, black, (33231)
	TEAR N TR 2M-W	33232	5905339332325	Element systemu szynowego, TEAR N TR 2M-W, szynoprzewód 3-obwodowy, biały, (33232) Track system component, TEAR N TR 2M-W, 3-circuit track, white, (33232)
	TEAR N TR 2M-B	33233	5905339332332	Element systemu szynowego, TEAR N TR 2M-B, szynoprzewód 3-obwodowy, czarny, (33233) Track system component, TEAR N TR 2M-B, 3-circuit track, black, (33233)
 	TEAR N PCON R-W	33234	5905339332349	Element systemu szynowego, TEAR N PCON R-W, przyłącze prądowe z wtykiem R, białe, (33234) Track system component, TEAR N PCON R-W, power connector with plug R, white, (33234)
 	TEAR N PCON R-B	33235	5905339332356	Element systemu szynowego, TEAR N PCON R-B, przyłącze prądowe z wtykiem R, czarne, (33235) Track system component, TEAR N PCON R-B, power connector with plug R, black, (33235)
 	TEAR N PCON L-W	33260	5905339332608	Element systemu szynowego, TEAR N PCON L-W, przyłącze prądowe z wtykiem L, białe, (33260) Track system component, TEAR N PCON L-W, power connector with plug L, white, (33260)
 	TEAR N PCON L-B	33261	5905339332615	Element systemu szynowego, TEAR N PCON L-B, przyłącze prądowe z wtykiem L, czarne, (33261) Track system component, TEAR N PCON L-B, power connector with plug L, black, (33261)
	TEAR N EPLUG W	33236	5905339332363	Element systemu szynowego, TEAR N EPLUG W, zaślepka, biała, (33236) Track system component, TEAR N EPLUG W, end plug, white, (33236)
	TEAR N EPLUG B	33237	5905339332370	Element systemu szynowego, TEAR N EPLUG B, zaślepka, czarna, (33237) Track system component, TEAR N EPLUG B, end cap, black, (33237)
  	TEAR N ICON-I-W	33238	5905339332387	Element systemu szynowego, TEAR N ICON-I-W, łącznik prosty typu „I” wewnętrzny z wtykami L i R, biały, (33238) Track system component, TEAR N ICON-I-W, straight connector type „I” internal with plugs L, R, white, (33238)
  	TEAR N ICON-I-B	33239	5905339332394	Element systemu szynowego, TEAR N ICON-I-B, łącznik prosty typu „I” wewnętrzny z wtykami L i R, czarny, (33239) Track system component, TEAR N ICON-I-B, straight connector type „I” internal with plugs L, R, black, (33239)
  	TEAR N CON-I-W	33240	5905339332400	Element systemu szynowego, TEAR N CON-I-W, łącznik prosty typu „I” z wtykami L i R, biały, (33240) Track system component, TEAR N CON-I-W, straight connector type „I” with plugs L, R, white, (33240)
  	TEAR N CON-I-B	33241	5905339332417	Element systemu szynowego, TEAR N CON-I-B, łącznik prosty typu „I” z wtykami L i R, czarny, (33241) Track system component, TEAR N CON-I-B, straight connector type „I” with plugs L, R, black, (33241)
  	TEAR N CON-I-FLEX-W	33252	5905339332523	Element systemu szynowego, TEAR N CON-I-FLEX-W, łącznik elastyczny z wtykami L i R, biały, (33252) Track system component, TEAR N CON-I-FLEX-W, flexible connector with plugs L, R, white, (33252)
  	TEAR N CON-I-FLEX-B	33253	5905339332530	Element systemu szynowego, TEAR N CON-I-FLEX-B, łącznik elastyczny z wtykami L i R, czarny, (33253) Track system component, TEAR N CON-I-FLEX-B, flexible connector with plugs L, R, black, (33253)
  	TEAR N CON-L-RL-W	33242	5905339332424	Element systemu szynowego, TEAR N CON-L-RL-W, łącznik narożny typu „L” z wtykami R i L, biały, (33242) Track system component, TEAR N CON-L-RL-W, corner connector type „L” with plugs R, L, white, (33242)
  	TEAR N CON-L-RL-B	33243	5905339332431	Element systemu szynowego, TEAR N CON-L-RL-B, łącznik narożny typu „L” z wtykami R i L, czarny, (33243) Track system component, TEAR N CON-L-RL-B, corner connector type „L” with plugs R, L, black, (33243)
  	TEAR N CON-L-LR-W	33244	5905339332448	Element systemu szynowego, TEAR N CON-L-LR-W, łącznik narożny typu „L” z wtykami L i R, biały, (33244) Track system component, TEAR N CON-L-LR-W, corner connector type „L” with plugs L, R, white, (33244)
  	TEAR N CON-L-LR-B	33245	5905339332455	Element systemu szynowego, TEAR N CON-L-LR-B, łącznik narożny typu „L” z wtykami L i R, czarny, (33245) Track system component, TEAR N CON-L-LR-B, corner connector type „L” with plugs L, R, black, (33245)
  	TEAR N CON-X-W	33246	5905339332462	Element systemu szynowego, TEAR N CON-X-W, łącznik krzyżowy z wtykami L, L, R, R, biały, (33246) Track system component, TEAR N CON-X-W, cross connector with plugs L, L, R, R, white, (33246)

TEAR N

AKCESORIUM SYSTEMU SZYNOPRZEWODOWEGO ► ACCESSORY FOR ELECTRICAL SUPPLY TRACK SYSTEMS

		TEAR N CON-X B	33247	5905339332479	Element systemu szynowego, TEAR N CON-X B, łącznik krzyżowy z wtykami L, L, R, R, czarny, (33247) Track system component, TEAR N CON-X B, cross connector with plugs L, L, R, R, black, (33247)
		TEAR N CON-T RRL-W	33248	5905339332486	Element systemu szynowego, TEAR N CON-T RRL-W, łącznik typu „T” z wtykami R, R i L, biały, (33248) Track system component, TEAR N CON-T RRL-W, connector type „T” with plugs R, R, L, white, (33248)
		TEAR N CON-T RRL-B	33249	5905339332493	Element systemu szynowego, TEAR N CON-T RRL-B, łącznik typu „T” z wtykami R, R i L, czarny, (33249) Track system component, TEAR N CON-T RRL-B, connector type „T” with plugs R, R, L, black, (33249)
		TEAR N CON-T RLL-W	33250	5905339332509	Element systemu szynowego, TEAR N CON-T RLL-W, łącznik typu „T” z wtykami R, L i L, biały, (33250) Track system component, TEAR N CON-T RLL-W, connector type „T” with plugs R, L, L, white, (33250)
		TEAR N CON-T RLL-B	33251	5905339332516	Element systemu szynowego, TEAR N CON-T RLL-B, łącznik typu „T” z wtykami R, L i L, czarny, (33251) Track system component, TEAR N CON-T RLL-B, connector type „T” with plugs R, L, L, black, (33251)
		TEAR N CON-T LRR-W	33262	5905339332622	Element systemu szynowego, TEAR N CON-T LRR-W, łącznik typu „T” z wtykami L, R i R, biały, (33262) Track system component, TEAR N CON-T LRR-W, connector type „T” with plugs L, R, R, white, (33262)
		TEAR N CON-T LRR-B	33263	5905339332639	Element systemu szynowego, TEAR N CON-T LRR-B, łącznik typu „T” z wtykami L, R i R, czarny, (33263) Track system component, TEAR N CON-T LRR-B, connector type „T” with plugs L, R, R, black, (33263)
		TEAR N CON-T LLR-W	33264	5905339332646	Element systemu szynowego, TEAR N CON-T LLR-W, łącznik typu „T” z wtykami L, L i R, biały, (33264) Track system component, TEAR N CON-T LLR-W, connector type „T” with plugs L, L, R, white, (33264)
		TEAR N CON-T LLR-B	33265	5905339332653	Element systemu szynowego, TEAR N CON-T LLR-B, łącznik typu „T” z wtykami L, L i R, czarny, (33265) Track system component, TEAR N CON-T LLR-B, connector type „T” with plugs L, L, R, black, (33265)
		TEAR N SKIT W	33256	5905339332561	Element systemu szynowego, TEAR N SKIT W, zawieszanie z autoregulacją i linką 2m, białe, (33256) Track system component, TEAR N SKIT W, suspension with self-regulation and cord 2m, white, (33256)
		TEAR N SKIT B	33257	5905339332578	Element systemu szynowego, TEAR N SKIT B, zawieszanie z autoregulacją i linką 2m, czarne, (33257) Track system component, TEAR N SKIT B, suspension with self-regulation and cord 2m, black, (33257)
		TEAR N SCLAMP W	33254	5905339332547	Element systemu szynowego, TEAR N SCLAMP W, uchwyt montażowy/usztywniający, biały, (33254) Track system component, TEAR N SCLAMP W, mounting/stiffening suspension clamp, white, (33254)
		TEAR N SCLAMP B	33255	5905339332554	Element systemu szynowego, TEAR N SCLAMP B, uchwyt montażowy/usztywniający, czarny, (33255) Track system component, TEAR N SCLAMP B, mounting/stiffening suspension clamp, black, (33255)

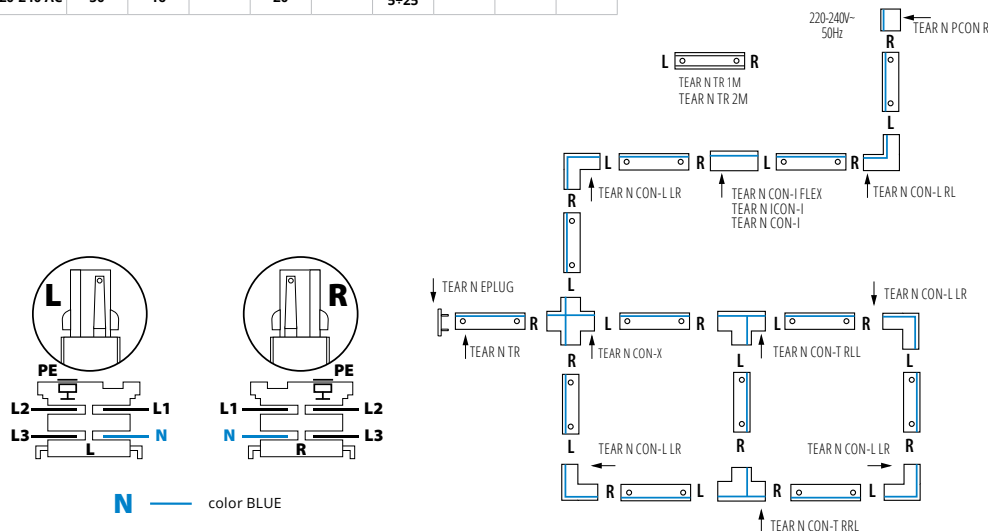

Kanlux



OSPRZĘT ELEKTROINSTALACYJNY
ELECTRICAL INSTALLATION EQUIPMENT

Zależy Ci na właściwie dobranych parametrach, wydajności i zabezpieczeniu termicznym, zwarciovym i przeciążeniowym. My damy Ci produkty przeznaczone do tych zadań. Zapewniamy komfort, niezawodność i bezpieczeństwo.

You want the properly adjusted parameters, efficiency and thermal, short-circuit and overload protection. We give you products designed for these tasks. We ensure comfort, reliability and safety.



*dane fotometryczne znajdziesz na:
photometric data you can find on:*

► kanlux.com

ALER MINI

CZUJNIK RUCHU PIR ► PIR MOTION SENSOR



ALER MINI-W

Czujnik ALER MINI-W to niewielki czujnik na podczerwień o efektywnym i minimalistycznym wyglądzie. Horyzontalny kąt działania czujnika wynosi 140°, a wertykalny 45°, a dzięki łatwej regulacji mechanicznej (pion 45°, poziom 90°) można dostosować go do swoich potrzeb. Posiada wysoką klasę szczelności (IP44), co sprawia, że czujnik ten można montować w miejscach bezpośrednio narażonych na działanie czynników atmosferycznych.

- maksymalny zasięg wykrywania ruchu wynoszący 8m
- maksymalny horyzontalny kąt działania czujnika ruchu wynoszący 140°
- możliwość regulacji czasu świecenia od 10s do 15min
- możliwość ustawienia poziomu natężenia oświetlenia otoczenia, przy którym urządzenie pracuje

Materiał: tworzywo sztuczne

ALER MINI-W sensor is a small infrared sensor with attractive and minimalistic design. The horizontal angle of the sensor work comes to 140°, and vertical 45°, and thanks to easy mechanical adjustment (vertical 45°, level 90°) it can be adapted to your needs. Owing to the high class of tightness (IP44), this sensor can be mounted in places directly exposed to weather conditions.

- Maximum movement detection up to 8m
- Maximum horizontal angle of operation of the motion sensor – 140°
- Light on time adjustable from 10s to 15min
- Capability to set the light intensity of the environment in which the device works

Materiał: plastic

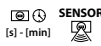

ALER MINI-W	23450	5905339234506	800	do nadbudowania na ścianie wall mounted	H140/V45	10-15	PIR
-------------	--------------	---------------	-----	--	----------	-------	-----

[V] 220-240 AC	[Hz] 50/60	IP 44				
[m] max 8	[lx] 3-2000	[°C] -20÷40		[mm] 1+2,5	CE	ERC

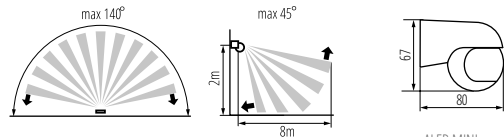

ALER MINI

ALER JQ

CZUJNIK RUCHU PIR ► PIR MOTION SENSOR



ALER JQ-30-W



ALER JQ-30-B

Kanlux ALER JQ to czujnik ruchu, którego maksymalny zasięg wykrywania wynosi 12 metrów. Możemy ustawić regulację czasu świecenia jak i poziom natężenia oświetlenia, przy którym czujnik pracuje.

Materiał: tworzywo sztuczne

Kanlux ALER JQ is a motion detector whose maximum detection range comes to 12 metres. You can set adjustments of the lighting time and light intensity level at which the detector works.

Materiał: plastic

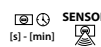

ALER JQ-30-W	00460	5905339004604	1200	do nadbudowania na ścianie wall mounted	H160/V20	8-7	PIR
ALER JQ-30-B	00461	5905339004611	1200	do nadbudowania na ścianie wall mounted	H160/V20	8-7	PIR

[V] 220-240 AC	[Hz] 50/60	IP 44				
[m] max 12	[lx] 3-2000	[°C] -20÷40		[mm] 1+2,5	CE	ERC

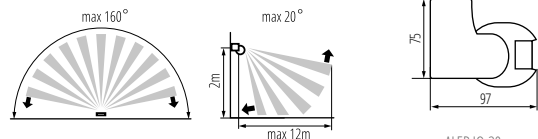

ALER JQ-30

Kanlux ZONA JQ

CZUJNIK RUCHU PIR ► PIR MOTION SENSOR



ZONA JQ-37-W



ZONA JQ-37-W	00464	5905339004642	1200	do nadbudowania na suficie ceiling mounted	H360/V120	15-7	PIR
--------------	-------	---------------	------	---	-----------	------	-----

[V] 220-240 AC	[Hz] 50/60	IP 20				
 max 10	 3-2000	 -20+40		 1+2,5	CE	ERAC

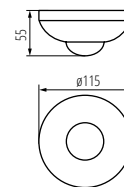
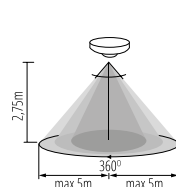

ZONA JQ-37

Kanlux ZONA JQ to czujnik ruchu, którego maksymalny zasięg wykrywania wynosi 10 metrów. Możemy ustawić regulacje czasu świecenia jak i poziom natężenia oświetlenia, przy którym czujnik pracuje.

maksymalny zasięg wykrywania ruchu wynoszący 10m

maksymalny horyzontalny kąt działania czujnika ruchu wynoszący 360°

maksymalny wertykalny kąt działania czujnika ruchu wynoszący 120°

możliwość regulacji czasu świecenia od 15s do 7min

możliwość ustawienia poziomu natężenia oświetlenia otoczenia, przy którym urządzenie pracuje

Materiał: tworzywo sztuczne

Kanlux ZONA JQ is a motion detector whose maximum detection range comes to 10 metres. You can set adjustments of the lighting time and light intensity level at which the detector works.

Maximum movement detection up to 10m

Maximum horizontal angle of operation of the motion sensor – 360°

Maximum vertical angle of operation of the motion sensor – 120°

Light on time adjustable from 15s to 7min

Capability to set the light intensity of the environment in which the device works

Material: plastic

Kanlux MARID JQ

CZUJNIK RUCHU PIR ► PIR MOTION SENSOR



MARID JQ-L



MARID JQ-L	08910	5905339089106	40-500	do wbudowania w ścianę Recessed mount in the wall	H150/V30	10-7	PIR
------------	-------	---------------	--------	--	----------	------	-----

[V] 220-240 AC	[Hz] 50/60	IP 20				
 max 12	 3-2000	 5+25		 0,75+2,5	CE	ERAC

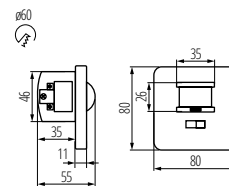
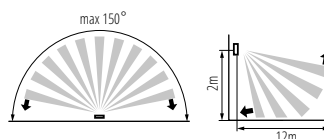
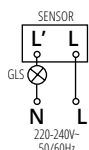

MARID JQ-L

Kanlux MARID JQ to czujnik ruchu, którego maksymalny zasięg wykrywania wynosi 12 metrów. Możemy ustawić regulacje czasu świecenia jak i poziom natężenia oświetlenia, przy którym czujnik pracuje. Czujnik można uruchamiać również sygnałem dźwiękowym.

maksymalny zasięg wykrywania ruchu wynoszący 12m

maksymalny horyzontalny kąt działania czujnika ruchu wynoszący 150°

maksymalny wertykalny kąt działania czujnika ruchu wynoszący 30°

możliwość regulacji czasu świecenia od 10s do 7min

możliwość ustawienia poziomu natężenia oświetlenia otoczenia, przy którym urządzenie pracuje

wykrywanie ruchu 0.3...3m/s (1...10km/h)

regulacja czułości w zakresie 3...1000lx

możliwość uruchamiania czujnika sygnałem dźwiękowym w zakresie 30-90dB

przeznaczony jest tylko do odbiorników o charakterze rezystancyjnym

Materiał: tworzywo sztuczne

Kanlux MARID JQ is a motion detector whose maximum detection range comes to 12 metres. You can set adjustments of the lighting time and light intensity level at which the detector works. The detector can be activated by means of sound signal too.

Maximum movement detection up to 12m

Maximum horizontal angle of operation of the motion sensor – 150°

Maximum vertical angle of operation of the motion sensor – 30°

Light on time adjustable from 10s to 7min

Capability to set the light intensity of the environment in which the device works

Motion detection 0.3...3m/s (1...10km/h)

Sensitivity adjustment in the range of 3...1000lx

Capability to activate the sensor with a 30-90db sound signal

Designed only for resistive loads

Material: plastic

Kanlux

MERGE JQ

CZUJNIK RUCHU PIR ► PIR MOTION SENSOR



MERGE JQ-L

Kanlux MERGE JQ-L to czujnik ruchu, którego maksymalny zasięg wykrywania wynosi 9 metrów. Horyzontalny kąt działania czujnika wynosi 150 stopni. Możemy ustawić regulację czasu świecenia jak i poziom natężenia oświetlenia, przy którym czujnik pracuje.

- maksymalny zasięg wykrywania ruchu wynoszący 9m
- maksymalny horyzontalny kąt działania czujnika ruchu wynoszący 150°
- maksymalny wertykalny kąt działania czujnika ruchu wynoszący 60°
- możliwość regulacji czasu świecenia od 10s do 7min
- możliwość ustawienia poziomu natężenia oświetlenia otoczenia, przy którym urządzenie pracuje
- obciążenie rezystancyjne wynoszące max 1200W, obciążenie impedancyjne wynoszące max 400W
- Materiał: tworzywo sztuczne

Kanlux MERGE JQ-L to czujnik ruchu, którego maksymalny zasięg wykrywania wynosi 9 metrów. Horyzontalny kąt działania czujnika wynosi 150 stopni. Możemy ustawić regulację czasu świecenia jak i poziom natężenia oświetlenia, przy którym czujnik pracuje.

- Maximum movement detection up to 9m
- Maximum horizontal angle of operation of the motion sensor – 150°
- Maximum vertical angle of operation of the motion sensor – 60°
- Light on time adjustable from 10s to 7min
- Capability to set the light intensity of the environment in which the device works
- Max 1200W resistive load, max. 400W inductive load
- Material: plastic



MERGE JQ-L | 07690 | 5905339076908 | 1200 | do wbudowania w ścianie / Recessed mount in the wall | H150/V60 | 10-7 | PIR

[V]	[Hz]	IP				
220-240 AC	50/60	20				
					CE	ERAC
max 9	3-2000	5+25		1+2,5		

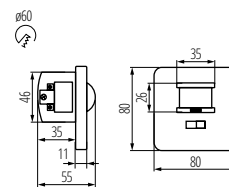
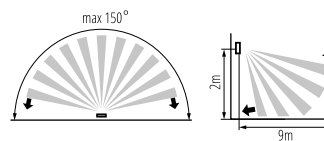
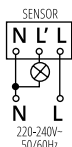

MERGE JQ-L

Kanlux

ROLF MINI JQ

CZUJNIK RUCHU MW ► MW MOTION SENSOR



ROLF MINI JQ-L

Kanlux ROLF JQ to mikrofalowy czujnik ruchu. Horyzontalny kąt działania czujnika wynosi 360 stopni. Możemy ustawić regulację czasu świecenia, jak i poziom natężenia oświetlenia, przy którym czujnik pracuje.

- maksymalny zasięg wykrywania ruchu wynoszący 10m
- maksymalny horyzontalny kąt działania czujnika ruchu wynoszący 360°
- maksymalny wertykalny kąt działania czujnika ruchu wynoszący 140°
- możliwość regulacji czasu świecenia od 10s do 30min
- możliwość ustawienia poziomu natężenia oświetlenia otoczenia, przy którym urządzenie pracuje
- regulacja czułości w zakresie 2...2000lx
- wykrywanie ruchu 0.3...3m/s (1...10km/h)
- Materiał: tworzywo sztuczne

Kanlux ROLF JQ is a motion detector. The horizontal angle of the detector work comes to 360 degrees. You can set adjustments of the lighting time and light intensity level at which the detector works.

- Maximum movement detection up to 10m
- Maximum horizontal angle of operation of the motion sensor – 360°
- Maximum vertical angle of operation of the motion sensor – 140°
- Light on time adjustable from 10s to 30min
- Capability to set the light intensity of the environment in which the device works
- Sensitivity adjustment in the range of 2...2000lx
- Motion detection 0.3...3m/s (1...10km/h)
- Material: plastic



ROLF MINI JQ-L | 08822 | 5905339088222 | 1200 | do nadbudowania na ścianie, do nadbudowania na suficie, do nadbudowania na podłożu | wall mounted, ceiling mounted, surface mounted | H360/V140 | 10-30 | mikrofalowy / microwave

[V]	[Hz]	IP				
220-240 AC	50/60	20				
					CE	ERAC
max 10	2-2000	5+25		1+2,5		

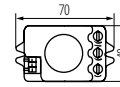
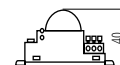
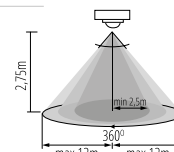

ROLF MINI JQ-L

Kanlux ROLF JQ

CZUJNIK RUCHU MW ► MW MOTION SENSOR



ROLF JQ-L

Kanlux ROLF JQ to mikrofalowy czujnik ruchu. Horizontalny kąt działania czujnika wynosi 360 stopni. Możemy ustawić regulacje czasu świecenia, jak i poziom natężenia oświetlenia, przy którym czujnik pracuje.

- maksymalny zasięg wykrywania ruchu wynoszący 8m
- maksymalny horizontalny kąt działania czujnika ruchu wynoszący 360°
- maksymalny wertykalny kąt działania czujnika ruchu wynoszący 160°
- możliwość regulacji czasu świecenia od 5s do 12min
- możliwość ustawienia poziomu natężenia oświetlenia otoczenia, przy którym urządzenie pracuje
- regulacja czułości w zakresie 2...2000lx
- wykrywanie ruchu 0.3...3m/s (1...10km/h)

Materiał: tworzywo sztuczne

Kanlux ROLF JQ is a motion detector. The horizontal angle of the detector work comes to 360 degrees. You can set adjustments of the lighting time and light intensity level at which the detector works.

- Maximum movement detection up to 8m
- Maximum horizontal angle of operation of the motion sensor – 360°
- Maximum vertical angle of operation of the motion sensor – 160°
- Light on time adjustable from 5s to 12min
- Capability to set the light intensity of the environment in which the device works
- Sensitivity adjustment in the range of 2...2000lx
- Motion detection 0.3...3m/s (1...10km/h)

Material: plastic

						SENSOR	
ROLF JQ-L	08820	5905339088208	1200	do nadbudowania na ścianie, do nadbudowania na suficie, do nadbudowania na podłożu wall mounted, ceiling mounted, surface mounted	H360/V160	5-12	mikrofalowy microwave

220-240 AC	50/60	IP 20				
max 8	2-2000	5+25		1+2,5		

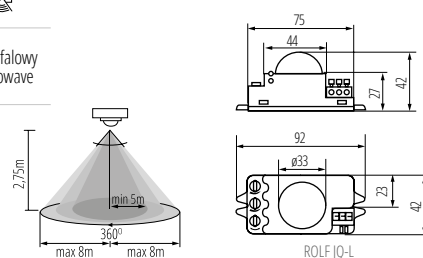

Kanlux SLICK JQ

CZUJNIK RUCHU PIR ► PIR MOTION SENSOR



SLICK JQ-L-W



SLICK JQ-L-B

Kanlux SLICK JQ to czujnik ruchu, którego maksymalny zasięg wykrywania wynosi 12 metrów. Możemy ustawić regulacje czasu świecenia jak i poziom natężenia oświetlenia, przy którym czujnik pracuje.

Materiał: tworzywo sztuczne

Kanlux SLICK JQ is a motion detector whose maximum detection range comes to 12 metres. You can set adjustments of the lighting time and light intensity level at which the detector works.

Material: plastic

						SENSOR	
SLICK JQ-L-W	08390	5905339083906	1200	do nadbudowania na ścianie wall mounted	H160/V20	8-10	PIR
SLICK JQ-L-B	08391	5905339083913	1200	do nadbudowania na ścianie wall mounted	H160/V20	8-10	PIR

220-240 AC	50/60	IP 44				
max 12	3-2000	-10+40		1+2,5		

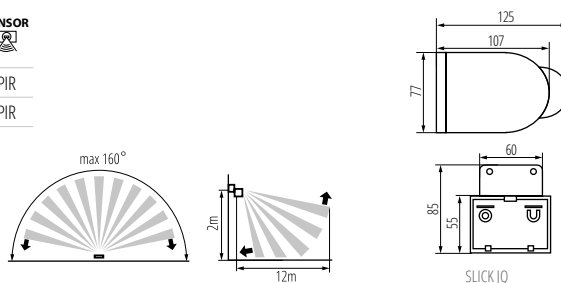

Kanlux

MERGE JQ

CZUJNIK RUCHU PIR ► PIR MOTION SENSOR



MERGE JQ-O

Kanlux MERGE JQ-O to czujnik ruchu, którego maksymalny zasięg wykrywania wynosi 5 metrów. Horyzontalny kąt działania czujnika wynosi 360 stopni. Możemy ustawić regulacje czasu świecenia jak i poziom natężenia oświetlenia, przy którym czujnik pracuje.

- maksymalny zasięg wykrywania ruchu wynoszący 5m
- maksymalny horyzontalny kąt działania czujnika ruchu wynoszący 360°
- maksymalny wertykalny kąt działania czujnika ruchu wynoszący 120°
- możliwość regulacji czasu świecenia od 5s do 6min
- możliwość ustawienia poziomu natężenia oświetlenia otoczenia, przy którym urządzenie pracuje
- obciążenie rezystancyjne wynoszące max 2000W, obciążenie impedancyjne wynoszące max 800W
- Materiał: tworzywo sztuczne

Kanlux MERGE JQ-O to czujnik ruchu, którego maksymalny zasięg wykrywania wynosi 5 metrów. Horyzontalny kąt działania czujnika wynosi 360 stopni. Możemy ustawić regulacje czasu świecenia jak i poziom natężenia oświetlenia, przy którym czujnik pracuje.

- Maximum movement detection up to 5m
- Maximum horizontal angle of operation of the motion sensor – 360°
- Maximum vertical angle of operation of the motion sensor – 120°
- Light on time adjustable from 5s to 6min
- Capability to set the light intensity of the environment in which the device works
- Max 2000W resistive load, max. 800W inductive load
- Materiał: plastic



MERGE JQ-O | 07691 | 5905339076915 | 2000 | do wbudowania w sufit
Recessed mount in the ceiling | H360/V120 | 5-6 | PIR

[V] 220-240 AC	[Hz] 50/60	IP 20			
[m] max 5	[lx] 3-2000	5+25	CE	EAC	F

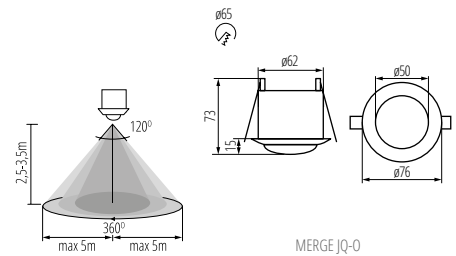

MERGE JQ-O

Kanlux

ROLF JQ

CZUJNIK RUCHU MW ► MW MOTION SENSOR



ROLF JQ-O

Kanlux ROLF JQ to mikrofalowy czujnik ruchu. Horyzontalny kąt działania czujnika wynosi 360 stopni. Możemy ustawić regulacje czasu świecenia, jak i poziom natężenia oświetlenia, przy którym czujnik pracuje.

- maksymalny zasięg wykrywania ruchu wynoszący 9m
- maksymalny horyzontalny kąt działania czujnika ruchu wynoszący 360°
- maksymalny wertykalny kąt działania czujnika ruchu wynoszący 160°
- możliwość regulacji czasu świecenia od 6s do 12min
- możliwość ustawienia poziomu natężenia oświetlenia otoczenia, przy którym urządzenie pracuje
- regulacja czułości w zakresie 2...2000lx
- wykrywanie ruchu 0.3...3m/s (1...10km/h)
- Materiał: tworzywo sztuczne

Kanlux ROLF JQ is a motion detector. The horizontal angle of the detector work comes to 360 degrees. You can set adjustments of the lighting time and light intensity level at which the detector works.

- Maximum movement detection up to 9m
- Maximum horizontal angle of operation of the motion sensor – 360°
- Maximum vertical angle of operation of the motion sensor – 160°
- Light on time adjustable from 6s to 12min
- Capability to set the light intensity of the environment in which the device works
- Sensitivity adjustment in the range of 2...2000lx
- Motion detection 0.3...3m/s (1...10km/h)
- Materiał: plastic



ROLF JQ-O | 08821 | 5905339088215 | 1200 | do nadbudowania na suficie
ceiling mounted | H360/V160 | 6-12 | mikrofalowy microwave

[V] 220-240 AC	[Hz] 50/60	IP 20			
[m] max 9	[lx] 2-2000	5+25	CE	EAC	F

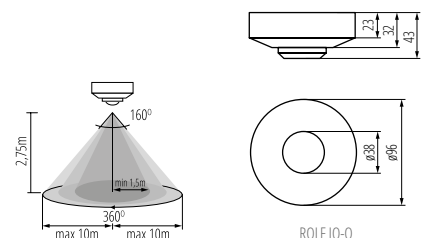

ROLF JQ-O

Kanlux MERGE O

CZUJNIK RUCHU PIR ► PIR MOTION SENSOR



MERGE ADJ-O



Kanlux MERGE ADJ to czujnik ruchu PIR o maksymalnym zasięgu wykrywania ruchu 5m. Jego maksymalny horizontalny kąt działania to 360 stopni. W czujniku MERGE ADJ masz możliwość regulacji nastaw parametrów bez konieczności demontażu czujnika.

maksymalny zasięg wykrywania ruchu wynoszący 5m
maksymalny horizontalny kąt działania czujnika ruchu wynoszący 360°
możliwość regulacji czasu świecenia od 10s do 15min
możliwość ustawienia poziomu natężenia oświetlenia otoczenia, przy którym urządzenie pracuje
wykrywanie ruchu 0.6-1.5m/s
maksymalny wertykalny kąt działania czujnika ruchu wynoszący 120°
Materiał: tworzywo sztuczne

Kanlux MERGE ADJ is a PIR motion detector with maximum motion detection range of 5m. Its maximum horizontal angle of work comes to 360 degrees. In the MERGE ADJ sensor, you can adjust settings of parameters without a necessity to disassemble the detector.

Maximum movement detection up to 5m
Maximum horizontal angle of operation of the motion sensor – 360°
Light on time adjustable from 10s to 15min
Capability to set the light intensity of the environment in which the device works
Motion detection 0.6...1.5m/s
Maximum vertical angle of operation of the motion sensor 120°
Material: plastic



MERGE ADJ-O	23451	5905339234513	800	do wbudowania w sufit Recessed mount in the ceiling	H360/V120	10-15	PIR
-------------	-------	---------------	-----	--	-----------	-------	-----

[V] 220-240 AC	[Hz] 50/60	IP 20				
 max 5	 3-2000	 5÷25	 0,75÷1,5			

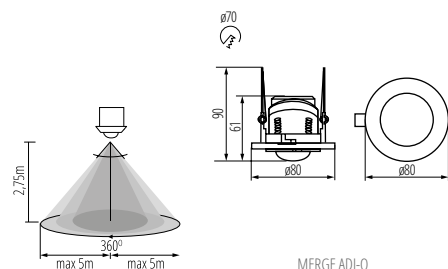

MERGE ADJ-O

Kanlux MERGE L

CZUJNIK RUCHU MW ► MW MOTION SENSOR



MERGE MW-L



Czujnik Kanlux MERGE MW to estetyczne i funkcjonalne rozwiązanie. Maksymalny zasięg wykrywania wynosi 9 metrów. Możemy ustawić regulacje czasu świecenia jak i poziom natężenia oświetlenia, przy którym czujnik pracuje.

maksymalny zasięg wykrywania ruchu wynoszący 9m
maksymalny horizontalny kąt działania czujnika ruchu wynoszący 180°
możliwość regulacji czasu świecenia od 10s do 12min
możliwość ustawienia poziomu natężenia oświetlenia otoczenia, przy którym urządzenie pracuje
wykrywanie ruchu 0.6-1.5m/s
maksymalny wertykalny kąt działania czujnika ruchu wynoszący 180°
Materiał: tworzywo sztuczne

Kanlux MERGE MW detector is an aesthetic and functional solution. The maximum detection range comes to 9 metres. You can set adjustments of the lighting time and light intensity level at which the detector works.

Maximum movement detection up to 9m
Maximum horizontal angle of operation of the motion sensor – 180°
Light on time adjustable from 10s to 12min
Capability to set the light intensity of the environment in which the device works
Motion detection 0.6...1.5m/s
Maximum vertical angle of operation of the motion sensor 180°
Material: plastic



MERGE MW-L	23453	5905339234537	1200	do wbudowania w ścianę Recessed mount in the wall	180	10-12	mikrofalowy microwave
------------	-------	---------------	------	--	-----	-------	--------------------------

[V] 220-240 AC	[Hz] 50/60	IP 20				
 max 9	 3-2000	 5÷25	 0,75÷1,5			

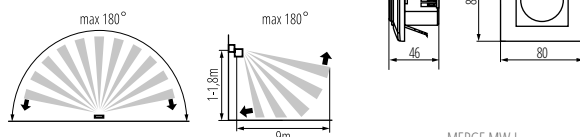

MERGE MW-L

Kanlux SENTO

CZUJNIK RUCHU PIR ► PIR MOTION SENSOR



SENTO



Kanlux SENTO to czujnik elektroniczny służący do wykrywania ruchu. Jego wyjątkowość polega na zabudowaniu aż trzech detektorów podczerwieni w jednej czujce. Gwarantuje to niespotykaną czułość i pozwala wychwycić nawet minimalny ruch. Kanlux SENTO, ze względu na nietypowe cechy, określamy jako czujniki obecności.

Material: tworzywo sztuczne

Kanlux SENTO is an electronic sensor for movement detection. Its exceptionality lies in the fact that as three infrared detectors are installed in one sensor. This guarantees an unprecedented sensitivity and allows you to capture even the slightest movement. Kanlux SENTO, due to its unusual features, is referred to as a presence detector.

Material: plastic

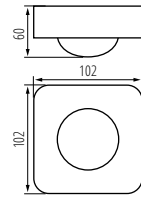
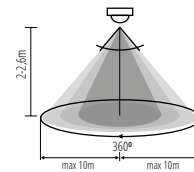
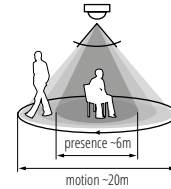

SENTO

SENTO	26820	5905339268204	2000	do nadbudowania na ścianie, do nadbudowania na suficie wall mounted, ceiling mounted	H360/V120	10-30	3xPIR

220-240 AC	50/60	20				
max 10	3-2000	5+25		0,75+1,5		

Kanlux SENZO

CZUJNIK RUCHU PIR ► PIR MOTION SENSOR



SENZO



Kanlux SENZO to czujnik ruchu PIR stosowany w systemach automatycznego załączania oświetlenia. Specjalne rozmieszczenie dwóch czujników podczerwieni w Kanlux SENZO pozwala na zastosowanie go w instalacjach wysokich pomieszczeń, takich jak hale magazynowe czy produkcyjne. Jego zasięg wertykalny to aż 10 metrów.

Material: tworzywo sztuczne

Kanlux SENZO is a PIR movement sensor used in automatic lighting switching systems. The special arrangement of two infrared sensors in Kanlux SENZO allows it to be used in high room installations, such as warehouses or production halls. Its vertical range is as much as 10 meters.

Material: plastic

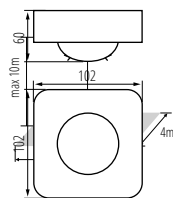
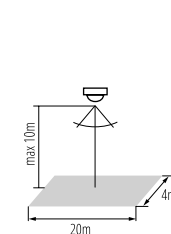

SENZO

SENZO	26821	5905339268211	2000	do nadbudowania na ścianie, do nadbudowania na suficie wall mounted, ceiling mounted	H360/V120	10-30	2xPIR

220-240 AC	50/60	20				
max 10	3-2000	5+25		0,75+1,5		



Kanlux ZONA

CZUJNIK RUCHU PIR ► PIR MOTION SENSOR



ZONA FLAT-W

Kanlux ZONA FLAT to czujnik ruchu o maksymalnym zasięgu wykrywania ruchu 8m. Jego z kolei maksymalny horyzontalny kąt działania to 360 stopni. W czujniku ZONA masz możliwość regulowania czasu świecenia od 10s do 15min a także ustawienia poziomu natężenia oświetlenia otoczenia przy którym urządzenie będzie pracowało.

maksymalny zasięg wykrywania ruchu wynoszący 8m
maksymalny horyzontalny kąt działania czujnika ruchu wynoszący 360°
możliwość regulacji czasu świecenia od 10s do 15min
możliwość ustawienia poziomu natężenia oświetlenia otoczenia, przy którym urządzenie pracuje
wykrywanie ruchu 0.6-1.5m/s
maksymalny wertykalny kąt działania czujnika ruchu wynoszący 120°
Materiał: tworzywo sztuczne

Kanlux ZONA FLAT is a motion detector with maximum motion detection range of 8m. In turn, its maximum horizontal angle of work comes to 360 degrees. In the ZONA sensor, you can adjust the time of lighting from 10s to 15min as well as set the surrounding light intensity level at which the device will work.

Maximum movement detection up to 8m
Maximum horizontal angle of operation of the motion sensor – 360°
Light on time adjustable from 10s to 15min
Capability to set the light intensity of the environment in which the device works
Motion detection 0.6...1.5m/s
Maximum vertical angle of operation of the motion sensor 120°
Material: plastic



ZONA FLAT-W | 23452 | 5905339234520 | 2000 | do nadbudowania na suficie ceiling mounted | H360/V120 | 10-15 | PIR

[V] 220-240 AC	[Hz] 50/60	IP 20				
 max 8	 3-2000 lx	 5+25 °C		 0,75+1,5	CE	EAC

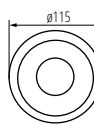
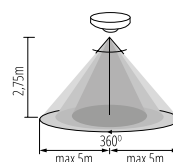

ZONA FLAT

Kanlux AZ-10A

PRZEKAŹNIK ZMIERZCHOWY ► TWILIGHT SWITCH



AZ-10A

Kanlux AZ-10A to automat zmierzchowy. Służy do włączania i wyłączenia obwodów oświetlenia lub innych odbiorników elektrycznych, w zależności od poziomu natężenia oświetlenia naturalnego (dzień/noc).

Histereza ~20Lx

Kanlux AZ-10 is a dusk and dawn light switch system. It is used for turning on and turning off lighting circuits or other electric receivers, depending on the natural light intensity level (day/night).

Hysteresis ~20Lx



AZ-10A | 22371 | 5905339223715 | biały | white | do nadbudowania na ścianie wall mounted

[V] 220-240 AC	[Hz] 50/60	In[A] 10	[VA] 2300	 -20+40 °C			IP 20/65		CE	EAC
-------------------	---------------	-------------	--------------	---------------	--	--	-------------	--	----	-----

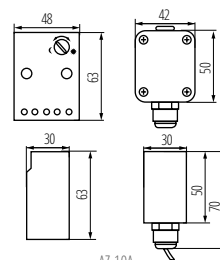

AZ-10A

Kanlux CYBER

ZEGAR/PROGRAMATOR STERUJĄCY ► CONTROL TIMER / PROGRAMMER



CYBER TM-6



CYBER TM-6 | 01016 | 5905339010162 | 3600 | 10

[V]	[Hz]	In[A]	IP	⌚	⏚	CE	EAC
220-240 AC	50/60	16(2)	20				

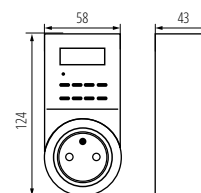

CYBER TM-6

Kanlux CYBER to adapter gniazda wtyczkowego z dobowym programatorem cyfrowym. Umożliwia zaprogramowanie włączania i wyłączenia podłączonych urządzeń w określonym czasie.

wyposażony w układ podtrzymujący pamięć
możliwość zaprogramowania max 10 włączeń/wyłączeń
programator pracuje w trybach dobowym i tygodniowym

Kanlux CYBER is an adapter of an extension socket with a 24-hour digital programmer. It makes it possible to programme turning on and turning off operations for connected devices at pre-set time.

Equipped with a memory keeping system
Up to 10 programmable on/off operations
The timer works in 24h and weekly mode

Kanlux STER TS-MF

ZEGAR/PROGRAMATOR STERUJĄCY ► CONTROL TIMER / PROGRAMMER



STER TS-MF-1



STER TS-MF1 | 01001 | 5905339010018 | 3500 | 1

[V]	[Hz]	In[A]	IP	⌚	⏚	CE	EAC
220-240 AC	50/60	16(2)	20				

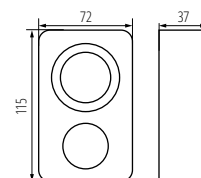

STER TS-MF-1

Kanlux STER TS-MF to adapter gniazda wtyczkowego z dobowym programatorem mechanicznym. Umożliwia zaprogramowanie włączania i wyłączenia podłączonych urządzeń w określonym czasie.

programator pracuje w trybie dobowym
minimalny czas włączenia/wyłączenia wynoszący 15min
programator posiada funkcję stałego załączenia obciążenia

Kanlux STER TS-MF is an adapter of an extension socket with a 24-hour mechanical programmer. It makes it possible to programme turning on and turning off operations for connected devices at pre-set time.

The timer works in 24h mode
Minimum on/off time 15min
Timer has constant load switching capability



ADI 350 1x3W



ADI 350 1x3W | 01440 | 5905339014405 | 220-240 AC | 1-3

[V] 220-240 AC	[Hz] 50/60	CC 	IP 20	PRI [V] 220-240	SEC [V] 0,5-10 DC	SEC [mA] 350	
			 0,75	 0,1	 5+25		

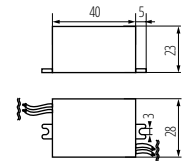

ADI 350 1x3W

Zasilacz elektroniczny o maksymalnej dopuszczalnej temperaturze obudowy 75°C i stabilizacji prądu 350mA DC. Posiada wbudowane zabezpieczenie przeciwzwarciowe i przeciwprzeciążeniowe oraz zabezpieczenie termiczne wyłączające zasilacz po przekroczeniu temperatury 110°C.

ADI 350 1-3W stabilizacja prądu 350mA DC

ADI 700 1x3W stabilizacja prądu 700mA DC

maksymalna dopuszczalna temperatura obudowy wynosząca 75°C

zabezpieczenie termiczne wyłączające zasilacz po przekroczeniu temperatury 110°C

wbudowane zabezpieczenie przeciwzwarciowe i przeciwprzeciążeniowe

Materiał: tworzywo sztuczne

Kanlux ADI electronic power supply unit - with maximum permissible temperature of casing 75°C and current stabilization 350mA DC - has an embedded protection against short circuits and against overload as well as a thermal protection turning off the power supply unit when the temperature of 110°C is exceeded.

ADI 350 1-3W current stabilization 350mA DC

ADI 700 1x3W current stabilization 700mA DC

Maximum permissible housing temperature 75°C

Thermal protection shutting down the power supply after the temperature exceeds 110°C

Built-in circuit and overload protection

Materiał: plastik



DRIFT LED 3-18W

DRIFT LED 0-6W

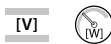

DRIFT LED 3-18W | 08550 | 5905339085504 | 220-240 AC | 3-18
 DRIFT LED 0-6W | 18040 | 5905339180407 | 220-240 AC | 0-6

[V] 220-240 AC	[Hz] 50/60	CV 	PRI [V] 220-240	SEC [V] 12 DC	
IP 20			 0,75	 0,1	 5+25

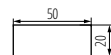
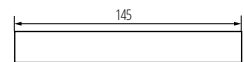

DRIFT LED 3-18W

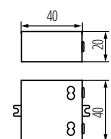

DRIFT LED 0-6W

Kanlux DRIFT to zasilacz elektroniczny stałonapięciowy o mocach 3-18 W lub 0-6 W. Służy do zasilania pasków LED takich jak LED S P czy LED S B.

stabilizacja napięcia 12V DC

wbudowane zabezpieczenie przeciwzwarciowe i przeciwprzeciążeniowe

model DRIFT LED 0-6W wyposażony w przewody 0,75mm2 długość 15cm / model DRIFT LED 3-18W podłączenie przez zaciski 0,5-1,5mm2

Materiał: tworzywo sztuczne

Kanlux DRIFT is an electronic constant-voltage power supply unit with power of 3-18 W or 0-6 W. It is used for powering LED belts such as LED S P or LED S B.

Voltage stabilization 12V DC

Built-in circuit and overload protection

DRIFT LED 0-6W is provided with 0.75mm2 cable 15cm length / DRIFT LED 3-18W connection via terminals 0.5-1.5mm2

Materiał: plastik

Kanlux CIRCO

ZASILACZ CV ► CV POWER SUPPLY UNIT



CIRCO LED

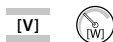

CIRCO LED 12VDC 0-10W	24240	5905339242402	220-240 AC	0-10
CIRCO LED 12VDC 0-15W	24241	5905339242419	220-240 AC	0-15

[V] 220-240 AC	[Hz] 50/60	CV	PRI [V] 220-240	SEC [V] 12 DC	F	IP 20
House icon	Square icon	Wiring icon	mm icon 0,5	Temp icon 5+25	CE	ERC

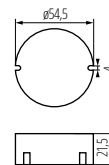

CIRCO LED

Kanlux CIRCO to zasilacz elektroniczny stałonapięciowy o mocy 10 lub 15 W. Służy do zasilania pasków LED takich jak LEDS P czy LEDS B.

Kanlux CIRCO is an electronic constant-voltage power supply unit with power of 10 or 15 W. It is used for powering LED belts such as LEDS P or LEDS B.

Kanlux DRIVE LED

ZASILACZ CV ► CV POWER SUPPLY UNIT



DRIVE LED 0-15W 12VDC



DRIVE LED 0-15W 12VDC	23860	5905339238603	220-240 AC	0-15
-----------------------	--------------	---------------	------------	------

[V] 220-240 AC	[Hz] 50/60	CV	PRI [V] 0-15	SEC [V] 12 DC	SEC (mA) max 1250	F
IP 20	House icon	Wiring icon	mm icon 0,75+1,5	Temp icon 5+25	CE	ERC

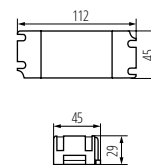

DRIVE LED 0-15W 12VDC

Kanlux DRIVE to zasilacz elektroniczny stałonapięciowy o mocy 15 W. Służy do zasilania pasków LED takich jak LEDS P czy LEDS B.

Materiał: tworzywo sztuczne

Kanlux DRIVE is an electronic constant-voltage power supply unit with power of 15 W. It is used for powering LED belts such as LEDS P or LEDS B.

Materiał: plastic

Kanlux POWELED

ZASILACZ CV ► CV POWER SUPPLY UNIT



POWELED P 12V 30W



POWELED P 12V 30W	26810	5905339268105	220-240 AC	0-30
POWELED P 12V 60W	26811	5905339268112	220-240 AC	0-60

[V] 220-240 AC	[Hz] 50/60	CV	PRI [V] 220-240	SEC [V] 12 DC	F	IP 20
House icon	Square icon	Wiring icon	mm icon 0,5-1,5	Temp icon 5+25	CE	ERC

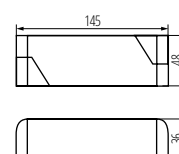

POWELED P 12V 30W

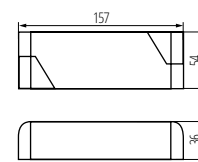

POWELED P 12V 60W

Kanlux POWELED to zasilacz elektroniczny stałonapięciowy. Służy do zasilania pasków LED takich jak Kanlux LEDS-P czy Kanlux LEDS-B.

Materiał: tworzywo sztuczne

Kanlux POWELED is an electronic constant-voltage power supply unit. It is used for powering LED belts such as LEDS P or LEDS B.

Materiał: plastic

Kanlux RICO LED

ZASILACZ CC ► CC POWER SUPPLY UNIT



RICO LED 10-18W

Kanlux RICO LED to zasilacz elektroniczny ze stabilizacją prądu 350/700mA DC. Posiada wbudowane zabezpieczenie przeciwzwarciowe i przeciwprzeciążeniowe oraz zabezpieczenie termiczne wyłączające zasilacz po przekroczeniu temperatury 110°C.

Materiał: tworzywo sztuczne

Kanlux RICO LED is an electronic power supply unit with current stabilization of 350/700mA DC. It has an embedded protection against short circuits and against overload as well as a thermal protection turning off the power supply unit when the temperature of 110°C is exceeded.

Materiał: plastic



RICO LED 10-18W | 07302 | 5905339073020 | 10...18 x 1 | 350

[V] 220-240 AC	[Hz] 50/60	CC	PRI [V] 220-240	F	IP 20	House icon
□	⊕	→ [mm] 0,75-1,5	⊕ [°C] 5+25	CE	ERAC	

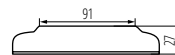
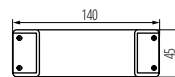

RICO LED 10-18W

Kanlux STEL LED

ZASILACZ CC ► CC POWER SUPPLY UNIT



STEL LED 350 8-12W

Kanlux STEL LED to zasilacz elektroniczny ze stabilizacją prądu 350mA DC. Posiada wbudowane zabezpieczenie przeciwzwarciowe i przeciwprzeciążeniowe oraz zabezpieczenie termiczne wyłączające zasilacz po przekroczeniu temperatury 110°C.

Materiał: tworzywo sztuczne

Kanlux STEL LED is an electronic power supply unit with current stabilization of 350mA DC. It has an embedded protection against short circuits and against overload as well as a thermal protection turning off the power supply unit when the temperature of 110°C is exceeded.

Materiał: plastic



STEL LED 350 8-12W | 23070 | 5905339230706 | 8-12 | 350

[V] 220-240 AC	[Hz] 50/60	CC	PRI [V] 220-240	F	IP 20	House icon
□	⊕	→ [mm] 0,5	→ [m] 0,13	⊕ [°C] 5+25	CE	ERAC

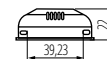
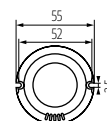

STEL LED

Kanlux SET

TRANSFORMATOR ELEKTRONICZNY SET

► SET ELECTRONIC TRANSFORMER



SET60-K



SET60-K | 01425 | 5905339014252 | 220-240 AC | 20-60
SET105-K | 01426 | 5905339014269 | 220-240 AC | 35-105

[V] 220-240 AC	[Hz] 50/60	PRI [V] 220-240	SEC [V] 11,5 AC	F	IP 20	House icon
□	⊕	→ [mm] 0,75-1,5	⊕ [°C] 5+25	CE	ERAC	

wyrob przeznaczony do zasilania niskonapięciowych żarówek halogenowych (12V)

współczynnik mocy biernej $\cos\phi$ dla SET60-K i SET105-K wynoszący 0,99, dla SET80LT, SET150-N i SET210-N wynoszący 0,97

maksymalna dopuszczalna temperatura obudowy dla SET60-K wynosząca 80°C, dla pozostałych modeli wynosząca 85°C

zabezpieczenie termiczne wyłączające model SET80LT po przekroczeniu temperatury 100°C, modele SET150-N i SET210-N po przekroczeniu temperatury 110°C, modele SET60-K i SET105-K po przekroczeniu temperatury 120°C

wbudowane zabezpieczenie przeciwzwarciowe i przeciwprzeciążeniowe

product designed for feeding low voltage halogen light bulbs (12V)

Reactive power factor $\cos\phi$ 0.99 for SET60-K i SET105-K, for SET80LT, SET150-N and SET210-N – 0.97

Maximum permissible housing temperature 80°C for SET60-K, for other models – 85°C

Thermal protection shutting down SET80LT after the temperature exceeds 100°C, for SET150-N and SET210-N – after exceeding 110°C, for SET60-K and SET105-K – after exceeding 120°C

Built-in circuit and overload protection

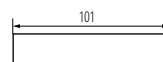

SET60-K

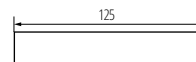

SET105-K

Kanlux

TRETO LED

ZASILACZ CV ► CV POWER SUPPLY UNIT



TRETO LED 30W



TRETO LED 30W | **07800** | 5905339078001 | 220-240 AC | 0-30

[V] 220-240 AC	[Hz] 50/60	CV	PRI [V] 220-240	SEC [V] 12 DC	SEC [mA] max 2500	F	IP 66
				 -20+50			

Kanlux TRETO to zasilacz elektroniczny stałonapięciowy o mocy 30 W. Służy do zasilania pasków LED takich jak LEDS P czy LEDS B.

stabilizacja napięcia 12V DC

maksymalna dopuszczalna temperatura obudowy wynosząca 65°C

wbudowane zabezpieczenie przeciwzwarciowe

wbudowane układy redukcji zakłóceń radioelektrycznych i poprawy współczynnika mocy

Materiał: stop aluminium

Kanlux TRETO is an electronic constant-voltage power supply unit with power of 30 W. It is used for powering LED belts such as LEDS P or LEDS B.

Voltage stabilization 12V DC

Maximum permissible housing temperature 65°C

Built-in circuit and overload protection

Built-in radio interference reduction and power factor correction systems

Material: aluminum alloy

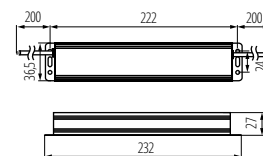

TRETO LED 30W

Kanlux

DIMGO

ŚCIEMNIACZ LED ► DIMMER LED



DIMGO 105

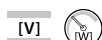

DimGO 105 | **28830** | 5905339288301 | 230 AC | 8-105

[V] 230 AC	[Hz] 50/60		IP 20	 5+25				
---------------	---------------	--	----------	----------	--	--	--	--

Kanlux DimGO to ściemniacz przystosowany do źródeł światła LED. Dzięki zastosowaniu go uzyskujemy możliwość sterowania strumieniem świetlnym źródeł światła LED. Warunkiem zastosowania Kanlux DimGO jest zasilanie przystosowane do regulacji metodą „trailing/leading edge”.

Materiał: tworzywo sztuczne

Kanlux DimGO is a dimmer adapted to LED light sources. It gives you the possibility of controlling the luminous flux of LED light sources. The prerequisite for using the DimGO Kanlux is a power supply adapted to the “trailing/leading edge” adjustment method.

Materiał: plastic

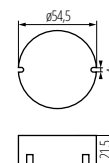

DIMGO 105



model BLV2-3-4x14H-EVG służy do stabilizacji prądu świetlówek T5, pozostałe modele służą do stabilizacji prądu świetlówek T8

Materiał: stal

BLV2-3-4x14H-EVG is used for T5 fluorescent lamps current stabilisation, other models are used for T8 fluorescent lamps current stabilisation

Material: steel



BLV2-3-4x14H-EVG



BLV2-3-4x14H-EVG



BLV2-118H-EVG



BLV2-136H-EVG

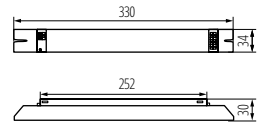

BLV2-3-4x14H-EVG; BLV2-418H-EVG



BLV2-118H-EVG; BLV2-136H-EVG; BLV2-218H-EVG

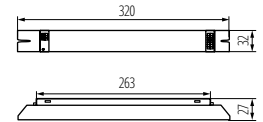

BLV2-158H-EVG; BLV2-236H-EVG; BLV2-258H-EVG



BLV2-3-4x14H-EVG	08248	5905339082480	3...4 x 14	T5
BLV2-118H-EVG	08241	5905339082411	1 x 18	T8
BLV2-136H-EVG	08242	5905339082428	1 x 36	T8
BLV2-158H-EVG	08243	5905339082435	1 x 58	T8
BLV2-218H-EVG	08244	5905339082442	2 x 18	T8
BLV2-236H-EVG	08245	5905339082459	2 x 36	T8
BLV2-258H-EVG	08246	5905339082466	2 x 58	T8
BLV2-418H-EVG	08247	5905339082473	4 x 18	T8

[V]	[Hz]	IP	EVG	WALLAST	mm ²	°C	CE	EAC
220-240 AC	50/60	20			0,5-1,5	-25+50		



BS-1 4-22W



BS-1 4-22W	07180	5905339071804	4-22
BS-2 4-65W	07181	5905339071811	4-65

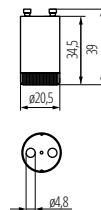

BS

Kanlux

WIR ZL

WENTYLATOR KANAŁOWY ► DUCTED FAN



WIR ZL100



WIR ZL100



WIR ZL120



Przepustnice samoczynne z serii Kanlux WIR ZL dostępne są w dwóch rozmiarach 100 oraz 120mm. Wykonane z tworzywa sztucznego, w kolorze białym.

Automatic dampers from Kanlux WIR ZL series are available in two sizes: 100 and 120mm. They are made of plastic, in white colour.



WIR ZL100	70961	8594056490349	biały white
WIR ZL120	70962	8594056490356	biały white

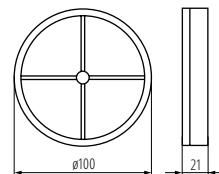

WIR ZL100

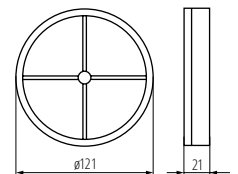

WIR ZL120

TWISTER

WENTYLATOR KANAŁOWY ► DUCTED FAN



TWISTER AOL100B



TWISTER AOL100B



TWISTER AOL100T



TWISTER AOL120B

Seria wentylatorów Kanlux TWISTER AOL dostępna jest w dwóch rozmiarach średnicy 100 i 120 mm. Wykonane są z tworzywa sztucznego, w kolorze białym. Ich moc to odpowiednio 19 i 20 W. Ilość obrotów z każdego rozmiaru wynosi 2550/min.

Kanlux TWISTER AOL series of fans is available in two sizes with diameter of 100 and 120 mm. They are made of plastic, in white colour. Their power is 19 and 20 W respectively. The number of rotations from each size comes to 2550/min.

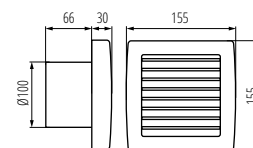

TWISTER AOL100B; TWISTER AOL100T

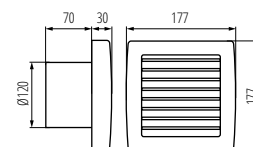

TWISTER AOL120B; TWISTER AOL120T



TWISTER AOL100B	70926	8594056490172	19	42	100	
TWISTER AOL100T	70953	8594056490202	19	42	100	tak yes
TWISTER AOL120B	70956	8594056490226	20	42	150	
TWISTER AOL120T	70960	8594056490257	20	42	150	tak yes

[V] 220-240 AC	[Hz] 50/60	IP X4				 2550		1	CE	EAC
--------------------------	----------------------	-----------------	--	--	--	----------	--	----------	-----------	------------

Kanlux CYKLON

WENTYLATOR KANAŁOWY ► DUCTED FAN



Seria wentylatorów Kanlux CYKLON EOL dostępna jest w trzech rozmiarach średnicy 100, 120 oraz 150mm. Wykonane są z tworzywa sztucznego, w kolorze białym. Ich moc to odpowiednio 19, 20 oraz 22W. Ilość obrotów z każdego rozmiaru wynosi 2550/min.

Ilość obrotów wynosząca 2550/min

Kanlux CYKLON EOL series of fans is available in three sizes with diameter of 100, 120 and 150mm. They are made of plastic, in white colour. Their power is 19, 20 and 22W respectively. The number of rotations from each size comes to 2550/min.

Rotation speed: 2550/min

CYKLON EOL100



CYKLON EOL100



CYKLON EOL100B



CYKLON EOL120



CYKLON EOL100	70910	8594056490011	19	38	100	tak yes		przewód zakończony wtyczką Cable terminated with a plug
CYKLON EOL100B	70911	8594056490028	19	38	100			kostka przyłączeniowa Terminal block
CYKLON EOL120	70915	8594056490066	20	38	150	tak yes		przewód zakończony wtyczką Cable terminated with a plug
CYKLON EOL120B	70916	8594056490073	20	38	150			kostka przyłączeniowa Terminal block
CYKLON EOL150	70920	8594056490110	22	38	200	tak yes		przewód zakończony wtyczką Cable terminated with a plug
CYKLON EOL150B	70921	8594056490127	22	38	200			kostka przyłączeniowa Terminal block
CYKLON EOL100HT	70936	8594056490035	19	38	100	tak yes	tak yes	kostka przyłączeniowa Terminal block
CYKLON EOL100P	70937	8594056490370	19	38	100		tak yes	kostka przyłączeniowa Terminal block
CYKLON EOL100T	70938	8594056490059	19	38	100		tak yes	kostka przyłączeniowa Terminal block
CYKLON EOL120HT	70941	8594056490080	20	38	150	tak yes	tak yes	kostka przyłączeniowa Terminal block
CYKLON EOL120P	70942	8594056490387	20	38	150		tak yes	kostka przyłączeniowa Terminal block
CYKLON EOL120T	70943	8594056490103	20	38	150		tak yes	kostka przyłączeniowa Terminal block
CYKLON EOL150P	70947	8594056490394	22	38	200		tak yes	kostka przyłączeniowa Terminal block
CYKLON EOL150T	70948	8594056490158	22	38	200		tak yes	kostka przyłączeniowa Terminal block

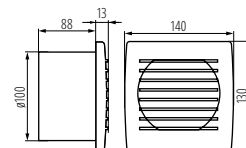

CYKLON EOL100; CYKLON EOL100B

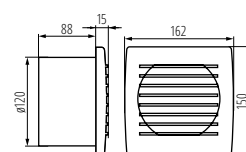

CYKLON EOL120; CYKLON EOL120B



Kanlux LUNGA

PRZEDŁUŻACZ LUNGA ► LUNGA EXTENSION CORD



LUNGA 3 3G1.0X1.4M



LUNGA 3 3G1.0X3M

LUNGA 3 3G1.0X5M

LUNGA 5 3G1.0X5M

Kanlux LUNGA to białe, wielogniazdowe przedłużacze domowe z uziemieniem. Dostępna szeroka gama produktów z ilością od 3 do 6 gniazd. W zależności od potrzeb proponujemy wersję z przełącznikiem lub bez.

Materiał: tworzywo sztuczne

Kanlux LUNGA are white, multi-socket home extension cords with earthing. A wide range of products available with 3-6 sockets. Depending on needs, we propose a version with a switch or without a switch.

Materiał: plastic

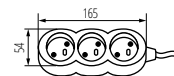

LUNGA 3

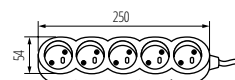

LUNGA 5



	[V]	[Hz]	[W]	[A]	[m]
LUNGA 3 3G1.0X1.4M	25950	5905339259509	1,4	2500	10
LUNGA 3 3G1.0X3M	26500	5905339265005	3	2500	10
LUNGA 3 3G1.0X5M	26501	5905339265012	5	2500	10
LUNGA 5 3G1.0X5M	26505	5905339265050	5	2500	10



Kanlux

LUNGA S

PRZEDŁUŻACZ LUNGA ► LUNGA EXTENSION CORD



LUNGA S3 3G1.0X1.4M



LUNGA S3 3G1.0X3M

LUNGA S4 3G1.0X3M

LUNGA S5 3G1.0X3M

Kanlux LUNGA S to białe, wielogniazdowe przedłużacze domowe z uziemieniem. Dostępna szeroka gama produktów z ilością od 3 do 6 gniazd. W zależności od potrzeb proponujemy wersję z przełącznikiem lub bez.

Materiał: tworzywo sztuczne

Kanlux LUNGA S are white, multi-socket home extension cords with earthing. A wide range of products available with 3-6 sockets. Depending on needs, we propose a version with a switch or without a switch.

Materiał: plastic

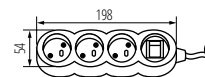

LUNGA S3

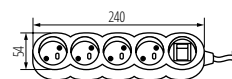

LUNGA S4

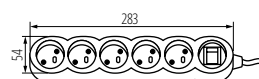

LUNGA S5



	[V]	[Hz]	[In(A)]	[m]	[In(A)]
LUNGA S3 3G1.0X1.4M	25954	5905339259547	1,4	2500	10
LUNGA S3 3G1.0X3M	26508	5905339265081	3	2500	10
LUNGA S3 3G1.0X5M	26509	5905339265098	5	2500	10
LUNGA S4 3G1.0X3M	26510	5905339265104	3	2500	10
LUNGA S5 3G1.0X3M	26512	5905339265128	3	2500	10



Kanlux

NOKA W

PRZEDŁUŻACZ NOKA W ► NOKA W EXTENSION CORD



NOKA W 10A 3G1.0X3M



			[m]	3G1.0mm ²	In [A]
NOKA W 10A 3G1.0X3M	26201	5905339262011	3	2500	10
NOKA W 10A 3G1.0X5M	26202	5905339262028	5	2500	10
NOKA W 10A 3G1.0X10M	26204	5905339262042	10	2500	10



Kanlux NOKA to kompletna oferta przedłużaczy elektrycznych do zastosowań w domu lub w ogrodzie. Do wyboru mamy dwie wersje różniące się kolorem i przeznaczeniem – białe o długość od 2m do 10m (z uziemieniem) oraz pomarańczowe (kosiarkowe) bez uziemienia o długościach 10m, 15m, 20m, 30m i 40m.

Materiał: tworzywo sztuczne

Kanlux NOKA is a complete offer of electric extension cords for use at home or in a garden. You can choose two versions different in terms of colour and intended use – white with length from 2m to 10m (with earthing) and orange (mower-type) without earthing with lengths of 10m, 15m, 20m, 30m and 40m.

Materiał: plastic

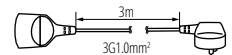

NOKA W 10A 3G1.0X3M

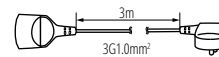

NOKA W 10A 3G1.0X5M

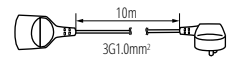

NOKA W 10A 3G1.0X10M

Kanlux

NOKA O

PRZEDŁUŻACZ NOKA O ► NOKA O EXTENSION CORD



NOKA O 16A 3G1.5X25M



			[m]	3G1.5mm ²	In [A]
NOKA O 16A 3G1.5X25M	26207	5905339262073	25	3600	16
NOKA O 16A 3G1.5X30M	26208	5905339262080	30	3600	16



Kanlux NOKA to kompletna oferta przedłużaczy elektrycznych do zastosowań w domu lub w ogrodzie. Do wyboru mamy dwie wersje różniące się kolorem i przeznaczeniem – białe o długość od 2m do 10m (z uziemieniem) oraz pomarańczowe (kosiarkowe) bez uziemienia o długościach 10m, 15m, 20m, 30m i 40m.

Materiał: tworzywo sztuczne

Kanlux NOKA is a complete offer of electric extension cords for use at home or in a garden. You can choose two versions different in terms of colour and intended use – white with length from 2m to 10m (with earthing) and orange (mower-type) without earthing with lengths of 10m, 15m, 20m, 30m and 40m.

Materiał: plastic

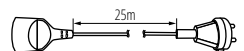

NOKA O 16A 3G1.5X25M

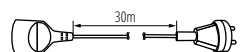

NOKA O 16A 3G1.5X30M

Kanlux DIVISO

ROZGAŁĘŻNIKI, GNIAZDA, WTYCZKI ► SPLITTERS, SOCKETS, PLUGS



DIVISO W3

DIVISO to rodzina kompaktowych rozdzielaczy na wtyczki płaskie. Dostępne w trzech rodzajach. Wykonane z tworzywa sztucznego, w kolorze białym.

Materiał: tworzywo sztuczne

DIVISO to rodzina kompaktowych rozdzielaczy na wtyczki płaskie. Dostępne w trzech rodzajach. Wykonane z tworzywa sztucznego, w kolorze białym.

Materiał: plastic



DIVISO W3 | 26091 | 5905339260918 biały | white

[V] 250 AC	[Hz] 50/60	[W] 1875	[Inch] 3 x 2,5	IP 20	CE
---------------	---------------	-------------	-------------------	----------	----

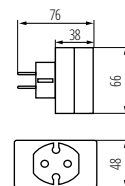

DIVISO W3

Kanlux GP-2

ROZGAŁĘŻNIKI, GNIAZDA, WTYCZKI ► SPLITTERS, SOCKETS, PLUGS



GP-2

gniazdo wtyczkowe do przedłużaczy.

Materiał: tworzywo sztuczne

extension socket for cable cords.

Materiał: plastic



GP-2 | 70513 | 5905339705136 biały | white

[V] 250 AC	[Hz] 50/60	[Inch] 16	IP 20	CE
---------------	---------------	--------------	----------	----

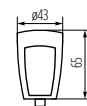

GP-2

Kanlux GRIP

ROZGAŁĘŻNIKI, GNIAZDA, WTYCZKI ► SPLITTERS, SOCKETS, PLUGS



GRIP GP/S



GRIP W/US

gniazdo wtyczkowe do przedłużaczy.

STAN GP posiada I klasę ochronności przed porażeniem elektrycznym

GRIP GP/S wyposażony w uziemienie typu Schuko

Materiał: tworzywo sztuczne

extension socket for cable cords.

STAN GP has I Class protection against electric shock

GRIP GP/S equipped with Schuko earthing

Materiał: plastic



GRIP GP/S | 04862 | 5905339048622 czarny | black
GRIP W/US | 04863 | 5905339048639 czarny | black

[V] 250 AC	[Hz] 50/60	[Inch] 16	IP 44	CE
---------------	---------------	--------------	----------	----

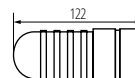

GRIP GP/S

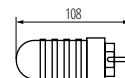

GRIP W/US

Kanlux

PIN W/US

ROZGAŁĘŻNIKI, GNIAZDA, WTYCZKI ► SPLITTERS, SOCKETS, PLUGS



PIN W/US

gniazdo wtyczkowe do przedłużaczy.
wyposażone w styk ochronny
Materiał: tworzywo sztuczne
extension socket for cable cords.
Equipped with protective contact
Material: plastic



PIN W/US | **02186** | 5905339021861 | biały | white

[V] 250 AC	[Hz] 50/60			In[A] 16	IP 20	CE
---------------	---------------	--	--	-------------	----------	----

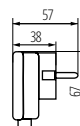

PIN W/US

Kanlux

STAN GP

ROZGAŁĘŻNIKI, GNIAZDA, WTYCZKI STAN GP ► STAN GP SPLITTERS, SOCKETS, PLUGS



STAN GP

gniazdo wtyczkowe do przedłużaczy.
Materiał: tworzywo sztuczne
extension socket for cable cords.
Material: plastic



STAN GP | **04864** | 5905339048646 | czarny | black

[V] 250 AC	[Hz] 50/60		In[A] 16	IP 44	CE
---------------	---------------	--	-------------	----------	----

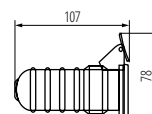

STAN GP

Kanlux

W-1 NANO

ROZGAŁĘŻNIKI, GNIAZDA, WTYCZKI ► SPLITTERS, SOCKETS, PLUGS



NANO W-1

gniazdo wtyczkowe do przedłużaczy.
Materiał: tworzywo sztuczne
extension socket for cable cords.
Material: plastic



NANO W-1 | **70514** | 5905339705143 | biały | white

[V] 250 AC	[Hz] 50/60		In[A] 16	IP 20	CE
---------------	---------------	--	-------------	----------	----

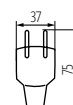

NANO W-1

Kanlux ZARK

ROZGAŁĘŹNIKI, GNIAZDA, WTYCZKI ► SPLITTERS, SOCKETS, PLUGS



ZARK KRT/2-1



ZARK KRT/2-1	02180	5905339021809	biały white
ZARK KRW-3	02181	5905339021816	biały white

[V] 250 AC	[Hz] 50/60	[W] 2300			In[A] 16	IP 20	CE
----------------------	----------------------	--------------------	--	--	--------------------	-----------------	-----------

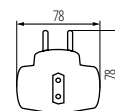

ZARK KRT/2-1

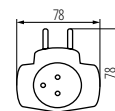

ZARK KRW-3

Brakuje Ci miejsca do podłączenia kolejnego urządzenia do kontaktu? Nic, prostszego, rozgałęźniki Kanlux ZARK rozwiążą Twój problem. Zyskasz tym samym trzy nowe wejścia do kontaktu.

wyposażony w styk ochronny

Materiał: tworzywo sztuczne

Don't you have enough room for connecting another device to the socket? Nothing simpler - Kanlux ZARK distributors will solve your problem. Thereby, you will have three new inputs to the socket.

Equipped with protective contact

Material: plastic

Kanlux APO

ZEGAR/PROGRAMATOR STERUJĄCY ► CONTROL TIMER / PROGRAMMER



APO TM-3



APO TM-3	07980	5905339079800	1150	5
----------	--------------	---------------	------	---

[V] 220-240 AC	[Hz] 50/60	In[A] 5	IP 20			CE	EAC
--------------------------	----------------------	-------------------	-----------------	--	--	-----------	------------

Kanlux APO to komplet 3 adapterów gniazd wtyczkowych z możliwością zdalnego sterowania za pomocą pilota. Każde podłączone urządzenie możemy uruchamiać niezależnie od innych.

w komplecie: 3 gniazda, pilot, bateria

przy obciążeniu indukcyjnym maksymalne obciążenie wynosi 1150W

gniazdka instalować można obok siebie w odległości nie mniejszej niż 0,5m

dioda sygnalizuje pracę gniazdka elektrycznego

zasięg działania pilota wynosi 25m (do 50m w otwartej przestrzeni)

Kanlux APO is a set of 3 adapters of extension sockets with a possibility of remote control by means of a remote control. Each connected device can be activated independently of others.

in the set: 3 sockets, remote control, battery

Maximum load with inductive load 1150W

Sockets can be installed next to one another at a distance of at least 0,5m

LED indicates that the electrical socket is operational

Remote control range 25m (up to 50m in the open space)

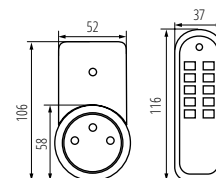

APO TM-3

Kanlux

BR-GZ10

OPRAWKA DO ŹRÓDEŁ ŚWIATŁA ► LIGHT SOURCE FITTING



BR-GZ10



BR-GZ10 | **72369** | 5905339723697 szary | grey

[V] 250 AC	[Hz] 50/60	In[A] 2		IP 00		
----------------------	----------------------	-------------------	--	-----------------	--	--

maksymalna dopuszczalna temperatura oprawki dla BR-GZ10, HLDR-GZ10, HLDR-R7S wynosząca 250°C, dla pozostałych modeli wynosząca 180°C
maksymalny dopuszczalny prąd dla BR-GZ10, HLDR-GZ10, HLDR-G9 wynoszący 2A, dla HLDR-R7S wynoszący 6A, dla HLDR-GX5.3 wynoszący 5A
BR-GZ10 wyposażona we wspornik
Maximum permissible holder temperature 250°C for BR-GZ10, HLDR-GZ10, HLDR-R7S, for other models – 180°C
Maximum permissible current for BR-GZ10, HLDR-GZ10, HLDR-G9 – 2A, for HLDR-R7S – 6A, for HLDR-GX5.3 – 5A
BR-GZ10 equipped with a support

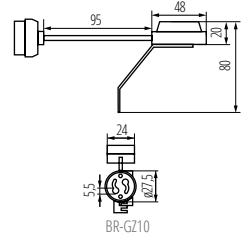

Kanlux

HLDR-E14

OPRAWKA DO ŹRÓDEŁ ŚWIATŁA ► LIGHT SOURCE FITTING



HLDR-E14



HLDR-E14 | **02170** | 5905339021700 szary | grey

[V] 250 AC	[Hz] 50/60	In[A] 2		IP 00		
----------------------	----------------------	-------------------	--	-----------------	--	--

maksymalna dopuszczalna temperatura oprawki wynosząca 180°C
Maximum permissible holder temperature 180°C

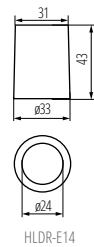

Kanlux

HLDR-E14-F

OPRAWKA DO ŹRÓDEŁ ŚWIATŁA ► LIGHT SOURCE FITTING



HLDR-E14-F



HLDR-E14-F | **02173** | 5905339021731 szary | grey

[V] 250 AC	[Hz] 50/60	In[A] 2		IP 00		
----------------------	----------------------	-------------------	--	-----------------	--	--

maksymalna dopuszczalna temperatura oprawki wynosząca 180°C
Maximum permissible holder temperature 180°C

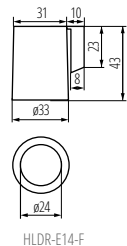

Kanlux

HLDR-E27

OPRAWKA DO ŹRÓDEŁ ŚWIATŁA ► LIGHT SOURCE FITTING



HLDR-E27



HLDR-E27 | 02160 | 5905339021601 szary | grey

[V] 250 AC	[Hz] 50/60	In[A] 4	E27	IP 00	
----------------------	----------------------	-------------------	------------	-----------------	--



| maksymalna dopuszczalna temperatura oprawki wynosząca 180°C
| Maximum permissible holder temperature 180°C

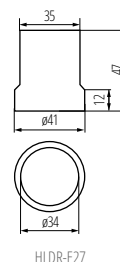

HLDR-E27

Kanlux

HLDR-E27-D

OPRAWKA DO ŹRÓDEŁ ŚWIATŁA ► LIGHT SOURCE FITTING



HLDR-E27-D



HLDR-E27-D | 02162 | 5905339021625 szary | grey

[V] 250 AC	[Hz] 50/60	In[A] 4	E27	IP 00	
----------------------	----------------------	-------------------	------------	-----------------	--



| maksymalna dopuszczalna temperatura oprawki wynosząca 180°C
| Maximum permissible holder temperature 180°C

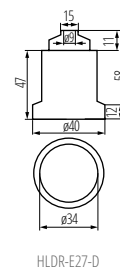

HLDR-E27-D

Kanlux

HLDR-E27-F

OPRAWKA DO ŹRÓDEŁ ŚWIATŁA ► LIGHT SOURCE FITTING



HLDR-E27-F



HLDR-E27-F | 02161 | 5905339021618 szary | grey

[V] 250 AC	[Hz] 50/60	In[A] 4	E27	IP 00	
----------------------	----------------------	-------------------	------------	-----------------	--



| maksymalna dopuszczalna temperatura oprawki wynosząca 180°C
| Maximum permissible holder temperature 180°C

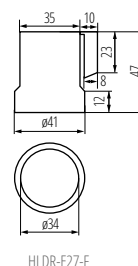

HLDR-E27-F

Kanlux

HLDR-G9

OPRAWKA DO ŹRÓDEŁ ŚWIATŁA ► LIGHT SOURCE FITTING



HLDR-G9



HLDR-G9 | **08220** | 5905339082206 szary | grey

[V] 250 AC	In[A] 2	G9	IP 00	CE
----------------------	-------------------	-----------	-----------------	-----------

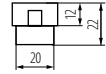

HLDR-G9

maksymalna dopuszczalna temperatura oprawki dla BR-GZ10, HLDR-GZ10, HLDR-R7S wynosząca 250°C, dla pozostałych modeli wynosząca 180°C
maksymalny dopuszczalny prąd dla BR-GZ10, HLDR-GZ10, HLDR-G9 wynoszący 2A, dla HLDR-R7S wynoszący 6A, dla HLDR-GX5.3 wynoszący 5A
BR-GZ10 wyposażona we wspornik
Maximum permissible holder temperature 250°C for BR-GZ10, HLDR-GZ10, HLDR-R7S, for other models – 180°C
Maximum permissible current for BR-GZ10, HLDR-GZ10, HLDR-G9 – 2A, for HLDR-R7S – 6A, for HLDR-GX5.3 – 5A
BR-GZ10 equipped with a support

Kanlux

HLDR-GX5.3

OPRAWKA DO ŹRÓDEŁ ŚWIATŁA ► LIGHT SOURCE FITTING



HLDR-GX5.3



HLDR-GX5,3 | **72109** | 5905339721099 szary | grey

[V] 24 AC; 24 DC	In[A] 5	Gx5,3	IP 00	CE
-------------------------------	-------------------	--------------	-----------------	-----------

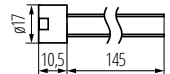

HLDR-GX5.3

maksymalna dopuszczalna temperatura oprawki dla BR-GZ10, HLDR-GZ10, HLDR-R7S wynosząca 250°C, dla pozostałych modeli wynosząca 180°C
maksymalny dopuszczalny prąd dla BR-GZ10, HLDR-GZ10, HLDR-G9 wynoszący 2A, dla HLDR-R7S wynoszący 6A, dla HLDR-GX5.3 wynoszący 5A
BR-GZ10 wyposażona we wspornik
Maximum permissible holder temperature 250°C for BR-GZ10, HLDR-GZ10, HLDR-R7S, for other models – 180°C
Maximum permissible current for BR-GZ10, HLDR-GZ10, HLDR-G9 – 2A, for HLDR-R7S – 6A, for HLDR-GX5.3 – 5A
BR-GZ10 equipped with a support

Kanlux

HLDR-GZ10

OPRAWKA DO ŹRÓDEŁ ŚWIATŁA ► LIGHT SOURCE FITTING



HLDR-GZ10



HLDR-GZ10 | **00402** | 5905339004024 szary | grey

[V] 250 AC	In[A] 2	GU10	IP 00	CE
----------------------	-------------------	-------------	-----------------	-----------

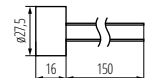

HLDR-GZ10

maksymalna dopuszczalna temperatura oprawki dla BR-GZ10, HLDR-GZ10, HLDR-R7S wynosząca 250°C, dla pozostałych modeli wynosząca 180°C
maksymalny dopuszczalny prąd dla BR-GZ10, HLDR-GZ10, HLDR-G9 wynoszący 2A, dla HLDR-R7S wynoszący 6A, dla HLDR-GX5.3 wynoszący 5A
BR-GZ10 wyposażona we wspornik
Maximum permissible holder temperature 250°C for BR-GZ10, HLDR-GZ10, HLDR-R7S, for other models – 180°C
Maximum permissible current for BR-GZ10, HLDR-GZ10, HLDR-G9 – 2A, for HLDR-R7S – 6A, for HLDR-GX5.3 – 5A
BR-GZ10 equipped with a support

Kanlux

HLDR-R7S

OPRAWKA DO ŹRÓDEŁ ŚWIATŁA ► LIGHT SOURCE FITTING



HLDR-R7S



HLDR-R7S | 00405 | 5905339004055 szary | grey

[V] 250 AC	[In[A] 6	[R7s]	IP 00	CE
---------------	-------------	-------	----------	----

maksymalna dopuszczalna temperatura oprawki dla BR-GZ10, HLDR-GZ10, HLDR-R7S wynosząca 250°C, dla pozostałych modeli wynosząca 180°C

maksymalny dopuszczalny prąd dla BR-GZ10, HLDR-GZ10, HLDR-G9 wynoszący 2A, dla HLDR-R7S wynoszący 6A, dla HLDR-GXS.3 wynoszący 5A

BR-GZ10 wyposażona we wspornik

Maximum permissible holder temperature 250°C for BR-GZ10, HLDR-GZ10, HLDR-R7S, for other models – 180°C

Maximum permissible current for BR-GZ10, HLDR-GZ10, HLDR-G9 – 2A, for HLDR-R7S – 6A, for HLDR-GXS.3 – 5A

BR-GZ10 equipped with a support

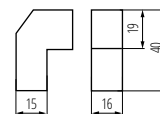

HLDR-R7S

Kanlux

HLDR-E14/GU10

PRZEJŚCIÓWKA DO ŹRÓDEŁ ŚWIATŁA ► ADAPTOR FOR LIGHT SOURCES



HLDR-E14/GU10



HLDR-E14/GU10 | 08851 | 5905339088512 biały | white

[V] 250 AC	[Hz] 50/60	[In[A] 2	IP 00	[W] 35	CE
---------------	---------------	-------------	----------	-----------	----

maksymalna dopuszczalna temperatura oprawki wynosząca 180°C

maksymalna dopuszczalna moc źródła światła 35W

Materiał: stop metali niekorodujących

Maximum permissible holder temperature 180°C

Maximum permissible light source power 35W

Material: non-corrosive metals alloy

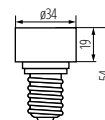

HLDR-E14/GU10

Kanlux

HLDR-E27/GU10

PRZEJŚCIÓWKA DO ŹRÓDEŁ ŚWIATŁA ► ADAPTOR FOR LIGHT SOURCES



HLDR-E27/GU10



HLDR-E27/GU10 | 08850 | 5905339088505 biały | white

[V] 250 AC	[Hz] 50/60	[In[A] 2	IP 00	[W] 35	CE
---------------	---------------	-------------	----------	-----------	----

maksymalna dopuszczalna temperatura oprawki wynosząca 180°C

maksymalna dopuszczalna moc źródła światła 35W

Materiał: stop metali niekorodujących

Maximum permissible holder temperature 180°C

Maximum permissible light source power 35W

Material: non-corrosive metals alloy

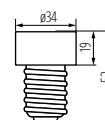

HLDR-E27/GU10

Kanlux

ONTEC S

ZESTAW DO MONTAŻU PODTYNKOWEGO ► SET FOR CONCEALED MOUNTING



ZEST. MONT. P/T ONTEC S

ZEST. MONT. P/T ONTEC S | 27398 | 5902052506422

Kanlux

ONTEC S

ZESTAW DO MONTAŻU PODTYNKOWEGO ► SET FOR CONCEALED MOUNTING



ZEST. MONT. FLAGI ONTEC S

ZEST. MONT. FLAGI | 27397 | 5902052506415

ONTEC R

OPRAWA AWARYJNA LED ► EMERGENCY LIGHTING LED



ONTECRM2302MAT/W

Oświetlenie awaryjne lub antypaniczne stosuje się w pomieszczeniach typu Open Space, aby przeciwdziałać panice. Pozwala na dotarcie do miejsca, w którym widać oznaczoną drogę ewakuacji jak i samej ewakuacyjnej zależnie od pryzmy zastosowanej w oprawie.

Materiał obudowy: tworzywo sztuczne

Materiał klosza: tworzywo sztuczne



Emergency or anti-panic lighting is used in open space rooms to prevent panic. It allows you to reach a place where you can see the marked escape route as well as for the illumination of the escape route itself, depending on the prism used in the fixture.

Enclosure material: plastic

Lampshade material: plastic



ZESTAW MONT. P/T ONTEC R

				MODE	USE	 ^[m]	ST	AT
OntecRM2302MAT/W	27731	5902052556823	2	awaryjno-sieciowy emergency and network	oświetlenie antypaniczne anti-panic lighting	3		✓
OntecRM5105MAT/W	27732	5902052570331	5	awaryjno-sieciowy emergency and network	oświetlenie antypaniczne anti-panic lighting	1		✓
OntecRC1302MAT/W	27739	5902052558667	2	awaryjno-sieciowy emergency and network	oświetlenie drogi ewakuacyjnej lighting of escape routes	3		✓
OntecRM5105MST/W	27850	5902052570355	5	awaryjno-sieciowy emergency and network	oświetlenie antypaniczne anti-panic lighting	1	✓	

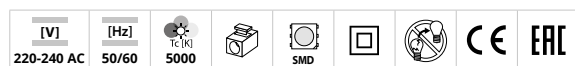

AKCESORIA ► ACCESSORIES

ZESTAW OR-M.WPUSZCZB	27948	5902052588688	Akcesoria do opraw awaryjnych LED
ZESTAW OR-M.WPUSZCZG	27949	5902052509935	Akcesoria do opraw awaryjnych LED
ZEST.MONT.P/T ONTEC R	27399	5902052588671	Akcesoria do opraw awaryjnych LED

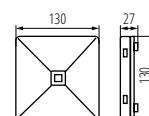

ONTEC R M

ONTEC G

OPRAWA AWARYJNA LED ► EMERGENCY LIGHTING LED



ONTEC G AT005 301



ZEST. MONT. P/T

Oświetlenie awaryjne lub antypaniczne stosuje się w pomieszczeniach typu Open Space, aby przeciwdziałać panice. Pozwala na dotarcie do miejsca, w którym widać oznaczoną drogę ewakuacji jak i oznaczenie samej drogi ewakuacyjnej zależnie od pryzmy zastosowanej w oprawie.

Materiał obudowy: tworzywo sztuczne

Materiał klosza: tworzywo sztuczne

Emergency or anti-panic lighting is used in open space rooms to prevent panic. It allows you to reach a place where you can see the marked escape route as well as for the illumination of the escape route itself, depending on the prism used in the fixture.

Enclosure material: plastic

Lampshade material: plastic



MODE

USE



ST

AT

				MODE	USE	ST	AT
ONTEC G AT005 301	25435	5902052515899	1	awaryjno-sieciowy emergency and network	wyznaczanie kierunku ewakuacji marking of escape routes	3	✓
ONTEC G E1B 101 M ST	27394	5902052515868	1	awaryjno-sieciowy emergency and network	wyznaczanie kierunku ewakuacji marking of escape routes	1	✓
ONTEC G E1B 301M ST/W	27395	5902052511365	1	awaryjno-sieciowy emergency and network	wyznaczanie kierunku ewakuacji marking of escape routes	3	✓
ONTECGE1B101MAT/W	27750	5902052515905	1	awaryjno-sieciowy emergency and network	wyznaczanie kierunku ewakuacji marking of escape routes	1	✓



AKCESORIA ► ACCESSORIES

ZEST.MONT.P/T ONTEC G	27051	5902052588640	Akcesoria do opraw awaryjnych LED
ZESTAW OG-M.WPUSZCZG	27947	5902052588664	Akcesoria do opraw awaryjnych LED
ZESTAW OG-M.WPUSZCZB	27946	5902052588657	Akcesoria do opraw awaryjnych LED

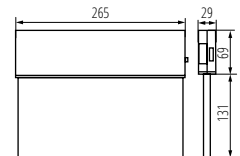

ONTEC G

ONTEC C

OPRAWA AWARYJNA LED ► EMERGENCY LIGHTING LED



ONTECCM2302MAT/W

Oświetlenie awaryjne lub antypaniczne stosuje się w pomieszczeniach typu Open Space, aby przeciwdziałać panice. Pozwala na dotarcie do miejsca, w którym widać oznaczoną drogę ewakuacji jak i oznaczenie samej drogi ewakuacyjnej zależnie od pryzmy zastosowanej w oprawie.

Materiał obudowy: tworzywo sztuczne

Materiał klosza: tworzywo sztuczne

Emergency or anti-panic lighting is used in open space rooms to prevent panic. It allows you to reach a place where you can see the marked escape route as well as for the illumination of the escape route itself, depending on the prism used in the fixture.

Enclosure material: plastic

Lampshade material: plastic



MODE

USE



ST

AT

				MODE	USE	ST	AT
ONTECCM2302MAT/W	27673	5902052556106	2	awaryjno-sieciowy emergency and network	oświetlenie drogi ewakuacyjnej lighting of escape routes	3	✓
ONTECCM2302MST/W	27839	5902052556045	2	awaryjno-sieciowy emergency and network	oświetlenie drogi ewakuacyjnej lighting of escape routes	3	✓

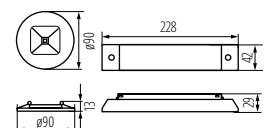

ONTEC C 1, M2

VIP ST2

MODUŁ AWARYJNY ► EMERGENCY UNITS



VIP 136 ST 2

Kanlux VIP to zestaw zasilania awaryjnego do fluorescencyjnych źródeł światła. Przeznaczony jest do montażu w oprawach oświetleniowych.

Materiał obudowy: tworzywo sztuczne

Kanlux VIP is an emergency power kit for fluorescent light sources. It is designed for installation in lighting fixtures.

Enclosure material: plastic



VIP 158 ST 2

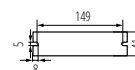
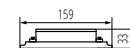

VIP ST 2

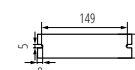
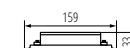

VIP 158 ST 2



MODE



ST AT

VIP 136 ST 2	27400	5902052504084	4-36	awaryjno-sieciowy emergency and network	1	✓
VIP 158 ST 2	27401	5902052504114	4-58	awaryjno-sieciowy emergency and network	1	✓

[V]	[Hz]	IP	CE	ERAC
230 AC	50	20		



PICTO ONTEC G TMP1



PICTO ONTEC G TMP1



PICTO ONTEC G TMP11



PICTO ONTEC G TMP22



PICTO ONTEC G TMP2



PICTO ONTEC G TMP12



PICTO ONTEC G TMP23



PICTO ONTEC G TMP5



PICTO ONTEC G TMP13



PICTO ONTEC G TMP50



PICTO ONTEC G TMP6



PICTO ONTEC G TMP14



PICTO ONTEC G TMP51



PICTO ONTEC G TMP7



PICTO ONTEC G TMP15



PICTO ONTEC G TMP67



PICTO ONTEC G TMP8



PICTO ONTEC G TMP16



PICTO ONTEC G TMP68



PICTO ONTEC G TMP9



PICTO ONTEC G TMP17



PICTO ONTEC G TMP10



PICTO ONTEC G TMP18

PICTO ONTEC G TMP1	27480	5905339274809
PICTO ONTEC G TMP2	27481	5905339274816
PICTO ONTEC G TMP5	27482	5905339274823
PICTO ONTEC G TMP6	27483	5905339274830
PICTO ONTEC G TMP7	27484	5905339274847
PICTO ONTEC G TMP8	27485	5905339274854
PICTO ONTEC G TMP9	27486	5905339274861
PICTO ONTEC G TMP10	27487	5905339274878
PICTO ONTEC G TMP11	27488	5905339274885
PICTO ONTEC G TMP12	27489	5905339274892
PICTO ONTEC G TMP13	27490	5905339274908
PICTO ONTEC G TMP14	27491	5905339274915
PICTO ONTEC G TMP15	27492	5905339274922
PICTO ONTEC G TMP16	27493	5905339274939
PICTO ONTEC G TMP17	27494	5905339274946
PICTO ONTEC G TMP18	27495	5905339274953
PICTO ONTEC G TMP22	27497	5905339274977
PICTO ONTEC G TMP23	27498	5905339274984
PICTO ONTEC G TMP67	27499	5905339274991
PICTO ONTEC G TMP68	27500	5905339275004
PICTO ONTEC G TMP50	27501	5905339275011
PICTO ONTEC G TMP51	27502	5905339275028

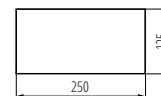

PICTO ONTEC G



PICTO ONTEC S TMP1



PICTO ONTEC S TMP1



PICTO ONTEC S TMP11



PICTO ONTEC S TMP21



PICTO ONTEC S TMP2



PICTO ONTEC S TMP12



PICTO ONTEC S TMP22



PICTO ONTEC S TMP5



PICTO ONTEC S TMP13



PICTO ONTEC S TMP23



PICTO ONTEC S TMP6



PICTO ONTEC S TMP14



PICTO ONTEC S TMP67



PICTO ONTEC S TMP7



PICTO ONTEC S TMP15



PICTO ONTEC S TMP68



PICTO ONTEC S TMP8



PICTO ONTEC S TMP16



PICTO ONTEC S TMP50



PICTO ONTEC S TMP9



PICTO ONTEC S TMP17



PICTO ONTEC S TMP51



PICTO ONTEC S TMP10



PICTO ONTEC S TMP18

PICTO ONTEC S TMP1	27503	5905339275035
PICTO ONTEC S TMP2	27504	5905339275042
PICTO ONTEC S TMP5	27505	5905339275059
PICTO ONTEC S TMP6	27506	5905339275066
PICTO ONTEC S TMP7	27507	5905339275073
PICTO ONTEC S TMP8	27508	5905339275080
PICTO ONTEC S TMP9	27509	5905339275097
PICTO ONTEC S TMP10	27510	5905339275103
PICTO ONTEC S TMP11	27511	5905339275110
PICTO ONTEC S TMP12	27512	5905339275127
PICTO ONTEC S TMP13	27513	5905339275134
PICTO ONTEC S TMP14	27514	5905339275141
PICTO ONTEC S TMP15	27515	5905339275158
PICTO ONTEC S TMP16	27516	5905339275165
PICTO ONTEC S TMP17	27517	5905339275172
PICTO ONTEC S TMP18	27518	5905339275189
PICTO ONTEC S TMP21	27519	5905339275196
PICTO ONTEC S TMP22	27520	5905339275202
PICTO ONTEC S TMP23	27521	5905339275219
PICTO ONTEC S TMP67	27522	5905339275226
PICTO ONTEC S TMP68	27523	5905339275233
PICTO ONTEC S TMP50	27524	5905339275240
PICTO ONTEC S TMP51	27525	5905339275257

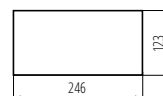

PICTO ONTEC S

Kanlux STRAP

OPASKA ZACISKOWA STRAP ► STRAP CABLE TIE



STRAP 2,5/100MM



STRAP 2,5/100MM	07962	5905339079626	biały white
STRAP 2,5/120MM	07963	5905339079633	biały white
STRAP 2,5/150MM	07965	5905339079657	biały white
STRAP 3,6/150MM	07966	5905339079664	biały white
STRAP 3,6/200MM	07967	5905339079671	biały white
STRAP 3,6/250MM	07968	5905339079688	biały white
STRAP 3,6/300MM	07969	5905339079695	biały white
STRAP 4,6/200MM	07970	5905339079701	biały white
STRAP 4,6/250MM	07971	5905339079718	biały white
STRAP 4,6/300MM	07972	5905339079725	biały white

odporność na promieniowanie UV, mikroorganizmy, bakterie i pleśń
opakowanie jednostkowe zawierające 100 szt.

Materiał: poliamid

Resistant to UV, micro-organisms, bacteria and mould
unit package containing 100 pcs.

Materiał: poliamid

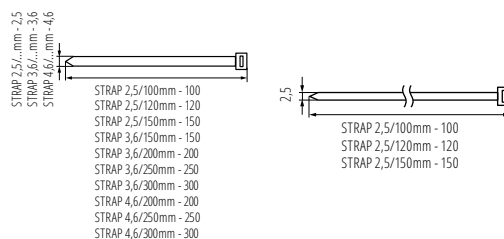

STRAP 2,5

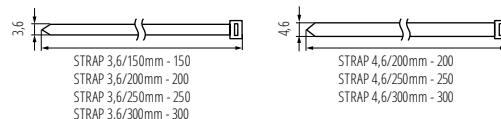

STRAP 3,6

STRAP 4,6

Kanlux IT

SAMOPRZYLEPNA TAŚMA IZOLACYJNA ► SELF-ADHESIVE INSULATION TAPE



IT-1/10-B



IT-1/10-B	01257	5905339012579	czarny black
IT-1/20-B	01271	5905339012715	czarny black
IT-1/20-Y	01272	5905339012722	żółty yellow
IT-1/20-RE	01273	5905339012739	czerwony red
IT-1/20-GN	01274	5905339012746	zielony green
IT-1/20-BL	01275	5905339012753	niebieski blue
IT-1/20-W	01276	5905339012760	biały white
IT-1/20-Y/GN	01277	5905339012777	żółty / zielony yellow / green
IT-1/20-MIX	01283	5905339012838	wielokolorowy multicoloured

IT-1: oferowane wyłącznie w opakowaniach podzbiorczych (10 szt.)

IT-1/20- MIX: unit package containing 10 pcs.

IT-1: offered only in sub-packaging (10 pcs.)

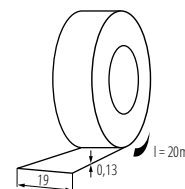

IT-1/20-B

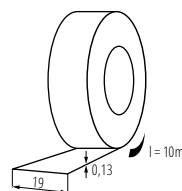

IT-1/10-B

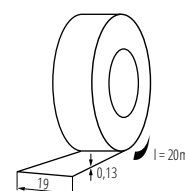

IT-1/20-Y





STOSOWANE IKONKI USED SYMBOLS



IP Objaśnienia stopnia odporności na wnikanie ciał stałych, pyłu i wilgoci Explanation of degree of resistance to penetration of foreign solids, dust and humidity

Stopień zabezpieczenia przed nieumyślnym kontaktem z częściami pod napięciem
Degree of protection against inadvertent contact with the live parts

IP	Rysunek / Picture	Opis / Description	Wyjaśnienie / Explanation
0		Brak ochrony No protection	Brak specjalnych środków ochrony No special protection means
1		Ochrona przed ciałami stałymi o wielkości ponad 50mm Protection against solids bigger than 50mm	Duża powierzchnia ciała ludzkiego, równa np. powierzchni dłoni (brak zabezpieczenia przed dotykiem). Ciała stałe o średnicy ponad 50mm Large parts of a human body, equal to e.g. the area of a palm (no protection against touching). Solids with the diameter above 50mm
2		Ochrona przed ciałami stałymi przekraczającymi 12mm Protection against solids bigger than 12mm	Palec lub podobne przedmioty o długości nie przekraczającej 80mm. Ciała stałe o średnicy nie przekraczającej 12mm A finger or similar objects not longer than 80mm. Solids with the diameter above 12mm
3		Ochrona przed ciałami stałymi przekraczającymi 2,5mm Protection against solids bigger than 2,5mm	Narzędzia, drut, itp. o średnicy lub grubości przekraczającej 2,5mm. Ciała stałe o średnicy powyżej 2,5mm Tools, a wire etc. with the diameter or the wire gauge exceeding 2,5mm. Solids with the diameter above 2,5mm
4		Ochrona przed ciałami stałymi przekraczającymi 1mm Protection against solids bigger than 1mm	Drut lub taśma o grubości 1mm. Ciała stałe o średnicy przekraczającej 1mm A wire or a strip 1mm thick. Solids with the diameter above 1mm
5		Pyłoodporność Dust resistance	Niewielka ilość pyłu przedostaje się do wnętrza osłony, lecz jest tak mała, że nie wywiera ujemnego wpływu na pracę wyposażenia Small amount of dust penetrates the shield interior but it is so small that it does not exert a negative influence on the equipment operation
6		Pyłoszczelność Dust-proofing	Pył nie przedostaje się do wnętrza osłony Dust does not penetrate the shield interior

Stopień zabezpieczenia przed wilgocią
Degree of protection against moisture

IP	Rysunek / Picture	Opis / Description	Wyjaśnienie / Explanation
0		Brak ochrony No protection	Brak specjalnych środków ochrony No special protection measures
1		Ochrona przed pionowo wpadającymi kroplami wody Protection against vertically falling water drops	Padające pionowo krople wody nie mogą wywołać szkodliwych skutków w urządzeniu Vertically falling water drops cannot cause detrimental effects within the equipment
2		Ochrona przed kroplami wody przy przechyleniu do 15° Protection against water drops at up to 15-degree angle of deflection	Padające pionowo krople wody nie mogą wywołać szkodliwych skutków przy przechyleniu osłony do 15° względem położenia normalnego Vertically falling water drops cannot cause detrimental effects within the equipment when the shield is tilted up to 15 degrees from its normal position
3		Ochrona przed rozpyloną wodą Protection against sprayed water	Rozpylona woda padająca pod kątem 60° od pionu nie powinna wywołać szkodliwych efektów Sprayed water falling at a 60-degree angle of deflection from the vertical should not cause detrimental effects
4		Ochrona przed bryzgami wody Protection against water splashes	Woda rozbrzgiwana na osłonę z dowolnego kierunku nie powinna wywołać szkodliwych skutków Water splashed onto the shield from any direction should not cause detrimental effects
5		Ochrona przed strugami wody Protection against water streams	Woda z dyszy skierowana na obudowę z dowolnego kierunku nie powinna wywołać szkodliwych skutków Water from a nozzle directed onto the casing from any direction should not cause detrimental effects
6		Ochrona przed falami Protection against waves	Woda po zalaniu falą lub od silnej strugi nie może dostać się do wnętrza osłony w takiej ilości, aby wywołać szkodliwe skutki A flooding water wave or a strong stream cannot penetrate the shield in the amount causing detrimental effects
7		Ochrona przed zanurzeniem Protection against immersion	Przy zanurzeniu urządzenia do wody na określony czas i przy określonym ciśnieniu, woda nie może dostać się do wnętrza osłony w takiej ilości, aby wywołać szkodliwe skutki When the equipment is immersed in water for the predetermined time and at the predetermined pressure, water cannot penetrate the shield in the amount causing detrimental effects
8		Ochrona przed głębokim zanurzeniem Protection against deep immersion	Urządzenie dostosowane do długotrwałego zanurzenia w wodzie w warunkach określonych przez wytwórcę The equipment adapted to long-lasting immersion in water in the conditions specified by the manufacturer

STOSOWANE IKONKI USED SYMBOLS



Klasa bezpieczeństwa Safety class	Symbol Symbol	Wyjaśnienie Explanation
0	Brak None	Ochronę przed porażeniem elektrycznym stanowi izolacja podstawowa. W przypadku uszkodzenia izolacji ochronę przeciwporażeniową powinny zapewnić odpowiednio korzystne warunki środowiskowe oraz położenie urządzenia poza dotykiem bezpośrednim. Protection against electrical shock is guaranteed by the basic isolation. In case that the isolation is damaged, the anti-shock protection should be guaranteed by the appropriately favourable environmental conditions and the equipment location beyond the direct touch.
I		W urządzeniach z I klasą ochronności bezpieczeństwo zapewnione jest poprzez połączenie wszystkich czynnych przewodzących elementów z przewodem ochronnym lub bezpośrednio z uziemieniem. In the equipment of the I class protection the safety is guaranteed through connection of all active conducting elements with a protective conductor or directly with the grounding.
II		W urządzeniach z II klasą ochronności bezpieczeństwo zapewnione jest przez zastosowanie izolacji podwójnej lub wzmocnionej, której w danych warunkach środowiskowych i przy napięciu znamionowym uważa się za nie do przebicia. In the equipment of the II class protection the safety is guaranteed through the application of double or reinforced isolation, which in the given environmental conditions and at the rated voltage is considered unbreakable.
III		Ochrona przeciwporażeniowa w urządzeniach III klasy ochronności jest zapewniona przez obniżenie napięcia zasilania do wartości bezpiecznej w danych warunkach środowiskowych. The anti-shock protection in the III class equipment is guaranteed through decreasing of the supply voltage to the value which is safe in the given environmental conditions.

Temperatura barwowa Tc [K] to temperatura ciała doskonale czarnego, w której wysyła ono promieniowanie świetlne o tej samej barwie co źródło rozpatrywane. Jest to więc to obiektyw-
na miara wrażenia barwy danego źródła światła

Colour temperature Tc [K] is the temperature of a perfect radiator at which it sends visible radiation of the same colour as the colour of the examined source. This is hence an objective
measure of the colour impression of the given source of light

<2700K	Barwa żółto-biała	Yellow-white colour
2700-3300K	Barwa ciepłobiała	Warm white colour
3300-5300K	Barwa neutralna (biała)	Neutral colour (white)
>5300K	Barwa dzienna (chłodnobiała)	Daylight colour (cool white)



Trzonek to część lampy służąca do jej umocowania w oprawce, zwykle również do jej połączenia z obwodem zasilającym. Rodzaj trzonka i odpowiadającej mu oprawki zazwyczaj opisywany jest jedną lub paroma literami oraz liczbą wskazującą przybliżony wymiar trzonka w milimetrach (przeważnie średnicę lub rozstaw bolców). The cap is a part of the lamp that is used for fastening it in a socket, and usually for connecting it to a power supply system. The cap types and their corresponding sockets are usually marked with one or more letters and a number indicating the approximate cap size in millimeters (usually a diameter or a pin spacing).

Prezentujemy najczęściej spotykane rodzaje trzoneków:
The most common cap types are:

trzonki gwintowane / screw caps							
E40	E27	E14					
trzonki do lamp niskonapięciowych / caps for low-voltage lamps							
GY6.35	Gx5,3	G4	G53	GU4	Gx4		
trzonki dwubolcowe / 2-pin caps							
G24d	G23	G9	GU10	GZ10	GR8	G12	GX53
trzonki czterebolcowe / 4-pin caps							
G24q	GR10q	G10q	2G11				
trzonki do lamp dwukońców / double-ended lamp caps							
R7s	Rx-7s	G5	G13				

STOSOWANE IKONKI USED SYMBOLS



27395	kod Kanlux / Kanlux code		jednolitość barw [SDCM] / color uniformity [SDCM]		cos φ	współczynnik mocy / power factor
5902052559695	kod EAN / EAN code			mm		długość / length
	kolor / colour		strumień świetlny / luminous flux	UGR		UGR / UGR
[V]	napięcie znamionowe / rated voltage		nominalny użyteczny strumień świetlny / nominal useful luminous flux			oprawa ruchoma w zakresie horizontalnym / horizontally movable fitting
	zasilanie świetlówek T8 LED jednostronne/ the range of humidity to which the product is adapted		współczynnik oddawania barw Ra / color rendering index Ra			oprawa ruchoma w zakresie wertykalnym / vertically movable fitting
	moc / power		zakres temperatury otoczenia do jakiej przystosowany jest produkt / ambient temperature range to which the product is adapted			oprawa stała / stationary fitting
			zakres wilgotności powietrza do jakiej przystosowany jest produkt / the range of humidity to which the product is adapted			regulacja kątowa oprawy oświetleniowej [°] / angle adjustment of the lighting fixture [°]
[Hz]	częstotliwość znamionowa / rated frequency		kąt rozsyłu światłości / light beam angle			regulacja kątowa oprawy oświetleniowej w dwóch osiach / angle adjustment of the lighting fixture in two axes
PRI [V]	napięcie wejściowe / input voltage		trwałość / durability			regulacja kątowa oprawy oświetleniowej w jednej osi / angle adjustment of the lighting fixture in one axis
SEC [V]	napięcie wyjściowe / output voltage		klasa efektywności energetycznej (Ei) / energy efficiency class (Ei)			otwór montażowy / mounting hole
SEC [mA]	prąd wyjściowy / output current		nie stosować w obwodach z urządzeniami elektronicznymi (np.: ze ściemniaczem) / do not use in circuits with electronic de- vices (e.g. dimmer)			rodzaj statecznika: elektroniczny / ballast type: electronic
	prąd znamionowy / rated current		możliwość współpracy ze ściemniaczem / the possibility of cooperation with a dimmer			rodzaj statecznika: indukcyjny / ballast type: inductive
[In[A] In [mA] In [AX]			możliwość współpracy ze ściemniaczem 1-10V / possibility of cooperation with 1-10V dimmer			rodzaj zasilania - stałonapięciowy / type of power supply - constant voltage
kWh/1000h	roczne zużycie energii / annual energy consumption		możliwość współpracy ze ściemniaczem DALI / possibility of cooperation with DALI dimmer			rodzaj zasilania - stałoprądowy / type of power supply - constant current
	ilość cykli włącz/wyłącz / number on/of switch cycles		wyposażone we włącznik / equipped with a switch			stopień odporności na wnikanie ciał stałych i wilgoci (IP) / solids and humidity penetration protection degree (IP)
	deklaracja równoważności dotycząca mocy / declaration of equivalence regarding power		wyposażony w higrometr / equipped with a hygrometer			stopień określający ochronę przed uderze- niami mechanicznymi / degree of protection against mechanical impacts
	niewymienne źródło światła / non-replaceable light source		wyposażony w włącznik czasowy / equipped with a timer			do zastosowania wewnątrz / for indoor use
	wymienne źródło światła / replaceable light source		wyposażony w włącznik pociągany / equipped with a pull switch			do zastosowania wewnątrz lub na zewnątrz / for indoor or outdoor use
	temperatura barwowa (Tc)/ colour temperature (Tc)		brak rtęci / no mercury			zgodność z normami europejskimi (CE) / compliance with European standards (CE)
	barwa światła / colour temperature		zawartość rtęci / mercury content			certifikat Zgodności potwierdzający jakość produkcji z zatwierdzonymi standardami na terytorium Unii Celnej / certificate of Conformity confirming the quality of production in accordance with approved standards on the territory of the Customs Union
lm W	skuteczność świetlna / luminous efficiency		minimalna odległość od oświetlanego obiektu / the minimum distance from the illuminated object			EAC

STOSOWANE IKONKI USED SYMBOLS



	klasa ochronności przed porażeniem elektrycznym I / class of protection against electric shock I	rodzaj diody / LED type						do nacobudowania na suficie, ścianie lub podłożu / ceiling-, wall- or foundation- mounted
	klasa ochronności przed porażeniem elektrycznym II / class of protection against electric shock II		FILAMENT	MCOB	SMD	COB		na szynie TH35 / rail TH35
	klasa ochronności przed porażeniem elektrycznym II/III / class of protection against electric shock II/III	kierunek świecenia / lighting direction						na szynie TEAR / rail TEAR
	klasa ochronności przed porażeniem elektrycznym III / class of protection against electric shock III							do zawieszania na suficie / for hanging on the ceiling
	lampa nie jest przeznaczona do oświetlenia akcentowego / the lamp is not designed for accent lighting	rodzaj przyłącza / type of connection						rodzaj czujnika / type of sensor
	lampa jest przeznaczona do oświetlenia akcentowego / the lamp is designed for accent lighting	kostka śrubowa / screw cube						micro wave
	możliwość montażu na powierzchniach normalnie palnych / can be mounted on normally flammable surfaces	kostka przyłączeniowa / connection block						2 x PIR
	źródło światła w komplecie / light source included	kostka samozaciskowa / self-locking cube						3 x PIR
	baterie nadajnika / Transmitter batteries	przewód zakończony wtyczką / cable with a plug						charakterystyka wyzwalania / trigger characteristics
	sterowanie: RF 2,4 GHz / control: RF 2,4 GHz	wolne końce przewodów / free cable ends						czas działania czujnika / sensor operation time
	przewód zakończony wtyczką - DC / cable terminated with a plug - DC	średnica przewodu / wire diameter						kąt działania czujnika / sensor operating angle
	typ źródła światła / light source type	długość przewodu / cable length						zasięg czujnika / sensor range
		zakres przekrojów stosowanych przewodów / range of cross-sections of cables used						nastawa poziomu natężenia oświetlenia, przy którym czujnik wykrywa ruch / setting the brightness level at which the sensor detects movement
		długość przewodu zasilacza zakończony wtyczką / length of the power cord terminated with a plug						głośność / loudness
		montaż / assembly						objętościowy przepływ powietrza [m3/h] / the volumetric air flow [m3/h]
		do nacobudowania na ścianie / wall-mounted						obroty silnika / engine speed
		do wbudowania w ścianę / wall recessed						ilość biegunów / number of poles
		do nacobudowania na suficie / ceiling-mounted						liczba modułów / number of modules
		do wbudowania w sufit / ceiling recessed						
		do nacobudowania w suficie lub ścianę / ceiling or wall recessed						
		do nacobudowania na podłożu / foundation-mounted						
		do wbudowania w podłoże / foundation recessed						
	trzonek / cap							

INDEKS ALFABETYCZNY

ALPHABETICAL INDEX

ADAMO MTH-400/A	04846	291	APUS LED CW	23107	210
ADAMO MTH-400/S	04842	291	APUS LED PIR B-NW	29856	210
ADI 350 1x3W	01440	344	APUS LED PIR B-WW	29857	210
ADTR 12030 B	27614	239, 241	APUS LED PIR CW	27371	210
ADTR 12030 SR	27612	239, 241	APUS LED PIR WW	27370	210
ADTR 12030 W	27611	239, 241	APUS LED W-CW	26841	210
ADTR 3060 B	29842	239	APUS LED WW	23106	210
ADTR 3060 SR	29841	239	APUS LED W-WW	26840	210
ADTR 3060 W	29840	239	AR-111 LED SL/NW/SR	22968	79
ADTR 6060 B	27615	239, 241	AR-111 LED SL/WW/SR	22962	79
ADTR 6060 SR	27610	239, 241	AR-111 LED SL/WW/W	22960	79
ADTR 6060 W	27613	239, 241	ARDEA 1030 1/2/ML-BI	70788	143
ADTR-H 6060 B	29845	237	ARDEA 1030 M/ML-BI	70786	143
ADTR-H 6060 SR	29844	237	ARDEA 1030 S/ML-BI	70784	143
ADTR-H 6060 W	29843	237	ARDEA 1030 SG/ML-SR	70761	143
AJAS DSO-B	33160	161	ARDEA 1130 D/ML-BI	70782	143
AJAS DSO-W	33161	161	AREL LED DL 10W-NW	29586	280
AKVEN LED	25720	321	AREL LED DL 10W-WW	29587	280
ALDO 4LED 1X120	26361	258	AREL LED DL 14W-NW	29590	280
ALDO 4LED 1X150	26362	258	AREL LED DL 14W-WW	29591	280
ALDO 4LED 1X60	26360	258	AREL LED DL 20W-NW	29594	280
ALDO 4LED 2X120	26364	258	AREL LED DL 20W-WW	29595	280
ALDO 4LED 2X150	26365	258	AREL LED DL 25W-NW	29598	280
ALER JQ-30-B	00461	334	AREL LED DL 25W-WW	29599	280
ALER JQ-30-W	00460	334	AREL LED DL 6W-NW	29582	280
ALER MINI-W	23450	334	AREL LED DL 6W-WW	29583	280
ALGO GU10 CL-B	27030	138	AREL LED DO 10W-NW	29584	280
ALGO GU10 CL-W	27032	138	AREL LED DO 10W-WW	29585	280
ALGO GU10 CO-B	27033	138	AREL LED DO 14W-NW	29588	280
ALGO GU10 CO-W	27035	138	AREL LED DO 14W-WW	29589	280
ALGO GU10 PL-B	27036	123	AREL LED DO 20W-NW	29592	280
ALGO GU10 PO-B	27039	123	AREL LED DO 20W-WW	29593	280
ALIN 4 LED	xxx	30-31	AREL LED DO 25W-NW	29596	280
ALIN LED	xxx	18-23	AREL LED DO 25W-WW	29597	280
ALIN LED LINE	xxx	24-29	AREL LED DO 6W-NW	29580	280
ALOR DSL-B	26727	196	AREL LED DO 6W-WW	29581	280
ALOR DSL-C	26728	196	ARET 1XMR16-GR	26721	179
ALOR DSL-C/M	26729	196	ARET 1XMR16-W	26720	179
ALOR DSL-W	26726	196	ARET 2XMR16-W	26723	179
ALOR DSO-B	26791	196	ARGUS CT-2114-AN	00327	194
ALOR DTL-B	26732	196	ARGUS CT-2114-BR/M	00324	194
ALOR DTO-B	26796	196	ARGUS CT-2114-C	00301	194
ALREN DTL-B	26754	181	ARGUS CT-2114-C/M	00325	194
ALREN DTL-C	26755	181	ARGUS CT-2114-G	00300	194
ALREN DTL-C/M	26756	181	ARGUS CT-2114-GM	00328	194
ALREN DTL-W	26753	181	ARGUS CT-2114-W	00303	194
ALREN R DTL-B	26757	180	ARGUS CT-2115-AN	00333	194
ALREN R DTL-W	26758	180	ARGUS CT-2115-BR/M	00330	194
ANTEM LED 100W-NW B	33204	288	ARGUS CT-2115-C	00305	194
ANTEM LED 10W-NW B	33200	288	ARGUS CT-2115-C/M	00331	194
ANTEM LED 10W-NW-SE B	33205	288	ARGUS CT-2115-G	00304	194
ANTEM LED 20W-NW B	33201	288	ARGUS CT-2115-GM	00334	194
ANTEM LED 20W-NW-SE B	33206	288	ARGUS CT-2115-W	00307	194
ANTEM LED 30W-NW B	33202	288	ARGUS CT-2117-BR/M	00336	194
ANTEM LED 30W-NW-SE B	33207	288	ARGUS CT-2117-C	00309	194
ANTEM LED 50W-NW B	33203	288	ARGUS CT-2117-C/M	00337	194
ANTEM LED 50W-NW-SE B	33208	288	ARGUS CT-2117-GM	00340	194
ANTOS LED 10W-NW B	27090	289	ARGUS CT-2117-W	00311	194
ANTOS LED 10W-NW-SE B	27094	289	ARTO 3L-SR	26616	278
ANTOS LED 20W-NW B	27091	289	ASIL G9 W-B	27020	204
ANTOS LED 20W-NW-SE B	27095	289	ASIL G9 W-GR	27021	204
ANTOS LED 30W-NW B	27092	289	ASIL G9 W-W	27022	204
ANTOS LED 30W-NW-SE B	27096	289	ASTEN IP44 12W-NW-B	26684	206
ANTOS LED 50W-NW B	27093	289	ASTEN IP44 8W-NW-B	26683	206
ANTOS LED 50W-NW-SE B	27097	289	ASTEN LED IP44 12W-NW	26681	206
APO TM-3	07980	357	ASTEN LED IP44 15W-NW	26682	206
APRILA DTL-W	26739	176	ASTEN LED IP44 8W-NW	26680	206
APRILA DTO-W	26738	176	ATL1 18W-930-S6-B	33131	326
APUS LED AC B-NW	26536	210	ATL1 18W-930-S6-W	33130	326
APUS LED AC B-WW	26537	210	ATL1 18W-940-S6-B	33133	326
APUS LED AC-CW	23801	210	ATL1 18W-940-S6-W	33132	326
APUS LED AC-WW	23800	210	ATL1 30W-930-S6-B	33135	326
APUS LED B-NW	26538	210	ATL1 30W-930-S6-W	33134	326
APUS LED B-WW	26539	210	ATL1 30W-940-S6-B	33137	326

ATL1 30W-940-S6-W	33136	326	BORD DLP-250-AL.	22553	132
ATL2 GU10-B	33139	328	BORD DLP-250-B	22555	132
ATL2 GU10-W	33138	328	BORD DLP-250-W	22554	132
AVAR 6060 40W-CW	26771	243	BORD DLP-350-AL.	25802	132
AVAR 6060 40W-NW	26770	243	BORD DLP-350-W	25800	132
AVAR 6060 40W-WW	26772	243	BORD DLP-50-AL.	22550	132
AVAR 6262 40W-NW	26773	243	BORD DLP-50-B	22552	132
AVAR 6262 40W-WW	26774	243	BORD DLP-50-W	22551	132
AVAR DALI SET 40W	28512	243	BRASO LED 28W 6060 NW	32620	242
AVIA MTH-478/400W-B	04011	291	BRAVO DALI SET 36W	28508	239
AWAN LED C-W	26491	226	BRAVO DALI SET 45W	28507	239
AWAN LED S-W	26490	226	BRAVO DRIVER 28W	28029	239
AZ-10A	22371	342	BRAVO DRIVER 36W	28025	239
BART EL-235	07080	298	BRAVO DRIVER 40W	28026	241
BART EL-260	07082	298	BRAVO DRIVER 45W	28027	239
BASK CTC-5514-MPC/N	02814	197	BRAVO DRIVER 50W	28028	241
BASK CTC-5514-SN/N	02816	197	BRAVO P 36W12030NW W	28020	238
BASK CTC-5515-MPC/N	02804	197	BRAVO P 36W6060CW W	28006	238
BASK CTC-5515-SN/N	02806	197	BRAVO P 36W6060NW W	28000	238
BENO 18W NW-L-GR	32943	260	BRAVO P 45W6060NW W	28008	238
BENO 18W NW-L-SE GR	32947	260	BRAVO PU28W3060NW W	28551	238
BENO 18W NW-L-SE W	32946	260	BRAVO PU36W6060NW SR	28003	238
BENO 18W NW-L-W	32942	260	BRAVO PU36W6060NW W	28002	238
BENO 18W NW-O-GR	32941	260	BRAVO PU36W6262NW W	28024	238
BENO 18W NW-O-SE GR	32945	260	BRAVO S 40W12030NW W	28022	240
BENO 18W NW-O-SE W	32944	260	BRAVO S 40W6060NW SR	28011	240
BENO 18W NW-O-W	32940	260	BRAVO S 40W6060NW W	28010	240
BENO 24W NW-L-GR	33343	260	BRAVO S 50W6060NW SR	28019	240
BENO 24W NW-L-SE GR	33347	260	BRAVO S 50W6060NW W	28018	240
BENO 24W NW-L-SE W	32946	260	BRAVO S/P GRIP 12030	28501	239, 241
BENO 24W NW-L-W	33342	260	BRAVO S/P GRIP 60-62	28500	239, 241
BENO 24W NW-O-GR	33341	260	BRAVO SU40W6060NW SR	28013	240
BENO 24W NW-O-SE GR	33345	260	BR-GZ10	72369	358
BENO 24W NW-O-SE W	33344	260	BS-1 4-22W	07180	348
BENO 24W NW-O-W	33340	260	BS-2 4-65W	07181	348
BERG DL-35L	07171	309	CANTA CTX-DS20	19610	199
BERG DL-35O	07170	309	CARSA V2LED 12W-NW-SN	27210	285
BIGGE LED 42W-NW-L	28723	266	CARSA V2LED 12W-NW-W	28948	285
BIGGE LED 42W-NW-O	28721	266	CARSA V2LED 18W-NW-SN	27211	285
BILO 3W T SMD E14-WW	23040	67	CARSA V2LED 18W-NW-W	28949	285
BILO 3W T SMD E27-WW	23041	67	CEL CTC-5519-C/M	02755	178
BILO 5W T SMD E14-WW	23042	67	CEMIN DTL-GR	27230	178
BILO 5W T SMD E27-WW	23043	67	CHIRO GU10 DTL-B	29313	164
BILO 6,5W T SMDE14-NW	23423	67	CHIRO GU10 DTL-W	29312	164
BILO 6,5W T SMDE14-WW	23422	67	CHIRO GU10 DTO-B	29311	164
BILO 6,5W T SMDE27-NW	23421	67	CHIRO GU10 DTO-W	29310	164
BILO 6,5W T SMDE27-WW	23420	67	CIRCO LED 12VDC 0-10W	24240	345
BILO HI 8W E14-NW	26763	68	CIRCO LED 12VDC 0-15W	24241	345
BILO HI 8W E14-WW	26762	68	CLIPS BLINGO RT	29826	237
BILO HI 8W E27-NW	26765	68	CLIPS BRAVO S/P 12030	28503	239, 241
BILO HI 8W E27-WW	26764	68	CLIPS BRAVO S/P 60-62	28502	239, 241
BISO LED EL 8W-GR	29260	302	CL-MAH PLUS	18593	256
BISO LED EL 8W-W	29261	302	CL-MAH PLUS-INOX	18594	256
BL-118H-EVG	70480	348	CLP-REGIS\PT	72333	245
BL-136H-EVG	70481	348	COLIE DTO-AL.	26742	182
BL-158H-EVG	70482	348	COLIE DTO-B	26743	182
BL-218H-EVG	70483	348	COLIE DTO-G	26741	182
BL-236H-EVG	70484	348	COLIE DTO-GR	26744	182
BL-258H-EVG	70485	348	COLIE DTO-W	26740	182
BL-3-4x14H-EVG	08240	348	CONNECT C/D/E/I	26563	102, 103, 104, 108
BL-418H-EVG	70486	348	CONNECT-L B	26604	101
BLINGO P 38W 6060 NW	33180	236	CONNECT-L C	26562	102
BLINGO R 38W 12030 NW	29823	236	CONNECTOR RGB 10	19038	94
BLINGO R 38W 6060 NW	29822	236	CONNECTOR RGB 10-CP	19036	94
BLINGO RU 38W 6060 NW	29824	236	CONNECTOR RGB 10-CPC	19037	94
BLINGO TU 48W 6060 NW	29825	236	CONTROLLER LED RGB-RF	22140	94
BLURRO 2xGU10 CO-B	32952	130	CONTROLLER RGB-IR20	18960	94
BLURRO 2xGU10 CO-W	32953	130	CROTO LED-GR-L	22770	304
BLURRO GU10 CO-B	32950	130	CT-2116B-BR/M GAVI	00814	220
BLURRO GU10 CO-W	32951	130	CT-2116B-C GAVI	00811	220
BONIS DSL-C	28703	167	CT-2116B-C/M GAVI	00815	220
BONIS DSL-W	28702	167	CT-2116B-W GAVI	00810	220
BONIS DSO-C	28701	167	CTRL 12\24V 10A CCT	22142	97
BONIS DSO-W	28700	167	CTRL 12\24V 10A MONO	22141	97

INDEKS ALFABETYCZNY

ALPHABETICAL INDEX

CTRL 12/24V 10A RGBW	22143	99	ENALI EL-30 B	28765	148
CYBER TM-6	01016	343	ENALI EL-30 W	28764	148
CYDEA D	25551	233	ENALI EL-41 B	28769	148
CYKLON EOL100	70910	351	ENALI EL-41 W	28768	148
CYKLON EOL100B	70911	351	ERINUS LED L B-NW	33333	208
CYKLON EOL100HT	70936	351	ERINUS LED L B-WW	33332	208
CYKLON EOL100P	70937	351	ERINUS LED L GR-NW	33327	208
CYKLON EOL100T	70938	351	ERINUS LED L GR-WW	33326	208
CYKLON EOL120	70915	351	ERINUS LED L W-NW	33321	208
CYKLON EOL120B	70916	351	ERINUS LED L W-WW	33320	208
CYKLON EOL120HT	70941	351	ERINUS LED LL B-NW	33337	208
CYKLON EOL120P	70942	351	ERINUS LED LL B-WW	33336	208
CYKLON EOL120T	70943	351	ERINUS LED LL GR-NW	33331	208
CYKLON EOL150	70920	351	ERINUS LED LL GR-WW	33330	208
CYKLON EOL150B	70921	351	ERINUS LED LL W-NW	33325	208
CYKLON EOL150P	70947	351	ERINUS LED LL W-WW	33324	208
CYKLON EOL150T	70948	351	ERINUS LED O B-NW	33335	208
DABA N LED SMD DL-16W	19062	265	ERINUS LED O B-WW	33334	208
DABA N LED SMD DL-22W	19063	265	ERINUS LED O GR-NW	33329	208
DAIBO LED T-B	33220	232	ERINUS LED O GR-WW	33328	208
DAIBO LED T-W	33221	232	ERINUS LED O W-NW	33323	208
DALLA CT-DTL50-B	22433	172	ERINUS LED O W-WW	33322	208
DALLA CT-DTL50-W	22431	172	ES-111 LED SL/NW/SR	22978	80
DALLA CT-DTO50-B	22432	172	ES-111 LED SL/WW/SR	22972	80
DALLA CT-DTO50-W	22430	172	ES-111 LED SL/WW/W	22970	80
DARSA EL-135L-UP	19120	299	ESG LED 9W GX53-CW	22424	86
DARSA EL-235T-UP	19121	299	ESG LED 9W GX53-NW	22423	86
DB-FF6 12/24VDC	23572	222	ESG LED 9W GX53-WW	22422	86
DD-16W/4P 3500K	12660	116	ETISSA D20 GR	27000	122
DD-21W/4P 3500K	12661	116	EVELI EL-10	29100	152
DD-28W/4P 3500K	12662	116	EVELI EL-2I	29101	152
DD-38W/4P 3500K	12663	116	EVELI EL-30	29102	152
DIM-FF1 12/24VDC	23571	222	EVELI EL-4I	29103	152
DimGO 105	28830	347	EVIT CT-DTL50-AL.	18560	184
DINO CTX-DS02G/B-C	02576	200	EVIT CT-DTO50-AL.	18561	184
DIVISO W 3	26091	355	FL MASTER LED 100W-NW	28490	286
DORA LED-J01	04680	305	FL MASTER LED 140W-NW	28491	286
DOSAN LED B	26691	223	FL MASTER LED 220W-NW	28492	286
DOSAN LED W	26690	223	FLINI IP44 DSL-B	33120	190
DRIFT LED 0-6W	18040	344	FLINI IP44 DSL-W	33121	190
DRIFT LED 3-18W	08550	344	FLINI IP44 DSO-B	33122	190
DRIFT LED F 0-18W	18042	222	FLINI IP44 DSO-W	33123	190
DROMI LED 50 7W-GR	32532	315	FLM LED 100W-NW-60D	28520	287
DROMI LED 80 7W-GR	32533	315	FLM LED 140W-NW-60D	28522	287
DROMI LED EL-1 7W-GR	32530	315	FLM LED 220W-NW-60D	28524	287
DROMI LED EL-2 13W-GR	32531	315	FLM LED100W-NW110/150	28521	287
DUCE AL-DTL50	19950	139	FLM LED140W-NW110/150	28523	287
DUCE AL-DTO50	19951	139	FLM LED220W-NW110/150	28525	287
DUN 4,5W T SMD E14-NW	23381	61	FOGLER DL-2400	18120	268
DUN 4,5W T SMD E14-WW	23380	61	FOGLER LED 14W-NW	18121	267
DUN 6,5W T SMD E14-NW	23431	61	FOLLO LED B	28791	228
DUN 6,5W T SMD E14-WW	23430	61	FOLLO LED W	28790	228
DUN HI 8W E14-NW	26761	62	FORRO LED EL 8W-GR	29250	302
DUN HI 8W E14-WW	26760	62	FORRO LED EL 8W-W	29251	302
ELNIS L A	27809	169	FRANCO 15LED SMD KT-B	22341	228
ELNIS L A/C	27808	169	FRANCO 15LED SMD KT-W	22340	228
ELNIS L C/A	27812	169	FULLED GU10-3,3W-CW	26035	72
ELNIS L A/W	27807	169	FULLED GU10-3,3W-NW	26034	72
ELNIS L B/G	27810	169	FULLED GU10-3,3W-WW	26033	72
ELNIS L C/W	27811	169	FUTURIO LED	xxx	38-41
ELNIS L W	27804	169	G9 GLASS LED2W-CW	26631	75
ELNIS L W/A	27805	169	G9 GLASS LED2W-WW	26630	75
ELNIS L W/C	27806	169	G9-20W STAR	18420	112
ELNIS S A/C	27803	168	G9-33W STAR	18421	112
ELNIS S A/W	27802	168	G9-48W STAR	18422	112
ELNIS S W	27800	168	G9-60W STAR	18423	112
ELNIS S W/A	27801	168	GARTO LED EL 8W-GR	29270	303
ENALI EL-10 B	28761	148	GARTO LED EL 8W-W	29271	303
ENALI EL-10 W	28760	148	GAVI LED18 SMD-WW-C/M	19761	219
ENALI EL-21 B	28763	148	GIO LED G4 FL-NW	22663	77
ENALI EL-21 W	28762	148	GIO LED G4 FL-WW	22662	77
ENALI EL-31 B	28767	148	GIO LED G9-NW	22661	75
ENALI EL-31 W	28766	148	GIO LED G9-WW	22660	75

INDEKS ALFABETYCZNY

ALPHABETICAL INDEX

GIVRO LED-BL 50M	08631	111	HBPB GRID 150W	33197	295
GIVRO LED-CW 50M	08630	111	HBPB GRID 200W	33198	295
GIVRO LED-GN 50M	08633	111	HBPB LENS 120D 100W	33193	295
GIVRO LED-RE 50M	08632	111	HBPB LENS 120D 150W	33194	295
GIVRO LED-WW 50M	08642	111	HBPB LENS 120D 200W	33195	295
GIVRO LED-Y 50M	08634	111	HBPB LENS 60D 100W	33190	295
GIVRO PR SET	08637	111	HBPB LENS 60D 150W	33191	295
GIVRO-90L	08636	111	HBPB LENS 60D 200W	33192	295
GIVRO-I	08639	111	HERMI 7063NB	70524	272
GIVRO-PEND	08640	111	HERON LED B	27600	231
GIVRO-T	08641	111	HERON LED W	27601	231
GIVRO-X	08635	111	HLDR-E14	02170	358
GIVRO-Z	08638	111	HLDR-E14\GU10	08851	361
GLASO EL-10	19640	153	HLDR-E14-F	02173	358
GLASO EL-2I	19641	153	HLDR-E27	02160	359
GLASO EL-3I	19642	153	HLDR-E27\GU10	08850	361
GLASO EL-3O	19644	153	HLDR-E27-D	02162	359
GL-IDAVA PS LS 25	23513	322	HLDR-E27-F	02161	359
GL-IDAVA PS LS 47	23515	322	HLDR-G9	08220	360
GLASO EL-4I	19643	153	HLDR-GX5,3	72109	360
GL-MAH-136 PLUS-PC	18589	256	HLDR-GZ10	00402	360
GL-MAH-158 PLUS-PC	18596	256	HLDR-R7S	00405	361
GL-MAH-218 PLUS-PC	18587	256	HORN CTC-3114-GM/N	02824	198
GORD DLP 250-B	25474	134	HORN CTC-3114-PG/N	02823	198
GORD DLP 250-W	25473	134	HORN CTC-3114-SN/G	02820	198
GORD DLP 50-AL	25472	134	HORN CTC-3114-SN/N	02821	198
GORD DLP 50-B	25471	134	HORN CTC-3115-GM/N	02834	198
GORD DLP 50-W	25470	134	HORN CTC-3115-SN/G	02830	198
GORDO LED14 SMD-L	22051	309	HORN CTC-3115-SN/N	02831	198
GORDO LED14 SMD-O	22050	309	IDAVA 25	23510	322
GORI 50	29002	317	IDAVA 35	23511	322
GORI 80	29003	317	IDAVA 47	23512	322
GORI EL 135 D	29000	317	IDO 4,5W T SMD E14-NW	23383	63
GORI EL 235 D	29001	317	IDO 4,5W T SMD E14-WW	23382	63
GOVIK DSO-B	29236	160	IDO 6,5W T SMD E14-NW	23491	63
GOVIK DSO-W	29235	160	IDO 6,5W T SMD E14-WW	23490	63
GOVIK-ST DSO-B	29237	160	IMBER LED CW	23521	201
GOVIK-ST DSO-W	29238	160	IMBER LED NW	23520	201
GP-2	70513	355	IMINES DSL-W	29030	166
GRIBLO LED SMD-NW	18131	321	IMINES DSO-W	29031	166
GRIP GP'S	04862	355	INES 7061N	70525	271
GRIP W\US	04863	355	INVO OP 107-L-GR	29173	312
GWEN CT-DTL50-B	18530	184	INVO OP 47-L-GR	29171	312
GWEN CT-DTO50-B	18531	184	INVO OP 77-L-GR	29172	312
HANDLE A	19190	100	INVO OP EL-53-L-GR	29170	312
HANDLE B/F	26596	101, 105	INVO TR 107-O-GR	29177	313
HANDLE C/D/E/I	26597	102, 103, 104, 108	INVO TR 47-O-GR	29175	313
HANDLE G	26598	106	INVO TR 77-O-GR	29176	313
HANDLE H	26599	107	INVO TR EL-53-O-GR	29174	313
HANDLE J/K	26595	109, 110	IQ-LED A60 10,5W-CW	27278	46
HANDLE SIDE H	26600	107	IQ-LED A60 10,5W-NW	27277	46
HAXA-DSO POWER LED-B	08103	201	IQ-LED A60 10,5W-WW	27276	46
HB MASTER LED 100W	28530	294	IQ-LED A60 14W-CW	27281	46
HB MASTER LED 150W	28531	294	IQ-LED A60 14W-NW	27280	46
HB MASTER LED 200W	28532	294	IQ-LED A60 14W-WW	27279	46
HB PRO LED HI 100W-NW	27155	296	IQ-LED A60 5,5W-CW	27272	46
HB PRO LED HI 150W-NW	27156	296	IQ-LED A60 5,5W-NW	27271	46
HB PRO LED HI 200W-NW	27157	296	IQ-LED A60 5,5W-WW	27270	46
HBM BRACKET 100/150W	28543	293	IQ-LED A60 9W-CW	27275	46
HBM BRACKET 200W	28544	293	IQ-LED A60 9W-NW	27274	46
HBM GRID 100/150W	28545	293	IQ-LED A60 9W-WW	27273	46
HBM GRID 200W	28546	293	IQ-LED A67 17,5W-CW	27314	47
HBM LENS 60D 100/150W	28537	293	IQ-LED A67 17,5W-NW	27313	47
HBM LENS 60D 200W	28540	293	IQ-LED A67 17,5W-WW	27312	47
HBM LENS 90D 100/150W	28538	293	IQ-LED A67 20W-CW	27317	47
HBM LENS 90D 200W	28541	293	IQ-LED A67 20W-NW	27316	47
HBM PC 100D 100/150W	28539	293	IQ-LED A67 20W-WW	27315	47
HBM PC 100D 200W	28542	293	IQ-LED C37E14 5,5W-CW	27296	58
HBM REF ALU100/150W	28533	293	IQ-LED C37E14 5,5W-NW	27295	58
HBM REF ALU200W	28534	293	IQ-LED C37E14 5,5W-WW	27294	58
HBM REF PC100/150W	28535	293	IQ-LED C37E14 7,5W-CW	27299	58
HBM REF PC200W	28536	293	IQ-LED C37E14 7,5W-NW	27298	58
HBPB GRID 100W	33196	295	IQ-LED C37E14 7,5W-WW	27297	58
			IQ-LED G45E14 5,5W-CW	27302	64

INDEKS ALFABETYCZNY
ALPHABETICAL INDEX

IQ-LED G45E14 5,5W-NW	27301	64	JASMIN 470-W	23125	141
IQ-LED G45E14 5,5W-WW	27300	64	JASMIN 470-W/M	23128	141
IQ-LED G45E14 7,5W-CW	27308	64	JASMIN 470-WE	23122	141
IQ-LED G45E14 7,5W-NW	27307	64	JASMIN 470-W-H	23756	141
IQ-LED G45E14 7,5W-WW	27306	64	JASMIN W/M-W	23758	141
IQ-LED G45E27 5,5W-CW	27305	64	JASMIN WE-W	23756	141
IQ-LED G45E27 5,5W-NW	27304	64	JASMIN W-W	23757	141
IQ-LED G45E27 5,5W-WW	27303	64	JC-10W G4	10722	113
IQ-LED G45E27 7,5W-CW	27311	64	JC-20W G4	10724	113
IQ-LED G45E27 7,5W-NW	27310	64	JC-20W GY6.35	10730	113
IQ-LED G45E27 7,5W-WW	27309	64	JC-35W GY6.35	10732	113
IQ-LED GU10 5W-CW	29805	69	JC-50W GY6.35	10734	113
IQ-LED GU10 5W-NW	29804	69	JC-5W G4	10720	113
IQ-LED GU10 5W-WW	29803	69	JURBA DL-218L	08981	268
IQ-LED GU10 6,5W-CW	29811	69	JURBA DL-218O	08980	268
IQ-LED GU10 6,5W-NW	29810	69	KANTI V2LED 12W-NW-SN	27212	285
IQ-LED GU10 6,5WS3-CW	29808	69	KANTI V2LED 12W-NW-W	28950	285
IQ-LED GU10 6,5WS3-NW	29807	69	KANTI V2LED 18W-NW-SN	27213	285
IQ-LED GU10 6,5WS3-WW	29806	69	KANTI V2LED 18W-NW-W	28951	285
IQ-LED GU10 6,5W-WW	29809	69	KATRO V2LED 12W-NW-SR	28939	283
IQ-LEDDIM A60 15W-CW	27293	48	KATRO V2LED 12W-NW-W	28940	283
IQ-LEDDIM A60 15W-NW	27292	48	KATRO V2LED 12W-WW-W	28941	283
IQ-LEDDIM A60 15W-WW	27291	48	KATRO V2LED 18W-NW-SR	28942	283
IQ-LEDDIM A60 5,5W-CW	27284	48	KATRO V2LED 18W-NW-W	28943	283
IQ-LEDDIM A60 5,5W-NW	27283	48	KATRO V2LED 18W-WW-W	28944	283
IQ-LEDDIM A60 5,5W-WW	27282	48	KATRO V2LED 24W-NW-SN	27216	283
IQ-LEDDIM A60 8,5W-CW	27287	48	KATRO V2LED 24W-NW-W	28945	283
IQ-LEDDIM A60 8,5W-NW	27286	48	KATRO V2LED 6W-NW-SN	27217	283
IQ-LEDDIM A60 8,5W-WW	27285	48	KATRO V2LED 6W-NW-W	28946	283
IQ-LEDDIM A6012,5W-CW	27290	48	KATRO V2LED 6W-WW-W	28947	283
IQ-LEDDIM A6012,5W-NW	27289	48	KIRA DL-75B	07900	270
IQ-LEDDIM A6012,5W-WW	27288	48	KRALA CORD-2M	28275	252
IQ-LEDIM GU10 6,5W-CW	29814	70	KRALA LED 45W NW	28270	252
IQ-LEDIM GU10 6,5W-NW	29813	70	KRALA PLUG-1M	28271	252
IQ-LEDIM GU10 6,5W-WW	29812	70	KRALA PP-0,35M	28274	252
ISTI LED B	27361	226	KRALA PP-1M	28273	252
ISTI LED W	27360	226	KRALA PR-I	28272	252
IT-1\10-B	01257	370	KRALA SENSOR	28276	252
IT-1\20-B	01271	370	L120 16W/M 12 IP00CCT	33317	93
IT-1\20-BL	01275	370	L120 16W/M 24 IP00-CW	33313	91
IT-1\20-GN	01274	370	L120 16W/M 24 IP00-NW	33312	91
IT-1\20-MIX	01283	370	L120 16W/M 24 IP00-WW	33311	91
IT-1\20-RE	01273	370	L120 16W/M 24 IP65-CW	33316	91
IT-1\20-W	01276	370	L120 16W/M 24 IP65-NW	33315	91
IT-1\20-Y	01272	370	L120 16W/M 24 IP65-WW	33314	91
IT-1\20-Y\GN	01277	370	L48 9W\M 24 IP00-RGBW	33318	95
ITECH M2 302 AT	27050	362	L48 9W\M 24 IP65-RGBW	33319	95
ITECH M5 105 M ST W	27381	362	L60 11W/M 12 IP00-CW	33304	90
ITECHF1302MATW	27635	362	L60 11W/M 12 IP00-NW	33303	90
ITECHF2105MATW	27638	362	L60 11W/M 12 IP00-WW	33302	90
ITECHM5105MATW	27622	362	L60 11W/M 12 IP65-CW	33310	90
ITECHM5105MCOLDATW	27623	362	L60 11W/M 12 IP65-NW	33309	90
IVIAN LED 4,5W SN-NW	25783	279	L60 11W/M 12 IP65-WW	33308	90
IVIAN LED 4,5W SN-WW	25781	279	L60B 11W/M 12 IP00-CW	33307	90
IVIAN LED 4,5W W-NW	25782	279	L60B 11W/M 12 IP00-NW	33306	90
IVIAN LED 4,5W W-WW	25780	279	L60B 11W/M 12 IP00-WW	33305	90
IVRI DTO-W	26736	178	LART EL-160-GR	29832	298
J-1000W 189MM	10418	114	LART EL-260-GR	29833	298
J-120W 118MM STAR	08500	114	LAURIN EL-10 B	29121	144
J-120W 78MM STAR	08491	114	LAURIN EL-10 W	29120	144
J-1500W 254MM	10419	114	LAURIN EL-2I B	29123	144
J-160W 118MM STAR	08501	114	LAURIN EL-2I W	29122	144
J-230W 118MM STAR	08502	114	LAURIN EL-3I B	29125	144
J-400W 118MM STAR	08503	114	LAURIN EL-3I W	29124	144
J-80W 78MM STAR	08490	114	LAURIN EL-3O B	29127	144
JASMIN 270-W	23123	141	LAURIN EL-3O W	29126	144
JASMIN 270-W/M	23126	141	LAURIN EL-4O B	29129	144
JASMIN 270-WE	23120	141	LAURIN EL-4O W	29128	144
JASMIN 370-A	29200	141	LCOB 9W/M 12IP00-NW	33301	92
JASMIN 370-W	23124	141	LCOB 9W/M 12IP00-WW	33300	92
JASMIN 370-W/M	23127	141	LED12 G4-NW	18503	78
JASMIN 370-WE	23121	141	LED12 G4-WW	18502	78
JASMIN 470-A	23129	141	LED15 C MR16-CW-B	22204	73

LED15 C MR16-WW-B	22203	73	MATEO DLP-250-GR	04961	277
LEDS SET S-DIM IR	26320	96	MATEO DLP-350-GR	04962	277
LEDS SET S-DIM TS	26321	96	MATEO ES DLP-150-B	32930	276
LEDS SET W-SE BTRY	26323	96	MATEO ES DLP-150-W	32931	276
LEDS-B 4.8W/M IP00-CW	24518	89	MATEO ES DLP-250-B	32932	276
LEDS-B 4.8W/M IP00-NW	24517	89	MATEO ES DLP-250-W	32933	276
LEDS-B 4.8W/M IP00-WW	24516	89	MEBA 4LED 2X120 OP PS	26964	257
LEDS-B 4.8W/M IP54-CW	24512	89	MEBA 4LED 2X120 PS	26961	257
LEDS-B 4.8W/M IP54-NW	24511	89	MEBA 4LED 2X150 OP PS	26965	257
LEDS-B 4.8W/M IP54-WW	24510	89	MEBA 4LED 2X60 OP PS	26963	257
LEDS-B 4.8W/M IP65-CW	24515	89	MEBA 4LED 2X60 PS	26960	257
LEDS-B 4.8W/M IP65-NW	24514	89	MEFIS LED B-NW	32497	215
LEDS-B 4.8W/M IP65-WW	24513	89	MEFIS LED B-WW	32496	215
LEDS-B 7.2W/M IP00RGB	24530	94	MEFIS LED GR-NW	32499	215
LEDS-B 7.2W/M IP54RGB	24532	94	MEFIS LED GR-WW	32498	215
LEDS-B 7.2W/M IP65RGB	24531	94	MEFIS LED W-NW	32495	215
LFD-T02/S-C/M ZEPO	04386	218	MEFIS LED W-WW	32494	215
LFD-T02-C/M ZEPO	04381	218	MERA LED 10W NW	29211	216
LINDA LED-J02	04681	304	MERA LED 15W NW	29212	216
LINUS LED 4W-NW	27590	218	MERA LED 20W NW	29213	216
LINUS LED 7W-NW	27591	218	MERA LED 5W NW	29210	216
LINUS LINK	14977	218	MERA LED PP	29214	216
LITEN LED 6W-NW	25561	279	MERA PP	04733	217
LITEN LED 6W-WW	25560	279	MERA TL-13/2700K	08302	217
LITEN LED 8W-NW	25563	279	MERA TL-13/4000K	04731	217
LITEN LED 8W-WW	25562	279	MERA TL-21/4000K	04732	217
LUNATI GU10 B	29041	131	MERA TL-8/4000K	04730	217
LUNATI GU10 W	29040	131	MERGE ADJ-O	23451	339
LUNGA 3 3G1,0X1,4M	25950	352	MERGE JQ-L	07690	336
LUNGA 3 3G1,0X3M	26500	352	MERGE JQ-O	07691	338
LUNGA 3 3G1,0X5M	26501	352	MERGE MW-L	23453	339
LUNGA 5 3G1,0X5M	26505	352	MERIL DLP-250-W	26481	180
LUNGA S3 3G1,0X1,4M	25954	353	MERIL DLP-50-W	26480	180
LUNGA S3 3G1,0X3M	26508	353	MERSA 300-B/M	29050	140
LUNGA S3 3G1,0X5M	26509	353	MERSA 300-W/M	25675	140
LUNGA S4 3G1,0X3M	26510	353	MERSA 380-B/M	29051	140
LUNGA S5 3G1,0X3M	26512	353	MERSA 380-W/M	25678	140
LUNI PRO E27 LED-WW	22571	55	MHE-250W/4200K	12755	119
LUNIO DTO-W	29230	166	MHE-400W/4200K	12756	119
LUTO CTX-DS02B-AB	02584	187	MILENO EL-10 ASR-AN	29111	150
LUTO CTX-DS02B-C	02581	187	MILENO EL-10 B-AG	29110	150
LUTO CTX-DS02B-C\M	02583	187	MILENO EL-21 ASR-AN	29115	150
LUTO CTX-DS02B-W	02580	187	MILENO EL-21 B-AG	29114	150
LUTO CTX-DT02B-AB	02594	187	MILENO EL-31 ASR-AN	29117	150
LUTO CTX-DT02B-C	02591	187	MILENO EL-31 B-AG	29116	150
LUTO CTX-DT02B-C\M	02593	187	MILENO EL-30 ASR-AN	29113	150
LUTO CTX-DT02B-W	02590	187	MILENO EL-30 B-AG	29112	150
MAGRA EL-135	18010	299	MILENO EL-41 ASR-AN	29119	150
MAGRA EL-235	18011	299	MILENO EL-41 B-AG	29118	150
MAH LED HI 19W-NW RYF	22606	251	MILO 7040T	70522	271
MAH LED HI 38W-NW RYF	22607	251	MILO 7040T/P	70523	271
MAH LED HI 48W-NW RYF	22608	251	MINI BORD DLP-50-B	28783	159
MAH PLUS-118-ABS/PC	18515	256	MINI BORD DLP-50-W	28782	159
MAH PLUS-136/4LED/PC	22802	255	MINI GORD DLP-50-B	28781	159
MAH PLUS-136-ABS/PC	18519	256	MINI GORD DLP-50-W	28780	159
MAH PLUS-158/4LED/PC	22803	255	MINI RITI GU10 B/B	27578	158
MAH PLUS-158-ABS/PC	18523	256	MINI RITI GU10 B/G	27575	158
MAH PLUS-218-ABS/PC	18517	256	MINI RITI GU10 B/W	27577	158
MAH PLUS-236/4LED/PC	22800	255	MINI RITI GU10 W/G	27576	158
MAH PLUS-236-ABS/PC	18521	256	MINI RITI GU10 W/W	27579	158
MAH PLUS-258/4LED/PC	22801	255	MODv2 12W LED-NW	29301	87
MAH PLUS-258-ABS/PC	18525	256	MODv2 12W LED-WW	29300	87
MAH-LED N 20W-NW/PC	22603	251	MODv2 19W LED-NW	29303	87
MAH-LED N 40W-NW/PC	22604	251	MODv2 19W LED-WW	29302	87
MAH-LED N 50W-NW/PC	22605	251	MOLI EL-10	07085	155
MARC DL-60	07015	270	MOLI EL-21	07086	155
MARID JQ-L	08910	335	MOLI EL-30	07087	155
MARIN CT-S80-AB	04710	193	MOLI EL-41	07088	155
MARIN CT-S80-B	32501	193	MORO DL-35	04870	310
MARIN CT-S80-C	04703	193	MORTA B CT-DSL50-B	22110	175
MARIN CT-S80-SN	04704	193	MORTA B CT-DSL50-SR	22112	175
MARIN CT-S80-W	32500	193	MORTA B CT-DSO50-B	22116	175
MATEO DLP-150-GR	04960	277	MORTA B CT-DSO50-SR	22117	175

INDEKS ALFABETYCZNY

ALPHABETICAL INDEX

MORTA CT-DSL250-B	19360	173	ONTECSM2302MSTW	27828	363
MORTA CT-DSL250-SR	19362	173	ONTECSM5105MATW	27648	363
MORTA CT-DSL50-B	18510	173	ONTECSM5105MSTW	27829	363
MORTA CT-DSL50-SR	18512	173	ONTECSM5305MATW	27649	363
MORTA CT-DSO50-B	19440	173	ONTECSM5305MSTW	27830	363
MORTA CT-DSO50-SR	19442	173	ONTECSW1302MATW	27664	363
MORTA CT-DTL50-B	26719	174	ONTECSW1302MSTW	27892	363
MORTA CT-DTL50-SR	26718	174	ORTE LED 18W-NW-O	29160	264
MORTA CT-DTO50-B	26717	174	ORTE LED 18W-NW-O-SE	29162	264
MORTA CT-DTO50-SR	26716	174	ORTE LED 24W-NW-O	29161	264
MORTA OCT-B	26715	176	ORTE LED 24W-NW-O-SE	29163	264
MORTA OCT-SR	26714	176	OSŁ.SUF.ONTEC S009	27764	363
NANO W-1	70514	356	OSŁONA.ŚCIEN.ONT.S008	27763	363
NAVI CTX-DS10-AB	04693	186	OYO 2LED-CW	08120	202
NAVI CTX-DS10-B	25990	186	OYO 5LED-CW	08121	202
NAVI CTX-DS10-C	04694	186	PAX LED 10W NW	22192	219
NAVI CTX-DS10-SN	04695	186	PESSA LED IP44 17W-NW	27533	205
NAVI CTX-DT10-AB	02554	186	PESSA LED IP44 9W-NW	27531	205
NAVI CTX-DT10-B	25991	186	PICTO ONTEC G TMP1	27480	368
NAVI CTX-DT10-C	02551	186	PICTO ONTEC G TMP10	27487	368
NAVI CTX-DT10-C\M	02553	186	PICTO ONTEC G TMP11	27488	368
NAVI CTX-DT10-W	02550	186	PICTO ONTEC G TMP12	27489	368
NESTA DSL-B	26746	183	PICTO ONTEC G TMP13	27490	368
NESTA DSL-C	26747	183	PICTO ONTEC G TMP14	27491	368
NESTA DSL-C\M	26748	183	PICTO ONTEC G TMP15	27492	368
NESTA DSL-W	26745	183	PICTO ONTEC G TMP16	27493	368
NESTA DTL-B	26750	183	PICTO ONTEC G TMP17	27494	368
NESTA DTL-C	26751	183	PICTO ONTEC G TMP18	27495	368
NESTA DTL-C\M	26752	183	PICTO ONTEC G TMP2	27481	368
NESTA DTL-W	26749	183	PICTO ONTEC G TMP22	27497	368
NIKOR DLP-60-W	07210	284	PICTO ONTEC G TMP23	27498	368
NOKA O 16A 3G1,5X25M	26207	354	PICTO ONTEC G TMP5	27482	368
NOKA O 16A 3G1,5X30M	26208	354	PICTO ONTEC G TMP50	27501	368
NOKA W 10A 3G1,0X10M	26204	354	PICTO ONTEC G TMP51	27502	368
NOKA W 10A 3G1,0X3M	26201	354	PICTO ONTEC G TMP6	27483	368
NOKA W 10A 3G1,0X5M	26202	354	PICTO ONTEC G TMP67	27499	368
NOMA CTX-DS10G/B-C	02566	200	PICTO ONTEC G TMP68	27500	368
NOME N LED SMD 18W-NW	25493	254	PICTO ONTEC G TMP7	27484	368
NOME N LED SMD 36W-NW	25494	254	PICTO ONTEC G TMP8	27485	368
NOME N LED SMD 48W-NW	25495	254	PICTO ONTEC G TMP9	27486	368
NOTUS 3 EVG 218 NT	19733	246	PICTO ONTEC S TMP1	27503	369
NOTUS 3 EVG 236 NT	19732	246	PICTO ONTEC S TMP10	27510	369
NOTUS 3 EVG 418 NT	19731	246	PICTO ONTEC S TMP11	27511	369
NOTUS 3WS EVG 236 NT	25712	246	PICTO ONTEC S TMP12	27512	369
NOTUS 3WS EVG 418 NT	25711	246	PICTO ONTEC S TMP13	27513	369
NOTUS 4LED 236 NT	22672	248	PICTO ONTEC S TMP14	27514	369
NOTUS 4LED 418 NT	22671	248	PICTO ONTEC S TMP15	27515	369
NOTUS PREMIUM 236 NT	22290	247	PICTO ONTEC S TMP16	27516	369
NOTUS PREMIUM 418 NT	22291	247	PICTO ONTEC S TMP17	27517	369
NOVIA 120 D	25661	316	PICTO ONTEC S TMP18	27518	369
NOVIA EL 120 D	25662	316	PICTO ONTEC S TMP2	27504	369
NOVIA EL 220 U/D	25663	316	PICTO ONTEC S TMP21	27519	369
OFIS LED	xxx	32-35	PICTO ONTEC S TMP22	27520	369
OFIS S LED	xxx	36-37	PICTO ONTEC S TMP23	27521	369
OGIVA D35 GR	27001	122	PICTO ONTEC S TMP5	27505	369
OMERIS N LED 25W-NW-W	23362	284	PICTO ONTEC S TMP50	27524	369
ONSTAR LED-GR	22760	303	PICTO ONTEC S TMP51	27525	369
ONTEC G AT005 301	25435	366	PICTO ONTEC S TMP6	27506	369
ONTEC G E1B 101 M ST\	27394	366	PICTO ONTEC S TMP67	27522	369
ONTEC G E1B 301M ST\W	27395	366	PICTO ONTEC S TMP68	27523	369
ONTECCM2302MAT\W	27673	366	PICTO ONTEC S TMP7	27507	369
ONTECCM2302MST\W	27839	366	PICTO ONTEC S TMP8	27508	369
ONTECGE1B101MAT\W	27750	366	PICTO ONTEC S TMP9	27509	369
OntecRC1302MAT\W	27739	365	PIN W\US	02186	356
OntecRM2302MAT\W	27731	365	PIRES DL-600	08810	269
OntecRM5105MAT\W	27732	365	PIRES DL-600 NS	08811	269
OntecRM5105MST\W	27850	365	PIRES ECO DL-250	19000	269
ONTECSC1302MATW	27652	363	PIRES ECO DL-250 NS	19001	269
ONTECSC1302MSTW	27880	363	PIRMO LED SMD NW-GR	23710	219
ONTECSM1301MSTWIP44	27920	363	PIXA KT-40-B	19301	231
ONTECSM2102MATW	27646	363	PIXA KT-40-W	19300	231
ONTECSM2102MSTW	27827	363	PLAFMIN O	25690	143
ONTECSM2302MCOLDSTW	27831	363	PORTOS LED	29070	267

PORTOS LED SE	29071	267	REXAR LED W	33070	224
POWELED P 12V 30W	26810	345	RICO LED 10-18W	07302	346
POWELED P 12V 60W	26811	345	RILA 100	23584	320
PROFILO A	19160	100	RILA 23L-DOWN	23581	320
PROFILO B	19161	101	RILA 23L-UP	23580	320
PROFILO B 2m	26540	101	RILA 30	23583	320
PROFILO C	19162	102	RILA 81-PEND	23582	320
PROFILO C 2m	26541	102	RITI GU10 B/G	27571	135
PROFILO D	19163	103	RITI GU10 WG	27570	135
PROFILO D 2m	26542	103	RITI REF SR	27574	135
PROFILO E	19164	104	ROGER DL-2LED6	07281	310
PROFILO E 2m	26543	104	ROGER DL-LED12	07280	310
PROFILO F	26552	105	ROLF JQ-L	08820	337
PROFILO F 2m	26553	105	ROLF JQ-O	08821	338
PROFILO G	26558	106	ROLF MINI JQ-L	08822	336
PROFILO G 2m	26559	106	ROLSO LED IP44 15W-NW	26700	205
PROFILO H	26560	107	ROPE-NT 150	07870	246, 247, 248, 256
PROFILO H 2m	26561	107	ROPE-NT 150 SINGLE	07871	246, 247, 248, 256
PROFILO I	26554	108	ROUND A V2LED12W-NW-SR	28930	282
PROFILO I 2m	26555	108	ROUND A V2LED12W-NW-W	28931	282
PROFILO I-W	26556	108	ROUND A V2LED12W-WW-W	28932	282
PROFILO I-W 2m	26557	108	ROUND A V2LED18W-NW-SR	28933	282
PROFILO J	26544	109	ROUND A V2LED18W-NW-W	28934	282
PROFILO J 2M	26545	109	ROUND A V2LED18W-WW-W	28935	282
PROFILO J-W	26546	109	ROUND A V2LED24W-NW-W	28936	282
PROFILO J-W 2M	26547	109	ROUND A V2LED6W-NW-SN	27221	282
PROFILO K	26548	110	ROUND A V2LED6W-NW-W	28937	282
PROFILO K 2m	26549	110	ROUND A V2LED6W-WW-W	28938	282
PROFILO K-W	26550	110	RUBINAS 2LED CW	23791	221
PROFILO K-W 2m	26551	110	RUBINAS 2LED WW	23790	221
PSR 100	25591	239, 241	RUBINAS 3LED CW	23793	221
QULES AC L-B	26307	192	RUBINAS 3LED WW	23792	221
QULES AC L-C/M	26301	192	SABIK LED AC B-NW	29850	213
QULES AC L-W	26300	192	SABIK LED AC B-WW	29851	213
QULES AC O-B	26306	192	SABIK LED AC-CW	23803	213
QULES AC O-C	26305	192	SABIK LED AC-WW	23802	213
QULES AC O-C/M	26304	192	SABIK LED B-NW	29852	213
QULES AC O-W	26303	192	SABIK LED B-WW	29853	213
RADAN CT-DSL50	07363	188	SABIK LED CW	23110	213
RADAN CT-DSO50	07362	188	SABIK LED PIR B-NW	29858	213
RADAN CT-DTL50	07361	188	SABIK LED PIR B-WW	29859	213
RADAN CT-DTO50	07360	188	SABIK LED PIR CW	27375	213
RALF DL-220-W	04820	278	SABIK LED PIR WW	27374	213
RANGO MINI R7S SMD-WW	15099	88	SABIK LED WW	23108	213
RANGO R7S SMD-WW	15098	88	SABIK MINI LED B-NW	29854	213
RAPID E27-NW	32920	54	SABIK MINI LED B-WW	29855	213
RAPID E27-WW	32921	54	SABIK MINI LED CW	23111	213
RAPID HI E27-NW	32926	54	SABIK MINI LED WW	23109	213
RAPID HI E27-WW	32927	54	SANGA DL-100	08050	272
RAPID MAXX E27-NW	32924	54	SANI IP44 DSO-B	29240	131
RAPID MAXX E27-WW	32925	54	SANI IP44 DSO-W	29241	131
RAPID PRO E27-NW	32922	54	SANSO LED 15W-NW-SE	26520	266
RAPID PRO E27-WW	32923	54	SARI LED B-CH	27980	227
REF ATL1-18W-S15	33140	327	SARI LED B-SR	27981	227
REF ATL1-18W-S36	33141	327	SARI LED W-SR	27982	227
REF ATL1-30W-S15	33142	327	SEALINGS G	26602	106
REF ATL1-30W-S36	33143	327	SEIDY CT-DTL250-AL.	18282	170
REGIS 3 EVG 418 PT	19730	244	SEIDY CT-DTL250-B	18284	170
REGIS 3 OPAL 418 PT	19734	244	SEIDY CT-DTL250-W/M	19455	170
REGIS 3WS EVG 418 PT	25710	244	SEIDY CT-DTL50-AL.	18281	170
REGIS 3WS OPAL 418 PT	25713	244	SEIDY CT-DTL50-B	18289	170
REGIS 4LED 418 PT	22673	245	SEIDY CT-DTL50-W/M	19454	170
REGIS 4LED OPAL 418PT	19736	245	SEIDY CT-DTO50-AL.	18280	170
REKA LED EL 7W-L-GR	28990	301	SEIDY CT-DTO50-B	18288	170
REKA LED EL 7W-L-W	28992	301	SEMPRA EL-11 B-SR	33091	146
REKA LED EL 7W-O-GR	28991	301	SEMPRA EL-11 W-SR	33090	146
REKA LED EL 7W-O-W	28993	301	SEMPRA EL-21 B-SR	33093	146
REMI LED GU10-NW	33080	70	SEMPRA EL-21 W-SR	33092	146
REMI LED GU10-WW	33081	70	SEMPRA EL-31 B-SR	33095	146
REMOTE CCT	22145	97	SEMPRA EL-31 W-SR	33094	146
REMOTE MONO	22144	97	SEMPRA EL-41 B-SR	33097	146
REMOTE RGBW	22146	99	SEMPRA EL-41 W-SR	33096	146
REXAR LED B	33071	224	SENTO	26820	340

INDEKS ALFABETYCZNY

ALPHABETICAL INDEX

SENZO	26821	340	SOLCA L PV 50 SPI-B	25776	324
SEORA LED AC B-NW	32480	212	SOLCA L PV 50-B	25775	324
SEORA LED AC B-WW	32481	212	SOLCA L PV EL-B	25774	324
SEORA LED AC NW	32484	212	SOLCA O PV 50 SPI-B	25773	325
SEORA LED AC WW	32485	212	SOLCA O PV 50-B	25772	325
SEORA LED B-NW	32482	212	SOLCA O PV EL-B	25771	325
SEORA LED B-WW	32483	212	SONDA EL-1L	04795	154
SEORA LED NW	32486	212	SONDA EL-2J	04796	154
SEORA LED WW	32487	212	SONDA EL-3J	04797	154
SET105-K	01426	346	SONDA EL-4L	04798	154
SET60-K	01425	346	SONOR GU10 CO-B WW	24362	124
SEVIA LED 26	23550	314	SONOR GU10 CO-W WW	24363	124
SEVIA LED 26-SE	23551	314	SOREN L-BL	24414	177
SEVIA LED 50	23552	314	SOREN L-SR CW	24417	177
SEVIA LED 80	23554	314	SOREN L-SR WW	24413	177
SHADE C/D/E/I-FR 2M	26573	102, 103, 104, 108	SOREN O-BL	24411	177
SHADE C/D/E/I-W	26574	102, 103, 104, 108	SOREN O-SR CW	24416	177
SHADE C/D/E/I-W 2M	26572	102, 103, 104, 108	SOREN O-SR WW	24410	177
SHADE A-FR	19170	100	SORTA 16L-UP	25680	319
SHADE B/F-FR	26568	101, 105	SORTA 16L-UP-SE	25681	319
SHADE B/F-FR 2M	26570	101, 105	SORTA 30I-UP	25682	319
SHADE B/F-W	26569	101, 105	SORTA 50	25683	319
SHADE B/F-W 2M	26571	101, 105	SORTA 80	25684	319
SHADE C/D/E/I-FR	26572	102, 103, 104, 108	SPAG C B/G	27324	165
SHADE CK C/D/E/I-FR	26576	102, 103, 104, 108	SPAG C W/G	27325	165
SHADE CK C/D/E/I-FR2M	26577	102, 103, 104, 108	SPAG D B/G	27326	165
SHADE CK C/D/E/I-W	26578	102, 103, 104, 108	SPAG D W/G	27327	165
SHADE CK C/D/E/I-W 2M	26579	102, 103, 104, 108	SPAG L B/G	27320	165
SHADE CK G	26580	106	SPAG L W/G	27321	165
SHADE CK G 2M	26581	106	SPAG S B/G	27322	165
SHADE J/K-FR	26564	109, 110	SPAG S W/G	27323	165
SHADE J/K-FR 2m	26566	109, 110	SPN BRAVO S/P 12030	28505	239, 241
SHADE J/K-W	26565	109, 110	SPN BRAVO S/P 60-62	28504	239, 241
SHADE J/K-W 2m	26567	109, 110	SPRING I	26601	108
SHADE-O H-W	26586	107	STAN GP	04864	356
SHADE-O H-W 2m	26587	107	STATO 30W	29220	290
SHADE-U H-FR	26582	107	STATO 50W	29221	290
SHADE-U H-FR 2m	26583	107	STEL LED 350 8-12W	23070	346
SHADE-U H-W	26584	107	STER TS-MF1	01001	343
SHADE-U H-W 2m	26585	107	STOBI DLP 250-B	26832	126
SHARK N EL-60	29060	274	STOBI DLP 250-W	26833	126
SIGO R39 LED E14-NW	22734	74	STOBI DLP 350-B	26834	126
SIGO R39 LED E14-WW	22733	74	STOBI DLP 350-W	26835	126
SIGO R50 LED E14-NW	22736	74	STOBI DLP 450-B	26836	126
SIGO R50 LED E14-WW	22735	74	STOBI DLP 450-W	26837	126
SIGO R63 LED E27-NW	22738	74	STOBI DLP 50-B	26830	126
SIGO R63 LED E27-WW	22737	74	STOBI DLP 50-W	26831	126
SILMA LED EL-10	24440	156	STOBI ES 250-B	26838	125
SILMA LED EL-20	24441	156	STOBI ES 250-W	26839	125
SILMA LED EL-30	24442	156	STOBI ES 50-B	26828	125
SILMA LED EL-40	24443	156	STOBI ES 50-W	26829	125
SIMEN DSL B/B/G	29136	163	STONO 20 N	24654	323
SIMEN DSL B/G/B	29134	163	STONO 30	24651	323
SIMEN DSL B/W/B	29131	163	STONO 40	24652	323
SIMEN DSL SR/B/B	29132	163	STONO 50	24653	323
SIMEN DSL W/G/W	29135	163	STONO IS	24656	323
SIMEN DSL W/W/B	29130	163	STOPPER B	19181	101
SIMEN DSL W/WG	29133	163	STOPPER C	19182	102
SIMEN DSO B/G	29137	162	STOPPER D	19183	103
SIMEN DSO B/W	29138	162	STOPPER E	19184	104
SIMEN DSO G/B	29141	162	STOPPER F	26590	105
SIMEN DSO G/W	29142	162	STOPPER G	26592	106
SIMEN DSO SR/B	29143	162	STOPPER I	26591	108
SIMEN DSO W/B	29139	162	STOPPER I-W	26603	108
SIMEN DSO WG	29140	162	STOPPER J	26588	109
SLICK JQ-L-B	08391	337	STOPPER J-W	26605	109
SLICK JQ-L-W	08390	337	STOPPER K	26589	110
SOLA LED AC B-NW	27556	214	STOPPER K-W	26606	110
SOLA LED AC B-WW	27557	214	STOPPER-O H	26594	107
SOLA LED AC-WW	23804	214	STOPPER-U H	26593	107
SOLA LED B-NW	27558	214	STRAP 2,5\100MM	07962	370
SOLA LED B-WW	27559	214	STRAP 2,5\120MM	07963	370
SOLA LED WW	23100	214	STRAP 2,5\150MM	07965	370

STRAP 3,6\150MM	07966	370	TEAR N EPLUG W	33236	330
STRAP 3,6\200MM	07967	370	TEAR N ICON-I B	33239	330
STRAP 3,6\250MM	07968	370	TEAR N ICON-I W	33238	330
STRAP 3,6\300MM	07969	370	TEAR N PCON L-B	33261	330
STRAP 4,6\200MM	07970	370	TEAR N PCON L-W	33260	330
STRAP 4,6\250MM	07971	370	TEAR N PCON R-B	33235	330
STRAP 4,6\300MM	07972	370	TEAR N PCON R-W	33234	330
STREET LED 12000 NW	27332	292	TEAR N SCLAMP B	33255	330
STREET LED 4000 NW	27330	292	TEAR N SCLAMP W	33254	331
STREET LED 8000 NW	27331	292	TEAR N SKIT B	33257	330
STREET LED ADTR 15D	27333	292	TEAR N SKIT W	33256	330
SUZI HR-60-B	07151	229	TEAR N TR 1M-B	33231	330
SUZI HR-60-BL	07152	229	TEAR N TR 1M-W	33230	330
SUZI HR-60-PK	07153	229	TEAR N TR 2M-B	33233	330
SUZI HR-60-SR	07150	229	TEAR N TR 2M-W	33232	330
T1U-11W/K	10672	115	TEDI MAXX LED GU10-CW	23413	72
T1U-9W/K	10671	115	TEDI MAXX LED GU10-NW	23414	72
T2U-18W/K	10661	115	TEDI MAXX LED GU10-WW	23412	72
T2U-26W/K	10662	115	TERRA LED AC B-NW	26846	211
T5-13W 4000K/65	12716	117	TERRA LED AC B-WW	26847	211
T5-14W 4000K/82	12717	117	TERRA LED AC-CW	23807	211
T5-8W 4000K/65	12715	117	TERRA LED AC-WW	23806	211
T8 18W/840 NW	19921	118	TERRA LED B-NW	26848	211
T8 18W/865 CW	19922	118	TERRA LED B-WW	26849	211
T8 36W/840 NW	19924	118	TERRA LED CW	23104	211
T8 36W/865 CW	19925	118	TERRA LED PIR B-NW	29860	211
T8 58W/840 NW	19927	118	TERRA LED PIR B-WW	29861	211
T8 58W/865 CW	19928	118	TERRA LED PIR CW	27373	211
T8 LED GLASSv2 18W-CW	26060	82	TERRA LED PIR WW	27372	211
T8 LED GLASSv2 18W-NW	22655	82	TERRA LED W-CW	26843	211
T8 LED GLASSv2 18W-WW	22656	82	TERRA LED WW	23102	211
T8 LED GLASSv2 24W-CW	26061	82	TERRA LED W-WW	26842	211
T8 LED GLASSv2 24W-NW	22657	82	TERRA MINI LED B-NW	27376	211
T8 LED GLASSv2 9W-CW	22659	82	TERRA MINI LED B-WW	27377	211
T8 LED GLASSv2 9W-NW	22654	82	TESON AL-DSL50	07373	189
T8 LED GLASSv2 9W-WW	22658	82	TESON AL-DSO50	07372	189
T8 LED GLASSv3 18W-CW	26065	83	TESON AL-DTL50	07371	189
T8 LED GLASSv3 18W-NW	26064	83	TESON AL-DTO50	07370	189
T8 LED GLASSv3 24W-CW	26067	83	TIBERI LED SMD 24W-O	25510	278
T8 LED GLASSv3 24W-NW	26066	83	TIBERI LED SMD 36W-O	25511	278
T8 LED GLASSv3 9W-CW	26063	83	TIVA 1030 1/2DR/ML-DB	70741	142
T8 LED GLASSv3 9W-NW	26062	83	TIVA 1030 1/2DR/ML-OL	70747	142
T8 LED GLASSv4 18W-CW	33213	85	TIVA 1030 1/2DR/ML-SN	70740	142
T8 LED GLASSv4 18W-NW	33212	85	TIVA 1030 SDR/ML-DB	70721	142
T8 LED GLASSv4 24W-CW	33215	85	TIVA 1030 SDR/ML-OL	70727	142
T8 LED GLASSv4 24W-NW	33214	85	TIVA 1030 SDR/ML-SN	70720	142
T8 LED GLASSv4 9W-CW	33211	85	TIVA 1130 DDR/ML-DB	70711	142
T8 LED GLASSv4 9W-NW	33210	85	TIVA 1130 DDR/ML-OL	70717	142
T8LED GLASSv3T 18W NW	26068	84	TIVA 1130 DDR/ML-SN	70710	142
TANO G4 SMD-WW	14936	77	TOLEO DTL250-AL.	26121	136
TAXI SMD L C/M-NW	26461	306	TOLEO DTL250-B	26119	136
TAXI SMD L C/M-WW	26460	306	TOLEO DTL50-AL.	26115	136
TAXI SMD P C/M-NW	26463	306	TOLEO DTL50-B	26113	136
TAXI SMD P C/M-WW	26462	306	TOLEO DTL50-W	26114	136
TEAR N CON-I B	33241	331	TOLEO DTO50-B	26110	136
TEAR N CON-I FLEX B	33253	331	TOLEO DTO50-W	26111	136
TEAR N CON-I FLEX W	33252	331	TOMI LED1,2W GU10-CW	22709	71
TEAR N CON-I W	33240	331	TOMI LED1,2W GU10-NW	22822	71
TEAR N CON-L LR-B	33245	331	TOMI LED1,2W GU10-WW	22708	71
TEAR N CON-L LR-W	33244	331	TOMI LED3W GU10-CW	22703	71
TEAR N CON-L RL-B	33243	331	TOMI LED3W GU10-NW	22823	71
TEAR N CON-L RL-W	33242	331	TOMI LED3W GU10-WW	22702	71
TEAR N CON-T LLR-B	33265	331	TOMI LED5W GU10-CW	22701	71
TEAR N CON-T LLR-W	33264	331	TOMI LED5W GU10-NW	22824	71
TEAR N CON-T LRR-B	33263	331	TOMI LED5W GU10-WW	22700	71
TEAR N CON-T LRR-W	33262	330	TOMI LED5W MRI6-CW	22705	73
TEAR N CON-T RLL-B	33251	330	TOMI LED5W MRI6-WW	22704	73
TEAR N CON-T RLL-W	33250	330	TOMI LED7W GU10-CW	22820	71
TEAR N CON-T RRL-B	33249	331	TOMI LED7W GU10-NW	22825	71
TEAR N CON-T RRL-W	33248	331	TOMI LED7W GU10-WW	22821	71
TEAR N CON-X B	33247	330	TOMI LED7W MRI6-CW	22707	73
TEAR N CON-X W	33246	330	TOMI LED7W MRI6-WW	22706	73
TEAR N EPLUG B	33237	330	TONIL LED B *OPRAWA LED	33250	203

INDEKS ALFABETYCZNY

ALPHABETICAL INDEX

TONIL LED W *OPRAWA LED	32521	203	XLED A60 7W-WW	29601	49
TORIM DLP-250 B-W	28463	139	XLED A60 7W-WW-M	29609	51
TOWE LED 36W-NW	25790	242	XLED A60 8W-CW-M	29614	51
TP SLIM LED 40W-NW	27115	253	XLED A60 8W-NW-M	29613	51
TP SLIM LED 50W-NW	27116	253	XLED A60 8W-WW	29604	49
TP SLIM TW LED 40W-NW	27117	253	XLED A60 8W-WW-M	29612	51
TP SLIM TW LED 50W-NW	27118	253	XLED A60 B22 10W-CW	33107	52
TP STRONG LED 48W-NW	33170	250	XLED A60 B22 10W-CW-M	33109	52
TP STRONG LED 75W-NW	33171	250	XLED A60 B22 10W-WW-M	33108	52
TRETO LED 30W	07800	347	XLED A60 B22 7W-CW	33101	52
TUME LED EL-10	24450	157	XLED A60 B22 7W-CW-M	33103	52
TUME LED EL-20	24451	157	XLED A60 B22 7W-WW	33100	52
TUME LED EL-30	24452	157	XLED A60 B22 7W-WW-M	33102	52
TUME LED EL-40	24453	157	XLED A60 B22 8W-CW-M	33106	52
TUNA MINI N	08091	273	XLED A60 B22 8W-WW	33104	52
TUNA S1101-W	04260	273	XLED A60 B22 8W-WW-M	33105	52
TURK DL-60	07025	273	XLED A70 15W-NW	29640	50
TURRO LED 30W-NW	18982	308	XLED A70 15W-WW	29639	50
TWISTER AOL100B	70926	350	XLED C35E14 2,5W-WW	29617	59
TWISTER AOL100T	70953	350	XLED C35E14 4,5W-NW	29619	59
TWISTER AOL120B	70956	350	XLED C35E14 4,5W-NW-M	29621	60
TWISTER AOL120T	70960	350	XLED C35E14 4,5W-WW	29618	59
TYBIA LED 38W-NW	24640	265	XLED C35E14 4,5W-WW-M	29620	60
TYBIA LED 38W-NW-SE	24641	265	XLED C35E14 6W-NW-M	29623	60
URTICA CT-DT050-AB	19550	199	XLED C35E14 6W-WW-M	29622	60
VADRA 16L-UP	29010	318	XLED C35E27 6W-NW-M	29647	60
VADRA 21L-UP SE	29011	318	XLED C35E27 6W-WW-M	29646	60
VADRA 50	29012	318	XLED C35T 2,5W-SW	29641	57
VADRA 80	29013	318	XLED C35T 2,5W-SW	29645	57
VARSO HI 36W-NW-L	26449	262	XLED G125 5W-SW	29646	57
VARSO HI 36W-NW-L-SE	26986	262	XLED G125 7W-WW	29638	56
VARSO HI 36W-NW-O	26448	262	XLED G45 E14 4,5W-WW	29624	65
VARSO HI 36W-NW-O-SE	26985	262	XLED G45E14 4,5W-NW-M	29627	66
VARSO LED 18W-NW-L	26443	2625	XLED G45E14 4,5W-WW-M	29626	66
VARSO LED 18W-NW-L-SE	26980	262	XLED G45E14 6W-NW-M	29629	66
VARSO LED 18W-NW-O	26441	262	XLED G45E14 6W-WW-M	29628	66
VARSO LED 18W-NW-O-SE	26981	262	XLED G45E27 4,5W-NW-M	29631	66
VARSO LED 18W-WW-L	26442	262	XLED G45E27 4,5W-WW	29625	65
VARSO LED 18W-WW-O	26440	262	XLED G45E27 4,5W-WW-M	29630	66
VARSO LED 24W-NW-L	26447	262	XLED G45E27 6W-NW-M	29633	66
VARSO LED 24W-NW-L-SE	26983	262	XLED G45E27 6W-WW-M	29632	66
VARSO LED 24W-NW-O	26445	262	XLED G95 5W-SW	29643	57
VARSO LED 24W-NW-O-SE	26984	262	XLED G95 5W-SW	29644	57
VARSO LED 24W-WW-L	26446	262	XLED ST64 7W-WW	29637	56
VARSO LED 24W-WW-O	26444	262	XLEDA60 7W-NW-STEPDIM	29635	53
VIDI CTC-5514-AN	02795	185	XLEDA60 7W-WW-STEPDIM	29634	53
VIDI CTC-5514-B	25995	185	ZAFIRAS LED CW	23701	221
VIDI CTC-5514-B	25996	185	ZAFIRAS LED WW	23700	221
VIDI CTC-5514-C	02791	185	ZARA HR-40-B	07561	230
VIDI CTC-5514-C\M	02793	185	ZARA HR-40-BL	07562	230
VIDI CTC-5514-W	02790	185	ZARA HR-40-OR	07563	230
VIDI CTC-5515-AN	02785	185	ZARA HR-40-SR	07560	230
VIDI CTC-5515-C	02781	185	ZARK KRT\2-1	02180	357
VIDI CTC-5515-C\M	02783	185	ZARK KRW-3	02181	357
VIDI CTC-5515-W	02780	185	ZEST, MONT,FLAGI	27397	364
VIP 136 ST 2	27400	367	ZEST.MONT.P\T ONTEC G	27051	366
VIP 158 ST 2	27401	367	ZEST.MONT.P\T ONTEC R	27399	365
WIR ZLI00	70961	349	ZESTAW OG-M.WPUSZCZB	27946	366
WIR ZLI20	70962	349	ZESTAW OG-M.WPUSZCZG	27947	366
XARD DL-40	07195	308	ZESTAW OR-M.WPUSZCZB	27948	365
XLED A60 10W-NW	29606	49	ZESTAW OR-M.WPUSZCZG	27949	365
XLED A60 10W-NW-M	29616	51	ZEW EL-235J-B	22440	300
XLED A60 10W-WW	29605	49	ZEW EL-235J-GR	22442	300
XLED A60 10W-WW-M	29615	51	ZEW EL-235U-B	22441	300
XLED A60 4,5W-NW-M	29608	51	ZEW EL-235U-GR	22443	300
XLED A60 4,5W-WW	29600	49	ZONA FLAT-W	23452	342
XLED A60 4,5W-WW-M	29607	51	ZONA JQ-37-W	00464	335
XLED A60 5W-SW	29642	57	ZUBI HI LED4WG9-WW	24524	76
XLED A60 7W-CW	29603	49	ZUBI LED 3,5W E14-WW	24525	76
XLED A60 7W-CW-M	29611	51	ZUBI LED 3,5W G9-CW	24521	76
XLED A60 7W-NW	29602	49	ZUBI LED 3,5W G9-WW	24520	76
XLED A60 7W-NW-M	29610	51	ZUBI MAX LED3,5WG9-WW	24522	76
XLED A60 7W-STEP CCT	29636	53			

INDEKS WEDŁUG KODÓW

INDEX BY CODES

00300	ARGUS CT-2114-G	194	02820	HORN CTC-3114-SN/G	198
00301	ARGUS CT-2114-C	194	02821	HORN CTC-3114-SN/N	198
00303	ARGUS CT-2114-W	194	02823	HORN CTC-3114-PG/N	198
00304	ARGUS CT-2115-G	194	02824	HORN CTC-3114-GM/N	198
00305	ARGUS CT-2115-C	194	02830	HORN CTC-3115-SN/G	198
00307	ARGUS CT-2115-W	194	02831	HORN CTC-3115-SN/N	198
00309	ARGUS CT-2117-C	194	02834	HORN CTC-3115-GM/N	198
00311	ARGUS CT-2117-W	194	04011	AVIA MTH-478/400W-B	291
00324	ARGUS CT-2114-BR/M	194	04260	TUNA S1101-W	273
00325	ARGUS CT-2114-C/M	194	04381	LFD-T02-C/M ZEPO	218
00327	ARGUS CT-2114-AN	194	04386	LFD-T02/S-C/M ZEPO	218
00328	ARGUS CT-2114-GM	194	04680	DORA LED-J01	305
00330	ARGUS CT-2115-BR/M	194	04681	LINDA LED-J02	304
00331	ARGUS CT-2115-C/M	194	04693	NAVI CTX-DS10-AB	186
00333	ARGUS CT-2115-AN	194	04694	NAVI CTX-DS10-C	186
00334	ARGUS CT-2115-GM	194	04695	NAVI CTX-DS10-SN	186
00336	ARGUS CT-2117-BR/M	194	04703	MARIN CT-S80-C	193
00337	ARGUS CT-2117-C/M	194	04704	MARIN CT-S80-SN	193
00340	ARGUS CT-2117-GM	194	04710	MARIN CT-S80-AB	193
00402	HLDR-G210	360	04730	MERA TL-8/4000K	217
00405	HLDR-R7S	361	04731	MERA TL-13/4000K	217
00460	ALERJQ-30-W	334	04732	MERA TL-21/4000K	217
00461	ALERJQ-30-B	334	04733	MERA PP	217
00464	ZONA JQ-37-W	335	04795	SONDA EL-1L	154
00810	CT-2116B-W GAVI	220	04796	SONDA EL-2J	154
00811	CT-2116B-C GAVI	220	04797	SONDA EL-3J	154
00814	CT-2116B-BR/M GAVI	220	04798	SONDA EL-4L	154
00815	CT-2116B-C/M GAVI	220	04820	RALF DL-220-W	278
01001	STER TS-MF1	343	04842	ADAMO MTH-400/S	291
01016	CYBER TM-6	343	04846	ADAMO MTH-400/A	291
01257	IT-1\10-B	370	04862	GRIP GP\S	355
01271	IT-1\20-B	370	04863	GRIP W\US	355
01272	IT-1\20-Y	370	04864	STAN GP	356
01273	IT-1\20-RE	370	04870	MORO DL-35	310
01274	IT-1\20-GN	370	04960	MATEO DLP-150-GR	277
01275	IT-1\20-BL	370	04961	MATEO DLP-250-GR	277
01276	IT-1\20-W	370	04962	MATEO DLP-350-GR	277
01277	IT-1\20-Y\GN	370	07015	MARC DL-60	270
01283	IT-1\20-MIX	370	07025	TURK DL-60	273
01425	SET60-K	346	07080	BART EL-235	298
01426	SET105-K	346	07082	BART EL-260	298
01440	ADI 350 1x3W	344	07085	MOLI EL-10	155
02160	HLDR-E27	359	07086	MOLI EL-2I	155
02161	HLDR-E27-F	359	07087	MOLI EL-30	155
02162	HLDR-E27-D	359	07088	MOLI EL-4I	155
02170	HLDR-E14	358	07150	SUZI HR-60-SR	229
02173	HLDR-E14-F	358	07151	SUZI HR-60-B	229
02180	ZARK KRT\2-1	357	07152	SUZI HR-60-BL	229
02181	ZARK KRW-3	357	07153	SUZI HR-60-PK	229
02186	PIN W\US	356	07170	BERG DL-350	309
02550	NAVI CTX-DT10-W	186	07171	BERG DL-35L	309
02551	NAVI CTX-DT10-C	186	07180	BS-1 4-22W	348
02553	NAVI CTX-DT10-C\M	186	07181	BS-2 4-65W	348
02554	NAVI CTX-DT10-AB	186	07195	XARD DL-40	308
02566	NOMA CTX-DS10G/B-C	200	07210	NIKOR DLP-60-W	284
02576	DINO CTX-DS02G/B-C	200	07280	ROGER DL-LED12	310
02580	LUTO CTX-DS02B-W	187	07281	ROGER DL-2LED6	310
02581	LUTO CTX-DS02B-C	187	07302	RICO LED 10-18W	346
02583	LUTO CTX-DS02B-C\M	187	07360	RADAN CT-DT050	188
02584	LUTO CTX-DS02B-AB	187	07361	RADAN CT-DTL50	188
02590	LUTO CTX-DT02B-W	187	07362	RADAN CT-DS050	188
02591	LUTO CTX-DT02B-C	187	07363	RADAN CT-DSL50	188
02593	LUTO CTX-DT02B-C\M	187	07370	TESON AL-DT050	189
02594	LUTO CTX-DT02B-AB	187	07371	TESON AL-DTL50	189
02755	CEL CTC-5519-C/M	178	07372	TESON AL-DS050	189
02780	VIDI CTC-5515-W	185	07373	TESON AL-DSL50	189
02781	VIDI CTC-5515-C	185	07560	ZARA HR-40-SR	230
02783	VIDI CTC-5515-C\M	185	07561	ZARA HR-40-B	230
02785	VIDI CTC-5515-AN	185	07562	ZARA HR-40-BL	230
02790	VIDI CTC-5514-W	185	07563	ZARA HR-40-OR	230
02791	VIDI CTC-5514-C	185	07690	MERGE JQ-L	336
02793	VIDI CTC-5514-C\M	185	07691	MERGE JQ-O	338
02795	VIDI CTC-5514-AN	185	07800	TRETO LED 30W	347
02804	BASK CTC-5515-MPC/N	197	07870	ROPE-NT 150	246, 247, 248, 256
02806	BASK CTC-5515-SN/N	197	07871	ROPE-NT 150 SINGLE	246, 247, 248, 256
02814	BASK CTC-5514-MPC/N	197	07900	KIRA DL-75B	270
02816	BASK CTC-5514-SN/N	197	07962	STRAP 2,5x100MM	370

INDEKS WEDŁUG KODÓW

INDEX BY CODES

07963	STRAP 2,5\120MM	370	18040	DRIFT LED 0-6W	344
07965	STRAP 2,5\150MM	370	18042	DRIFT LED F 0-18W	222
07966	STRAP 3,6\150MM	370	18120	FOGLER DL-2400	268
07967	STRAP 3,6\200MM	370	18121	FOGLER LED 14W-NW	267
07968	STRAP 3,6\250MM	370	18131	GRIBLO LED SMD-NW	321
07969	STRAP 3,6\300MM	370	18280	SEIDY CT-DT050-AL.	170
07970	STRAP 4,6\200MM	370	18281	SEIDY CT-DTL50-AL.	170
07971	STRAP 4,6\250MM	370	18282	SEIDY CT-DTL250-AL.	170
07972	STRAP 4,6\300MM	370	18284	SEIDY CT-DTL250-B	170
07980	APO TM-3	357	18288	SEIDY CT-DT050-B	170
08050	SANGA DL-100	272	18289	SEIDY CT-DTL50-B	170
08091	TUNA MINI N	273	18420	G9-20W STAR	112
08103	HAXA-DSO POWER LED-B	201	18421	G9-33W STAR	112
08120	OYO 2LED-CW	202	18422	G9-48W STAR	112
08121	OYO 5LED-CW	202	18423	G9-60W STAR	112
08220	HLDR-G9	360	18502	LED12 G4-WW	78
08240	BL-3-4x14H-EVG	348	18503	LED12 G4-NW	78
08302	MERA TL-13/2700K	217	18510	MORTA CT-DSL50-B	173
08390	SLICK JQ-L-W	337	18512	MORTA CT-DSL50-SR	173
08391	SLICK JQ-L-B	337	18515	MAH PLUS-118-ABS/PC	256
08490	J-80W 78MM STAR	114	18517	MAH PLUS-218-ABS/PC	256
08491	J-120W 78MM STAR	114	18519	MAH PLUS-136-ABS/PC	256
08500	J-120W 118MM STAR	114	18521	MAH PLUS-236-ABS/PC	256
08501	J-160W 118MM STAR	114	18523	MAH PLUS-158-ABS/PC	256
08502	J-230W 118MM STAR	114	18525	MAH PLUS-258-ABS/PC	256
08503	J-400W 118MM STAR	114	18530	GWEN CT-DTL50-B	184
08550	DRIFT LED 3-18W	344	18531	GWEN CT-DT050-B	184
08630	GIVRO LED-CW 50M	111	18560	EVIT CT-DTL50-AL.	184
08631	GIVRO LED-BL 50M	111	18561	EVIT CT-DT050-AL.	184
08632	GIVRO LED-RE 50M	111	18587	GL-MAH-218 PLUS-PC	256
08633	GIVRO LED-GN 50M	111	18589	GL-MAH-136 PLUS-PC	256
08634	GIVRO LED-Y 50M	111	18593	CL-MAH PLUS	256
08635	GIVRO-X	111	18594	CL-MAH PLUS-INOX	256
08636	GIVRO-90L	111	18596	GL-MAH-158 PLUS-PC	256
08637	GIVRO PR SET	111	18960	CONTROLLER RGB-IR20	94
08638	GIVRO-Z	111	18982	TURRO LED 30W-NW	308
08639	GIVRO-I	111	19000	PIRES ECO DL-250	269
08640	GIVRO-PEND	111	19001	PIRES ECO DL-250 NS	269
08641	GIVRO-T	111	19036	CONNECTOR RGB 10-CP	94
08642	GIVRO LED-WW 50M	111	19037	CONNECTOR RGB 10-CPC	94
08810	PIRES DL-600	269	19038	CONNECTOR RGB 10	94
08811	PIRES DL-600 NS	269	19062	DABA N LED SMD DL-16W	265
08820	ROLF JQ-L	337	19063	DABA N LED SMD DL-22W	265
08821	ROLF JQ-O	338	19120	DARSA EL-135L-UP	299
08822	ROLF MINI JQ-L	336	19121	DARSA EL-235T-UP	299
08850	HLDR-E27/GU10	361	19160	PROFILO A	100
08851	HLDR-E14/GU10	361	19161	PROFILO B	101
08910	MARID JQ-L	335	19162	PROFILO C	102
08980	JURBA DL-218O	268	19163	PROFILO D	103
08981	JURBA DL-218L	268	19164	PROFILO E	104
10418	J-1000W 189MM	114	19170	SHADE A-FR	100
10419	J-1500W 254MM	114	19181	STOPPER B	101
10661	T2U-18W/K	115	19182	STOPPER C	102
10662	T2U-26W/K	115	19183	STOPPER D	103
10671	T1U-9W/K	115	19184	STOPPER E	104
10672	T1U-11W/K	115	19190	HANDLE A	100
10720	JC-5W G4	113	19300	PIXA KT-40-W	231
10722	JC-10W G4	113	19301	PIXA KT-40-B	231
10724	JC-20W G4	113	19360	MORTA CT-DSL250-B	173
10730	JC-20W GY6.35	113	19362	MORTA CT-DSL250-SR	173
10732	JC-35W GY6.35	113	19440	MORTA CT-DSO50-B	173
10734	JC-50W GY6.35	113	19442	MORTA CT-DSO50-SR	173
12660	DD-16W/4P 3500K	116	19454	SEIDY CT-DTL50-W/M	170
12661	DD-21W/4P 3500K	116	19455	SEIDY CT-DTL250-W/M	170
12662	DD-28W/4P 3500K	116	19550	URTICA CT-DT050-AB	199
12663	DD-38W/4P 3500K	116	19610	CANTA CTX-DS20	199
12715	T5-8W 4000K/65	117	19640	GLASO EL-10	153
12716	T5-13W 4000K/65	117	19641	GLASO EL-21	153
12717	T5-14W 4000K/82	117	19642	GLASO EL-31	153
12755	MHE-250W/4200K	119	19643	GLASO EL-41	153
12756	MHE-400W/4200K	119	19644	GLASO EL-30	153
14936	TANO G4 SMD-WW	77	19730	REGIS 3 EVG 418 PT	244
14977	LINUS LINK	218	19731	NOTUS 3 EVG 418 NT	246
15098	RANGO R7S SMD-WW	88	19732	NOTUS 3 EVG 236 NT	246
15099	RANGO MINI R7S SMD-WW	88	19733	NOTUS 3 EVG 218 NT	246
18010	MAGRA EL-135	299	19734	REGIS 3 OPAL 418 PT	244
18011	MAGRA EL-235	299	19736	REGIS 4LED OPAL 418PT	245

INDEKS WEDŁUG KODÓW

INDEX BY CODES

19761	GAVI LED18 SMD-WW-C/M	219	22733	SIGO R39 LED E14-WW	74
19921	T8 18W/840 NW	118	22734	SIGO R39 LED E14-NW	74
19922	T8 18W/865 CW	118	22735	SIGO R50 LED E14-WW	74
19924	T8 36W/840 NW	118	22736	SIGO R50 LED E14-NW	74
19925	T8 36W/865 CW	118	22737	SIGO R63 LED E27-WW	74
19927	T8 58W/840 NW	118	22738	SIGO R63 LED E27-NW	74
19928	T8 58W/865 CW	118	22760	ONSTAR LED-GR	303
19950	DUCE AL-DTL50	139	22770	CROTO LED-GR-L	304
19951	DUCE AL-DT050	139	22800	MAH PLUS-236/4LED/PC	255
22050	GORDO LED14 SMD-O	309	22801	MAH PLUS-258/4LED/PC	255
22051	GORDO LED14 SMD-L	309	22802	MAH PLUS-136/4LED/PC	255
22110	MORTA B CT-DSL50-B	175	22803	MAH PLUS-158/4LED/PC	255
22112	MORTA B CT-DSL50-SR	175	22820	TOMI LED7W GU10-CW	71
22116	MORTA B CT-DSO50-B	175	22821	TOMI LED7W GU10-WW	71
22117	MORTA B CT-DSO50-SR	175	22822	TOMI LED1,2W GU10-NW	71
22140	CONTROLLER LED RGB-RF	94	22823	TOMI LED3W GU10-NW	71
22141	CTRL 12V24V 10A MONO	97	22824	TOMI LED5W GU10-NW	71
22142	CTRL 12V24V 10A CCT	97	22825	TOMI LED7W GU10-NW	71
22143	CTRL 12V24V 10A RGBW	99	22960	AR-111 LED SL/WW/W	79
22144	REMOTE MONO	97	22962	AR-111 LED SL/WW/SR	79
22145	REMOTE CCT	97	22968	AR-111 LED SL/NW/SR	79
22146	REMOTE RGBW	99	22970	ES-111 LED SL/WW/W	80
22192	PAX LED 10W NW	219	22972	ES-111 LED SL/WW/SR	80
22203	LED15 C MR16-WW-B	73	22978	ES-111 LED SL/NW/SR	80
22204	LED15 C MR16-CW-B	73	23040	BILO 3W T SMD E14-WW	67
22290	NOTUS PREMIUM 236 NT	247	23041	BILO 3W T SMD E27-WW	67
22291	NOTUS PREMIUM 418 NT	247	23042	BILO 5W T SMD E14-WW	67
22340	FRANCO 15LED SMD KT-W	228	23043	BILO 5W T SMD E27-WW	67
22341	FRANCO 15LED SMD KT-B	228	23070	STEL LED 350 8-12W	346
22371	AZ-10A	342	23100	SOLA LED WW	214
22422	ESG LED 9W GX53-WW	86	23102	TERRA LED WW	211
22423	ESG LED 9W GX53-NW	86	23104	TERRA LED CW	211
22424	ESG LED 9W GX53-CW	86	23106	APUS LED WW	210
22430	DALLA CT-DT050-W	172	23107	APUS LED CW	210
22431	DALLA CT-DTL50-W	172	23108	SABIK LED WW	213
22432	DALLA CT-DT050-B	172	23109	SABIK MINI LED WW	213
22433	DALLA CT-DTL50-B	172	23110	SABIK LED CW	213
22440	ZEW EL-235J-B	300	23111	SABIK MINI LED CW	213
22441	ZEW EL-235U-B	300	23120	JASMIN 270-WE	141
22442	ZEW EL-235J-GR	300	23121	JASMIN 370-WE	141
22443	ZEW EL-235U-GR	300	23122	JASMIN 470-WE	141
22550	BORD DLP-50-AL	132	23123	JASMIN 270-W	141
22551	BORD DLP-50-W	132	23124	JASMIN 370-W	141
22552	BORD DLP-50-B	132	23125	JASMIN 470-W	141
22553	BORD DLP-250-AL	132	23126	JASMIN 270-W/M	141
22554	BORD DLP-250-W	132	23127	JASMIN 370-W/M	141
22555	BORD DLP-250-B	132	23128	JASMIN 470-W/M	141
22571	LUNI PRO E27 LED-WW	55	23129	JASMIN 470-A	141
22603	MAH-LED N 20W-NW/PC	251	23362	OMERIS N LED 25W-NW-W	284
22604	MAH-LED N 40W-NW/PC	251	23380	DUN 4,5W T SMD E14-WW	61
22605	MAH-LED N 50W-NW/PC	251	23381	DUN 4,5W T SMD E14-NW	61
22606	MAH LED HI 19W-NW RYF	251	23382	IDO 4,5W T SMD E14-WW	63
22607	MAH LED HI 38W-NW RYF	251	23383	IDO 4,5W T SMD E14-NW	63
22608	MAH LED HI 48W-NW RYF	251	23412	TEDI MAXX LED GU10-WW	72
22654	T8 LED GLASSv2 9W-NW	82	23413	TEDI MAXX LED GU10-CW	72
22655	T8 LED GLASSv2 18W-NW	82	23414	TEDI MAXX LED GU10-NW	72
22656	T8 LED GLASSv2 18W-WW	82	23420	BILO 6,5W T SMDE27-WW	67
22657	T8 LED GLASSv2 24W-NW	82	23421	BILO 6,5W T SMDE27-NW	67
22658	T8 LED GLASSv2 9W-WW	82	23422	BILO 6,5W T SMDE14-WW	67
22659	T8 LED GLASSv2 9W-CW	82	23423	BILO 6,5W T SMDE14-NW	67
22660	GIO LED G9-WW	75	23430	DUN 6,5W T SMD E14-WW	61
22661	GIO LED G9-NW	75	23431	DUN 6,5W T SMD E14-NW	61
22662	GIO LED G4 FL-WW	77	23450	ALER MINI-W	334
22663	GIO LED G4 FL-NW	77	23451	MERGE ADJ-O	339
22671	NOTUS 4LED 418 NT	248	23452	ZONA FLAT-W	342
22672	NOTUS 4LED 236 NT	248	23453	MERGE MW-L	339
22673	REGIS 4LED 418 PT	245	23490	IDO 6,5W T SMD E14-WW	63
22700	TOMI LED5W GU10-WW	71	23491	IDO 6,5W T SMD E14-NW	63
22701	TOMI LED5W GU10-CW	71	23510	IDAVA 25	322
22702	TOMI LED3W GU10-WW	71	23511	IDAVA 35	322
22703	TOMI LED3W GU10-CW	71	23512	IDAVA 47	322
22704	TOMI LED5W MR16-WW	73	23513	GL-IDAVA PS LS 25	322
22705	TOMI LED5W MR16-CW	73	23515	GL-IDAVA PS LS 47	322
22706	TOMI LED7W MR16-WW	73	23520	IMBER LED NW	201
22707	TOMI LED7W MR16-CW	73	23521	IMBER LED CW	201
22708	TOMI LED1,2W GU10-WW	71	23550	SEVIA LED 26	314
22709	TOMI LED1,2W GU10-CW	71	23551	SEVIA LED 26-SE	314

INDEKS WEDŁUG KODÓW

INDEX BY CODES

23552	SEVIA LED 50	314	25494	NOME N LED SMD 36W-NW	254
23553	SEVIA LED 50-SO	314	25495	NOME N LED SMD 48W-NW	254
23554	SEVIA LED 80	314	25510	TIBERI LED SMD 24W-O	278
23571	DIM-FF1 12/24VDC	222	25511	TIBERI LED SMD 36W-O	278
23572	DB-FF6 12/24VDC	222	25551	CYDEA D	233
23580	RILA 23L-UP	320	25560	LITEN LED 6W-WW	279
23581	RILA 23L-DOWN	320	25561	LITEN LED 6W-NW	279
23582	RILA 81-PEND	320	25562	LITEN LED 8W-WW	279
23583	RILA 30	320	25563	LITEN LED 8W-NW	279
23584	RILA 100	320	25591	PSR 100	239, 241
23700	ZAFIRAS LED WW	221	25661	NOVIA 120 D	316
23701	ZAFIRAS LED CW	221	25662	NOVIA EL 120 D	316
23710	PIRMO LED SMD NW-GR	219	25663	NOVIA EL 220 U/D	316
23756	JASMIN WE-W	141	25675	MERSA 300-W/M	140
23756	JASMIN 470-W-H	141	25678	MERSA 380-W/M	140
23757	JASMIN W-W	141	25680	SORTA 16L-UP	319
23758	JASMIN W/M-W	141	25681	SORTA 16L-UP-SE	319
23790	RUBINAS 2LED WW	221	25682	SORTA 30I-UP	319
23791	RUBINAS 2LED CW	221	25683	SORTA 50	319
23792	RUBINAS 3LED WW	221	25684	SORTA 80	319
23793	RUBINAS 3LED CW	221	25690	PLAFMIN O	143
23800	APUS LED AC-WW	210	25710	REGIS 3WS EVG 418 PT	244
23801	APUS LED AC-CW	210	25711	NOTUS 3WS EVG 418 NT	246
23802	SABIK LED AC-WW	213	25712	NOTUS 3WS EVG 236 NT	246
23803	SABIK LED AC-CW	213	25713	REGIS 3WS OPAL 418 PT	244
23804	SOLA LED AC-WW	214	25720	AKVEN LED	321
23806	TERRA LED AC-WW	211	25771	SOLCA O PV EL-B	325
23807	TERRA LED AC-CW	211	25772	SOLCA O PV 50-B	325
24240	CIRCO LED 12VDC 0-10W	345	25773	SOLCA O PV 50 SPI-B	325
24241	CIRCO LED 12VDC 0-15W	345	25774	SOLCA L PV EL-B	324
24362	SONOR GU10 CO-B WW	124	25775	SOLCA L PV 50-B	324
24363	SONOR GU10 CO-W WW	124	25776	SOLCA L PV 50 SPI-B	324
24410	SOREN O-SR WW	177	25780	IVIAN LED 4,5W W-WW	279
24411	SOREN O-BL	177	25781	IVIAN LED 4,5W SN-WW	279
24413	SOREN L-SR WW	177	25782	IVIAN LED 4,5W W-NW	279
24414	SOREN L-BL	177	25783	IVIAN LED 4,5W SN-NW	279
24416	SOREN O-SR CW	177	25790	TOWE LED 36W-NW	242
24417	SOREN L-SR CW	177	25800	BORD DLP-350-W	132
24440	SILMA LED EL-10	156	25802	BORD DLP-350-AL	132
24441	SILMA LED EL-20	156	25950	LUNGA 3 3G1,0X1,4M	352
24442	SILMA LED EL-30	156	25954	LUNGA 5 3 3G1,0X1,4M	353
24443	SILMA LED EL-40	156	25990	NAVI CTX-DS10-B	186
24450	TUME LED EL-10	157	25991	NAVI CTX-DT10-B	186
24451	TUME LED EL-20	157	25995	VIDI CTC-5514-B	185
24452	TUME LED EL-30	157	25996	VIDI CTC-5514-B	185
24453	TUME LED EL-40	157	26033	FULLED GU10-3,3W-WW	72
24510	LEDS-B 4.8W/M IP54-WW	89	26034	FULLED GU10-3,3W-NW	72
24511	LEDS-B 4.8W/M IP54-NW	89	26035	FULLED GU10-3,3W-CW	72
24512	LEDS-B 4.8W/M IP54-CW	89	26060	T8 LED GLASSv2 18W-CW	82
24513	LEDS-B 4.8W/M IP65-WW	89	26061	T8 LED GLASSv2 24W-CW	82
24514	LEDS-B 4.8W/M IP65-NW	89	26062	T8 LED GLASSv3 9W-NW	83
24515	LEDS-B 4.8W/M IP65-CW	89	26063	T8 LED GLASSv3 9W-CW	83
24516	LEDS-B 4.8W/M IP00-WW	89	26064	T8 LED GLASSv3 18W-NW	83
24517	LEDS-B 4.8W/M IP00-NW	89	26065	T8 LED GLASSv3 18W-CW	83
24518	LEDS-B 4.8W/M IP00-CW	89	26066	T8 LED GLASSv3 24W-NW	83
24520	ZUBI LED 3,5W G9-WW	76	26067	T8 LED GLASSv3 24W-CW	83
24521	ZUBI LED 3,5W G9-CW	76	26068	T8LED GLASSv3T 18W NW	84
24522	ZUBI MAX LED3,5WG9-WW	76	26091	DIVISO W 3	355
24524	ZUBI HI LED4WG9-WW	76	26110	TOLEO DTO50-B	136
24525	ZUBI LED 3,5W E14-WW	76	26111	TOLEO DTO50-W	136
24530	LEDS-B 7.2W/M IP00RGB	94	26113	TOLEO DTL50-B	136
24531	LEDS-B 7.2W/M IP65RGB	94	26114	TOLEO DTL50-W	136
24532	LEDS-B 7.2W/M IP54RGB	94	26115	TOLEO DTL50-AL	136
25435	ONTEC G AT005 301	366	26119	TOLEO DTL250-B	136
24640	TYBIA LED 38W-NW	265	26121	TOLEO DTL250-AL	136
24641	TYBIA LED 38W-NW-SE	265	26201	NOKA W 10A 3G1,0X3M	354
24651	STONO 30	323	26202	NOKA W 10A 3G1,0X5M	354
24652	STONO 40	323	26204	NOKA W 10A 3G1,0X10M	354
24653	STONO 50	323	26207	NOKA O 16A 3G1,5X25M	354
24654	STONO 20 N	323	26208	NOKA O 16A 3G1,5X30M	354
24656	STONO IS	323	26300	QULES AC L-W	192
25470	GORD DLP 50-W	134	26301	QULES AC L-C/M	192
25471	GORD DLP 50-B	134	26303	QULES AC O-W	192
25472	GORD DLP 50-AL	134	26304	QULES AC O-C/M	192
25473	GORD DLP 250-W	134	26305	QULES AC O-C	192
25474	GORD DLP 250-B	134	26306	QULES AC O-B	192
25493	NOME N LED SMD 18W-NW	254	26307	QULES AC L-B	192

INDEKS WEDŁUG KODÓW

INDEX BY CODES

26320	LEDS SET S-DIM IR	96	26571	SHADE B/F-W 2M	105
26321	LEDS SET S-DIM TS	96	26572	SHADE C/D/E/I-FR	102, 103, 104, 108
26323	LEDS SET W-SE BTRY	96	26573	SHADE C/D/E/I-FR 2M	102, 103, 104, 108
26360	ALDO 4LED 1X60	258	26574	SHADE C/D/E/I-W	102, 103, 104, 108
26361	ALDO 4LED 1X120	258	26575	SHADE C/D/E/I-W 2M	102, 103
26362	ALDO 4LED 1X150	258	26575	SHADE C/D/E/I-W	104, 108
26364	ALDO 4LED 2X120	258	26576	SHADE CK C/D/E/I-FR	102, 103, 104, 108
26365	ALDO 4LED 2X150	258	26577	SHADE CK C/D/E/I-FR 2M	102, 103, 104, 108
26440	VARSO LED 18W-WW-O	262	26578	SHADE CK C/D/E/I-W	102, 103, 104, 108
26441	VARSO LED 18W-NW-O	262	26579	SHADE CK C/D/E/I-W 2M	102, 103, 104, 108
26442	VARSO LED 18W-WW-L	262	26580	SHADE CK G	106
26443	VARSO LED 18W-NW-L	2625	26581	SHADE CK G 2M	106
26444	VARSO LED 24W-WW-O	262	26582	SHADE-U H-FR	107
26445	VARSO LED 24W-NW-O	262	26583	SHADE-U H-FR 2m	107
26446	VARSO LED 24W-WW-L	262	26584	SHADE-U H-W	107
26447	VARSO LED 24W-NW-L	262	26585	SHADE-U H-W 2m	107
26448	VARSO HI 36W-NW-O	262	26586	SHADE-O H-W	107
26449	VARSO HI 36W-NW-L	262	26587	SHADE-O H-W 2m	107
26460	TAXI SMD L C/M-WW	306	26588	STOPPER J	109
26461	TAXI SMD L C/M-NW	306	26589	STOPPER K	110
26462	TAXI SMD P C/M-WW	306	26590	STOPPER F	105
26463	TAXI SMD P C/M-NW	306	26591	STOPPER I	108
26480	MERIL DLP-50-W	180	26592	STOPPER G	106
26481	MERIL DLP-250-W	180	26593	STOPPER-U H	107
26490	AWAN LED S-W	226	26594	STOPPER-O H	107
26491	AWAN LED C-W	226	26595	HANDLE J/K	109, 110
26500	LUNGA 3 3G1,0X3M	352	26596	HANDLE B/F	101, 105
26501	LUNGA 3 3G1,0X5M	352	26597	HANDLE C/D/E/I	102, 103, 104, 108
26505	LUNGA 5 3G1,0X5M	352	26598	HANDLE G	106
26508	LUNGA S3 3G1,0X3M	353	26599	HANDLE H	107
26509	LUNGA S3 3G1,0X5M	353	26600	HANDLE SIDE H	107
26510	LUNGA S4 3G1,0X3M	353	26601	SPRING I	108
26512	LUNGA S5 3G1,0X3M	353	26602	SEALINGS G	106
26520	SANSO LED 15W-NW-SE	266	26603	STOPPER I-W	108
26536	APUS LED AC B-NW	210	26604	CONNECT-L B	101
26537	APUS LED AC B-WW	210	26605	STOPPER J-W	109
26538	APUS LED B-NW	210	26606	STOPPER K-W	110
26539	APUS LED B-WW	210	26616	ARTO 3L-SR	278
26540	PROFILO B 2m	101	26630	G9 GLASS LED2W-WW	75
26541	PROFILO C 2m	102	26631	G9 GLASS LED2W-CW	75
26542	PROFILO D 2m	103	26680	ASTEN LED IP44 8W-NW	206
26543	PROFILO E 2m	104	26681	ASTEN LED IP44 12W-NW	206
26544	PROFILO J	109	26682	ASTEN LED IP44 15W-NW	206
26545	PROFILO J 2M	109	26683	ASTEN IP44 8W-NW-B	206
26546	PROFILO J-W	109	26684	ASTEN IP44 12W-NW-B	206
26547	PROFILO J-W 2M	109	26690	DOSAN LED W	223
26548	PROFILO K	110	26691	DOSAN LED B	223
26549	PROFILO K 2m	110	26700	ROLSO LED IP44 15W-NW	205
26550	PROFILO K-W	110	26714	MORTA OCT-SR	176
26551	PROFILO K-W 2m	110	26715	MORTA OCT-B	176
26552	PROFILO F	105	26716	MORTA CT-DT050-SR	174
26553	PROFILO F 2m	105	26717	MORTA CT-DT050-B	174
26554	PROFILO I	108	26718	MORTA CT-DTL50-SR	174
26555	PROFILO I 2m	108	26719	MORTA CT-DTL50-B	174
26556	PROFILO I-W	108	26720	ARET 1XMR16-W	179
26557	PROFILO I-W 2m	108	26721	ARET 1XMR16-GR	179
26558	PROFILO G	106	26723	ARET 2XMR16-W	179
26559	PROFILO G 2m	106	26726	ALOR DSL-W	196
26560	PROFILO H	107	26727	ALOR DSL-B	196
26561	PROFILO H 2m	107	26728	ALOR DSL-C	196
26562	CONNECT-L C	102	26729	ALOR DSL-C/M	196
26563	CONNECT C/D/E/I	102, 103, 104, 108	26732	ALOR DTL-B	196
26564	SHADE J/K-FR	109	26736	IVRI DTO-W	178
26564	SHADE J/K-FR	110	26738	APRILA DTO-W	176
26565	SHADE J/K-W	109	26739	APRILA DTL-W	176
26565	SHADE J/K-W	110	26740	COLIE DTO-W	182
26566	SHADE J/K-FR 2m	109	26741	COLIE DTO-G	182
26566	SHADE J/K-FR 2m	110	26742	COLIE DTO-AL	182
26567	SHADE J/K-W 2m	109	26743	COLIE DTO-B	182
26567	SHADE J/K-W 2m	110	26744	COLIE DTO-GR	182
26568	SHADE B/F-FR	101	26745	NESTA DSL-W	183
26568	SHADE B/F-FR	105	26746	NESTA DSL-B	183
26569	SHADE B/F-W	101	26747	NESTA DSL-C	183
26569	SHADE B/F-W	105	26748	NESTA DSL-C/M	183
26570	SHADE B/F-FR 2M	101	26749	NESTA DTL-W	183
26570	SHADE B/F-FR 2M	105	26750	NESTA DTL-B	183
26571	SHADE B/F-W 2M	101	26751	NESTA DTL-C	183

INDEKS WEDŁUG KODÓW

INDEX BY CODES

26752	NESTA DTL-C/M	183	27116	TP SLIM LED 50W-NW	253
26753	ALREN DTL-W	181	27117	TP SLIM TW LED 40W-NW	253
26754	ALREN DTL-B	181	27118	TP SLIM TW LED 50W-NW	253
26755	ALREN DTL-C	181	27155	HB PRO LED HI 100W-NW	296
26756	ALREN DTL-C/M	181	27156	HB PRO LED HI 150W-NW	296
26757	ALREN R DTL-B	180	27157	HB PRO LED HI 200W-NW	296
26758	ALREN R DTL-W	180	27210	CARSA V2LED 12W-NW-SN	285
26760	DUN HI 8W E14-WW	62	27211	CARSA V2LED 18W-NW-SN	285
26761	DUN HI 8W E14-NW	62	27212	KANTI V2LED 12W-NW-SN	285
26762	BILO HI 8W E14-WW	68	27213	KANTI V2LED 18W-NW-SN	285
26763	BILO HI 8W E14-NW	68	27216	KATRO V2LED 24W-NW-SN	283
26764	BILO HI 8W E27-WW	68	27217	KATRO V2LED 6W-NW-SN	283
26765	BILO HI 8W E27-NW	68	27220	ROUND A V2LED24W-NW-SN	282
26770	AVAR 6060 40W-NW	243	27221	ROUND A V2LED6W-NW-SN	282
26771	AVAR 6060 40W-CW	243	27230	CEMIN DTL-GR	178
26772	AVAR 6060 40W-WW	243	27270	IQ-LED A60 5,5W-WW	46
26773	AVAR 6262 40W-NW	243	27271	IQ-LED A60 5,5W-NW	46
26774	AVAR 6262 40W-WW	243	27272	IQ-LED A60 5,5W-CW	46
26791	ALOR DSO-B	196	27273	IQ-LED A60 9W-WW	46
26796	ALOR DTO-B	196	27274	IQ-LED A60 9W-NW	46
26810	POWELED P 12V 30W	345	27275	IQ-LED A60 9W-CW	46
26811	POWELED P 12V 60W	345	27276	IQ-LED A60 10,5W-WW	46
26820	SENTO	340	27277	IQ-LED A60 10,5W-NW	46
26821	SENZO	340	27278	IQ-LED A60 10,5W-CW	46
26828	STOBI ES 50-B	125	27279	IQ-LED A60 14W-WW	46
26829	STOBI ES 50-W	125	27280	IQ-LED A60 14W-NW	46
26830	STOBI DLP 50-B	126	27281	IQ-LED A60 14W-CW	46
26831	STOBI DLP 50-W	126	27282	IQ-LEDDIM A60 5,5W-WW	48
26832	STOBI DLP 250-B	126	27283	IQ-LEDDIM A60 5,5W-NW	48
26833	STOBI DLP 250-W	126	27284	IQ-LEDDIM A60 5,5W-CW	48
26834	STOBI DLP 350-B	126	27285	IQ-LEDDIM A60 8,5W-WW	48
26835	STOBI DLP 350-W	126	27286	IQ-LEDDIM A60 8,5W-NW	48
26836	STOBI DLP 450-B	126	27287	IQ-LEDDIM A60 8,5W-CW	48
26837	STOBI DLP 450-W	126	27288	IQ-LEDDIM A6012,5W-WW	48
26838	STOBI ES 250-B	125	27289	IQ-LEDDIM A6012,5W-NW	48
26839	STOBI ES 250-W	125	27290	IQ-LEDDIM A6012,5W-CW	48
26840	APUS LED W-WW	210	27291	IQ-LEDDIM A60 15W-WW	48
26841	APUS LED W-CW	210	27292	IQ-LEDDIM A60 15W-NW	48
26842	TERRA LED W-WW	211	27293	IQ-LEDDIM A60 15W-CW	48
26843	TERRA LED W-CW	211	27294	IQ-LED C37E14 5,5W-WW	58
26846	TERRA LED AC B-NW	211	27295	IQ-LED C37E14 5,5W-NW	58
26847	TERRA LED AC B-WW	211	27296	IQ-LED C37E14 5,5W-CW	58
26848	TERRA LED B-NW	211	27297	IQ-LED C37E14 7,5W-WW	58
26849	TERRA LED B-WW	211	27298	IQ-LED C37E14 7,5W-NW	58
26960	MEBA 4LED 2X60 PS	257	27299	IQ-LED C37E14 7,5W-CW	58
26961	MEBA 4LED 2X120 PS	257	27300	IQ-LED G45E14 5,5W-WW	64
26963	MEBA 4LED 2X60 OP PS	257	27301	IQ-LED G45E14 5,5W-NW	64
26964	MEBA 4LED 2X120 OP PS	257	27302	IQ-LED G45E14 5,5W-CW	64
26965	MEBA 4LED 2X150 OP PS	257	27303	IQ-LED G45E27 5,5W-WW	64
26980	VARSO LED 18W-NW-L-SE	262	27304	IQ-LED G45E27 5,5W-NW	64
26981	VARSO LED 18W-NW-O-SE	262	27305	IQ-LED G45E27 5,5W-CW	64
26983	VARSO LED 24W-NW-L-SE	262	27306	IQ-LED G45E14 7,5W-WW	64
26984	VARSO LED 24W-NW-O-SE	262	27307	IQ-LED G45E14 7,5W-NW	64
26985	VARSO HI 36W-NW-O-SE	262	27308	IQ-LED G45E14 7,5W-CW	64
26986	VARSO HI 36W-NW-L-SE	262	27309	IQ-LED G45E27 7,5W-WW	64
27000	ETISSA D20 GR	122	27310	IQ-LED G45E27 7,5W-NW	64
27001	OGIVA D35 GR	122	27311	IQ-LED G45E27 7,5W-CW	64
27020	ASIL G9 W-B	204	27312	IQ-LED A67 17,5W-WW	47
27021	ASIL G9 W-GR	204	27313	IQ-LED A67 17,5W-NW	47
27022	ASIL G9 W-W	204	27314	IQ-LED A67 17,5W-CW	47
27030	ALGO GU10 CL-B	138	27315	IQ-LED A67 20W-WW	47
27032	ALGO GU10 CL-W	138	27316	IQ-LED A67 20W-NW	47
27033	ALGO GU10 CO-B	138	27317	IQ-LED A67 20W-CW	47
27035	ALGO GU10 CO-W	138	27320	SPAG L B/G	165
27036	ALGO GU10 PL-B	123	27321	SPAG L W/G	165
27039	ALGO GU10 PO-B	123	27322	SPAG S B/G	165
27050	iTECH M2 302 AT	362	27323	SPAG S W/G	165
27051	ZEST.MONT.PXT ONTEC G	366	27324	SPAG C B/G	165
27090	ANTOS LED 10W-NW B	289	27325	SPAG C W/G	165
27091	ANTOS LED 20W-NW B	289	27326	SPAG D B/G	165
27092	ANTOS LED 30W-NW B	289	27327	SPAG D W/G	165
27093	ANTOS LED 50W-NW B	289	27330	STREET LED 4000 NW	292
27094	ANTOS LED 10W-NW-SE B	289	27331	STREET LED 8000 NW	292
27095	ANTOS LED 20W-NW-SE B	289	27332	STREET LED 12000 NW	292
27096	ANTOS LED 30W-NW-SE B	289	27333	STREET LED ADTR 15D	292
27097	ANTOS LED 50W-NW-SE B	289	27360	ISTI LED W	226
27115	TP SLIM LED 40W-NW	253	27361	ISTI LED B	226

INDEKS WEDŁUG KODÓW

INDEX BY CODES

27370	APUS LED PIR WW	210	27601	HERON LED W	231
27371	APUS LED PIR CW	210	27610	ADTR 6060 SR	239, 241
27372	TERRA LED PIR WW	211	27611	ADTR 12030 W	239, 241
27373	TERRA LED PIR CW	211	27612	ADTR 12030 SR	239, 241
27374	SABIK LED PIR WW	213	27613	ADTR 6060 W	239, 241
27375	SABIK LED PIR CW	213	27614	ADTR 12030 B	239, 241
27376	TERRA MINI LED B-NW	211	27615	ADTR 6060 B	239, 241
27377	TERRA MINI LED B-WW	211	27622	iTECHM5105MATW	362
27381	iTECH M5 105 M ST W	362	27623	iTECHM5105MCOLDATW	362
27394	ONTEC G E1B 101 M ST W	366	27635	iTECHF1302MATW	362
27395	ONTEC G E1B 301M ST W	366	27638	iTECHF2105MATW	362
27397	ZEST, MONT, FLAGI	364	27646	ONTECSM2102MATW	363
27399	ZEST.MONT.PYT ONTEC R	365	27648	ONTECSM5105MATW	363
27400	VIP 136 ST 2	367	27649	ONTECSM5305MATW	363
27401	VIP 158 ST 2	367	27652	ONTECSC1302MATW	363
27480	PICTO ONTEC G TMP1	368	27664	ONTECSW1302MATW	363
27481	PICTO ONTEC G TMP2	368	27673	ONTECCM2302MATW	366
27482	PICTO ONTEC G TMP5	368	27731	OntecRM2302MATW	365
27483	PICTO ONTEC G TMP6	368	27732	OntecRMS105MATW	365
27484	PICTO ONTEC G TMP7	368	27739	OntecRC1302MATW	365
27485	PICTO ONTEC G TMP8	368	27750	ONTECGE1B101MATW	366
27486	PICTO ONTEC G TMP9	368	27763	OSŁONA.ŚCIEN.ONT.S008	363
27487	PICTO ONTEC G TMP10	368	27764	OSŁ.SUF.ONTEC S009	363
27488	PICTO ONTEC G TMP11	368	27800	ELNIS S W	168
27489	PICTO ONTEC G TMP12	368	27801	ELNIS S W/A	168
27490	PICTO ONTEC G TMP13	368	27802	ELNIS S A/W	168
27491	PICTO ONTEC G TMP14	368	27803	ELNIS S A/C	168
27492	PICTO ONTEC G TMP15	368	27804	ELNIS L W	169
27493	PICTO ONTEC G TMP16	368	27805	ELNIS L W/A	169
27494	PICTO ONTEC G TMP17	368	27806	ELNIS L W/C	169
27495	PICTO ONTEC G TMP18	368	27807	ELNIS L A/W	169
27497	PICTO ONTEC G TMP22	368	27808	ELNIS L A/C	169
27498	PICTO ONTEC G TMP23	368	27809	ELNIS L A	169
27499	PICTO ONTEC G TMP67	368	27810	ELNIS L B/G	169
27500	PICTO ONTEC G TMP68	368	27811	ELNIS L C/W	169
27501	PICTO ONTEC G TMP50	368	27812	ELNIS L C/A	169
27502	PICTO ONTEC G TMP51	368	27827	ONTECSM2102MSTW	363
27503	PICTO ONTEC S TMP1	369	27828	ONTECSM2302MSTW	363
27504	PICTO ONTEC S TMP2	369	27829	ONTECSM5105MSTW	363
27505	PICTO ONTEC S TMP5	369	27830	ONTECSM5305MSTW	363
27506	PICTO ONTEC S TMP6	369	27831	ONTECSM2302MCOLDSTW	363
27507	PICTO ONTEC S TMP7	369	27839	ONTECCM2302MSTW	366
27508	PICTO ONTEC S TMP8	369	27850	OntecRMS105MSTW	365
27509	PICTO ONTEC S TMP9	369	27880	ONTECSC1302MSTW	363
27510	PICTO ONTEC S TMP10	369	27892	ONTECSW1302MSTW	363
27511	PICTO ONTEC S TMP11	369	27920	ONTECSM1301MSTWIP44	363
27512	PICTO ONTEC S TMP12	369	27946	ZESTAW OG-M.WPUSZCZB	366
27513	PICTO ONTEC S TMP13	369	27947	ZESTAW OG-M.WPUSZCZG	366
27514	PICTO ONTEC S TMP14	369	27948	ZESTAW OR-M.WPUSZCZB	365
27515	PICTO ONTEC S TMP15	369	27949	ZESTAW OR-M.WPUSZCZG	365
27516	PICTO ONTEC S TMP16	369	27980	SARI LED B-CH	227
27517	PICTO ONTEC S TMP17	369	27981	SARI LED B-SR	227
27518	PICTO ONTEC S TMP18	369	27982	SARI LED W-SR	227
27519	PICTO ONTEC S TMP21	369	28000	BRAVO P 36W6060NW W	238
27520	PICTO ONTEC S TMP22	369	28002	BRAVO PU36W6060NW W	238
27521	PICTO ONTEC S TMP23	369	28003	BRAVO PU36W6060NW SR	238
27522	PICTO ONTEC S TMP67	369	28006	BRAVO P 36W6060CW W	238
27523	PICTO ONTEC S TMP68	369	28008	BRAVO P 45W6060NW W	238
27524	PICTO ONTEC S TMP50	369	28010	BRAVO S 40W6060NW W	240
27525	PICTO ONTEC S TMP51	369	28011	BRAVO S 40W6060NW SR	240
27531	PESSA LED IP44 9W-NW	205	28013	BRAVO SU40W6060NW SR	240
27533	PESSA LED IP44 17W-NW	205	28018	BRAVO S 50W6060NW W	240
27556	SOLA LED AC B-NW	214	28019	BRAVO S 50W6060NW SR	240
27557	SOLA LED AC B-WW	214	28020	BRAVO P 36W12030NW W	238
27558	SOLA LED B-NW	214	28022	BRAVO S 40W12030NW W	240
27559	SOLA LED B-WW	214	28024	BRAVO PU36W6262NW W	238
27570	RITI GU10 WG	135	28025	BRAVO DRIVER 36W	239
27571	RITI GU10 B/G	135	28026	BRAVO DRIVER 40W	241
27574	RITI REF SR	135	28027	BRAVO DRIVER 45W	239
27575	MINI RITI GU10 B/G	158	28028	BRAVO DRIVER 50W	241
27576	MINI RITI GU10 W/G	158	28029	BRAVO DRIVER 28W	239
27577	MINI RITI GU10 B/W	158	28270	KRALA LED 45W NW	252
27578	MINI RITI GU10 B/B	158	28271	KRALA PLUG-1M	252
27590	LINUS LED 4W-NW	218	28272	KRALA PR-I	252
27591	LINUS LED 7W-NW	218	28273	KRALA PP-1M	252
27579	MINI RITI GU10 W/W	158	28274	KRALA PP-0,35M	252
27600	HERON LED B	231	28275	KRALA CORD-2M	252

INDEKS WEDŁUG KODÓW

INDEX BY CODES

28276	KRALA SENSOR	252	28946	KATRO V2LED 6W-NW-W	283
28463	TORIM DLP-250 B-W	139	28947	KATRO V2LED 6W-WW-W	283
28490	FL MASTER LED 100W-NW	286	28948	CARSA V2LED 12W-NW-W	285
28491	FL MASTER LED 140W-NW	286	28949	CARSA V2LED 18W-NW-W	285
28492	FL MASTER LED 220W-NW	286	28950	KANTI V2LED 12W-NW-W	285
28500	BRAVO S/P GRIP 60-62	239, 241	28951	KANTI V2LED 18W-NW-W	285
28501	BRAVO S/P GRIP 12030	239, 241	28990	REKA LED EL 7W-L-GR	301
28502	CLIPS BRAVO S/P 60-62	239, 241	28991	REKA LED EL 7W-O-GR	301
28503	CLIPS BRAVO S/P 12030	239, 241	28992	REKA LED EL 7W-L-W	301
28504	SPN BRAVO S/P 60-62	239, 241	28993	REKA LED EL 7W-O-W	301
28505	SPN BRAVO S/P 12030	239, 241	29000	GORI EL 135 D	317
28507	BRAVO DALI SET 45W	239	29001	GORI EL 235 D	317
28508	BRAVO DALI SET 36W	239	29002	GORI 50	317
28512	AVAR DALI SET 40W	243	29003	GORI 80	317
28520	FLM LED 100W-NW-60D	287	29010	VADRA 16L-UP	318
28521	FLM LED100W-NW110/150	287	29011	VADRA 21L-UP SE	318
28522	FLM LED 140W-NW-60D	287	29012	VADRA 50	318
28523	FLM LED140W-NW110/150	287	29013	VADRA 80	318
28524	FLM LED 220W-NW-60D	287	29030	IMINES DSL-W	166
28525	FLM LED220W-NW110/150	287	29031	IMINES DSO-W	166
28530	HB MASTER LED 100W	294	29040	LUNATI GU10 W	131
28531	HB MASTER LED 150W	294	29041	LUNATI GU10 B	131
28532	HB MASTER LED 200W	294	29060	SHARK N EL-60	274
28533	HBM REF ALU100/150W	293	29070	PORTOS LED	267
28534	HBM REF ALU200W	293	29100	EVELI EL-10	152
28535	HBM REF PC100/150W	293	29101	EVELI EL-2I	152
28536	HBM REF PC200W	293	29102	EVELI EL-30	152
28537	HBM LENS 60D 100/150W	293	29103	EVELI EL-4I	152
28538	HBM LENS 90D 100/150W	293	29110	MILENO EL-10 B-AG	150
28539	HBM PC 100D 100/150W	293	29111	MILENO EL-10 ASR-AN	150
28540	HBM LENS 60D 200W	293	29112	MILENO EL-30 B-AG	150
28541	HBM LENS 90D 200W	293	29113	MILENO EL-30 ASR-AN	150
28542	HBM PC 100D 200W	293	29114	MILENO EL-2I B-AG	150
28543	HBM BRACKET 100/150W	293	29115	MILENO EL-2I ASR-AN	150
28544	HBM BRACKET 200W	293	29116	MILENO EL-3I B-AG	150
28545	HBM GRID 100/150W	293	29117	MILENO EL-3I ASR-AN	150
28546	HBM GRID 200W	293	29118	MILENO EL-4I B-AG	150
28551	BRAVO PU28W3060NW W	238	29119	MILENO EL-4I ASR-AN	150
28700	BONIS DSO-W	167	29120	LAURIN EL-10 W	144
28701	BONIS DSO-C	167	29121	LAURIN EL-10 B	144
28702	BONIS DSL-W	167	29122	LAURIN EL-2I W	144
28703	BONIS DSL-C	167	29123	LAURIN EL-2I B	144
28721	BIGGE LED 42W-NW-O	266	29124	LAURIN EL-3I W	144
28723	BIGGE LED 42W-NW-L	266	29125	LAURIN EL-3I B	144
28760	ENALI EL-10 W	148	29126	LAURIN EL-30 W	144
28761	ENALI EL-10 B	148	29127	LAURIN EL-30 B	144
28762	ENALI EL-2I W	148	29128	LAURIN EL-40 W	144
28763	ENALI EL-2I B	148	29129	LAURIN EL-40 B	144
28764	ENALI EL-30 W	148	29130	SIMEN DSL W/W/B	163
28765	ENALI EL-30 B	148	29131	SIMEN DSL B/W/B	163
28766	ENALI EL-3I W	148	29132	SIMEN DSL SR/B/B	163
28767	ENALI EL-3I B	148	29133	SIMEN DSL W/W/G	163
28768	ENALI EL-4I W	148	29134	SIMEN DSL B/G/B	163
28769	ENALI EL-4I B	148	29135	SIMEN DSL W/G/W	163
28780	MINI GORD DLP-50-W	159	29136	SIMEN DSL B/B/G	163
28781	MINI GORD DLP-50-B	159	29137	SIMEN DSO B/G	162
28782	MINI BORD DLP-50-W	159	29138	SIMEN DSO B/W	162
28783	MINI BORD DLP-50-B	159	29139	SIMEN DSO W/B	162
28790	FOLLO LED W	228	29140	SIMEN DSO WG	162
28791	FOLLO LED B	228	29141	SIMEN DSO G/B	162
28830	DimGO 105	347	29142	SIMEN DSO G/W	162
28930	ROUNDA V2LED12W-NW-SR	282	29143	SIMEN DSO SR/B	162
28931	ROUNDA V2LED12W-NW-W	282	29160	ORTE LED 18W-NW-O	264
28932	ROUNDA V2LED12W-WW-W	282	29161	ORTE LED 24W-NW-O	264
28933	ROUNDA V2LED18W-NW-SR	282	29162	ORTE LED 18W-NW-O-SE	264
28934	ROUNDA V2LED18W-NW-W	282	29163	ORTE LED 24W-NW-O-SE	264
28935	ROUNDA V2LED18W-WW-W	282	29170	INVO OP EL-53-L-GR	312
28936	ROUNDA V2LED24W-NW-W	282	29171	INVO OP 47-L-GR	312
28937	ROUNDA V2LED6W-NW-W	282	29172	INVO OP 77-L-GR	312
28938	ROUNDA V2LED6W-NW-SR	282	29173	INVO OP 107-L-GR	312
28939	KATRO V2LED 12W-NW-SR	283	29174	INVO TR EL-53-O-GR	313
28940	KATRO V2LED 12W-NW-W	283	29175	INVO TR 47-O-GR	313
28941	KATRO V2LED 12W-WW-W	283	29176	INVO TR 77-O-GR	313
28942	KATRO V2LED 18W-NW-SR	283	29177	INVO TR 107-O-GR	313
28943	KATRO V2LED 18W-NW-W	283	29210	MERA LED 5W NW	216
28944	KATRO V2LED 18W-WW-W	283	29211	MERA LED 10W NW	216
28945	KATRO V2LED 24W-NW-W	283	29212	MERA LED 15W NW	216

29213	MERA LED 20W NW	216	29641	XLED C35T 2,5W-SW	57
29214	MERA LED PP	216	29642	XLED A60 5W-SW	57
29230	LUNIO DTO-W	166	29643	XLED G95 5W-SW	57
29235	GOVIK D50-W	160	29644	XLED G95 5W-SW	57
29236	GOVIK D50-B	160	29645	XLED C35T 2,5W-SW	57
29237	GOVIK-ST D50-B	160	29646	XLED G125 5W-SW	57
29238	GOVIK-ST D50-W	160	29646	XLED C35E27 6W-WW-M	60
29241	SANI IP44 D50-W	131	29647	XLED C35E27 6W-NW-M	60
29300	MODv2 12W LED-WW	87	29803	IQ-LED GU10 5W-WW	69
29301	MODv2 12W LED-NW	87	29804	IQ-LED GU10 5W-NW	69
29302	MODv2 19W LED-WW	87	29805	IQ-LED GU10 5W-CW	69
29303	MODv2 19W LED-NW	87	29806	IQ-LED GU10 6,5WS3-WW	69
29310	CHIRO GU10 DTO-W	164	29807	IQ-LED GU10 6,5WS3-NW	69
29311	CHIRO GU10 DTO-B	164	29808	IQ-LED GU10 6,5WS3-CW	69
29312	CHIRO GU10 DTL-W	164	29809	IQ-LED GU10 6,5W-WW	69
29313	CHIRO GU10 DTL-B	164	29810	IQ-LED GU10 6,5W-NW	69
29580	AREL LED DO 6W-NW	280	29811	IQ-LED GU10 6,5W-CW	69
29581	AREL LED DO 6W-WW	280	29812	IQ-LEDIM GU10 6,5W-WW	70
29582	AREL LED DL 6W-NW	280	29813	IQ-LEDIM GU10 6,5W-NW	70
29583	AREL LED DL 6W-WW	280	29814	IQ-LEDIM GU10 6,5W-CW	70
29584	AREL LED DO 10W-NW	280	29832	LART EL-160-GR	298
29585	AREL LED DO 10W-WW	280	29833	LART EL-260-GR	298
29586	AREL LED DL 10W-NW	280	29850	SABIK LED AC B-NW	213
29587	AREL LED DL 10W-WW	280	29851	SABIK LED AC B-WW	213
29588	AREL LED DO 14W-NW	280	29852	SABIK LED B-NW	213
29589	AREL LED DO 14W-WW	280	29853	SABIK LED B-WW	213
29590	AREL LED DL 14W-NW	280	29854	SABIK MINI LED B-NW	213
29591	AREL LED DL 14W-WW	280	29855	SABIK MINI LED B-WW	213
29592	AREL LED DO 20W-NW	280	29856	APUS LED PIR B-NW	210
29593	AREL LED DO 20W-WW	280	29857	APUS LED PIR B-WW	210
29594	AREL LED DL 20W-NW	280	29858	SABIK LED PIR B-NW	213
29595	AREL LED DL 20W-WW	280	29859	SABIK LED PIR B-WW	213
29596	AREL LED DO 25W-NW	280	29860	TERRA LED PIR B-NW	211
29597	AREL LED DO 25W-WW	280	29861	TERRA LED PIR B-WW	211
29598	AREL LED DL 25W-NW	280	29050	MERSA 300-B/M	140
29599	AREL LED DL 25W-WW	280	29051	MERSA 380-B/M	140
29600	XLED A60 4,5W-WW	49	29071	PORTOS LED SE	267
29601	XLED A60 7W-WW	49	29200	JASMIN 370-A	141
29602	XLED A60 7W-NW	49	29220	STATO 30W	290
29603	XLED A60 7W-CW	49	29221	STATO 50W	290
29604	XLED A60 8W-WW	49	29240	SANI IP44 D50-B	131
29605	XLED A60 10W-WW	49	29250	FORRO LED EL 8W-GR	302
29606	XLED A60 10W-NW	49	29251	FORRO LED EL 8W-W	302
29607	XLED A60 4,5W-WW-M	51	29260	BISO LED EL 8W-GR	302
29608	XLED A60 4,5W-NW-M	51	29261	BISO LED EL 8W-W	302
29609	XLED A60 7W-WW-M	51	29270	GARTO LED EL 8W-GR	303
29610	XLED A60 7W-NW-M	51	29271	GARTO LED EL 8W-W	303
29611	XLED A60 7W-CW-M	51	29822	BLINGO R 38W 6060 NW	236
29612	XLED A60 8W-WW-M	51	29823	BLINGO R 38W 12030 NW	236
29613	XLED A60 8W-NW-M	51	29824	BLINGO RU 38W 6060 NW	236
29614	XLED A60 8W-CW-M	51	29825	BLINGO TU 48W 6060 NW	236
29615	XLED A60 10W-WW-M	51	29826	CLIPS BLINGO RT	237
29616	XLED A60 10W-NW-M	51	29840	ADTR 3060 W	239
29617	XLED C35E14 2,5W-WW	59	29841	ADTR 3060 SR	239
29618	XLED C35E14 4,5W-WW	59	29842	ADTR 3060 B	239
29619	XLED C35E14 4,5W-NW	59	29843	ADTR-H 6060 W	237
29620	XLED C35E14 4,5W-WW-M	60	29844	ADTR-H 6060 SR	237
29621	XLED C35E14 4,5W-NW-M	60	29845	ADTR-H 6060 B	237
29622	XLED C35E14 6W-WW-M	60	32480	SEORA LED AC B-NW	212
29623	XLED C35E14 6W-NW-M	60	32481	SEORA LED AC B-WW	212
29624	XLED G45 E14 4,5W-WW	65	32482	SEORA LED B-NW	212
29625	XLED G45E27 4,5W-WW	65	32483	SEORA LED B-WW	212
29626	XLED G45E14 4,5W-WW-M	66	32484	SEORA LED AC NW	212
29627	XLED G45E14 4,5W-NW-M	66	32485	SEORA LED AC WW	212
29628	XLED G45E14 6W-WW-M	66	32486	SEORA LED NW	212
29629	XLED G45E14 6W-NW-M	66	32487	SEORA LED WW	212
29630	XLED G45E27 4,5W-WW-M	66	32491	SOLA LED NW	214
29631	XLED G45E27 4,5W-NW-M	66	32494	MEFIS LED W-WW	215
29632	XLED G45E27 6W-WW-M	66	32495	MEFIS LED W-NW	215
29633	XLED G45E27 6W-NW-M	66	32496	MEFIS LED B-WW	215
29634	XLEDA60 7W-WW-STEPPDIM	53	32497	MEFIS LED B-NW	215
29635	XLEDA60 7W-NW-STEPPDIM	53	32498	MEFIS LED GR-WW	215
29636	XLED A60 7W-STEP CCT	53	32499	MEFIS LED GR-NW	215
29637	XLED ST64 7W-WW	56	32500	MARIN CT-S80-W	193
29638	XLED G125 7W-WW	56	32501	MARIN CT-S80-B	193
29639	XLED A70 15W-WW	50	32520	TONIL LED B *OPRAWA LED	203
29640	XLED A70 15W-NW	50	32521	TONIL LED W *OPRAWA LED	203

INDEKS WEDŁUG KODÓW

INDEX BY CODES

32530	DROMI LED EL-1 7W-GR	315	33192	HBPH LENS 60D 200W	295
32531	DROMI LED EL-2 13W-GR	315	33193	HBPH LENS 120D 100W	295
32532	DROMI LED 50 7W-GR	315	33194	HBPH LENS 120D 150W	295
32533	DROMI LED 80 7W-GR	315	33195	HBPH LENS 120D 200W	295
32620	BRASO LED 28W 6060 NW	242	33196	HBPH GRID 100W	295
32946	BENO 24W NW-L-SEW	260	33197	HBPH GRID 150W	295
32920	RAPID E27-NW	54	33198	HBPH GRID 200W	295
32921	RAPID E27-WW	54	33200	ANTEM LED 10W-NW B	288
32922	RAPID PRO E27-NW	54	33201	ANTEM LED 20W-NW B	288
32923	RAPID PRO E27-WW	54	33202	ANTEM LED 30W-NW B	288
32924	RAPID MAXX E27-NW	54	33203	ANTEM LED 50W-NW B	288
32925	RAPID MAXX E27-WW	54	33204	ANTEM LED 100W-NW B	288
32926	RAPID HI E27-NW	54	33205	ANTEM LED 10W-NW-SE B	288
32927	RAPID HI E27-WW	54	33206	ANTEM LED 20W-NW-SE B	288
32930	MATEO ES DLP-150-B	276	33207	ANTEM LED 30W-NW-SE B	288
32931	MATEO ES DLP-150-W	276	33208	ANTEM LED 50W-NW-SE B	288
32932	MATEO ES DLP-250-B	276	33210	T8 LED GLASSv4 9W-NW	85
32933	MATEO ES DLP-250-W	276	33211	T8 LED GLASSv4 9W-CW	85
32940	BENO 18W NW-O-W	260	33212	T8 LED GLASSv4 18W-NW	85
32941	BENO 18W NW-O-GR	260	33213	T8 LED GLASSv4 18W-CW	85
32942	BENO 18W NW-L-W	260	33214	T8 LED GLASSv4 24W-NW	85
32943	BENO 18W NW-L-GR	260	33215	T8 LED GLASSv4 24W-CW	85
32944	BENO 18W NW-O-SE W	260	33220	DAIBO LED T-B	232
32945	BENO 18W NW-O-SE GR	260	33221	DAIBO LED T-W	232
32946	BENO 18W NW-L-SE W	260	33230	TEAR N TR 1M-W	330
32947	BENO 18W NW-L-SE GR	260	33231	TEAR N TR 1M-B	330
32950	BLURRO GU10 CO-B	130	33232	TEAR N TR 2M-W	330
32951	BLURRO GU10 CO-W	130	33233	TEAR N TR 2M-B	330
32952	BLURRO 2xGU10 CO-B	130	33234	TEAR N PCON R-W	330
32953	BLURRO 2xGU10 CO-W	130	33235	TEAR N PCON R-B	330
33070	REXAR LED W	224	33236	TEAR N EPLUG W	330
33071	REXAR LED B	224	33237	TEAR N EPLUG B	330
33080	REMI LED GU10-NW	70	33238	TEAR N ICON-I W	330
33081	REMI LED GU10-WW	70	33239	TEAR N ICON-I B	330
33090	SEMPRA EL-11 W-SR	146	33240	TEAR N CON-I W	331
33091	SEMPRA EL-11 B-SR	146	33241	TEAR N CON-I B	331
33092	SEMPRA EL-21 W-SR	146	33242	TEAR N CON-L RL-W	331
33093	SEMPRA EL-21 B-SR	146	33243	TEAR N CON-L RL-B	331
33094	SEMPRA EL-31 W-SR	146	33244	TEAR N CON-L LR-W	331
33095	SEMPRA EL-31 B-SR	146	33245	TEAR N CON-L LR-B	331
33096	SEMPRA EL-41 W-SR	146	33246	TEAR N CON-X W	330
33097	SEMPRA EL-41 B-SR	146	33247	TEAR N CON-X B	330
33100	XLED A60 B22 7W-WW	52	33248	TEAR N CON-T RRL-W	331
33101	XLED A60 B22 7W-CW	52	33249	TEAR N CON-T RRL-B	331
33102	XLED A60 B22 7W-WW-M	52	33250	TEAR N CON-T RLL-W	330
33103	XLED A60 B22 7W-CW-M	52	33251	TEAR N CON-T RLL-B	330
33104	XLED A60 B22 8W-WW	52	33252	TEAR N CON-I FLEX W	331
33105	XLED A60 B22 8W-WW-M	52	33253	TEAR N CON-I FLEX B	331
33106	XLED A60 B22 8W-CW-M	52	33254	TEAR N SCLAMP W	331
33107	XLED A60 B22 10W-CW	52	33255	TEAR N SCLAMP B	330
33108	XLED A60 B22 10W-WW-M	52	33256	TEAR N SKIT W	330
33109	XLED A60 B22 10W-CW-M	52	33257	TEAR N SKIT B	330
33120	FLINI IP44 DSL-B	190	33260	TEAR N PCON L-W	330
33121	FLINI IP44 DSL-W	190	33261	TEAR N PCON L-B	330
33122	FLINI IP44 DSO-B	190	33262	TEAR N CON-T LRR-W	330
33123	FLINI IP44 DSO-W	190	33263	TEAR N CON-T LRR-B	331
33130	ATL1 18W-930-S6-W	326	33264	TEAR N CON-T LLR-W	331
33131	ATL1 18W-930-S6-B	326	33265	TEAR N CON-T LLR-B	331
33132	ATL1 18W-940-S6-W	326	33300	LCOB 9W/M 12IP00-WW	92
33133	ATL1 18W-940-S6-B	326	33301	LCOB 9W/M 12IP00-NW	92
33134	ATL1 30W-930-S6-W	326	33302	L60 11W/M 12 IP00-WW	90
33135	ATL1 30W-930-S6-B	326	33303	L60 11W/M 12 IP00-NW	90
33136	ATL1 30W-940-S6-W	326	33304	L60 11W/M 12 IP00-CW	90
33137	ATL1 30W-940-S6-B	326	33305	L60B 11W/M 12 IP00-WW	90
33138	ATL2 GU10-W	328	33306	L60B 11W/M 12 IP00-NW	90
33139	ATL2 GU10-B	328	33307	L60B 11W/M 12 IP00-CW	90
33140	REF ATL1-18W-S15	327	33308	L60 11W/M 12 IP65-WW	90
33141	REF ATL1-18W-S36	327	33309	L60 11W/M 12 IP65-NW	90
33142	REF ATL1-30W-S15	327	33310	L60 11W/M 12 IP65-CW	90
33143	REF ATL1-30W-S36	327	33311	L120 16W/M 24 IP00-WW	91
33160	AJAS DSO-B	161	33312	L120 16W/M 24 IP00-NW	91
33161	AJAS DSO-W	161	33313	L120 16W/M 24 IP00-CW	91
33170	TP STRONG LED 48W-NW	250	33314	L120 16W/M 24 IP65-WW	91
33171	TP STRONG LED 75W-NW	250	33315	L120 16W/M 24 IP65-NW	91
33180	BLINGO P 38W 6060 NW	236	33316	L120 16W/M 24 IP65-CW	91
33190	HBPH LENS 60D 100W	295	33317	L120 16W/M 12 IP00CCT	93
33191	HBPH LENS 60D 150W	295	33318	L48 9W/M 24 IP00-RGBW	95

33319	L48 9W\W 24 IP65-RGBW	95
33320	ERINUS LED L W-WW	208
33321	ERINUS LED L W-NW	208
33322	ERINUS LED O W-WW	208
33323	ERINUS LED O W-NW	208
33324	ERINUS LED LL W-WW	208
33325	ERINUS LED LL W-NW	208
33326	ERINUS LED L GR-WW	208
33327	ERINUS LED L GR-NW	208
33328	ERINUS LED O GR-WW	208
33329	ERINUS LED O GR-NW	208
33330	ERINUS LED LL GR-WW	208
33331	ERINUS LED LL GR-NW	208
33332	ERINUS LED L B-WW	208
33333	ERINUS LED L B-NW	208
33334	ERINUS LED O B-WW	208
33335	ERINUS LED O B-NW	208
33336	ERINUS LED LL B-WW	208
33337	ERINUS LED LL B-NW	208
33340	BENO 24W NW-O-W	260
33341	BENO 24W NW-O-GR	260
33342	BENO 24W NW-L-W	260
33343	BENO 24W NW-L-GR	260
33344	BENO 24W NW-O-SE W	260
33345	BENO 24W NW-O-SE GR	260
33347	BENO 24W NW-L-SE GR	260
70480	BL-118H-EVG	348
70481	BL-136H-EVG	348
70482	BL-158H-EVG	348
70483	BL-218H-EVG	348
70484	BL-236H-EVG	348
70485	BL-258H-EVG	348
70486	BL-418H-EVG	348
70513	GP-2	355
70514	NANO W-1	356
70522	MILO 7040T	271
70523	MILO 7040T/P	271
70524	HERMI 7063NB	272
70525	INES 7061N	271
70710	TIVA 1130 DDR/ML-SN	142
70711	TIVA 1130 DDR/ML-DB	142
70717	TIVA 1130 DDR/ML-OL	142
70720	TIVA 1030 SDR/ML-SN	142
70721	TIVA 1030 SDR/ML-DB	142
70727	TIVA 1030 SDR/ML-OL	142
70740	TIVA 1030 1/2DR/ML-SN	142
70741	TIVA 1030 1/2DR/ML-DB	142
70747	TIVA 1030 1/2DR/ML-OL	142
70761	ARDEA 1030 SG/ML-SR	143
70782	ARDEA 1130 D/ML-BI	143
70784	ARDEA 1030 S/ML-BI	143
70786	ARDEA 1030 M/ML-BI	143
70788	ARDEA 1030 1/2/ML-BI	143
70910	CYKLON EOL100	351
70911	CYKLON EOL100B	351
70915	CYKLON EOL120	351
70916	CYKLON EOL120B	351
70920	CYKLON EOL150	351
70921	CYKLON EOL150B	351
70926	TWISTER AOL100B	350
70936	CYKLON EOL100HT	351
70937	CYKLON EOL100P	351
70938	CYKLON EOL100T	351
70941	CYKLON EOL120HT	351
70942	CYKLON EOL120P	351
70943	CYKLON EOL120T	351
70947	CYKLON EOL150P	351
70948	CYKLON EOL150T	351
70953	TWISTER AOL100T	350
70956	TWISTER AOL120B	350
70960	TWISTER AOL120T	350
70961	WIR ZL100	349
70962	WIR ZL120	349
72109	HLD R-GX5,3	360
72333	CLP-REGISVPT	245
72369	BR-GZ10	358

KANLUX SA

ul. Objazdowa 1 - 3, 41 - 922 Radzionków
POLSKA
tel. +48 32/388 74 00
fax +48 32/388 74 99
e-mail: kanlux@kanlux.pl

KANLUX UK DISTRIBUTION

mob. 077 2524 9456
mob. 074 6679 1303
e-mail: kanlux.uk@kanlux.com

KANLUX S.R.O.

Sadová 618, 738 01 Frýdek-Místek
ČESKÁ REPUBLIKA
tel. +420 558 402 511, 603 504 218
fax +420 558 694 250
e-mail: kanlux.cz@kanlux.cz

KANLUX S.R.O.

Zlatovská 2179/28, 911 05 Trenčín
SLOVENSKÁ REPUBLIKA
tel. +421 327 446 385-6
fax +421 327 446 387
e-mail: kanlux.sk@kanlux.sk

KANLUX KFT.

9026 Győr, Bácsai út 153/b
HUNGARY
tel. +36 96 525-467
fax +36 96 319-420
e-mail: info@kanlux.hu

ТОВ КАНЛЮКС

08130, Київська область, Києво-Святошинський район,
с.Петропавлівська Борщагівка, вул. Соборна,
будинок 1-Б, офіс 617 УКРАЇНА
тел. +38 (044) 585 33 19
факс +38 (44) 585 33 18
e-mail: kanlux_ua@kanlux.com

ООО КАНЛЮКС-ЭЛЕКТРОМОНТАЖ

142100, Московская область, г. Подольск,
ул. Комсомольская, д.1,
РОССИЙСКАЯ ФЕДЕРАЦИЯ
тел. +7 495 984 82 60
e-mail: russia@kanlux.com

KANLUX EOOD

Warehouse area Gopet Logistics, 1532 Kazichene, Sofia
BULGARIA
tel. +359 2 421 96 24
fax +359 2 421 96 23
e-mail: kanlux.bg@kanlux.com

KANLUX GMBH

Flugplatz 21, 44319 Dortmund
DEUTSCHLAND
Tel. +49 231 56557255
Fax +49 231 56557256
e-mail: kanlux.gmbh@kanlux.com

KANLUX LIGHTING SRL

Kanlux Lighting S.R.L.Oltenitei 249
Popesti Leordeni, 077160, Ilfov,
ROMANIA
tel. +40 371 474 133
e-mail: comenzi@kanlux.com

KANLUX FRANCE SAS

224bis, rue Marcadet, 75018 Paris
FRANCE
tel +33 (0)6 51 64 28 79
e-mail: kanlux.fr@kanlux.com

KANLUX ITALY DISTRIBUTION

mob. + 39 (0) 340 950 26 05
e-mail: kanlux.it@kanlux.com

więcej niż
more than light. **światło.**

NOTA PRAWNA

Niniejsza publikacja została przygotowana przez Kanlux SA. Poprzez ciągłe udoskonalanie swojej oferty i dostosowanie jej do wymogów rynkowych i prawnych Kanlux SA zastrzega sobie prawo do wprowadzenia zmian w asortymencie.

Prezentowana publikacja nie jest ofertą w rozumieniu Kodeksu Cywilnego. Rzeczywiste produkty mogą odbiegać od poglądowych zdjęć i rysunków zamieszczonych w publikacji. Wszystkie dane zawarte w publikacji obowiązują w dniu oddania jej do druku tj. 18 sierpnia 2020.

Kanlux SA nie ponosi odpowiedzialności za brak dostępności produktów zamieszczonych w niniejszej publikacji. Kanlux SA nie ponosi także odpowiedzialności za jakiegokolwiek bezpośrednie, pośrednie, przypadkowe lub jakiegokolwiek inne szkody (w tym również, ale nie wyłącznie, utracone zyski, utracone przychody lub podobne straty ekonomiczne) powstałe w wyniku korzystania z informacji zawartych w niniejszej publikacji.

Kanlux SA zastrzega sobie prawo do błędów i zmian w druku.

LAW NOTICE

This publication has been prepared by Kanlux SA. Through the continuous improvement of its offer and adaptation of it to market and legal requirements, Kanlux SA reserves the right to make changes in its product mix.

This publication is not an offer within the meaning of the Civil Code. Actual products may differ from illustrative photos and drawings included in the publication. All of the data contained in the publication is in force on the date of printing i.e. 18th of August 2020.

Kanlux SA shall not be liable for the non-availability of products listed in this publication. Kanlux SA also shall not be liable for any direct, indirect, accidental or any other damages (including, but not limited to, lost profits, lost revenues or similar economic losses) arising out of the use of information contained in this publication.

Kanlux SA reserves the right for errors and changes in print.



kanlux.com