

General Catalogue



Quality made in Austria



D946E177



Contactors, Motor-Starter (D677E)

Micro Contactors	11
Mini Contactors	25
Contactor Relays	39
Contactors	45
Starters	91
D.O.L. Starters	111
Overload Relays	119
Modular Contactors	133
Contactors for DC-Switching (D911E)	141
Contactors RAST 5 (D778E)	145



Circuit Breakers (D795E)

Circuit-Breakers M4 for motor protection	165
Auxiliary contacts, Signalling switch, Auxiliary releases	166
Insulated 3-pole busbar system, Terminal block	168
DIN-rail adapters, Busbar adapters	169
Link modules, Contactors for Circuit-Breakers M4	171



Manual Motor-Starters (D509E)

Manual Motor-Starters, Auxiliary Contact Blocks	187
Trip Alarm Aux. Switch, Shunt Release	188
Under-voltage Release, Accessories	189
Busbar Connectors, Enclosures	189



Switches (D371E)

Cam Switches	193
Mini-Cam Switches	198
Load switches	236
Handles and plates	240
Optional Extras	242
Special Switches	249



AC-Main Switches (D656E)

Main Switches for Panel Mounting	277
Main Switches for Base Mounting with Door Clutch	280
Main Switches-Emergency-Stop for Panel Mounting	282
Main Switches-Emergency-Stop for Single Hole Mounting	286
Main Switches-Emergency-Stop for Base Mounting with Door Clutch	287
Main Switches-Emergency-Stop for Distribution Boards	288
Maintenance and Safety Switches, in Plastic Enclosures	290
Switch Disconnectors for Panel Mounting	290
Switch Disconnectors for Distribution Boards	292
Switch Disconnectors in Plastic Enclosures	295
Add-on modules	296
	297



DC Switch Disconnectors for Photovoltaic (D911E)

ON-OFF Switches for Panel Mounting	303
ON-OFF Switches for Single Hole Mounting	306
ON-OFF Switches for Base Mounting with Door Clutch	307
ON-OFF Switches for Distribution Boards	308
Main Switches for Panel Mounting	309
Main Switches for Single Hole Mounting	310
Main Switches for Base Mounting with Door Clutch	311
Main Switches for Distribution Boards	312
Main Switches in Plastic Enclosure	313

Technical data, dimension sketches, illustration and weights given in our list and printed matter, are subject to changed without notice.

	Push Buttons (D580E)	329
	Program B3	330
	Push Buttons	331
	EMERGENCY STOP Button	332
	Key Operated Rotary Switches	332
	Rotary Knobs and Swing Knobs	333
	Illuminated Rotary Knobs and Swing Knobs	333
	Illuminated Push Buttons	334
	Double Push Buttons	334
	Lens Caps	334
	Monoblock-Multi-LED	335
	Push Button-Sets	336
	Illuminated Push Button-Sets	336
	Pilot Lights	336
	Connectors	338
	Actuator inserts	338
	Contact Blocks and Lamp Holders	338
	Lamps, LED Lamps	339
	Accessories	339
	Label Holder, Legend Plates, Actuator Caps	340
	Program B5	342
	Push Buttons	343
	Rotary Knobs and Swing Knobs	344
	Key Operated Rotary Switches	345
	Illuminated Push Button	345
	Lens Caps	345
	Connectors	346
	Contact Blocks and Lamp Holders	346
	Lamps, Accessories	347
	Units for Surface Mounting	349
	Assembled Units IP65	349
	Enclosures BG.	350
	Contact Blocks and Lamp Holders for Enclosures BG..	350
	Push Buttons for Enclosures	351
	Extensions for Push Buttons	351



Representatives and Suppliers

359

Index

Page



General

Approvals	4
Technical Information	5
Mounting Information	9
	10



Micro Contactors

Micro Contactors	11
Micro Contactor Relays	12
Micro Reversing Contactors	14
Technical Information	18
Dimensions	20
	24



Mini Contactors

Mini Contactors	25
Interface Contactors	26
Mini Reversing Contactors	26
Technical Information	32
Dimensions	33
	36



Contactor Relays

Contactor Relays	39
Technical Information	40
Dimensions	40
	44



Contactors

Contactors Overview	45
Contactors, 3-pole	46
Contactors, 4-pole	48
Capacitor Switching Contactors	50
Accessories	51
Technical Information	52
Dimensions	62
	82



Starters

Star-Delta Starters	91
Reversing Contactors	92
Pole Changing Starters	96
Technical Information	98
Dimensions	100
	107



D.O.L. Starters

D.O.L. Starters	111
Enclosures	112
Accessories	113
Technical Information	113
Dimensions	115
	116



Overload Relays

Thermal Overload Relays	119
Accessories	121
Technical Information	123
Dimensions	125
	129



Modular Contactors

Contactors	133
Accessories	134
Technical Information	135
Dimensions	138
	140



Contactors for DC-Switching Contactors RAST 5

	141
	145

Technical data, dimension sketches, illustrations and weights given in our list and printed matter are subject to change without notice.

General

Test Authorities, Registration Mark, Approvals

Low voltage switchgear from Benedict GmbH is built and tested to national and international specifications. All devices suit all important specifications without any test obligation, like VDE, BS and also relative to IEC Recommendations and to European Standards like IEC 947 and EN 60947. It is for this reason of our Low voltage switchgear is used all over the world. In order to provide special versions, limitations to the max. voltages, currents and power ratings or special markings are sometimes necessary.

Quality Control System

Since November 1991 Benedict GmbH has been certified according to the quality control system **ÖNORM EN ISO 29001**. The target of the ISO-certification is, to grant the customer the quality of the performance of his supplier, who is audited in accordance with this standard.

CE-Marking



The manufacturer has to sign his products with the CE-Marking. With the CE-Marking the manufacturer confirms the accordance with the different EEC Directives. The CE-Marking is absolutely necessary to sell the products in the EEC.

Below you find the EEC Directives concerning our products.

Low Voltage Directive 2006/95/EC

EMC Directive 2004/108/EC

RoHS + WEEE 2002/95/EC + "002/96/EC

Country	North America	Russia	China
State deputy or private examination (state admitted)	UL Canada, USA	EAC	CCC
Label marking of examination boards	Listed Component		
Duty of approvals	all switchgear	all switchgear	all switchgear

Explanations for choice and supply of low voltage switchgear in Canada and USA

Marking of auxiliary contacts

At several devices in UL-data are two voltages for auxiliary contacts mentioned (e. g.: 600 volts at same potential, 150 volts at different potentials). That means, if the voltage is higher than 150 volts, the control voltage applied to input terminals must be at the same potential.

Low voltage switchgear for auxiliary circuits (e. g. contactor relays, control units, auxiliary contacts in general) usually approved for "Heavy Duty" or "Standard Duty" UL and besides these marked with the admissible max. voltage or with short codes (see table).

Marking of auxiliary contacts according to CSA and UL	Max. rated values per pole			Cont. Current A	Contact Rating Code Designation
	Voltage V	Current Make A	Break A		
Heavy Duty (HD or HVY DTY)	AC 120	60	6	10	A150
	AC 240	30	3	10	A300
	AC 480	15	1,5	10	A600
	AC 600	12	1,2	10	A600
	DC 125	2,2	2,2	10	N150
	DC 250	1,1	1,1	10	N300
	DC 600	0,4	0,4	10	N600
Standard Duty (SD or STD DTY)	AC 120	30	3	5	B150
	AC 240	15	1,5	5	B300
	AC 480	7,5	0,75	5	B600
	AC 600	6	0,6	5	B600
	DC 125	1,1	1,1	5	P150
	DC 250	0,55	0,55	5	P300
	DC 600	0,2	0,2	5	P600
-	AC 120	15	1,5	2,5	C150
	AC 240	7,5	0,75	2,5	C300
	AC 480	3,75	0,375	2,5	C600
	AC 600	3	0,3	2,5	C600
	DC 125	0,55	0,55	2,5	Q150
	DC 250	0,27	0,27	2,5	Q300
	DC 600	0,1	0,1	2,5	Q600
-	AC 120	3,6	0,6	1	D150
	AC 240	1,8	0,3	1	D300
	DC 125	0,22	0,22	1	R150
	DC 250	0,11	0,11	1	R300
-	AC 120	1,8	0,3	0,5	E150

Discernment at UL-Standards

Recognized Component Industrial Control Equipment

UL issues yellow "Guide cards" with Guide- and File-No.

Devices have permission to be marked with on the label



Devices as components approved for "factory wiring": devices for employment in control panels, when they are selected, mounted and wired according to the charging conditions by skilled worker.

Valid UL-Standards: UL 508 "Standard for Industrial Control Equipment" (partly limited)

Listed Industrial Control Equipment

UL issues white "Guide cards" with Guide- and File-No.

Devices have to be marked with the "UL-Listing Mark"



Devices approved for "field wiring",
a) devices for employment in control panels, when they are mounted and wired by skilled worker.
b) devices for retail in USA

Valid UL-Standards: UL 508 "Standard for Industrial Control Equipment" (unlimited)

Are devices approved as "Listed Equipment" the approval is also valid for using as "Recognized Component" .

Approvals

Country	North America	Switzerland	Europe	Russia	China	CENELEC
	UL	SEV		EAC		CB-Certificates
Type						
Micro Contactor Relays, Micro Contactors K0, Micro Reversing Contactors and Accessories						
K0-04D..	-	-	o	-	-	-
K0-05D..	o	-	o	-	o	-
K0W05D..	o	-	o	-	o	-
Mini Contactor Relays, Mini Contactors, Mini Reversing Contactors K1 and Accessories						
K1-07D..(=)	o	-	o	o	-	o
K1-07L..(=)	-	o	o	o	-	o
K1-07F..(=)	-	o	o	o	-	-
K1-09D..(=)	o	-	o	o	o	o
K1-09L..(=)	-	o	o	o	o	o
K1-09F..(=)	-	o	o	o	o	-
K1-12D..(=)	o	-	o	o	o	-
K1W09D01(=)	o	-	o	o	o	-
K1W12D01(=)	o	-	o	o	o	-
K1W09L01(=)	-	o	o	o	o	-
HK..., HKM..	o	-	o	o	-	o
RC-K1	o	-	o	o	-	-
Contactor Relays, Contactors Series K3						
K3-07ND..(=)	o	-	o	o	-	-
K3-10N..(=)	o	-	o	o	o	o
K3-14N..(=)	o	-	o	o	o	o
K3-18N..(=)	o	-	o	o	o	o
K3-22N..(=)	o	-	o	o	o	o
K3-24A..(=)	o	-	o	o	o	o
K3-32A..(=)	o	-	o	o	o	o
K3-40A..(=)	o	-	o	o	o	o
K3-50A..(=)	o	-	o	o	o	o
K3-62A..(=)	o	-	o	o	o	o
K3-74A..(=)	o	-	o	o	o	o
K3-90A..(=)	o	-	o	o	o	-
K3-115A..(=)	o	-	o	o	o	-
K3-151A..(=)	o	-	o	o	-	-
K3-176A..(=)	o	-	o	o	-	-
K3-210A..(=)	x	-	o	o	-	-
K3-260A..(=)	x	-	o	o	-	-
K3-316A..(=)	x	-	o	o	-	-
K3-450A..(=)	o	-	o	o	-	-
K3-550A..(=)	o	-	o	o	-	-
K3-700A..(=)	o	-	o	o	-	-
K3-860A..(=)	o	-	o	o	-	-
K3-1000A..(=)	-	-	o	o	-	-
K3-1200A..(=)	o	-	o	o	-	-
Contactor Relays, Contactors DC operated Series KG3						
KG3-07..	o	-	o	o	-	o
KG3-10..., -14..	o	-	o	o	-	o
KG3-18..., -22..	o	-	o	o	-	o
KG3-24..., -32..	o	-	o	o	-	o
KG3-40..	o	-	o	o	-	o
Capacitor Contactors Series K3						
K3-18K..	o	-	o	o	o	o
K3-24K..	o	-	o	o	o	o
K3-32K..	o	-	o	o	o	o
K3-50K..	o	-	o	o	o	o
K3-62K..	o	-	o	o	o	o
K3-74K..	o	-	o	o	o	o
K3-90K..	o	-	o	o	o	-
K3-115K..	o	-	o	o	o	-
Aux. Contacts						
HN..., HTN..	o	-	o	o	o	o
HA..	o	-	o	o	-	o
HB..	o	-	o	o	o	o
K2-DK, K2-SK	o	-	o	o	-	-
HKA..., HKT..	o	-	o	o	-	-
HKF22	-	-	o	o	-	-

o approved in standard version x pending - not provided to be tested

Approvals

Country	North America		Switzerland	Europe	Russia EAC	China	CENELEC CB-Certificates
	UL		SEV				
Typ							
Accessories							
K2-T, E, -A	-	-	-	0	0	-	-
K2-TP	0	-	-	0	0	-	-
K2-L	0	-	-	0	0	-	-
K2-IN.	0	-	-	0	0	-	-
K2-UN.	0	-	-	0	0	-	-
K2-IM	-	-	-	0	0	-	-
K2-E	0	-	-	0	0	-	-
VG-K2	-	-	-	0	0	-	-
RC-K3	0	-	-	0	0	-	-
Reversing Contactors Series K3NWU							
K3NWU-10	0	-	-	0	0	-	-
K3NWU-14	0	-	-	0	0	-	-
K3NWU-18	0	-	-	0	0	-	-
K3NWU-22	0	-	-	0	0	-	-
K3WU-24	0	-	-	0	0	-	-
K3WU-32	0	-	-	0	0	-	-
K3WU-40	0	-	-	0	0	-	-
D.O.L Starters							
P1..	0	-	-	0	0	-	-
Thermal Overload Relays							
U3/32	0	-	-	0	0	-	0
U3/42	0	-	-	0	0	-	0
U3/74	0	-	-	0	0	-	0
U12/16E	0	-	-	0	0	-	0
U12/16A	-	-	-	0	0	-	0
U12/16EM	-	-	-	0	0	-	0
U12/16EQ	-	-	-	0	0	-	0
U32	0	-	-	0	0	-	0
U60	0	-	-	0	0	-	0
U85	0	-	-	0	0	-	0
U180	x	-	-	0	0	-	-
U320	x	-	-	0	0	-	-
U800	-	-	-	0	0	-	-
Modular Contactors							
R20	0	-	0	0	0	-	0
R25	0	-	0	0	0	-	0
R40	0	-	0	0	0	-	0
R63	0	-	0	0	0	-	0
R40, R63 2-polig	-	-	-	0	0	-	0
RH11	0	-	-	0	0	-	0
Push Buttons							
B(C,K,S)3/4/5D	0	-	-	0	0	-	0
Contactor Relays and Contactors Series K3 (RAST 5)							
K3-10/14/18/22NR	0	-	-	0	0	0	0
Contactors for DC-Loads							
K3DC-20 bis 80	0	-	-	0	0	-	0
K3DC-100	-	-	-	0	0	-	0
K3PV-30 bis 60	-	-	-	0	0	-	0
K3PV-80	0	-	-	0	0	-	0
K3PV-100	-	-	-	0	0	-	0
K3PV-150 bis 450	0	-	-	0	0	-	0
Main Contactors Series K3							
K3-10/14/18/22NBD	-	-	-	0	0	-	0

o approved in standard version

x pending

- not provided to be tested

Approvals

Country	North America	Switzerland	Europe	Russia EAC	China	CENELEC CB-Certificates
---------	---------------	-------------	--------	---------------	-------	----------------------------

Typ

Motor Protection Circuit Breakers Series M4-..

M4-32T	o	-	-	o	-	-
M4-32R	o	-	-	o	-	-
M4-63R	o	-	-	o	-	-
M4-100R	o	-	-	o	-	-

Zubehör

M4 HQ	o	-	-	o	-	-
M4 HS	o	-	-	o	-	-
M4 MA	o	-	-	o	-	-
M4 M	o	-	-	o	-	-
M4 U	o	-	-	o	-	-
M4 A	o	-	-	o	-	-

Motor Protection Circuit Breakers Series MU25A-..

MU25A	o	-	-	o	-	-
-------	---	---	---	---	---	---

Accessories

MU25A-PS	o	-	-	o	-	-
MU25A-PV	o	-	-	o	-	-
MU25A-A	o	-	-	o	-	-
MU25A-U	o	-	-	o	-	-

Mini DC-Isolators

LSM16/25	o	o	-	-	o	-
----------	---	---	---	---	---	---

DC-Switch Disconnectors, 2, 2+2, 4 pole

LS16/20/25/32	o	-	-	o	o	o
LS40/55	o	-	-	o	o	o

DC-Switch Disconnectors, 3+2, 4+2, 6, 8 pole

LS16/20/25/32	o	o	-	o	o	-
LS40/55	o	o	-	o	o	-

AC-Main Switches

LTS20/25/32/40	o	-	-	o	-	o
LTS63/80	o	-	-	o	-	o
LTS85/100/125	o	-	-	o	-	o

AC-Cam Switches

M4H	o	-	-	o	-	o
M10	o	-	-	o	-	o
M10H(D)	o	-	-	o	-	o
M20	o	-	-	o	-	o
N33F	o	-	-	o	-	o
N40	o	-	-	o	-	o
N60	o	-	-	o	-	o
N61	o	-	-	o	-	o
N80	o	-	-	o	-	o
N100	o	-	-	o	-	o
N200	o	-	-	o	-	o
L400	o	-	-	o	-	o

o approved in standard version

x pending

- not provided to be tested

These data are important for UL-inspectors.

Devices

Guide-No.

File-No.

	Guide-No.		File-No.		
	Canada	USA	Canada	USA	
Contactors	NLDX7	NLDX	NLDX8	NLDX2	E41502
Revering Contactors	NLDX7	NLDX	-	-	E41502
Contactors Relays, Accessories	NKCR7	NKCR	NKCR8	NKCR2	E66273
Thermal Overload Relays	NKCR7	NKCR	-	-	E66273
Cam Switches	NLRV7	NLRV	-	-	E129916
Circuit Breakers as Manual Motor Controller	NLRV7	NLRV	-	-	E129916
Circuit Breakers as Combination Motor Controller	NKJH7	NKJH	-	-	E197641
Bus Bar Assemblies	NLRV7	NLRV	-	-	E129916
Accessories for Circuit Breakers	NKCR7	NKCR	-	-	E66273

Technical Information

Degree of protection acc. to IEC 60947-1

Protection ratings are prefixed by the internationally agreed letters IP followed by two digits.

1st digit: Pertains to solid objects
2nd digit: Pertains to water.

1 st digit	Short description	Definition
1	Protected against solid objects greater than 50 mm	Excludes solid objects exceeding 50 mm in diameter and protects against contact with live and moving parts by a large body surface such as a hand (but not against deliberate access).
2L	Protected against solid objects greater than 12,5 mm and against contact by standard test finger	Excludes solid objects exceeding 12,5 mm in diameter and protects against contact with live and moving parts by a standard test finger or similar objects not exceeding 80 mm in length.
3	Protected against solid objects	Excludes solid objects exceeding 2,5 mm in diameter or thickness, greater than 2,5mm
4	Protected against solid objects greater than 1 mm	Excludes solid objects exceeding 1 mm in diameter or thickness.
5	Dust protected	Prevents ingress of dust in quantities and locations that would interfere with the intended operation of the equipment.
6	Dust tight	Prevents ingress of dust.

Terminal markings acc. to EN50011

Auxiliary contacts of AC contactors and contacts of contactor relays and thermal overload relays are particularly marked. The terminal markings of normally-open contacts are printed as positive figures, they of normally-closed contacts as negative figures.

This gives a clear indication of the function of the contacts.

The figure below illustrates the determination of terminal markings for contactors with auxiliary contact blocks.

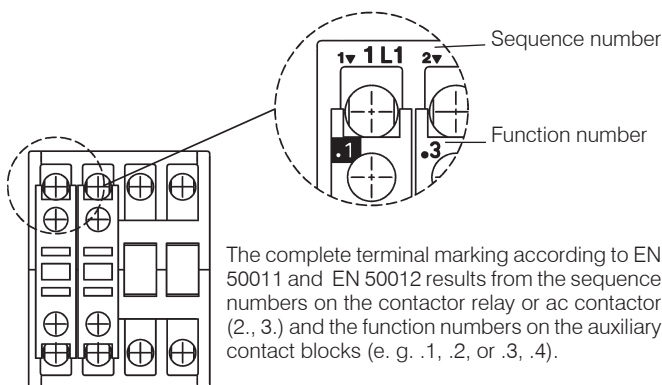

2 nd digit	Short description	Definition
1	Protected against dripping water	Dripping water (vertically falling drops) shall have no harmful effect.
2	Protected against dripping water when tilted up to 15°	Vertically dripping water shall have no harmful effect when the enclosure is tilted at any angle up to 15° from its normal position.
3	Protected against spraying water	Water falling as a spray at an angle up to 60° from the vertical shall have no harmful effect.
4	Protected against splashing water	Water splashed against the enclosure from any direction shall have no harmful effect.
5	Protected against water jets	Water protected by a nozzle against the enclosure from any direction shall have no harmful effect.
6	Protected against heavy seas	Water from heavy seas or water projected in powerful jets shall not enter the enclosure in harmful quantities.
7	Protected against the effects of immersion	Ingress of water in a harmful quantity shall not be possible when the enclosure is immersed in water under standard conditions of pressure and time.
8	Protected against submersion	No ingress of water.

Resistance to climatic conditions acc. to IEC60068

Open-type devices are climate-resistant in the constant climate according to IEC60068-2-78 (this is a climate with an ambient temperature of 40°C and an atmospheric humidity of 90 to 95%).

Enclosed devices are climate-resistant in an alternating climate according to IEC 68-2-30 (this is a moist alternating climate with a 24-hour cycle between climates with an ambient temperature of 25°C, and an atmospheric humidity of 95 to 100% and an ambient temperature of 40°C, and an atmospheric humidity of 90 to 96% in the presence of condensation during rises in temperature).

Data are valid up to an altitude of 2000m above sea level.

Short circuit protection

Back up fuses should be used to protect contactors and starters against short circuits. For starters the device with the smaller admissible fuse at the main and at the control circuit (contactor or thermal overload) determines the fuse size.

After a short circuit devices have to be checked for correct operation. Disconnect power before proceeding with any work on the equipment!

Technical Information

Mounting positions of contactors

K0-.. / K1-..

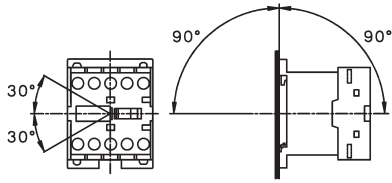

K2-..A00-40, K(G)3-07 bis K3-115, R..

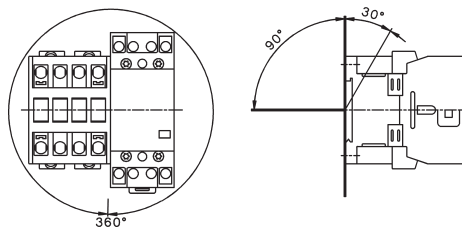



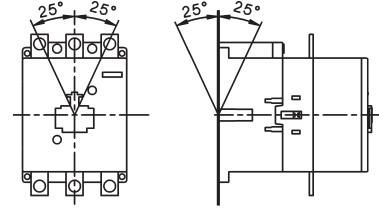



K3-151.. bis K3-1200..



Terminal screws

Devices Type	Kind of connection			Screw driver	Tightening torque	
	Screw with washer	Screw with clamp box	Screw w. nut		Nm	lb. inch
Micro Contactors , all conductors K0-..	M2,5	-	-	Pz1	0,6 - 0,8	5 - 7
Mini Contactors , all conductors K1-..	M3,5	-	-	Pz2	0,8 - 1,4	7 - 12
Contactor Relays , all conductors K(G)3-07..	M3,5	-	-	Pz2	0,8 - 1,4	7 - 12
Contactors Main conductor						
K(G)3-10.. bis K3-22..	M3,5	-	-	Pz2	0,8 - 1,4	7 - 12
K(G)3-24.. bis K3-40..	-	M5	-	Pz2	2,5 - 3	22 - 26
K3-50.. bis K3-74..	-	M6	-	Pz3	3,5 - 4,5	31 - 40
K2-23, -30, -37A00-40 K2-45, -60A00-40	M4 -	- M6	- -	Pz2 Pz3	1,2 - 1,8 3,5 - 4,5	11 - 16 31 - 40
K3-90, K3-115	-	-	M8	4mm hex socket	4 - 6,5	35 - 57
K3-116.. bis K3-176.. K3-210.. bis K3-316.. K3-450.. bis K3-700.. K3-860.. K3-1000., K3-1200..	- - - - -	- - - - -	M8 M10 M12 M14 M12		17 35 60 75 60	150 315 540 675 540
Auxiliary conductor K(G)3-10 bis K3-22	M3,5	-	-	Pz2	0,8 - 1,4	7 - 12
Coil conductor K(G)3-10 bis K3-1200	M3,5	-	-	Pz2	0,8 - 1,4	7 - 12
Accessories						
HK, HKM	M3,5	-	-	Pz2	0,8 - 1,4	7 - 12
HA, HN, K2-..., HB..	M3,5	-	-	Pz2	0,8 - 1,4	7 - 12
Thermal Overload Relays Main conductor						
U12/16	M4	-	-	Pz2	1,2 - 1,8	11 - 16
U3/32	M3,5	-	-	Pz2	0,8 - 1,4	7 - 12
U3/42	M5	-	-	Pz2	2,5 - 3	22 - 26
U3/74	-	M6	-	Pz3	3,5 - 4,5	31 - 40
UAT21	-	M4	-	Size 3, 4	1,2 - 1,8	11 - 16
UAT22	-	M4	-	Size 3, 4	1,2 - 1,8	11 - 16
UAT23	-	M5	-	Size 3, 4, 5	2,5 - 3	22 - 26
Auxiliary conductor All devices	M3,5	-	-	Pz2	0,8 - 1,4	7 - 12
Contactors for Distribution Boards Conductors						
R20, R25	-	M3,5	-	Pz1	0,8 - 1,4	7 - 12
R40, R63	-	M5	-	Pz2	2,5 - 3	22 - 26
K1R	M3,5	-	-	Pz2	0,8 - 1,4	7 - 12
Coil conductor						
R20, R25	-	M3	-	Pz1	0,6 - 1,2	5 - 11
R40, R63	-	M3	-	Pz2	0,6 - 1,2	5 - 11
K1R	M3,5	-	-	Pz2	0,8 - 1,4	7 - 12
RH11	-	M3	-	Pz1	0,6 - 1,2	5 - 11

	<p>Micro Contactor Relays</p>	<p>12</p>
	<p>Micro Contactors</p>	<p>14</p>
	<p>Micro Contactors With Solder Pins</p> <p>Coil voltages</p>	<p>16</p> <p>16</p>
	<p>Micro Reversing Contactor</p>	<p>18</p>
	<p>Technical Data</p>	<p>20</p>
	<p>Dimensions</p>	<p>24</p>

Micro Contactor Relays 4-pole

AC Operated

Ratings Therm.	Contacts ²⁾		Type	Coil voltage ¹⁾
	Distinc. Number	Additional Contact		

AC15	Rated Current	Blocks Type	acc. to EN50011	Blocks Type	↓	Pack pcs.	Weight kg/pc.
230V A	400V A I_{th}	NO NC					

4-pole, with Screw Terminals



3	1,5	5	4	-	40E	-	K0-04D40 ...	10	0,07
3	1,5	5	3	1	31E	-	K0-04D31 ...	10	0,07
3	1,5	5	2	2	22E	-	K0-04D22 ...	10	0,07

K0-04D40

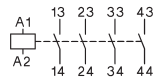

K0-04D31

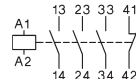

K0-04D22

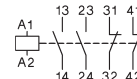

1) Other coil voltages on request.
 2) Contacts suitable for electronic circuits, according to EN947-5-4 for rated voltage 24V DC (test ratings 17V DC, 5mA). Mirror contacts acc. IEC60947-4-1 Annex F.

Micro Contactor Relays 4-pole

DC Operated

Ratings Therm.	Contacts ²⁾	Distinc. Number	Additional Contact	Type	Coil voltage ¹⁾	Pack pcs.	Weight kg/pc.
AC15	Rated Current				= 24		
230V A	400V A	I_{th} A	NO NC	acc. to EN50011	24V=DC		
				Blocks Type			



4-pole, with Screw Terminals

3	1,5	5	4	-	40E	-	K0-04D40= ...	10	0,09
3	1,5	5	3	1	31E	-	K0-04D31= ...	10	0,09
3	1,5	5	2	2	22E	-	K0-04D22= ...	10	0,09

K0-04D40

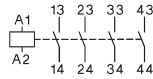

K0-04D31

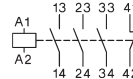

K0-04D22

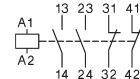

1) Other coil voltages on request.

2) Contacts suitable for electronic circuits, according to EN947-5-4 for rated voltage 24V DC (test ratings 17V DC, 5mA). Mirror contacts acc. IEC60947-4-1 Annex F.

Micro Contactors

AC Operated

Power Ratings	Rated Current	Aux. Contacts ²⁾		Type	Coil voltage ¹⁾	Pack pcs.	Weight kg/pc.
		Built-in	Additional				
AC2, AC3	AC1			24	24V 50/60Hz		
380V				230	220-240V 50Hz/60Hz		
400V	660V						
415V	690V	440V					
kW	kW	A	NO NC	Blocks Type			



3-pole, with Screw Terminals

2,2	-	12	1	-	-	K0-05D10 ...	10	0,07
-----	---	----	---	---	---	---------------------	----	------

2,2	-	12	-	1	-	K0-05D01 ...	10	0,07
-----	---	----	---	---	---	---------------------	----	------

4-pole, With Screw Terminals

2,2	-	12	-	-	-	K0-05D00-40 ...	10	0,07
-----	---	----	---	---	---	------------------------	----	------

K0-05D10

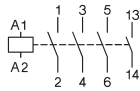

K0-05D01

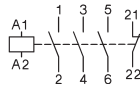

K0-05D00-40

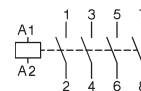

1) Other coil voltages see page 14.

2) Contacts suitable for electronic circuits, according to EN947-5-4 for rated voltage 24V DC (test ratings 17V DC, 5mA). Mirror contacts acc. IEC60947-4-1 Annex F.

Micro Contactors

DC Operated

Power Ratings	Rated Current	Aux. Contacts ²⁾		Type	Coil voltage ¹⁾ = 24 24V= DC	Pack pcs.	Weight kg/pc.
		Built-in	Additional				
AC2, AC3	AC1						
380V							
400V	660V						
415V	690V	440V					
kW	kW	A	NO NC	Blocks Type			



3-pole, with Screw Terminals

2,2	-	12	1	-	-	K0-05D10= ...	10	0,09
-----	---	----	---	---	---	----------------------	----	------

2,2	-	12	-	1	-	K0-05D01= ...	10	0,09
-----	---	----	---	---	---	----------------------	----	------

4-pole, With Screw Terminals

2,2	-	12	-	-	-	K0-05D00-40= ...	10	0,09
-----	---	----	---	---	---	-------------------------	----	------

K0-05D10

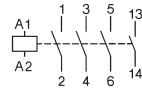

K0-05D01

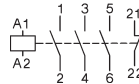

K0-05D00-40

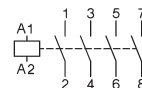

Snap-On Adapter

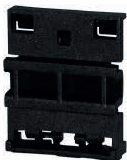

For Type	Specification	Type	Pack pcs..	Weight kg/pc.
K0	Snap on Adapter for K0	P1039	10	0,0061
	for snap-on mounting of contactor K0 on 35mm DIN-rail acc. DIN EN 50022			

1) Other coil voltages see page 14.
 2) Contacts suitable for electronic circuits, according to EN947-5-4 for rated voltage 24V DC (test ratings 17V DC, 5mA). Mirror contacts acc. IEC60947-4-1 Annex F.

Micro Contactors

AC Operated

Power Ratings	Rated Current	Aux. Contacts ²⁾		Type	Coil voltage ¹⁾	Pack pcs.	Weight kg/pc.
		Built in	Additional				
AC2, AC3	AC1			24	24V 50/60Hz		
380V				230	220-240V 50Hz/60Hz		
400V	660V						
415V	690V	440V					
kW	kW	A					



3-pole, with Solder Pins Ø1,15 for Printed Circuit Applications

2,2	-	9	1	-	-	K0-05L10 ...	10	0,07
-----	---	---	---	---	---	---------------------	----	------

2,2	-	9	-	1	-	K0-05L01 ...	10	0,07
-----	---	---	---	---	---	---------------------	----	------

4-pole, with Solder Pins Ø1,15 for Printed Circuit Applications

2,2	-	9	-	-	-	K0-05L00-40 ...	10	0,07
-----	---	---	---	---	---	------------------------	----	------

K0-05L10

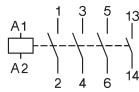

K0-05L01

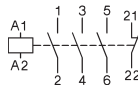

K0-05L00-40

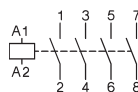

Coil voltages for AC operated contactors

Suffix to contactor type e.g. K0-05D10 24	Voltage Marking at the coil for		Rated Control Voltage U _s range for 50Hz				for 60Hz	
	50Hz	for 60Hz	min.	max.	min.	max.	min.	max.
12	12	12	11	12	12	12		
24	24	24	22	24	24	24		
42	42	42	38,5	42	42	42		
48	48	48	48	50	48	52		
90	100	100	90	100	100	105		
95	95-100	105-110	95	100	105	110		
100	100	110-115	100	105	110	115		
105	105-110	115-120	105	110	115	120		
110	110-115	120-125	110	115	120	125		
180	200	200	185	200	200	210		

Suffix to contactor type e.g. K0-05D10 230	Voltage Marking at the coil for		Rated Control Voltage U _s range for 50Hz				for 60Hz	
	50Hz	for 60Hz	min.	max.	min.	max.	min.	max.
200	200	200-220	195	205	200	220		
210	205-215	220-230	205	215	220	230		
220	210-220	220-240	210	220	220	240		
230	220-230	230-250	220	230	230	250		
240	230-240		230	240	250	260		

Standard voltages in bold type letters
Operating range of magnet-coils: 0,85 x U_s
(min. value of rated control voltage)
up to 1,1 x U_s
(max. value of rated control voltage)

Coil not exchangeable

1) Other coil voltages see page 14.

2) Contacts suitable for electronic circuits, according to EN947-5-4 for rated voltage 24V DC (test ratings 17V DC, 5mA). Mirror contacts acc. IEC60947-4-1 Annex F.

Power Ratings	Rated Current	Aux. Contacts ²⁾		Type	Coil voltage ¹⁾ = 24 24V= DC	Pack pcs.	Weight kg/pc.
		Built in	Additional				
AC2, AC3 380V 400V 415V kW	660V 690V kW	AC1	440V A	NO NC Type	↓		



3-pole, with Solder Pins Ø1,15 for Printed Circuit Applications

2,2	-	9	1	-	-	K0-05L10 ...	10	0,07
-----	---	---	---	---	---	---------------------	----	------

2,2	-	9	-	1	-	K0-05L01 ...	10	0,07
-----	---	---	---	---	---	---------------------	----	------

4-pole, with Solder Pins Ø1,15 for Printed Circuit Applications

2,2	-	9	-	-	-	K0-05L00-40 ...	10	0,07
-----	---	---	---	---	---	------------------------	----	------

K0-05L10

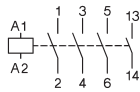

K0-05L01

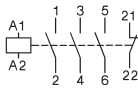

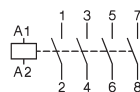

K0-05L00-40



1) Other coil voltages see page 14.
 2) Contacts suitable for electronic circuits, according to EN947-5-4 for rated voltage 24V DC (test ratings 17V DC, 5mA). Mirror contacts acc. IEC60947-4-1 Annex F.

Micro Reversing Contactors, Mechanical Interlocked

AC Operated

Power Ratings	Rated Current	Aux. Contacts ²⁾ Built-in	Additional		Type	Coil voltage ¹⁾ 24V 50/60Hz 230 220-240V 50Hz/60Hz	Pack pcs.	Weight kg/pc.
			on left hand side Contactor	on right hand side Contactor				
AC2, AC3 380V 400V 415V kW	AC1 660V 690V kW	440V A	 	K1 Type	K2 Type	▼		

3-pole, with Screw Terminals



2,2	-	12	-	1	-	-	K0W05D01MC ...	1	0,14
-----	---	----	---	---	---	---	-----------------------	---	------

2,2	-	12	1	-	-	-	K0W05D10MC ...	1	0,14
-----	---	----	---	---	---	---	-----------------------	---	------

4-pole, with Screw Terminals

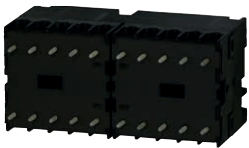

2,2	-	12	-	-	-	-	K0W05D00-40MC ...	1	0,14
-----	---	----	---	---	---	---	--------------------------	---	------

3-pole, with Solder Pins Ø1,15 for Printed Circuit Applications

2,2	-	xxx ³⁾	-	1	-	-	K0W05L01MC ...	1	0,14
-----	---	-------------------	---	---	---	---	-----------------------	---	------

2,2	-	xxx ³⁾	1	-	-	-	K0W05L10MC ...	1	0,14
-----	---	-------------------	---	---	---	---	-----------------------	---	------

K0W05D01MC

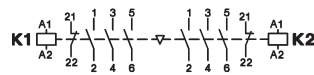

K0W05D10MC

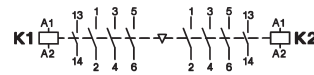

K0W05D00-40MC

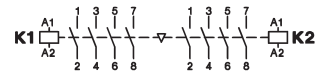

1) Other coil voltages see page 14.
 2) Contacts suitable for electronic circuits, according to EN947-5-4 for rated voltage 24V DC (test ratings 17V DC, 5mA). Mirror contacts acc. IEC60947-4-1 Annex F.
 3) Data on request.

Micro Reversing Contactors, Mechanical Interlocked

DC Operated

Power Ratings	Rated Current	Aux. Contacts ²⁾		Type	Coil voltage ¹⁾ = 24 24V= DC	Pack pcs.	Weight kg/pc.
		Built-in	Additional				
AC2, AC3 380V 400V 415V kW	AC1 660V 690V A		on left hand side Contactor on right hand side Contactor	K1 Type K2 Type	▼		

3-pole, with Screw Terminals

2,2	-	12	-	1	-	-	K0W05D01MC ...	1	0,14
2,2	-	12	1	-	-	-	K0W05D10MC ...	1	0,14

4-pole, with Screw Terminals

2,2	-	12	-	-	-	-	K0W05D00-40MC ...	1	0,14
-----	---	----	---	---	---	---	--------------------------	---	------

3-pole, with Solder Pins Ø1,15 for Printed Circuit Applications

2,2	-	xxx ³⁾	-	1	-	-	K0W05L01MC ...	1	0,14
2,2	-	xxx ³⁾	1	-	-	-	K0W05L10MC ...	1	0,14

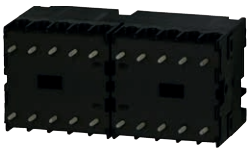

K0W05D01MC

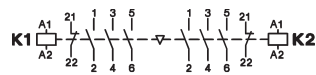

K0W05D10MC

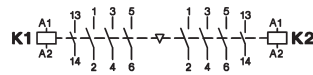

K0W05D00-40MC

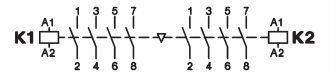

1) Other coil voltages see page 14.
 2) Contacts suitable for electronic circuits, according to EN947-5-4 for rated voltage 24V DC (test ratings 17V DC, 5mA). Mirror contacts acc. IEC60947-4-1 Annex F.
 3) Data on request.

Micro Contactors

Data according to IEC 60947-4-1, VDE 0660, EN 60947-4-1

Main Contacts	Type	K0-05D..	K0-05L..
Rated insulation voltage U_i	V AC	440 ¹⁾	440 ¹⁾
Making capacity I_{eff} at $U_e = 440V$ AC	A	65	65
Breaking capacity I_{eff} $\cos\phi = 0,65$ 400V AC	A	50	50
Utilization category AC1			
Switching of resistive load			
Rated operational current $I_e (=I_{th})$ at 40°C, open	A	12	9
Rated operational power of three-phase resistive loads 50-60Hz, $\cos\phi = 1$	230V kW	4,7	3,5
	240V kW	4,8	3,7
	400V kW	8,3	3,3
	415V kW	8,6	6,4
	440V kW	9,0	6,8
Rated operational current $I_e (=I_{th})$ at 60°C, enclosed	A	8	6
Rated operational power of three-phase resistive loads 50-60Hz, $\cos\phi = 1$	230V kW	3,1	2,3
	240V kW	3,3	2,4
	400V kW	5,5	4,1
	415V kW	5,7	4,3
	440V kW	6,0	4,5
Minimum cross-section of conductor at load with $I_e (=I_{th})$	mm ²	1,5	-
Utilization category AC2 and AC3			
Switching of three-phase motors			
Rated operational current I_e open and enclosed	220V A	6,2	6,2
	230V A	6,2	6,2
	240V A	5,6	5,6
380-400V	A	5	5
	415-440V A	5	5
Rated operational power of three-phase motors 50-60Hz	220-240V kW	1,5	1,5
	380-440V kW	2,2	2,2
Utilization category AC4			
Switching of squirrel cage motors, inching			
Rated operational current I_e open and enclosed	220V A	4,9	4,9
	230V A	4,9	4,9
	240V A	4,1	4,1
380-400V	A	3,5	3,5
	415-440V A	3,5	3,5
Rated operational power of three-phase motors 50-60Hz	220-240V kW	1,1	1,1
	380-440V kW	1,5	1,5
Utilization category AC5a			
Switching of gas discharge lamps			
Rated operational current I_e per pole at 220/230V			
Fluorescent lamps, uncompensated and serial compensated parallel compensated dual-connection	A	6	6
	A	0,5	0,5
	A	9	9
Metal halide lamps ²⁾ , uncompensated parallel compensated	A	6	6
	A	0,5	0,5
Mercury-vapour lamps ³⁾ , uncompensated parallel compensated	A	9	9
	A	0,5	0,5
Mixed light lamps ⁴⁾	A	9	9
LED-Lamps			
consider the inrush current of the lamp ballast and $\cos\phi$ of the lamp	max. lamps per pole ($I_{inLED} \leq I_{th}$) =	inrush current of contactor inrush current of lamp/EVG	
max inrush current of contactor	A	91	91
Utilization category AC5b			
Switching of incandescent lamps⁵⁾			
Rated operational current I_e per pole at 220/230V	A	3	3

1) Suitable for: earthed-neutral systems, overvoltage category I to III, pollution degree 3 (standard-industry): $U_{imp} = 4kV$.
Data for other conditions on request.

2) Metal halide lamps and sodium-vapour lamps (high- and low-pressure lamps)

3) High-pressure lamps

4) Blended lamps, containing a mercury high-pressure unit and a tungsten helix in a fluorescent glass bulb (daylight lamps)

5) Current inrush approx. 16 x I_e

Micro Contactors

Data according to IEC 60947-4-1, VDE 0660, EN 60947-4-1

Main Contacts	Type	K0-05D..	K0-05L..
Utilization category DC1			
Switching of resistive load	1 pole 24V A	12	9
Time constant L/R ≤1ms	60V A	12	9
Rated operational current I _e	110V A	-	-
	220V A	-	-
	3 poles in series 24V A	12	9
	60V A	12	9
	110V A	12	9
	220V A	-	-
Utilization category DC3 and DC5			
Switching of shunt motors and series motors	1 pole 24V A	12	9
	60V A	-	-
Time constant L/R ≤15ms	110V A	-	-
Rated operational current I _e	220V A	-	-
	3 Pole in Serie 24V A	12	9
	60V A	12	9
	110V A	12	9
	220V A	-	-
Maximum ambient temperature			
Operation	open °C	-40 to +60 (+90) ¹⁾	
	enclosed °C	-40 to +40	
with thermal overload relay	open °C	-25 to +60	
	enclosed °C	-25 to +40	
Storage	°C	-50 to +90	
Short circuit protection			
for contactors without thermal overload relay			
Coordination-type "1" according to IEC 947-4-1			
Contact welding without hazard of persons max. fuse size	gL (gG) A	32	32
Coordination-type "2" according to IEC 947-4-1			
Light contact welding accepted max. fuse size	gL (gG) A	-	-
Contact welding not accepted max. fuse size	gL (gG) A	-	-
For contactors with thermal overload relay the device with the smaller admissible backup fuse (contactor or thermal overload relay) determines the fuse size.			
Cable cross-sections			
for contactors			
main connector	solid or stranded mm ²	0,5 - 1,5	Solder Connector
	flexible mm ²	0,5 - 1,5	Ø 1,15
Cables per clamp	flexible with multicore cable end mm ²	0,5 - 1,5	-
	solid or stranded AWG	2	-
		20 - 14	
Frequency of operation z			
contactors without thermal oberload relay	without load 1/h	10000	10000
	AC3, I _e 1/h	600	600
	AC4, I _e 1/h	120	120
	DC3, I _e 1/h	600	600
Mechanical life			
	AC operated S x10 ⁶	3	3
	DC operated S x10 ⁶	4	4
Short time current			
	10s-current A	50	50
Power loss per pole			
	at I _e /AC3 400V W	0,2	0,2
Resistance to shock according to IEC 68-2-27			
Shock time 20ms sine-wave			
AC operated	NO g	2,5	2,5
	NC g	2,5	2,5

1) With reduced control voltage range 0,9 up to 1,0 x U_s and with reduced rated current I_e/AC1 according to I_e/AC3.

Micro Contactors

Data according to IEC 60947-5-1, VDE 0660, EN 60947-5-1

Auxiliary Contacts			Type	K0-04D.. K0-05D..	K0-04L.. K0-05L..
Rated insulation voltage	U_i	VAC		440 ¹⁾	440 ¹⁾
Thermal rated current I_{th} to 440V					
Ambient temperature	40°C	A		5	5
	60°C	A		3	3
Verlustleistung pro Pol	bei I _{th}	W		0,25	0,25
Utilization category AC15					
Rated operational current I _e	220-240V	A		3	3
	380-415V	A		1,5	1,5
	440V	A		1	1
Utilization category DC13					
Rated operational current I _e	24V	A		1	1
				-	-
				-	-
Maximum ambient temperature					
Operation	open	°C		-40 to +60 (+90) ²⁾	
	enclosed	°C			
Storage		°C		-40 to +40	
				-40 to +90	
Short circuit protection					
short-circuit current 1kA, contact welding not accepted max. fuse size	gL (gG)	A		10	10
For contactors with thermal overload relay the device with the smaller admissible control fuse (contactor or thermal overload relay) determines the fuse size.					
Power consumption of coils					
AC operated	inrush	VA		9	9
	sealed	VA		4	4
		W		1,8	1,8
DC operated	inrush	W		2,5	2,5
	sealed	W		2,5	2,5
Operation range of coils					
in multiples of control voltage U _s		AC		0,85 - 1,1	0,85 - 1,1
		DC		0,8 - 1,1	0,8 - 1,1
Switching time at control voltage U _s ±10% ^{3) 4)}					
AC operated	make time	ms		13 - 18	13 - 18
	release time	ms		5 - 10	5 - 10
	arc duration	ms		10 - 15	10 - 15
DC operated	make time	ms		10 - 20	10 - 20
	release time	ms		2 - 10	2 - 10
	arc duration	ms		10 - 15	10 - 15
Cablecross-section					
all connectors	solid	mm ²		0,5 - 1,5	Solder Connector Ø 1,15
	flexible	mm ²		0,5 - 1,5	
	flexible with multicore cable end	mm ²		0,5 - 1,5	
Clamps per pole				2	-
	solid or stranded	AWG		20 - 14	-

1) Suitable at 690V for: earthed-neutral systems, overvoltage category I to III, pollution degree 3 (standard-industry): U_{imp} = 4kV.
Data for other conditions on request.

2) With reduced control voltage range 0,9 up to 1,0 x U_s and with reduced thermal rated current I_{th} to I_e /AC15.

3) Summary switching time = release time + arc duration.

4) Release time of NC make time of NO increase when suppressor units for voltage peak protection are used (Varistor, RC-units, Diode units).

5) Data on request.

Micro Contactors for North America

Data according to UL508

Main Contacts (cULus)		Type	K0-05D.. K0W05D01..	K0-04D..	K0-05L..	K0-04L..
Rated operational current "General Use"		A	12	5	9	5
Rated operational power of three motors at 60Hz (3ph)	110-120V	hp	1/2	-	1/2	-
	200-208V	hp	1	-	1	-
	220-240V	hp	1	-	1	-
	277V	hp	1 1/2	-	1 1/2	-
Rated operational power of AC motors at 60Hz (1ph)	110-120V	hp	1/6	-	1/6	-
	200-208V	hp	1/2	-	1/2	-
	220-240V	hp	3/4	-	3/4	-
Fuse / Short-circuit current		A/kA	30/5	-	30/5	-
Rated voltage		VAC	300	300	300	300
Auxiliary Contacts (cULus)						
	heavy pilot duty	AC	B300	B300	B300	B300
	standard pilot duty	DC	R300	R300	R300	R300

Motor Rating P_n = AC4

380/ 220/
400V 230V
kW kW

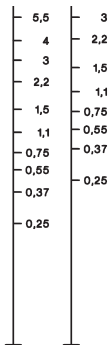

Motor Rating P_n = AC3

380/ 220/
400V 230V
kW kW

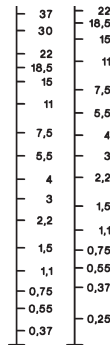

Breaking Current I_a (= I_e = AC1)

A

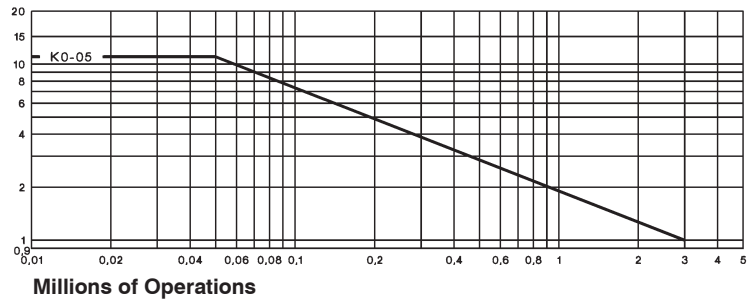

Micro Contactors

Dimensions

AC or DC operated
with screw terminals

K0-04D.. (=)
K0-05D.. (=)

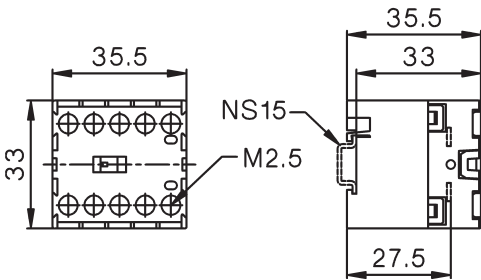

Snap-On Adapter P1039

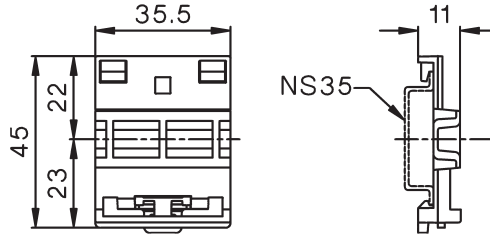

Reversing Contactors
with screw terminals

K0W05D..MC

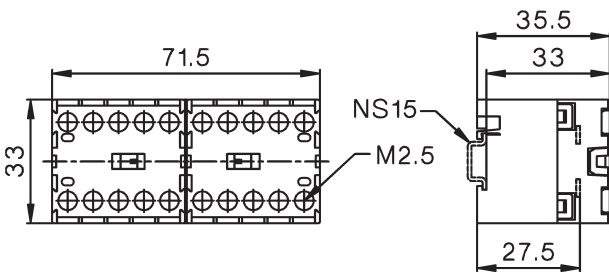

K0...D.. with Snap-On Adapter P1039

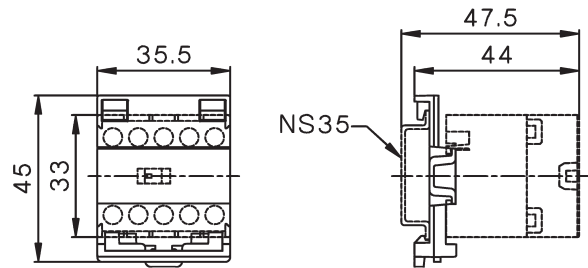

AC or DC operated
with solder connections

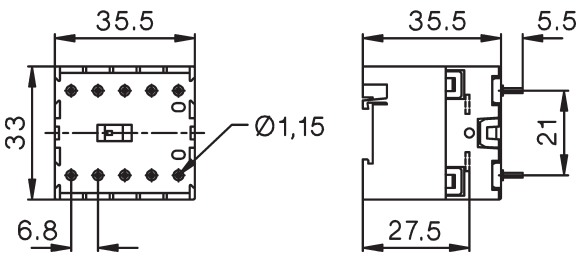

K0-04L.. (=)
K0-05L.. (=)

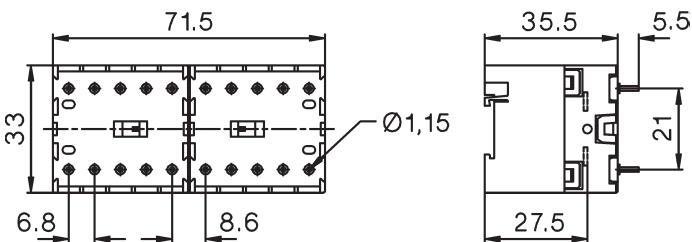

Reversing Contactors
with solder connections

K0W05L..MC



	Mini Contactor Relays 4-pole Auxiliary Contact Blocks	26
	Interface Contactor Relays	27
	Mini Contactors Auxiliary Contact Blocks	28
	Mini Contactors With Fast On Tab Connectors	30
	Mini Contactors With Solder Pins	30
	Coil voltages	30
	Mini Reversing Contactors Auxiliary Contact Blocks	32
	Technical Data	33
	Dimensions	38

Mini Contactor Relays 4-pole

AC Operated

Ratings	Therm. Distinc. Number	Contacts ²⁾ Additional Contact	Type	Coil voltage ¹⁾
AC15				24V 50/60Hz
230V				220-230V 50Hz
A				24V 50/60Hz w. protection ³⁾
				220-230V 50Hz w. protection ³⁾
				24V 50/60Hz 24V= DC
				220-240V 50/60Hz 220V= DC
				Pack Weight pcs. kg/pc.

4-pole, With Screw Terminals



3	2	10	4	-	40E	1 HK..	K1-07D40 ...	10	0,16
3	2	10	3	1	31E	1 HK..	K1-07D31 ...	10	0,16
3	2	10	2	2	22E	1 HK..	K1-07D22 ...	10	0,16

Auxiliary Contact Blocks For Contactor Relays



Ratings	Thermal Rated Current	Contacts ²⁾	Type	Pack pcs.	Weight kg/pc.
AC15					
230V					
A					

Aux. Contact Blocks

HK11 HK02 HK20 HK40 HK22 HK04

Wiring Diagrams

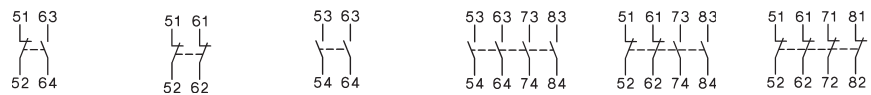



Distinc. Number according to EN50011 for Contactor Relay with Auxiliary Contact Block

K1-07D40	51E	42E	60E	80E	62E	44E
K1-07D31	42Y	33Y	51Y	71Y	53Y	35Y
K1-07D22	33Y	24Y	42Y	62Y	44Y	26Y

Preferable combinations with distinctive letter ".E" according to DIN EN 50011

1) Other coil voltages see page 30
 2) Contacts suitable for electronic circuits, according to EN947-5-4 for rated voltage 24V DC (test ratings 17V DC, 5mA) Mirror contacts acc. IEC60947-4-1 Annex F.
 3) with built-in coil suppressor (varistor)

DC Solenoid Operated

Type	Coil voltage ¹⁾		Contacts ²⁾		Additional Contact Blocks	Pack pcs.	Weight kg/pc.	Wiring Diagrams
	24	24VS	NO	NC				
	24V= DC	24V= DC with protection ²⁾			Distinc. Number acc. to EN50011			

4-pole, With Screw Terminals, Coil 2,5W



K1-07D40= ...	4	-	40E	1 HK..	10	0,19
----------------------	---	---	-----	--------	----	------

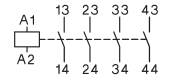

K1-07D31= ...	3	1	31E	1 HK..	10	0,19
----------------------	---	---	-----	--------	----	------

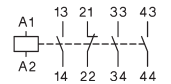

K1-07D22= ...	2	2	22E	1 HK..	10	0,19
----------------------	---	---	-----	--------	----	------

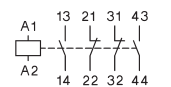

4-pole, With Screw Terminals, Coil 1,5W, 19 to 30V DC with suppressor ³⁾



K1-07D40= 24VR	4	-	-	-	10	0,20
-----------------------	---	---	---	---	----	------

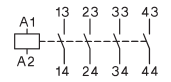

K1-07D31= 24VR	3	1	-	-	10	0,20
-----------------------	---	---	---	---	----	------

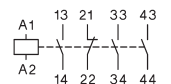

K1-07D22= 24VR	2	2	-	-	10	0,20
-----------------------	---	---	---	---	----	------

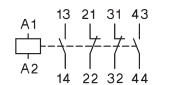

1) Other coil voltages on request
 2) Contacts suitable for electronic circuits, according to EN947-5-4 for rated voltage 24V DC (test ratings 17V DC, 5mA) Mirror contacts acc. IEC60947-4-1 Annex F.
 3) with integrated coil suppressor (Transient Voltage Suppressor Diode)

Mini Contactors

AC Operated

Power Ratings	Rated Current	Aux. Contacts ²⁾		Type	Coil voltage ¹⁾	Pack pcs.	Weight kg/pc.
		Built-in	Additional				
AC2, AC3	AC1				24V 50/60Hz		
380V					220-230V 50Hz		
400V	660V				24V 50/60Hz w. protection ³⁾		
415V	690V	690V			220-230V 50Hz w. protection ³⁾		
kW	kW	A			24VM 24V 50/60Hz 24V= DC		
			NO NC	Type	230VM 220-240V 50/60Hz 220V= DC		



3-pole, With Screw Terminals

4	4	20	1	-	1 HKM..	K1-09D10 ...	10	0,16
5,5	5,5	20	1	-	1 HKM..	K1-12D10 ...	10	0,16

4	4	20	-	1	1HK..	K1-09D01 ...	10	0,16
5,5	5,5	20	-	1	1HK..	K1-12D01 ...	10	0,16

4-pole, With Screw Terminals

4	4	20	-	-	1HK..	K1-09D00-40 ...	10	0,16
5,5	5,5	20	-	-	1HK..	K1-12D00-40 ...	10	0,16

Auxiliary Contact Blocks for Contactors K1-..

Ratings	Thermal Rated Current	Contacts ²⁾		Type	Pack pcs.	Weight kg/pc.
		Built-in	Additional			
AC15						
230V	400V					
A	A	A				
			NO NC			
3	2	10	1 1	HKM11	10	0,04
3	2	10	- 2	HKM02	10	0,04
3	2	10	2 2	HKM22	10	0,04

Aux. Contact Blocks

HKM11

HKM02

HKM22

HK11

HK02

HK40

HK22

Wiring Diagrams

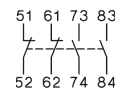
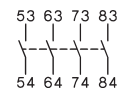
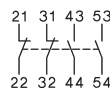

Contactors with Auxiliary Contact Block

Contacts according to EN50012

K1-..D10

21

12

32

-

-

-

-

Contacts according to DIN EN50005

K1-..D01

-

-

-

12

03

41

23

K1-..D00-40

-

-

-

11

02

40

22

Prefer combinations according to EN50012

Suppressor Units for Contactors K1-..



Voltage Range V		Type	Pack pcs.	Weight kg/pc.
12 - 48V AC/DC	1600nF / 22 Ohm	RC-K1 24	10	0,01
48 - 127V AC/DC	680nF / 270 Ohm	RC-K1 110	10	0,01
110 - 250V AC/DC	220nF / 2200 Ohm	RC-K1 230	10	0,01

1) Other coil voltages see page 30

2) Contacts suitable for electronic circuits, according to EN947-5-4 for rated voltage 24V DC (test ratings 17V DC, 5mA) Mirror contacts acc. IEC60947-4-1 Annex F.



3) with built-in coil suppressor (varistor)

DC Solenoid Operated

Type

Coil voltage ¹⁾
24 24V= DC
24VS 24V= DC with protection ³⁾



Aux. Contacts ²⁾
 Built in
 
 NO NC

Additional Overload Relay
 see page 114
 Type

Pack pcs. Weight kg/pc.

Wiring Diagrams



3-pole, With Screw Terminals, Coil 2,5W

K1-09D10= ...	1	-	1 HKM..	U12/16..K1	10	0,19
K1-12D10= ...	1	-	1 HKM..	U12/16..K1	10	0,19

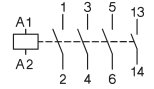

K1-09D01= ...	-	1	1 HK..	U12/16..K1	10	0,19
K1-12D01= ...	-	1	1 HK..	U12/16..K1	10	0,19

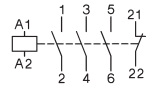

4-pole, With Screw Terminals, Coil 2,5W

K1-09D00-40= ...	-	-	-	U12/16..K1	10	0,19
K1-12D00-40= ...	-	-	-	U12/16..K1	10	0,19

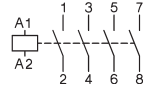

3-pole, With Screw Terminals, Coil 1,5W, 19 to 30V DC with suppressor ³⁾

K1-09D10=24VR	1	-	-	U12/16..K1	10	0,20
----------------------	---	---	---	------------	----	------

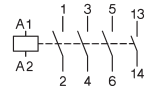

K1-09D01= 24VR -	-	1	-	U12/16..K1	10	0,20
-------------------------	---	---	---	------------	----	------

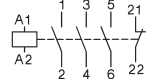

1) Other coil voltages on request
 2) Contacts suitable for electronic circuits, according to EN947-5-4 for rated voltage 24V DC (test ratings 17V DC, 5mA) Mirror contacts acc. IEC60947-4-1 Annex F.
 3) with integrated coil suppressor (Transient Voltage Suppressor Diode)

Mini Contactors

AC Operated

Power Ratings	Rated Current	Aux. Contacts ²⁾		Type	Coil voltage ¹⁾
		Built in	Additional		
AC2, AC3	AC1				24V 50/60Hz
380V					220-230V 50Hz
400V	660V				24V 50/60Hz w. protection ²⁾
415V	690V	690V			220-230V 50Hz w. protection ²⁾
kW	kW	A			24V 50/60Hz 24V DC
			NO NC	Type	230VM 220-240V 50/60Hz 220V DC
					Pack Weight pcs. kg/pc.

3-pole, with Fast On Tab Connectors 1 x 6,3mm or 2 x 2,8mm



4	4	16	1	-	1 HKM..	K1-09F10 ...	10	0,16
4	4	16	-	1	1 HK..	K1-09F01 ...	10	0,16

3-pole, with Solder Pins Ø1,15 for Printed Circuit Applications



4	4	16	1	-	-	K1-09L10 ...	10	0,16
4	4	16	-	1	-	K1-09L01 ...	10	0,16

4-pole, with Solder Pins Ø1,15 for Printed Circuit Applications

4	4	16	-	-	-	K1-09L00-40 ...	10	0,16
---	---	----	---	---	---	------------------------	----	------

Suffix to contactor type e.g. K1-09D10 24	Voltage Marking at the coil for		Rated Control Voltage U _s range for 50Hz				for 60Hz	
	50Hz	60Hz	min.	max.	min.	max.	min.	max.
	V	V	V	V	V	V	V	V
12	12	12	11	12	12	12		
24	24	24	22	24	24	24		
42	42	42	38,5	42	42	42		
48	48	48	48	50	48	52		
90	100	100	90	100	100	105		
95	95-100	105-110	95	100	105	110		
100	100	110-115	100	105	110	115		
105	105-110	115-120	105	110	115	120		
110	110-115	120-125	110	115	120	125		
180	200	200	185	200	200	210		

Suffix to contactor type e.g. K1-09D10 230	Voltage Marking at the coil for		Rated Control Voltage U _s range for 50Hz				for 60Hz	
	50Hz	60Hz	min.	max.	min.	max.	min.	max.
	V	V	V	V	V	V	V	V
200	200	200-220	195	205	200	220		
210	205-215	220-230	205	215	220	230		
220	210-220	220-240	210	220	220	240		
230	220-230	230-250	220	230	230	250		
240	230-240	240-260	230	240	240	260		
400	380-400	400-440	380	400	400	440		
500	475-500	520-545	475	500	520	545		
550	525-550	600	525	550	570	600		

Standard voltages in bold type letters
Operating range of magnet-coils: 0,85 x U_s (min. value of rated control voltage) up to 1,1 x U_s (max. value of rated control voltage)

Coil not exchangeable

1) Other coil voltages see page 28

2) Contacts suitable for electronic circuits, according to EN947-5-4 for rated voltage 24V DC (test ratings 17V DC, 5mA) Mirror contacts acc. IEC60947-4-1 Annex F.

3) with built-in coil suppressor (varistor)

DC Solenoid Operated

Type

Coil voltage ¹⁾	Aux. Contacts ²⁾	Additional Overload Relay see pages 115, 117	Pack pcs.	Weight kg/pc.
24 24V= DC	Built in			
24VS 24V= DC with protection ³⁾	NO NC	Type		

3-pole, with Fast On Tab Connectors 1 x 6,3mm or 2 x 2,8mm



K1-09F10= . . .	1	-	1 HKM.. ⁴⁾	10	0,19
------------------------	---	---	-----------------------	----	------

Wiring Diagrams

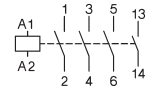

K1-09F01= . . .	-	1	1 HK.. ⁴⁾	10	0,19
------------------------	---	---	----------------------	----	------

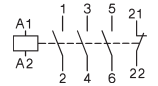

3-pole, with Solder Pins Ø1,15 for Printed Circuit Applications



K1-09L10= . . .	1	-	-	10	0,19
------------------------	---	---	---	----	------

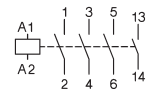

K1-09L01= . . .	-	1	-	10	0,19
------------------------	---	---	---	----	------

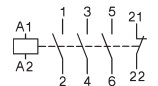

4-pole, with Solder Pins Ø1,15 for Printed Circuit Applications

K1-09L00-40= . . .	-	-	-	10	0,19
---------------------------	---	---	---	----	------

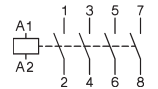

1) Other coil voltages on request
 2) Contacts suitable for electronic circuits, according to EN947-5-4 for rated voltage 24V DC (test ratings 17V DC, 5mA) Mirror contacts acc. IEC60947-4-1 Annex F.
 3) with integrated coil suppressor (Transient Voltage Suppressor Diode)
 4) U12/16E K3 with U12SMK3 for single mounting

Mini Reversing Contactors, Mechanical Interlocked

AC Operated

Power Ratings	Rated Current	AC2, AC3 AC1	Aux. Contacts ²⁾		Type	Coil voltage ¹⁾	Pack pcs.	Weight kg/pc.
			Built-in	Additional on left hand side Contactor				
380V						24V 50/60Hz		
400V	660V					220-230V 50Hz		
415V	690V	690V				24V 50/60Hz w. protection ³⁾		
kW	kW	A				220-230V 50Hz w. prot. ³⁾		
						24V 50/60Hz 24V DC		
						220-240V 50/60Hz 220V DC		

3-pole, with Screw Terminals



4	4	20	-	1	HKM11V	HKM11X	K1W09D01MC ...	1	0,32
5,5	5,5	20	-	1	HKM11V	HKM11X	K1W12D01MC ...	1	0,32
4	4	20	1	-	-	HKM..	K1W09D10MC ...	1	0,32
5,5	5,5	20	1	-	-	HKM..	K1W12D10MC ...	1	0,32

4-pole, with Screw Terminals

4	4	20	-	-	-	HKM..	K1W09D00-40MC ..	1	0,32
5,5	5,5	20	-	-	-	HKM..	K1W12D00-40MC ..	1	0,32

3-pole, with Solder Pins Ø1,15 for Printed Circuit Applications



4	4	16	-	1	-	-	K1W09L01MC ...	1	0,32
4	4	16	1	-	-	-	K1W09L10MC ...	1	0,32

Auxiliary Contact Blocks for Mini Reversing Contactors K1-..

Ratings	AC15 230V A	400V A	Thermal Rated Current A	Contacts ²⁾		Type	Pack pcs.	Weight kg/pc.
				NO	NC			
3	2		10	1	1	HKM11V	10	0,04
3	2		10	1	1	HKM11X	10	0,04



Aux. Contact Blocks

HKM11V HKM11X

Wiring Diagrams

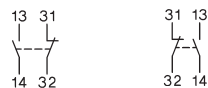

Reversing Starter Connector



For Reversing Starter Types, incl. Coil Connector

Type	Pack pcs.	Weight kg/pc.
K1W09D..MC, K1W12D..MC	1	0,01

1) Other coil voltages see page 30

2) Contacts suitable for electronic circuits, according to EN947-5-4 for rated voltage 24V DC (test ratings 17V DC, 5mA) Mirror contacts acc. IEC60947-4-1 Annex F.

3) with built-in coil suppressor (varistor)

DC Solenoid Operated

Type

24
24VS ↓
 Coil voltage ¹⁾
 24V= DC
 24V= DC with
 protection ²⁾

Additional
 Overload
 Relay
 see
 page 114
 Type

Pack pcs. Weight kg/pc.

Wiring Diagrams



3-pole, with Screw Terminals

K1W09D01MC= ...	U12/16..K1	1	0,32
K1W12D01MC= ...	U12/16..K1	1	0,32
K1W09D10MC= ...	U12/16..K1	1	0,32
K1W12D10MC= ...	U12/16..K1	1	0,32

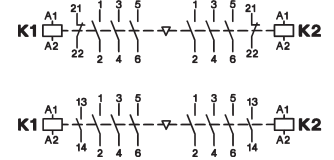

4-pole, with Screw Terminals

K1W09D00-40MC= ..	U12/16..K1	1	0,32
K1W12D00-40MC= ..	U12/16..K1	1	0,32

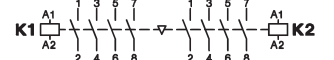

3-pole, with Solder Pins Ø1,15 for Printed Circuits Applications



K1W09L01MC= ...	-	1	0,32
K1W09L10MC= ...	-	1	0,32

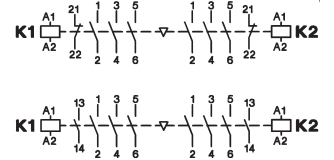

1) Other coil voltages on request
 2) with integrated coil suppressor (Transient Voltage Suppressor Diode)

Mini Contactors

Data according to IEC 947-4-1, VDE 0660, EN 60947-4-1

Main Contacts	Type	K1-09D..	K1-09F..	K1-09L..	K1-12D..
Rated insulation voltage U_i	V AC	690 ¹⁾	690 ¹⁾	690 ²⁾	690 ¹⁾
Making capacity I_{eff}	at $U_e = 690V$ AC	A	165	165	165
Breaking capacity I_{eff} $\cos\phi = 0,65$	400V AC	A	100	100	100
	500V AC	A	90	90	90
	690V AC	A	80	80	80
Utilization category AC1					
Switching of resistive load					
Rated operational current $I_e (=I_{th})$ at 40°C, open	A	20	16	16	20
Rated operational power of three-phase resistive loads 50-60Hz, $\cos\phi = 1$	230V kW	7,9	6	6	7,9
	240V kW	8,3	6,5	6,5	8,3
	400V kW	13,8	11	11	13,8
	415V kW	14,3	11,5	11,5	14,3
Rated operational current $I_e (=I_{th})$ at 60°C, enclosed	A	16	12	12	16
Rated operational power of three-phase resistive loads 50-60Hz, $\cos\phi = 1$	230V kW	6,3	4,5	4,5	6,3
	240V kW	6,7	5	5	6,7
	400V kW	11	8	8	11
	415V kW	11,5	8,5	8,5	11,5
Minimum cross-section of conductor at load with $I_e (=I_{th})$	mm ²	2,5	2,5	-	2,5
Utilization category AC2 and AC3					
Switching of three-phase motors					
Rated operational current I_e open and enclosed	220V A	12	12	12	15
	230V A	11,5	11,5	11,5	14,5
	240V A	11	11	11	14
	380-400V A	9	9	9	12
	415-440V A	8	8	8	11
	500V A	7	7	7	9
	660-690V A	5	5	5	6,5
Rated operational power of three-phase motors 50-60Hz	220-240V kW	3	3	3	4
	380-440V kW	4	4	4	5,5
	500-690V kW	4	4	4	5,5
Utilization category AC4					
Switching of squirrel cage motors, inching					
Rated operational current I_e open and enclosed	220V A	12	12	12	15
	230V A	11,5	11,5	11,5	14,5
	240V A	11	11	11	14
	380-400V A	9	9	9	12
	415-440V A	8	8	8	11
	500V A	7	7	7	9
	660-690V A	5	5	5	6,5
Rated operational power of three-phase motors 50-60Hz	220-240V kW	3	3	3	4
	380-440V kW	4	4	4	5,5
	500-690V kW	4	4	4	5,5
Utilization category AC5a					
Switching of gas discharge lamps					
Rated operational current I_e per pole at 220/230V					
Fluorescent lamps, uncompensated and serial compensated					
	A	10	10	10	10
parallel compensated					
	A	2	2	2	2
dual-connection					
	A	16	16	16	16
Metal halide lamps ³⁾ , uncompensated					
	A	10	10	10	10
parallel compensated					
	A	2	2	2	2
Mercury-vapour lamps ⁴⁾ , uncompensated					
	A	16	16	16	16
parallel compensated					
	A	2	2	2	2
Mixed light lamps ⁵⁾					
	A	16	61	16	16
LED-Lamps					
consider the inrush current of the lamp ballast and $\cos\phi$ of the lamp	max. lamps per pole ($I_{nLED} \leq I_{th}$)	= $\frac{\text{inrush current of contactor}}{\text{inrush current of lamp/EVG}}$			
max inrush current of contactor	A	233	233	233	233

Utilization category AC5b Switching of incandescent lamps ⁶⁾

Rated operational current I_e
per pole at 220/230V

A 8 8 8 8

1) Suitable at 690V for: earthed-neutral systems, overvoltage category I to IV, pollution degree 3 (standard-industry): $U_{imp} = 8kV$.
Data for other conditions on request.

2) Suitable at 690V for pollution degree 2, $U_{imp} = 6kV$.

Pollution degree 3 $U_i = 690V$ non-tracking of the printed circuit CTI ≥ 600

Pollution degree 3 $U_i = 500V$ non-tracking of the printed circuit CTI ≥ 400

Pollution degree 3 $U_i = 400V$ non-tracking of the printed circuit CTI ≥ 100

3) Metal halide lamps and sodium-vapour lamps (high- and low-pressure lamps)

4) High-pressure lamps

5) Blended lamps, containing a mercury high-pressure unit and a tungsten helix in a fluorescent glass bulb (daylight lamps)

6) Current inrush approx. $16 \times I_e$

Mini Contactors

Data according to IEC 947-4-1, VDE 0660, EN 60947-4-1

Main Contacts			Type	K1-09D..	K1-09F..	K1-09L..	K1-12D..
Utilization category DC1							
Switching of resistive load							
	1 pole	24V	A	20	16	16	20
		60V	A	20	16	16	20
		110V	A	5	5	5	5
		220V	A	0,6	0,6	0,6	0,6
	3 poles in series	24V	A	20	20	20	20
		60V	A	20	20	20	20
		110V	A	20	20	20	20
		220V	A	16	16	16	16
Utilization category DC3 and DC5							
Switching of shunt motors and series motors							
	1 pole	24V	A	20	16	16	20
		60V	A	5	5	5	5
		110V	A	1	1	1	1
		220V	A	0,15	0,15	0,15	0,15
	3 poles in series	24V	A	20	16	16	20
		60V	A	20	16	16	20
		110V	A	20	16	16	20
		220V	A	2	2	2	2
Maximum ambient temperature							
Operation			open °C	-40 to +60 (+90) ¹⁾			
			enclosed °C				
with thermal overload relay			open °C	-25 to +60			
			enclosed °C				
Storage			°C	-50 to +90			
Short circuit protection							
for contactors without thermal overload relay							
Coordination-type "1" according to IEC 947-4-1							
Contact welding without hazard of persons							
max. fuse size			gL (gG) A	40	40	40	40
Coordination-type "2" according to IEC 947-4-1							
Light contact welding accepted							
max. fuse size			gL (gG) A	25	25	25	25
Contact welding not accepted							
max. fuse size			gL (gG) A	10	10	10	10
For contactors with thermal overload relay the device with the smaller admissible backup fuse (contactor or thermal overload relay) determines the fuse size.							
Cable cross-sections							
for contactors without thermal overload relay							
main connector			solid or stranded mm ²	0,5 - 2,5	Fast on	Solder connector	0,5 - 2,5
			flexible mm ²	0,5 - 2,5	1x 6,3 x 0,8	Ø 1,15	0,5 - 2,5
Cables per clamp			flexible with multicore cable end mm ²	0,5 - 1,5	or	-	0,5 - 1,5
				2	2x 2,8 x 0,8		2
			solid or stranded AWG	18 - 14			18 - 14
Frequency of operations z							
Contactors without thermal overload relay							
			without load 1/h	10000	10000	10000	10000
			AC3, I _e 1/h	600	600	600	700
			AC4, I _e 1/h	120	120	120	150
			DC3, I _e 1/h	600	600	600	700
Mechanical life							
AC operated			S x 10 ⁶	5	5	5	5
DC operated			S x 10 ⁶	15	15	15	15
Short time current							
10s-current			A	96	96	96	120
Power loss per pole							
at I _e /AC3 400V			W	0,15	0,15	0,15	0,25
Resistance to shock according to IEC 68-2-27							
Shock time 20ms sine-wave							
AC operated							
			NO g	5	5	5	5
			NC g	5	5	5	5
DC operated							
			NO g	8	8	8	8
			NC g	6	6	6	6

1) With reduced control voltage range 0,9 up to 1,0 x U_s and with reduced rated current I_e/AC1 according to I_e/AC3

Mini Contactors

Data according to IEC 947-5-1, VDE 0660, EN 60947-5-1

Auxiliary Contacts			Type	K1-07D.. K1-09D.. K1-12D..	K1-07D..= K1-09D..= K1-12D..=	K1-07D..= 24VR K1-09D..= 24VR	K1-09F.(=)	K1-07L..(=) K1-09L..(=)	HK..
Rated insulation voltage U_i			V AC	690 ¹⁾	690 ¹⁾	690 ¹⁾	690 ¹⁾	690 ²⁾	690 ¹⁾
Thermal rated current I_{th} to 690V									
Ambient temperature			40°C A	10	10	10	10	10	10
			60°C A	6	6	6	6	6	6
Power loss per pole			at I_{th} W	0,5	0,5	0,5	0,5	0,5	0,5
Utilization category AC15									
Rated operational current I_e			220-240V A	3	3	3	3	3	3
			380-415V A	2	2	2	2	2	2
			440V A	1,6	1,6	1,6	1,6	1,6	1,6
			500V A	1,2	1,2	1,2	1,2	1,2	1,2
			660-690V A	0,6	0,6	0,6	0,6	0,6	0,6
Utilization category DC13									
Rated operational current I_e			60V A	2	2	2	2	2	2
			110V A	0,4	0,4	0,4	0,4	0,4	0,4
			220V A	0,1	0,1	0,1	0,1	0,1	0,1
Maximum ambient temperature									
Operation			open °C	-40 to +60 (+90) ³⁾					
			enclosed °C	-40 to +40					
Storage			°C	-40 to +90					
Short circuit protection									
short-circuit current 1kA, contact welding not accepted max. fuse size			gL (gG) A	20	20	20	20	20	20
For contactors with thermal overload relay the device with the smaller admissible control fuse (contactor or thermal overload relay) determines the fuse size.									
Power consumption of coils									
AC operated			inrush VA	25	-	-	25	25	-
			sealed VA	4 - 5	-	-	4 - 5	4 - 5	-
			W	1,2	-	-	1,2	1,2	-
DC operated			inrush W	-	2,5	1,5	2,5	2,5	-
and ...VM (AC/DC)			sealed W	-	2,5	1,5	2,5	2,5	-
Operation range of coils									
in multiples of control voltage U_s				0,85 - 1,1	0,8 - 1,1	19 - 30V DC	0,85 - 1,1	0,85 - 1,1	-
Switching time at control voltage $U_s \pm 10\%$ ⁴⁾⁵⁾									
AC operated			make time ms	15 - 19	-	-	15 - 19	15 - 19	-
			release time ms	8 - 25	-	-	8 - 25	8 - 25	-
			arc duration ms	10 - 15	-	-	10 - 15	10 - 15	-
DC operated			make time ms	-	15 - 25	15 - 25	15 - 25	15 - 25	-
			release time ms	-	8 - 25	8 - 25	8 - 25	8 - 25	-
			arc duration ms	-	10 - 15	10 - 15	10 - 15	10 - 15	-
Cable cross-section									
all connectors			solid mm ²	0,5 - 2,5	0,5 - 2,5	0,5 - 2,5	Fast on	Solder connector	0,5 - 2,5
			flexible mm ²	0,5 - 2,5	0,5 - 2,5	0,5 - 2,5	1x 6,3 x 0,8	Ø 1,15	0,5 - 2,5
			flexible with multicore cable end mm ²	0,5 - 1,5	0,5 - 1,5	0,5 - 1,5	or		0,5 - 1,5
							2x 2,8 x 0,8		
Clamps per pole				2	2	2	-	-	2
			solid or stranded AWG	18 - 14	18 - 14	18 - 14			18 - 14

1) Suitable at 690V for: earthed-neutral systems, overvoltage category I to IV, pollution degree 3 (standard-industry): $U_{imp} = 8kV$.
Data for other conditions on request.

2) Suitable at 690V for pollution degree 2, $U_{imp} = 6kV$.
Pollution degree 3 $U_i = 690V$ non-tracking of the printed circuit CTI ≥ 600
Pollution degree 3 $U_i = 500V$ non-tracking of the printed circuit CTI ≥ 400
Pollution degree 3 $U_i = 400V$ non-tracking of the printed circuit CTI ≥ 100

3) With reduced control voltage range 0,9 up to 1,0 x U_s and with reduced thermal rated current I_{th} to I_e /AC15

4) Summary switching time = release time + arc duration

5) Release time of NC make time of NO increase when suppressor units for voltage peak protection are used (Varistor, RC-units, Diode units).

Mini Contactors for North America

Data according to UL508

Main Contacts (cULus)		Type	K1-09D.. K1W09D01	K1-09F..	K1-09L..	K1-07D..	K1-12D.. K1W12D01	HK..
Rated operational current "General Use"		A	15	15	20	10	20	10
Rated operational power of three-phase motors at 60Hz (3ph)	110-120V	hp	1½	1½	1½	-	2	-
	200-208V	hp	3	3	3	-	3	-
	220-240V	hp	3	3	3	-	3	-
	440-480V	hp	5	5	5	-	7½	-
	550-600V	hp	7½	7½	7½	-	10	-
Rated operational power of AC motors at 60Hz (1ph)	110-120V	hp	½	½	½	-	¾	-
	200-208V	hp	1	1	1	-	1½	-
	220-240V	hp	1½	1½	1½	-	2	-
Fuse / Short-circuit current		A/kA	30/5	30/5	30/5	-	30/5	-
Rated voltage		V AC	600	600	600 ¹⁾	600	600	600
Auxiliary Contacts (cULus)		heavy pilot duty	AC	A600	A600	A600	A600	A600
		standard pilot duty	DC	Q600	Q600	Q600	Q600	Q600

Motor Rating P_n = AC4

660/690V	500V	380/400V	220/230V
110	75	55	30
90	55	45	22
75	45	37	18,5
55	37	30	15
45	30	22	11
37	22	18,5	7,5
30	18,5	15	5,5
22	15	11	4
18,5	11	7,5	3
15	7,5	5,5	2,2
11	5,5	4	1,5
7,5	4	3	1,1
5,5	3	2,2	0,75
4	2,2	1,5	0,55
3	1,5	1,1	0,37
2,2	1,1	0,75	0,25
1,5	0,75	0,55	
1,1	0,55	0,37	
0,75	0,37	0,25	
0,55	0,25		
0,37			
0,25			

Motor Rating P_n = AC3

660/690V	500V	380/400V	220/230V
600	400	315	200
600	315	250	160
400	250	200	132
315	200	160	110
250	160	132	90
200	132	110	75
160	110	90	55
132	90	75	45
110	75	55	37
90	55	45	30
75	45	37	22
55	37	30	18,5
45	30	22	15
37	22	18,5	11
30	18,5	15	7,5
22	15	11	5,5
18,5	11	7,5	4
15	7,5	5,5	3
11	5,5	4	2,2
7,5	4	3	1,5
5,5	3	2,2	1,1
4	2,2	1,5	0,75
3	1,5	1,1	0,55
2,2	1,1	0,75	0,37
1,5	0,75	0,55	0,25
1,1	0,55	0,37	
0,75	0,37	0,25	
0,55	0,25		
0,37			
0,25			

Breaking Current I_a (= I_e = AC1)

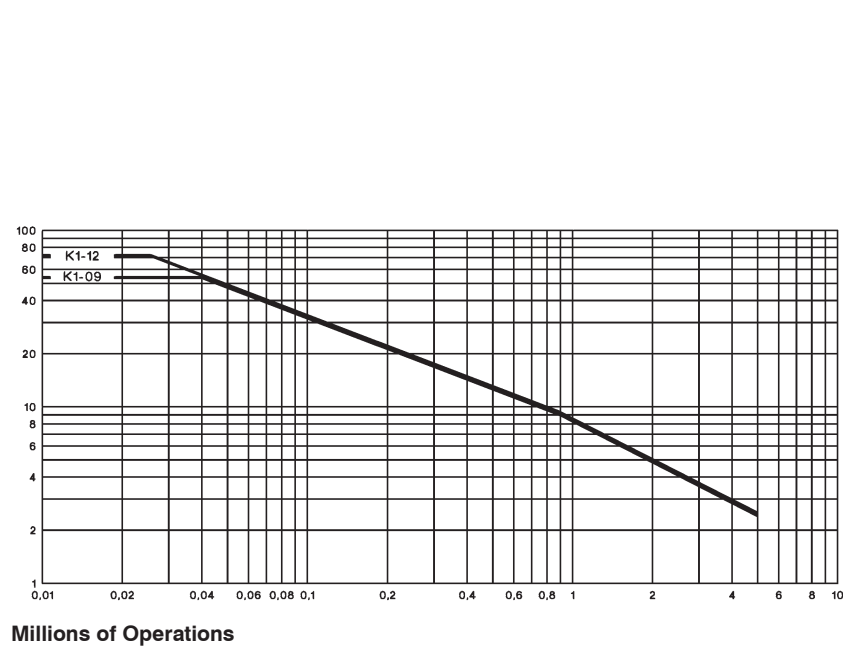

1) Pollution degree	CTI - PWB	U _i
2	≥ 100	600V
3	≥ 400	480V
3	100 - 400	240V

Contactors, Motor-Starters
 Circuit Breakers
 Manual Motor-Starters
 Switches
 AC-Main Switches
 DC-Switch Disconnectors
 Push Buttons
 Representatives, Suppliers

Mini Contactors

Dimensions

AC and DC operated
with screw terminals

K1-07D..
K1-09D..
K1-12D..

with fast on terminals

K1-07F..
K1-09F..

AC and DC operated
with solder connections
K1-07L..
K1-09L..

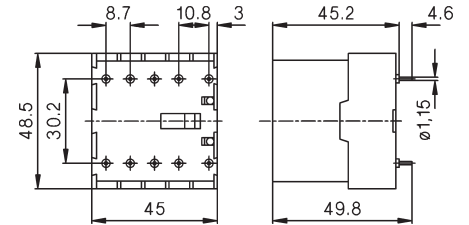
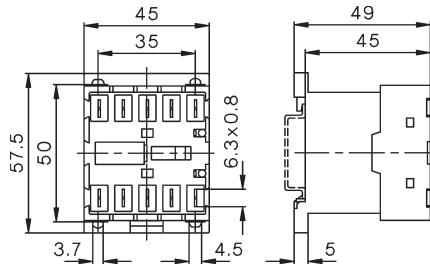
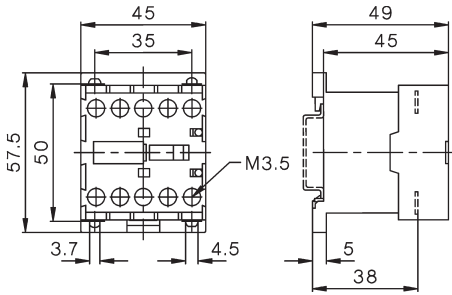

Auxiliary Contact Blocks

HK..

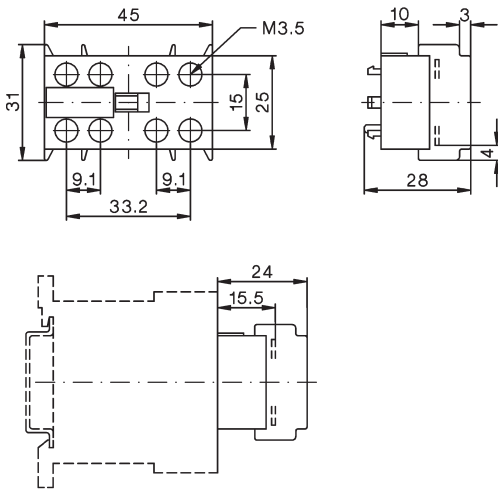

Suppressor Units

RC-K1

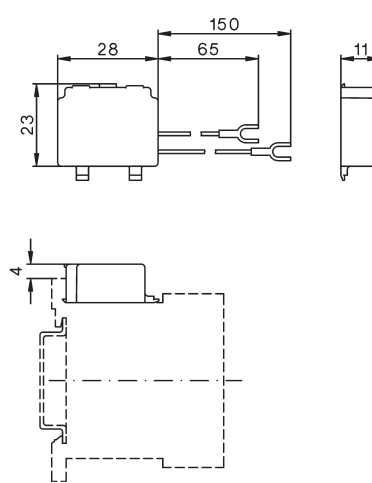

Reversing Contactors

K1W09D..MC
K1W12D..MC

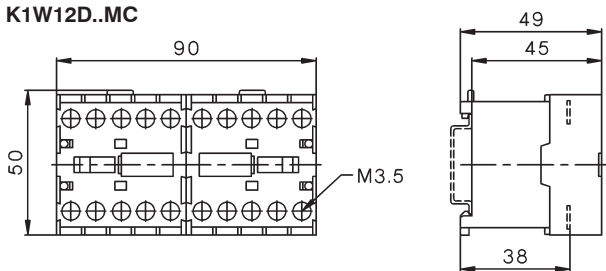

Reversing Contactors

K1W09L..MC

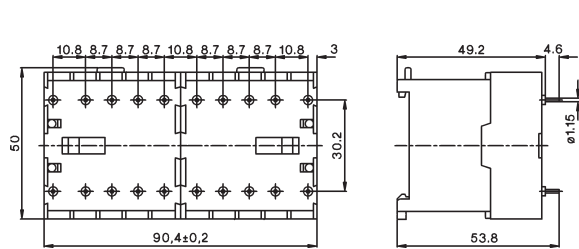

K1-09 + U12/16.. K1
K1-12

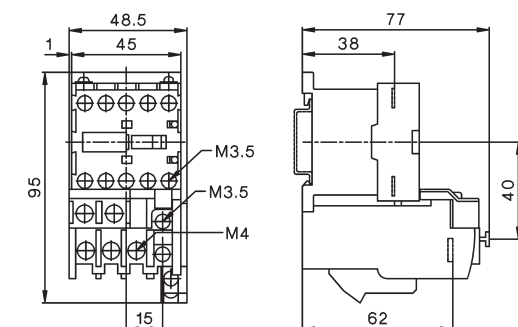

K1W09D..MC + U12/16E K1
K1W09D..MC + U12/16E K1

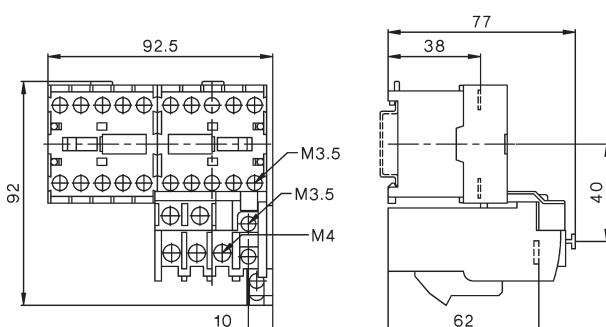



Contactor Relays 4-pole, AC Operated

40



Auxiliary Contact Blocks 1-pole

40



Contactor Relays 4-pole, DC Operated

41



Technical Data

42

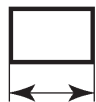

Dimensions

44

Contactors Relays

AC Operated

Ratings		Contacts				Type	Coil voltage ¹⁾		
AC15	Therm. Rated Current	Built-in	Distinc. Number acc. to	Additional Contact Blocks		24	110	230	400
230V	400V						24V 50/60Hz	110V 50Hz	110-120V 60Hz
A	A	I_{th}	NO NC	EN50011	Type			220-240V 50Hz	230-264V 60Hz
								380-415V 50Hz	400-440V 60Hz
									Pack Weight pcs. kg/pc.



4-pole, contacts suitable for electronic circuits according to EN947-5-4²⁾

4	2	10	4	-	40E	max. 4	K3-07ND40 ...	1	0,22
4	2	10	3	1	31E	HN..	K3-07ND31 ...	1	0,22
4	2	10	2	2	22E		K3-07ND22 ...	1	0,22
4	2	10	-	4	04E		K3-07ND04 ...	1	0,22

Auxiliary Contact Blocks ³⁾

Ratings		Thermal Rated Current	Contacts ²⁾				Type	Pack pcs.	Weight kg/pc.
AC15	230V	400V	NO	NC	EM	LB			
A	A	A							



1-pole, contacts suitable for electronic circuits according to EN947-5-4²⁾

3	2	10	1	-	-	-	HN10	10	0,02
3	2	10	-	1	-	-	HN01	10	0,02
3	2	10	-	-	1	-	HN10U	10	0,02
3	2	10	-	-	-	1	HN01U	10	0,02

1-pole, for high switching capacity

6	3	25	1	-	-	-	HA10	10	0,03
6	3	25	-	1	-	-	HA01	10	0,03

Accessories see page 52 - 55

1) Other coil voltages see page 57

2) Contacts suitable for electronic circuits, according to EN947-5-4 for rated voltage 24V DC (test ratings 17V DC, 5mA) Mirror contacts acc. IEC60947-4-1 Annex F.

3) Technical Data see page 62

DC Operated

Type	Coil voltage ¹⁾		Contacts			Pack pcs.	Weight kg/pc.	Wiring Diagrams
	24	48	Built-in	Distinc. Number acc. to	Additional Contact Blocks			
	24V DC	48V DC						
	110V DC	220V DC						
			NO	NC	EN50011	Type		



3W Coil power, for high switching capacity ³⁾

KG3-07A40 ...	4	-	40E	max. 4	1	0,53
KG3-07A31 ...	3	1	31E	HN..	1	0,53
KG3-07A22 ...	2	2	22E	oder	1	0,53
KG3-07A04 ...	-	4	04E	HA..	1	0,53

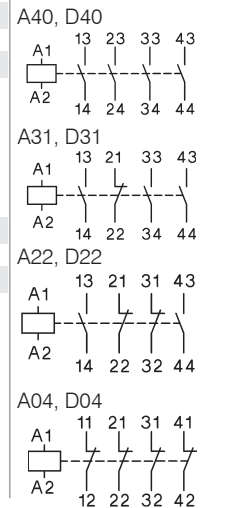

3W Coil power, for electronic circuits ²⁾³⁾

KG3-07D40 ...	4	-	40E	max. 4	1	0,53
KG3-07D31 ...	3	1	31E	HN..	1	0,53
KG3-07D22 ...	2	2	22E		1	0,53
KG3-07D04 ...	-	4	04E		1	0,53

with double winding coil, for electronic circuits ²⁾



K3-07ND40= ...	4	-	40E	max. 3	1	0,25
K3-07ND31= ...	3	1	31E	HN..	1	0,25
K3-07ND22= ...	2	2	22E		1	0,25
K3-07ND04= ...		-4	04E		1	0,25

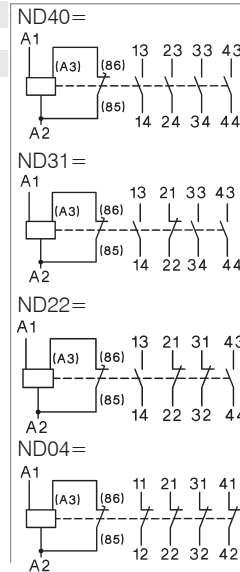

1) Other coil voltages on request

2) Contacts suitable for electronic circuits, according to EN947-5-4 for rated voltage 24V DC (test ratings 17V DC, 5mA) Mirror contacts acc. IEC60947-4-1 Annex F.

3) with integrated coil suppressor (Transient Voltage Suppressor Diode)

Contactors Relays

Data according to IEC 947-5-1, VDE 0660, EN 60947-5-1

			Type	K3-07ND	K3-07ND=	KG3-07A	KG3-07D
Rated insulation voltage $U_i^{1)}$			V AC	690	690	690	690
Thermal rated current I_{th} to 690V							
Ambient temperature			40°C A	10	10	20	10
			60°C A	6	6	16	6
Frequency of operations z			1/h	10000	10000	10000	10000
Mechanical life			S x 10 ⁶	10	10	10	50
Utilization category AC15							
Rated operational current I_e			220-240V A	4	4	12	4
			380-415V A	2	2	4	2
			440V A	1,6	1,6	4	1,6
			500V A	1,2	1,2	3	1,2
			660-690V A	0,6	0,6	1	0,6
Utilization category DC13							
Rated operational current I_e			24-60V A	3,5	3,5	8	3,5
per pole			110V A	0,5	0,5	1	0,5
			220V A	0,1	0,1	0,1	0,1
Power consumption of coils							
AC operated			inrush VA	30 - 45	-	-	-
			sealed VA	7 - 10	-	-	-
			W	2,6 - 3	-	-	-
DC operated			inrush W	-	75	3	3
			sealed W	-	2	3	3
Operation range of coils							
in multiples of control voltage U_s				0,85 - 1,1	0,8 - 1,1	0,8 - 1,1	0,8 - 1,1
Switching time at control voltage $U_s \pm 10\%$							
make time			ms	8 - 16	8 - 16	65 - 85	65 - 85
release time			ms	5 - 13	5 - 13	20 - 30 ³⁾	20 - 30 ³⁾
Maximum ambient temperature							
Operation			open °C	-40 to +60 (+90) ²⁾			
			enclosed °C	-40 to +40			
Storage			°C	-40 to +90			
Short circuit protection							
short-circuit current 1kA, contact welding not accepted							
max. fuse size			gL (gG) A	20	20	25	20
Cable cross-section							
Connector			solid mm ²	0,75 - 6			
			flexible mm ²	1 - 4			
			flexible with multicore cable end mm ²	0,75 - 4			
Magnet coil			solid mm ²	0,75 - 2,5			
			flexible mm ²	0,75 - 2,5			
			flexible with multicore cable end mm ²	0,5 - 1,5			
Clamps per pole				2			
Connector			solid AWG	18 - 10			
			flexible AWG	18 - 10			
Clamps per pole				2			
Magnet coil			solid AWG	14 - 12			
			flexible AWG	18 - 12			
Clamps per pole				2			

Data according to UL508

Rated operational current "General Use"			A	10	10	20	10
Rated operational voltage			max. V AC	600	600	600	600
Auxiliary Contacts heavy pilot duty				A600	A600	A600	A600

1) Suitable at 690V for: earthed-neutral systems, overvoltage category I to IV, pollution degree 3 (standard-industry): $U_{imp} = 8kV$.

Data for other conditions on request.

2) With reduced control voltage range 0,9 up to 1,0 x U_s and with reduced thermal rated current I_{th} according to I_e /AC15

3) with built-in coil suppressor

Contactor Relays

Position of Terminals

AC operated

K3-07ND22

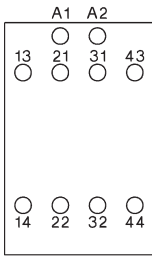

K3-07ND31

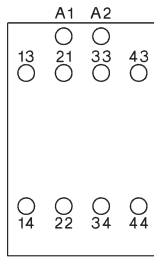

K3-07ND40

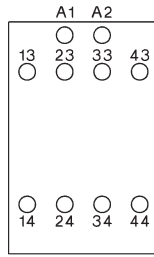

K3-07ND04

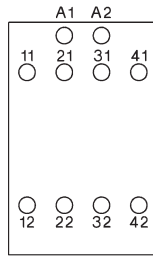

DC operated with double wound coil

K3-07ND22=

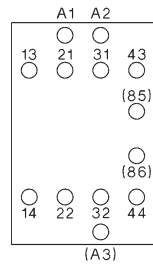

K3-07ND31=

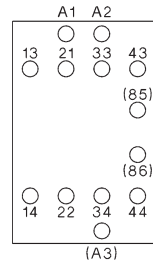

K3-07ND40=

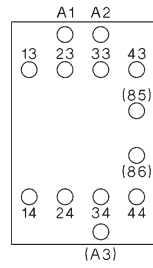

K3-07ND04=

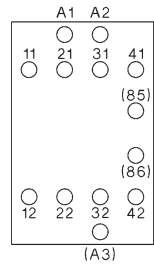

DC solenoid operated

KG3-07A22
KG3-07D22

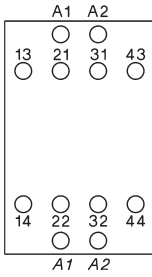

KG3-07A31
KG3-07D31

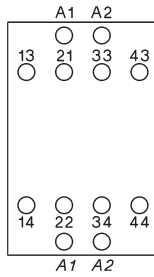

KG3-07A40
KG3-07D40

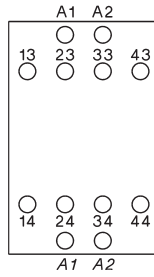

KG3-07A04
KG3-07D04

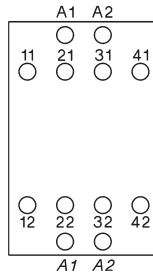

Contactors Relays

Dimensions

AC operated

K3-07ND..

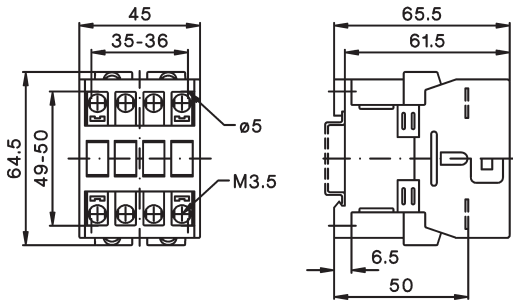

DC solenoid operated

KG3-07..

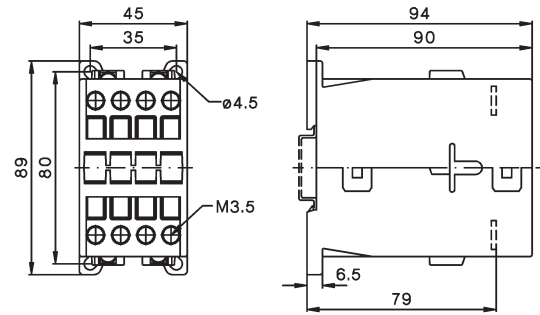

DC operated with double winding coil

K3-07ND.. =

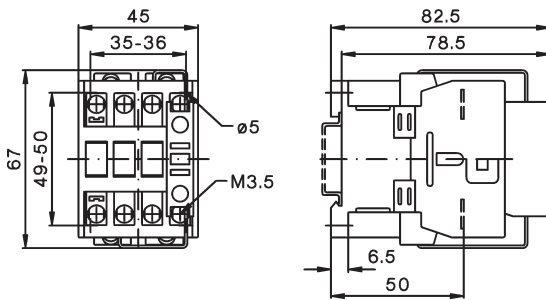





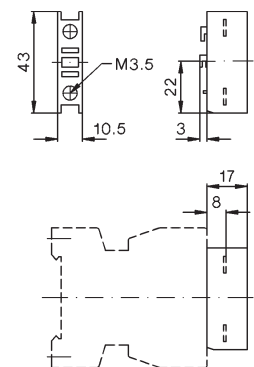



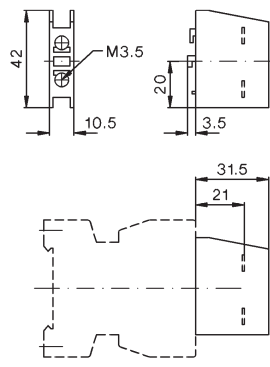

Auxiliary contact blocks

HN10, HN01

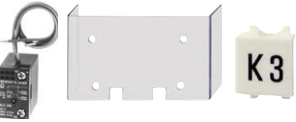

HA10, HA01



	Contactor overview	46
	Contactors 3-pole, AC Operated	48
	Contactors 3-pole, DC Operated	49
	Contactors 4-pole	50
	Capacitor Switching Contactors	51
	Auxiliary Contact Blocks Snap-on Momentary Contacts Additional Fourth Poles for Contactors	52
	Pneumatic Timers Electronic Timers On-delay Electronic Timers Off-delay	53
	Mechanical Interlocks Latches Additional Terminals, Parallel Connectors	54
	Indicator Units Fuse Holders Suppressor Units	55
	Interface Terminal Covers Mounting Parts	56
	Control Voltages	57
	Spare Coils AC-operated Feeder Groups	58
	Spare Coils DC-operated Spare Contacts	59
	Technical Data	62
	Dimensions	82

Contactors 3-pole

- Up to 1200A AC3
- Up to 1350A AC1
- DIN-rail mounting up to AC3 115A
- International Approvals
- Data according to IEC 947 / EN 60947



Ratings		10A	14A	18A	22A	24A	32A	40A	50A	62A	74A	90A	115A		
AC3 400V	Motor	4kW	5,5kW	7,5kW	11kW	11kW	15kW	18,5kW	22kW	30kW	37kW	45kW	55kW		
	380-400V 660-690V	5,5kW	7,5kW	10kW	10kW	15kW	18,5kW	18,5kW	30kW	37kW	45kW	55kW	55kW		
AC1	690V at 40°C	25A	25A	32A	32A	50A	65A	80A	110A	120A	130A	160A	200A		
Type	K3-	10ND10	14ND10	18ND10	22ND10	24A00	32A00	40A00	50A00	62A00	74A00	90A00	115A00		
Auxiliary contacts		1NO	1NO	1NO	1NO	-	-	-	-	-	-	-	-		
Type	K3-	10ND01	14ND01	18ND01	22ND01										
Auxiliary contacts		1NC	1NC	1NC	1NC										
Cable cross-section															
Solid	mm ²	0,75 - 6				1,5 - 25		4 - 50		10 - 120					
Flexible	mm ²	1 - 4				2,5 - 16		10 - 35		10 - 95					
Auxiliary contact															
I _{th} 40°C	A	10				-		-		-		-			
AC15 230V	A	3				-		-		-		-			
400V	A	2				-		-		-		-			
Power consumption															
Inrush VA		33 - 45				90 - 115		140 - 165		280					
of coils hold VA		7 - 10				9 - 13		13 - 18		5					
Operation range of coils		0,85 - 1,1				0,85 - 1,1		0,85 - 1,1		0,85 - 1,1					
Mounting		35mm DIN-rail or base										2x DIN-rail or base			
Additional aux. contact blocks															
Front mounting contacts	Type	HN10 1NO f. low level switching	HN01 1NC f. low level switching	HA10 1NO 25A I _{th}	HA01 1NC 25A I _{th}	max. 4 HN.. or 4 HA..		max. 7 HN.. or 7 HA..							
Additional aux. contact blocks															
Side mounting contacts	Type	-	-	-	-	HB11 1NO+1NC f. low level switching	HB02 2NC f. low level switching	max. 2 HB..							
Overload Relay (thermal)															
Single phase protection															
Temperature compensation															
Trip and alarm contacts															
Type		U3/32					U3/74					U85			
		U12/16..K3		U3/42											
Number of Setting Ranges from		16 0,12 - 30A		16 0,12 - 32A			4 10 - 42A					5 20 - 74A		2 60 - 120A	
Busbar sets		-													

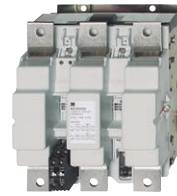

Contactor, Motor-Starter

Circuit Breakers

Manual Motor-Starters







Switches

AC-Main Switches

DC-Switch Disconnect







Push Buttons

Representatives, Suppliers

150A	175A	210A	260A	315A	450A	550A	700A	860A	1000A	1200A
75kW 90kW	90kW 110kW	110kW 160kW	132kW 210kW	160kW 250kW	250kW 375kW	300kW 475kW	400kW 630kW	500kW 700kW	580kW 850kW	680kW 1000kW
250A	300A	350A	450A	600A	700A	800A	1000A	1100A	1200A	1350A
151A00	176A00	210A00	260A00	316A00	450A22	550A22	700A22	860A22	1000A12	1200A12
-	-	-	-	-	2NO+2NC	2NO+2NC	2NO+2NC	2NO+2NC	1NO+2NC	1NO+2NC
2 x 16-120 2 x 16-120		busbar 30x6	busbar 30x6	busbar 30x6	busbar 30x5	busbar 40x6	busbar 50x8	busbar 50x8	busbar 50x10	busbar 50x10
- - -		- - -				10 3 2			10 3 2	
350 5 0,85 - 1,1	350 5	360 5	360 5 0,85 - 1,1	360 5	800-950 9-11	800-950 9-11	1350-1600 21-25 0,85 - 1,1	1350-1600 21-25	2400 70 0,85-1,1	2400 70
base										
	HKT11 HKT22 1NO+1NC 2NO+2NC max. 1 pc.					HKF22 2NO+2NC max. 1 pc.			HKB11 1NO+1NC max. 2 pcs.	
	HKA11 1NO+1NC max. 2 pcs.				-	-	-	-	-	-
										
U180	U320					U800				
1 120 - 180A integrated	2 144 - 320A integrated					3 240 - 800A SU840/550	SU840/860			

Contactors 3-pole

AC Operated

Ratings		Rated Current	Aux. Contacts		Type	Coil voltage ¹⁾	Pack pcs.	Weight kg/pc.	
AC2, AC3			Built-in	Additional see page 52					
380V									
400V	660V	AC1	NO	NC	Typ	24			
415V	690V	690V				110			
kW	kW	A				230			
						400			
	4	5,5	25	1	-	max. 4	K3-10ND10 ...	1	0,23
	4	5,5	25	-	1	HN.. or HA..	K3-10ND01 ...	1	0,23
	5,5	7,5	25	1	-		K3-14ND10 ...	1	0,23
	5,5	7,5	25	-	1		K3-14ND01 ...	1	0,23
	7,5	10	32	1	-		K3-18ND10 ...	1	0,23
	7,5	10	32	-	1		K3-18ND01 ...	1	0,23
	11	10	32	1	-		K3-22ND10 ...	1	0,23
	11	10	32	-	1		K3-22ND01 ...	1	0,23
	11	15	50	-	-	max. 4	K3-24A00 ...	1	0,48
	15	18,5	65	-	-	HN.. or HA..	K3-32A00 ...	1	0,48
	18,5	18,5	80	-	-	and 2HB..	K3-40A00 ...	1	0,48
	22	30	110	-	-	max. 4 (3) ⁴⁾	K3-50A00 ...	1	0,85
	30	37	120	-	-	HN.. or HA..	K3-62A00 ...	1	0,85
	37	45	130	-	-	and 2HB..	K3-74A00 ...	1	0,85
	45	55	160	-	-	max. 7	K3-90A00 ... ^{2) / VS ³⁾}	1	2,2
	55	55	200	-	-	HN.. or HA..	K3-115A00 ... ^{2) / VS ³⁾}	1	2,2
						and 2HB..			
	75	110	250	-	-	1 HKT..	K3-151A00 ... ²⁾	1	4
	90	132	300	-	-	and 2 HKA11	K3-176A00 ... ²⁾	1	4
	110	160	350	-	-		K3-210A00 ... ²⁾	1	7,2
	132	210	450	-	-		K3-260A00 ... ²⁾	1	7,2
	160	250	600	-	-		K3-316A00 ... ²⁾	1	7,2
	250	375	700	2	2	1 HKF22	K3-450A22 ... ²⁾	1	13
	300	475	800	2	2		K3-550A22 ... ²⁾	1	13,5
	400	630	1000	2	2		K3-700A22 ... ²⁾	1	26,5
	500	700	1100	2	2		K3-860A22 ... ²⁾	1	27,6
	580	850	1200	1	2	2 HKB11	K3-1000A12 ...	1	49
	680	1000	1350	1	2		K3-1200A12 ...	1	53

1) Coil voltage range and other coil voltages see page 57

2) Type for AC- and DC-operating: e.g.: 230: 220-240V 50/60Hz and 220V DC (with integrated coil suppressor)

3) Type 230VS for AC-operating 220-240V 50Hz (with integrated coil suppressor)

4) max. 3 HN.. or HA.. for DC-operated Contactors

DC Operated

Type	Coil voltage ¹⁾	Coil power	Additional Overload Relay	Wiring Diagram	Coil Circuits see page 53	Terminal Markings	Pack pcs.	Weight kg/pc.
	24	24V DC						
	48	48V DC						
	110	110V DC						
	220	110V DC						
	↓							



KG3-10A10 ... ⁵⁾		3/3	U3/32	1	0,53	
KG3-10A01 ... ⁵⁾		3/3	U12/16E U12/16EQ	1	0,53	
KG3-14A10 ... ⁵⁾		3/3	UAT21	1	0,53	
KG3-14A01 ... ⁵⁾		3/3		1	0,53	
KG3-18A10 ... ⁵⁾		3/3		1	0,53	
KG3-18A01 ... ⁵⁾		3/3		1	0,53	
KG3-22A10 ... ⁵⁾		3/3		1	0,53	
KG3-22A01 ... ⁵⁾		3/3		1	0,53	



KG3-24A00 ... ⁵⁾		4/4	U3/32	1	0,57	
KG3-32A00 ... ⁵⁾		4/4	U3/42	1	0,57	
KG3-40A00 ... ⁵⁾		4/4	UAT..	1	0,57	



K3-50A00= ...		200/6	U3/74	1	0,9	
K3-62A00= ...		200/6		1	0,9	
K3-74A00= ...		200/6		1	0,9	



K3-90A00 ... ²⁾		280/5	U85	1	2,2	
K3-115A00 ... ²⁾		280/5		1	2,3	



K3-151A00 ... ²⁾		350/5	U180	1	4	
K3-176A00 ... ²⁾		350/5		1	4	



K3-210A00 ... ²⁾		360/5	U320	1	7,2	
K3-260A00 ... ²⁾		360/5		1	7,2	
K3-316A00 ... ²⁾		360/5		1	7,2	



K3-450A22 ... ²⁾		800/10	U800	1	13	
K3-550A22 ... ²⁾		800/10	+SU840/550	1	13,5	

K3-700A22 ... ²⁾		1500/20	U800	1	26,5	
K3-860A22 ... ²⁾		1500/20	+SU840/860	1	27,6	

K3-1000A12= ...		2100/60		1	49	
K3-1200A12= ...		2100/60		1	53	

1) Other coil voltages on request

2) Type for AC- and DC-operating: e.g.: 24: 24V 50/60Hz and 24V DC (with integrated coil suppressor)

5) with integrated coil suppressor

Contactors 3-pole

DC Operated with double winding coil

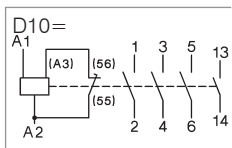
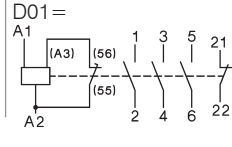
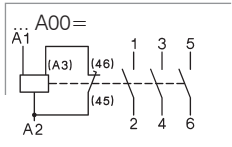
Ratings AC2 AC3 380V 400V 415V kW	Rated Current AC1 660V 690V kW	Aux. Contacts Built-in Additional see page 52 NO NC Type	Type	Coil voltage ¹⁾		Pack pcs.	Weight kg/pc.
				24 48 110 220	24V= DC 48V= DC 110V= DC 220V= DC		
4	5,5	25	1 - max. 3	K3-10ND10= ...	1	0,25	
4	5,5	25	- 1 HN..	K3-10ND01= ...	1	0,25	
5,5	7,5	25	1 - HA..	K3-14ND10= ...	1	0,25	
5,5	7,5	25	- 1	K3-14ND01= ...	1	0,25	
7,5	10	32	1 -	K3-18ND10= ...	1	0,25	
7,5	10	32	- 1	K3-18ND01= ...	1	0,25	
11	10	32	1 -	K3-22ND10= ...	1	0,25	
11	10	32	- 1	K3-22ND01= ...	1	0,25	
11	15	50	- - max. 4	K3-24A00= ...	1	0,55	
15	18,5	65	- - HN.. or	K3-32A00= ...	1	0,55	
18,5	18,5	80	- - HA.. + 2HB..	K3-40A00= ...	1	0,55	



Contactors 4-pole

AC or DC Operated

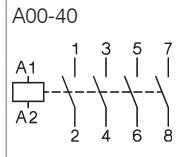
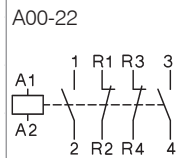
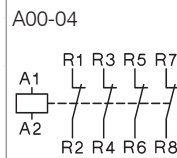
Ratings AC2 AC3 380V 400V 415V kW	Rated Current AC1 690V kW	Aux. Contacts Built-in Additional see page 52 NO NC Type	Type	Coil voltage ²⁾		Pack pcs.	Weight kg/pc.
				24 110 230 400 = 24	24V 50/60Hz 110V 50/60Hz 220-240V 50Hz 380-415V 50Hz 24V= DC ³⁾		
4	17,5	25	- - max. 4 ³⁾	K3-10NA00-40 ...³⁾	1	0,23	
4	17,5	25	- - HN.. or	K3-10NA00-22 ...³⁾	1	0,23	
4	17,5	25	- - HA..	K3-10NA00-04 ...³⁾	1	0,23	
5,5	17,5	25	- -	K3-14NA00-40 ...³⁾	1	0,23	
5,5	17,5	25	- -	K3-14NA00-22 ...³⁾	1	0,23	
5,5	17,5	25	- -	K3-14NA00-04 ...³⁾	1	0,23	
7,5	22	32	- -	K3-18NA00-40 ...³⁾	1	0,23	
7,5	22	32	- -	K3-18NA00-22 ...³⁾	1	0,23	
7,5	22	32	- -	K3-18NA00-04 ...³⁾	1	0,23	
11	22	32	- -	K3-22NA00-40 ...³⁾	1	0,23	
11	31	45	- - max. 4	K2-23A00-40 ...³⁾	1	0,65	
15	34,5	50	- - HN..	K2-30A00-40 ...³⁾	1	0,65	
18,5	34,5	50	- - or HA..	K2-37A00-40 ...³⁾	1	0,65	
22	55	80	- - max. 6	K2-45A00-40 ...³⁾	1	1,1	
30	69	100	- - HN.. or HA..	K2-60A00-40 ...³⁾	1	1,1	
15	43	63	- - 1HKT..	K3-41A00-04 ...⁴⁾	1	1,4	
15	43	63	- - +	K3-41A00-22 ...⁴⁾	1	1,4	
			2xHKA11				
30	85	125	- -	K3-96A00-04 ...⁴⁾	1	2,42	
30	85	125	- -	K3-96A00-22 ...⁴⁾	1	2,42	
45	94	135	- -	K3-96A00-40 ...⁴⁾	1	2,42	
55	139	200	- -	K3-116A00-40 ...⁴⁾	1	4,7	
75	173	250	- -	K3-151A00-40 ...⁴⁾	1	4,7	
90	208	300	- -	K3-176A00-40 ...⁴⁾	1	4,7	
110	242	350	- -	K3-210A00-40 ...⁴⁾	1	8	
132	310	450	- -	K3-260A00-40 ...⁴⁾	1	8	
160	415	600	- -	K3-316A00-40 ...⁴⁾	1	8	



Latch for Contactors 4-pole see page 54

1) Other coil voltages on request

2) Coil voltage range and non-standard coil voltages see page 57

4) with integrated coil suppressor (AC/DC coil)

Capacitor Switching Contactors

for use with reactive or non-reactive capacitor banks



Rated Operational Power at 50/60Hz

Ambient Temperature

50°C		60°C	
380V	415V	660V	380V
400V	440V	690V	400V
kVAr	kVAr	kVAr	kVAr

Aux. Contacts
Built-in Add.
NO NC pcs.

Type

Coil voltage ¹⁾
230 220-240V 50Hz
Pack Weight
pcs. kg/pc.

0-12,5	0-13	0-20	0-12,5	0-13	0-20	1	-	1 ²⁾	K3-18NK10 ...	1	0,34
0-12,5	0-13	0-20	0-12,5	0-13	0-20	-	-	1 ²⁾	K3-18NK01 ...	1	0,34
0-12,5	0-13	0-20	0-12,5	0-13	0-20	1	-	1 ²⁾	K3-18NBK10 ...	1	0,40
0-12,5	0-13	0-20	0-12,5	0-13	0-20	-	-	1 ²⁾	K3-18NBK01 ...	1	0,40
10-20	10,5-22	17-33	10-20	10,5-22	17-33	-	-	3 ³⁾	K3-24K00 ...	1	0,62
10-25	10,5-27	17-41	10-25	10,5-27	17-41	-	-	3 ³⁾	K3-32K00 ...	1	0,62
20-33,3	23-36	36-55	20-33,3	23-36	36-55	-	-	3 ³⁾	K3-50K00 ...	1	1,0
20-50	23-53	36-82	20-50	23-53	36-82	-	-	3 ³⁾	K3-62K00 ...	1	1,0
20-75 ⁴⁾	23-75 ⁴⁾	36-120 ⁴⁾	20-60	23-64	36-100	-	-	3 ³⁾	K3-74K00 ...	1	1,0
33-80	36-82	57-120	33-75	36-77	57-120	-	-	6 ⁵⁾	K3-90K00 ... / VS ⁷⁾	1	2,3
33-100 ⁶⁾	36-103 ⁶⁾	57-148 ⁶⁾	33-90 ⁶⁾	36-93 ⁶⁾	57-148 ⁶⁾	-	-	6 ⁵⁾	K3-115K00 ... / VS ⁷⁾	1	2,3

Specification: Contactors K3-..K are suitable for switching low-inductive and low loss capacitors in capacitor banks (IEC70 and 831, VDE 0560) without and with reactors.

Capacitor switching contactors are fitted with early make contacts and damping resistors, to reduce the value of make current <70 x I_e.

Operating Conditions: Capacitor switching contactors are protected against contact welding for a prospective making current of 200 x I_e.

Technical Data acc. to IEC 947-4-1, IEC 947-5-1, EN 60947-4-1, EN 60947-5-1, VDE 0660

Type		K3-18NK	K3-18NBK ⁸⁾	K3-24K	K3-32K	K3-50K	K3-62K	K3-74K	K3-90K	K3-115K
Max. frequency of operations z	1/h	120	120	120	120	120	120	80	80	80
Contact life non reactive cap. banks S x 10 ³		250	250	150	150	150	150	120	120	120
	reactive cap. banks S x 10 ³	400	400	300	300	300	300	200	200	200
Rated operational current I_e AC6b	at 50°C A	0-18	0-18	14-28	14-36	30-48	30-72	30-108	50-115	50-144
	at 60°C A	0-18	0-18	14-28	14-36	30-48	30-72	30-87	50-108	50-130
Rated operational current I _{th} AC1	at 50°C A	32	45	45	60	100	110	120	155	190
	at 60°C A	32	40	40	55	90	100	110	145	170
Overload factor acc. to EN 61921: 30% min.	at 50°C %	78	150	60	67	108	53	11	35	32
	at 60°C %	78	122	43	53	88	39	26	34	31
Fuses gL (gG)	from / to A	35 / 63	35 / 63	50 / 80	63 / 100	80 / 160	125 / 160	160/200	160/200	160/250

Typical Circuit Diagram

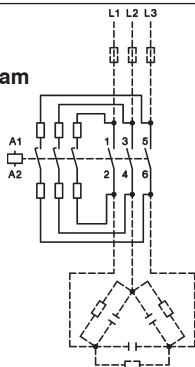

Wiring Diagram for Quick Discharge Resistors

Make sure that the current of the discharge resistors is not higher than the rated current (AC1) of the auxiliary contacts

Mounting instructions:

In the area of capacitor switching contactors, difficulty inflammable and self-extinguishing materials shall be used only, because abnormal temperatures within the area of the resistor spirals cannot be excluded.

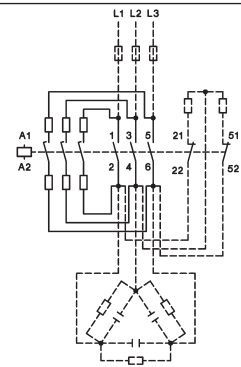

- 1) Coil voltage range and non-standard coil voltages see page 57
- 2) 1 HN.. or HA.. snap-on
- 3) 2HB.. for side mounting and 1 HN.. or HA.. snap-on
- 4) Consider the max. thermal current of the contactor K3-74A: I_{th} 130A
- 5) 2 HB.. on the left or right side and 4 HN.. or HA.. snap-on
- 6) Consider the min. cross-section of conductor at max. load
- 7) Type 230 for AC- and DC-operating 220-240V 50/60Hz and 220V DC (with integrated coil suppressor)
Type 230VS for AC-operating 220-240V 50Hz (with integrated coil suppressor)
- 8) Cable cross sections: 2,5 - 16mm²

Auxiliary Contact Blocks for contactors K(G)3-07.. to K3-115.., type HN.. for low level switching ¹⁾



Rated Operational Current			Contacts				Type	Pack pcs.	Weight kg/pc.
AC15 230V A	AC15 400V A	AC1 690V A	NO	NC	EM	LB			
3	2	10	1	-	-	-	HN10	10	0,02
3	2	10	-	1	-	-	HN01	10	0,02
3	2	10	-	-	1	-	HN10U	10	0,02
3	2	10	-	-	-	1	HN01U	10	0,02
6	3	25	1	-	-	-	HA10	10	0,03
6	3	25	-	1	-	-	HA01	10	0,03

Auxiliary Contact Block for contactors K3-24.. to K3-115.., for low level switching ¹⁾



Rated Operational Current			mounting: 1 HB.. on left side and 1 HB.. on right side	Contacts		Type	Pack pcs.	Weight kg/pc.
AC15 230V A	AC15 400V A	AC1 690V A		NO	NC			
3	2	10		1	1	HB11	10	0,02
3	2	10		-	2	HB02	10	0,02

Auxiliary Contact Blocks for contactors K3-116.. to K3-1200.., for low level switching ¹⁾



Rated Operational Current			For contactors	Contacts		Type	Pack pcs.	Weight kg/pc.
AC15 230V A	AC15 400V A	AC1 690V A		NO	NC			
3	2	10	K3-116 to K3-316 top	1	1	HKT11	1	0,04
3	2	10	K3-116 to K3-316 top	2	2	HKT22	1	0,05
3	2	10	K3-116 to K3-316 outside	1	1	HKA11	1	0,05
6	3	16	K3-200 to K3-860 ²⁾	2 ²⁾	2	HKF22	1	0,12
6	3	16	K3-1000, K3-1200 inside	1	1	HKB11	1	0,17

Snap-on Momentary Contacts for K(G)3-07.. to K3-115.. for low level switching ¹⁾



Rated Operational Current			Specification	Contacts		Type	Pack pcs.	Weight kg/pc.
AC15 230V A	AC15 400V A	AC1 690V A		NO	NC			
3	2	10	manual operated	1	-	HTN10	10	0,02
3	2	10	manual operated	-	1	HTN01	10	0,02

Terminal Blocks for contactors K(G)3-07.. to K3-115.. and K2-..



Specification	Thermal Current I _{th} A	Type	Pack pcs.	Weight kg/pc.
2 terminals interconnected	26	K2-DK	10	0,02
2 terminals insulated	26	K2-SK	10	0,02

1) Contacts suitable for electronic circuits, according to IEC60947-5-4 for rated voltage 24V DC (test ratings 17V DC, 5mA) Mirror contacts acc. IEC60947-4-1 Annex F. Technical data see page 80

2) Contact travel of make contacts adjustable, see page 81

Electronic Timer

for mounting on DIN-rail, Control voltage 24-240V AC/DC, 1 changeover contact
 OFF-delay without auxiliary voltage
 Replace Pneumatic Timer K2-TP. and K2-TA



5 Functions in one device	4 Time ranges in one device s	Rated Current AC1 250V A	Type	Pack pcs.	Weight kg/pc.
ON-delay, OFF-delay, Single shot trailing edge, Single shot leading edge, Single shot leading and trailing edge	0,1 - 1, 1 - 10, 6 - 60 a. 18 - 180	5	K3-T180 240	1	0,085

Electronic Timer On-delay for contactors K(G)3-07.. to K3-115.. and K2-..

Timer will be connected with the contactor coil, can be snapped onto the contactor and occupies 2 add-on spaces. Contactor switches On-delay.



Operational Voltage V	Time Range s	Rated Current AC15 A	Type	Pack pcs.	Weight kg/pc.
24 - 60V AC/DC	1 - 30	0,75	K2-TE30 60	1	0,08
100 - 250V AC/DC	1 - 30	0,75	K2-TE30 250	1	0,08
24 - 60V AC/DC	10 - 180	0,75	K2-TE180 60	1	0,08
100 - 250V AC/DC	10 - 180	0,75	K2-TE180 250	1	0,08
24 - 60V AC/DC	30 - 600	0,75	K2-TE600 60	1	0,08
100 - 250V AC/DC	30 - 600	0,75	K2-TE600 250	1	0,08

Wiring Diagram

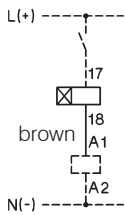

Timing Chart

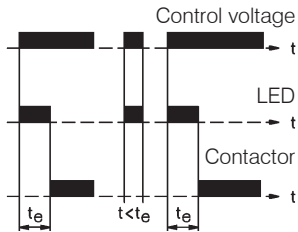

Operation Range

Time repeat accuracy
 Recovery time (typical)

$0,8 - 1,1 \times U_s$
 $\leq 1\%$
 50ms

Voltage Drop after the time delay t_e
 (Control voltage 24V: use contactor with 20V-coil)
 Max. inrush current (peak value)

<3V
 25A <10ms

Duty Cycle

Ambient temperature
 Short circuit protection

100%
 $-40^\circ - +60^\circ\text{C}$
 2A

Interface for contactors K3-07.. to K3-74.. and K2-07.. to K2-60..



Input Voltage U_e	Power Consumption	Rated Current I_e AC15	250V AC	400V AC	Type	Pack pcs.	Weight kg/pc.
24V DC	0,35W	0,75A	0,5A		K2-IM	1	0,03

Amplifier element for contactor control by programmable controller

Fuse Holders for contactors K(G)3-07.. to K3-115.. and K2-..



Specifications	Rated Voltage	Type	Pack pcs.	Weight kg/pc.
Fuse holder for fuse 5x20mm (max. 6,3A) Fuses are not included.	250V AC	K2-F	1	0,02

Rectifier with Fuse Holder for contactors K(G)3-07.. to K3-115.. and K2-..

Specifications	Rated Voltage	Type	Pack pcs.	Weight kg/pc.
with built-in rectifier 1A	250V AC	K2-RF1	1	0,03
with built-in rectifier 3A	250V AC	K2-RF3	1	0,03

Latch for contactors K(G)3-07.. to K3-74.. and K2-..

with NC aux. contact
power consumption max. 30VA

Type	Coil voltage
24	22-26V 50/60Hz
110	100-120V 50/60Hz
230	210 -250V 50/60Hz
400	360-440V 50/60Hz

For Contactors

For Contactors	Type	Pack pcs.	Weight kg/pc.
K3-07 to K3-22, K2-07 to K2-16	K2-L22 . . .	1	0,08
K3-24 to K3-40, K2-23 to K2-37, KG3-10 to KG3-40	K2-L40 . . .	1	0,08
K3-50 to K3-74, K2-45 to K2-60	K2-L74 . . .	1	0,08

Technical data see page 74

Latch / Magnetic latch for Contactors K3-151 to K3-1200 on request

Indicator Units for contactors K(G)3-07.. to K3-115.. and K2-..



Specifications	Voltage Range	Type	Pack pcs.	Weight kg/pc.
Coil Current Indicator , green (LED)	24 - 660V AC/DC	K2-ING	10	0,02
Coil Current Indicator , red (LED)	24 - 660V AC/DC	K2-INR	10	0,02
To connect in series with the contactor coil. In case of coil interruption the indication goes out. Voltage drop appr. 2 volts				
Voltage Indicator , clear (glow-disc. I.)	220 - 415V AC/DC	K2-UN	10	0,02
Voltage Indicator , red (LED)	24 - 120V AC/DC	K2-UNR	10	0,02
To connect parallel to the contactor coil. In case of applied voltage the indication also lights at coil interruption.				

Snap-On Adapter



For Type	Specification	Type	Pack pcs.	Weight kg/pc.
K2-DK, K2-SK, K2-TE, K2-TA K2-IM, K2-F, K2-RF K2-IN., K2-UN.	for snap-on mounting of accessories on 35mm DIN-rail acc. DIN EN 50022	K2-SM	10	0,009

Additional 4th Poles for contactors K3-315.. to K3-1200



For Contactors	Thermal Current I_{th} A	Type	Pack pcs.	Weight kg/pc.
K3-315, K3-450, K3-550	325	NP325	1	0,7
K3-315, K3-450, K3-550	500	NP500	1	1,3
K3-450, K3-550	760	NP760	1	1,4
K3-700, K3-860	500	NP501	1	1,3
K3-700, K3-860	1000	NP1000	1	1,6
K3-1000, K3-1200	1000	NP1001	1	1,6

Mechanical Interlocks



Interlocks contactor with contactor Type	Type	Mounting	Type	Pack pcs.	Weight kg/pc.
K3-07 to K3-40 KG3-07 to KG3-22 KG3-24 to KG3-40 K2-07 to K2-37	K3-07 to K3-40 KG3-07 to KG3-22 KG3-24 to KG3-40 K2-07 to K2-37	horizontal	LG10889 ¹⁾	10	0,006
K3-24 to K3-74 K2-23 to K2-60	K3-50 to K3-74 K2-45 to K2-60	horizontal	LG10890 ¹⁾	1	0,010
K3-90, K3-115	K3-90, K3-115	horizontal	LG11478 ¹⁾	1	0,010
K65 to K110	K65 to K110	horizontal	LG8511	1	0,076
K3-116 to K3-316	K3-116 to K3-316	horizontal	LG11223H	1	0,06
K3-315 to K3-550 K3-315 to K3-550	K3-315 to K3-550 K3-315 to K3-550	horizontal vertical	LG10400H LG10400V	1 1	0,8 0,8
K3-450, K3-550 K3-450, K3-550	K3-700, K3-860 K3-700, K3-860	horizontal vertical	LG10399H LG10399V	1 1	1,6 0,9
K3-700, K3-860 K3-700, K3-860	K3-700, K3-860 K3-700, K3-860	horizontal vertical	LG10402H LG10402V	1 1	1,5 0,9
K3-700, K3-860 K3-700, K3-860	K3-1000, K3-1200 K3-1000, K3-1200	horizontal vertical	LG10401H LG10401V	1 1	1,9 1,6
K3-1000, K3-1200 K3-1000, K3-1200	K3-1000, K3-1200 K3-1000, K3-1200	horizontal vertical	LG10403H LG10403V	1 1	1,8 1,5

1) clamps for mounting incl.

Terminal Covers for terminal protection according to DIN 57106, VBG 4



For Contactors	Specification	Type	Pack pcs.	Weight kg/pc.
K65 to K110 (spare part)	for 6 terminals	LG9333	1	0,045
K3-151, K3-176 3-pole	for 3 terminals	LG10404	1	0,12
K3-116 to K3-176 4-pole	for 4 terminals	LG104044	1	0,14
K3-210, K3-260, K3-316	for 3 terminals	LG11457	1	0,14
K3-200	for 3 terminals	LG10405	1	0,18
K3-315, K3-450	for 3 terminals	LG10406	1	0,28
K3-550	for 3 terminals	LG10407	1	0,34
K3-700	for 3 terminals	LG10408	1	0,39
K3-860	for 3 terminals	LG10409	1	0,49

Additional Terminals



For Contactors	Cable Cross-sections to clamp mm ² solid or stranded	flexible	flex. with multi- core cable end	Type	Pack pcs.	Weight kg/pc.
Additional Terminal Single Pole, with fingertouch protection						
K(G)3-10 to K(G)3-22 K2-09 to K2-16	0,75 - 10	0,75 - 6	0,75 - 6	LG9339N	6	0,009
K3-151 to K3-176	16 - 120 + 16 - 95			LG11224	1	0,10

Parallel Connectors



For Contactors	Cable Cross-sections to clamp mm ² solid or stranded	flexible	flex. with multi- core cable end	Type	Pack pcs.	Weight kg/pc.
----------------	---	----------	-------------------------------------	------	--------------	------------------

Parallel Connectors, 3 Poles Parallel

Current-carrying capacity: 2,5 x AC1-value of the contactor

K(G)3-10 to K(G)3-22	terminal hole for screw M5			LG9241	50	0,004
K2-09 to K2-16						
K2-23 to K2-37	4 - 35	6 - 25	4 - 25	LG5587	10	0,022

Parallel Connectors, 4 Poles Parallel

Current-carrying capacity: 3,2 x AC1-value of the contactor

K(G)3-10 to K(G)3-22	terminal hole for screw M5			LG7360	10	0,006
K2-09 to K2-16						

Suppressor Units



Voltage Range V	Mounting	Type	Pack pcs.	Weight kg/pc.
--------------------	----------	------	--------------	------------------

RC-units for contactors K3-07 - K3-74

12 - 48V AC/DC	to snap	1600nF / 22 Ohm	RC-K3N 24	10	0,01
48 - 127V AC/DC	on the	680nF / 270 Ohm	RC-K3N 110	10	0,01
110 - 230V AC/DC	contactor	220nF / 2200 Ohm	RC-K3N 230	10	0,01
230 - 415V AC/DC		120nF / 620 Ohm	RC-K3N 400	10	0,01

RC-units for contactors K3-07 - K3-74 and reversing contactors K3NWU10 - K3WU74

12 - 48V AC/DC	to snap	1600nF / 22 Ohm	RC-K3NW 24	10	0,01
48 - 127V AC/DC	on the	680nF / 270 Ohm	RC-K3NW 110	10	0,01
110 - 230V AC/DC	contactor	220nF / 2200 Ohm	RC-K3NW 230	10	0,01
230 - 415V AC/DC		120nF / 620 Ohm	RC-K3NW 400	10	0,01

Mounting Parts



Description	For Type	Specification	Type	Pack pcs.	Weight kg/pc.
-------------	----------	---------------	------	--------------	------------------

Clamp, no distance	K3-07 to K3-115 K2-07 to K2-37	To join contactors without distance, 2 pieces required	P426-1	50	0,001
-------------------------------	-----------------------------------	--	---------------	----	-------



Clamp, 7mm distance	K3-07 to K3-115 K2-07 to K2-37	To join contactors with 7mm distance, 2 pieces required	P418-1	10	0,002
--------------------------------	-----------------------------------	---	---------------	----	-------

Clamp, 12mm distance	K3-07 to K3-115 K2-07 to K2-37	To join contactors with 12mm distance, 2 pieces required	P807-1	10	0,002
---------------------------------	-----------------------------------	--	---------------	----	-------

Clamp asymmetric	K3-07 to K3-40 with K3-50 to K3-74	To join contactors with 12mm distance, 2 pieces required	P785-1	10	0,002
-----------------------------	---------------------------------------	--	---------------	----	-------



Retention clamp	K3-10 to K3-74	To close contactors	P725		
------------------------	----------------	---------------------	-------------	--	--

Marking System for contactors K3-07.. to K3-115.., K2-.. and aux. contact blocks HN and HA



Description	Specification	Type	Pack pcs.	Weight kg/100pc
-------------	---------------	------	--------------	--------------------

Marking Plate	2-section without marking, divisible	P487-1	100	0,025
----------------------	--------------------------------------	---------------	-----	-------

Marking Plate	3-section without marking, divisible	P971-1	100	0,038
----------------------	--------------------------------------	---------------	-----	-------

Marking Plate	4-section without marking, divisible	P245-1	100	0,050
----------------------	--------------------------------------	---------------	-----	-------

Marking Plate	marked, choice of K1...K32	P245-K..	100	0,013
----------------------	----------------------------	-----------------	-----	-------

**Type-suffix for coil-types K6/.. to K45/...
for contactor-types K3-07.. to K3-74**

Suffix to contactor type	to coil type	Voltage Marking		Rated Control Voltage U _s			
		at the coil		range		for 60Hz	
		for 50Hz V	for 60Hz V	for 50Hz min. V	max. V	min. V	max. V
6	41.6	6		6	6,6	6,6	7,3
6,6	41.6,6	6,6		6,6	7,3	7,3	8
7,3	41.7,3	7,3		7,3	8	8	9
8	41.8	8		8	9	9	10
9	41.9	9		9	10	10	11
10	41.10	10		10	11	11	12
11	41.11	11	12	11	12	12	13,2
12	41.12	12		12	13,2	13,2	14,5
13,2	41.13	13,2		13,2	14,5	14,5	16
14,5	41.14	14,5		14,5	16	16	18
16	41.16	16		16	18	18	20
18	41.18	18		18	20	20	22
20	41.20	20		20	22	22	24
24	4.24	24	24	22	24	24	27
25	41.25	25		24	27	27	30
27	41.27	27	32	27	30	30	33
32	41.32	32	36	30	33	33	36
33	41.33	36	36	33	36	36	39
36	41.36	36	42	36	39	39	42
40	41.40	42	42	39	42	42	47
42	4.42	42	48	42	47	47	52
48	41.48	48	48	44	48	48	52
55	41.55	55	60	52	58	58	65
60	41.60	60		58	65	65	72
65	41.65	65		65	72	72	80
75	41.75	75		72	80	80	90
85	41.85	85		80	90	90	100
90	41.90	100	100	90	100	100	110
110	4.110	110	110-120	100	110	110	122
115	41.115	115	125	110	122	122	135
127	41.127	127		122	135	135	150
140	41.140	140		135	150	150	165
150	41.150	150		150	165	165	180
165	41.165	165	180-208	165	180	180	208
180	41.180	180-210 ¹⁾	200-240 ¹⁾	180	210 ¹⁾	200	240 ¹⁾
190R ²⁾	41.190	200-240	200-240	200	240	200	240
200	41.200	200-230 ¹⁾	220-240	200	230 ¹⁾	220	240
230	4.230	220-240	230-264	220	240	230	264
254	41.254	254	277	240	264	264	290
270	41.270	270		264	290	290	315
300	41.300	300		290	315	315	345
320	41.320	320		315	345	345	380
345	41.345	345-400 ¹⁾	380-440 ¹⁾	345	400 ¹⁾	380	440 ¹⁾
390R ²⁾	41.390	400-480	400-480	400	480	400	480
400	4.400	380-415	400-440	380	415	400	460
415	41.415	415-440	440-480	400	440	440	480
440	41.440	440-480	480-500	440	480	480	530
480	41.480	480-500	530-580	480	530	530	580
500	41.500	500-550	550-600	500	550	550	600
550	41.550	550-600	600	550	600	600	(650)

Standard voltages in bold type letters

- 1) Operating range of magnet-coils: 0,85 x U_s (min. value of rated control voltage) up to 1,05 x U_s (max. value of rated control voltage)
- 2) Reduction of mechanical life to 10% of normal life. It is not admissible as a spare coil in a contactor for different coil voltages.

**Type-suffix for coil-types K85/... and K110/...
for contactor-types K85 to K110**

Suffix to contactor type	to coil type	Voltage Marking		Rated Control Voltage U _s			
		at the coil		range		for 60Hz	
		for 50Hz V	for 60Hz V	for 50Hz min. V	max. V	min. V	max. V
20	4.20	20	24	20	22	24	26
24	4.24	24		24	27	29	32
42	4.42	42		42	47	50	56
110	4.110	110-120		110	122	132	146
230	4.230	220-240	277	220	240	264	288
400	4.400	380-415	460-480	380	415	455	498

**Type-suffix for coil-types K3-1200/...
for contactor-types K3-1000.. to K3-1200..**

110	4.110	110-115	-	110	115	110	115
230	4.230	220-230	-	220	230	220	230
400	4.400	380-400	-	380	400	380	400
440	4.440	440	-	440	440	440	440

Coil voltages for AC and DC operated contactors

**Type-suffix for coil-types K3-115/.. to K3-860/...
for contactor-types K3-90.. to K3-860..**

Suffix to contactor type	to coil type	Voltage Marking		Rated Control Voltage U _s			
		at the coil		range		for 60Hz	
		for 50/60Hz V	for DC V	for 50Hz min. V	max. V	min. V	max. V
24	4.24	24	24	22	24	22	24
48	4.48	48	48	44	48	44	48
110	4.110	110-120	110	110	120	110	120
230	4.230	220-240	220	220	240	220	240
400	4.400	380-415	-	380	415	380	415

Coil voltages for AC operated contactors

**Type-suffix for coil-types K3-115/..AC
for contactor-types K3-90..AC to K3-115..AC**

Suffix to contactor type	to coil type	Voltage Marking		Rated Control Voltage U _s			
		at the coil		range		for 60Hz	
		for 50Hz V	for 60Hz V	for 50Hz min. V	max. V	min. V	max. V
110AC	4.110AC	110-122	132-146	110	122	132	146
230AC	4.230AC	220-240	277	220	240	264	288

Other coil voltages on request

Operating range of magnet-coils: 0,85 x U_s (min. value of rated control voltage) up to 1,1 x U_s (max. value of rated control voltage)

With reduced control voltage range 0,9 up to 1,0 x U_s at ambient temperature 60 - 90°C

Spare Coils for AC operated contactors



		Type	Coil voltage ¹⁾	Pack pcs.	Weight kg/pc.
For Contactors		4.24	24V 50Hz		
		4.42	42V 50Hz		
		4.110	110V 50Hz		
		41.180	180V 50Hz, 220V 60Hz		
		4.230	220-240V 50Hz		
		4.400	380-415V 50Hz		
		↓			
K3-07N.. up to K3-22N..		K10N/ .. .EUR		1	0,053
K3-07.. up to K3-22..		K3-6/ ...		10	0,040
K2-07.. up to K2-16..		K6/ ...		10	0,040
K3-24.. up to K3-40..		K24/ ...		1	0,085
K2-23.. up to K2-37..		K23/ ...		1	0,085
K3-50.. up to K3-74.., K2-45.., K2-60..		K45/ ...		1	0,110
K65.., K85..		K85/ ...		1	0,215
K110..		K110/ ...		1	0,220
For Contactors		Type	Coil voltage ¹⁾	pcs.	kg/pc.
		4.110	110V 50Hz, 110-115V 60Hz		
		4.230	220-230V 50Hz		
		4.400	380-400V 50Hz		
		↓			
K3-150.., K3-175..		K3-175/ ...		1	0,38
K3-1000.., K3-1200..	without feeder group ²⁾	K3-1200/ ...		1	3,12

Spare Coils for AC and DC operated contactors



		Type	Coil voltage ¹⁾	Pack pcs.	Weight kg/pc.
For Contactors		4.24	24V 50/60Hz / 24V DC		
		4.110	110-120V 50/60Hz / 110V DC		
		4.230	220-240V 50/60Hz / 220V DC		
		4.400	380-415V 50/60Hz		
		↓			
K3-90.., K3-115..	with feeder group	K3-115/ ...		1	0,30
K3-151.., K3-176..	with feeder group	K3-176/ ...		1	0,68
K3-210.., K3-316..	with feeder group	K3-316/ ...		1	0,68
K3-450.., K3-550..	without feeder group ²⁾	K3-550/ ...		1	1,63
K3-700.., K3-860..	without feeder group ²⁾	K3-860/ ...		1	2,44

Spare Feeder Groups for contactors K3-450.. to K3-860..

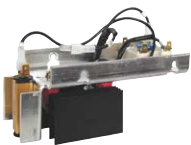

		Type	Coil voltage ¹⁾	Pack pcs.	Weight kg/pc.
In case of changing control voltage, change coil and feeder group too		110	110-120V 50/60Hz / 110V DC		
		230	220-240V 50/60Hz / 220V DC		
		400	380-415V 50/60Hz		
		↓			
K3-450.., K3-550..	K3-550/4...	K3-550/FG ...		1	0,33
K3-700.., K3-860..	K3-860/4..	K3-860/FG ...		1	0,54

1) Coil voltage range and non-standard coil voltages see page 57

2) In case of changing control voltage, change coil and feeder group too

Spare Coils for DC operated contactors

Contactors, Motor-Starter
 Circuit Breakers
 Manual Motor-Starters
 Switches
 AC-Main Switches
 DC-Switch Disconnecter
 Push Buttons
 Representatives, Suppliers



		Aux. Contact Block for double winding coil	Type	Coil voltage ¹⁾	Pack pcs.	Weight kg/pc.
For Contactors			47.24 47.48 47.110 47.220	24V DC 48V DC 110V DC 220V DC		
K3-07N..= up to K3-22N..=	HN01U	K10N/ ...	1	0,052		
K3-07..= up to K3-22..=	HN01U	K3-6/ ...	1	0,042		
K2-07..= up to K2-16..=	HN01U	K6/ ...	1	0,042		
K3-24..= up to K3-40..=	HN01X	K24/ ...	1	0,090		
K2-23..= up to K2-37..=	HN01X	K23/ ...	1	0,090		
K3-50..= up to K3-74..=, K2-45..=, K2-60..=	HN01Z	K45/ ...	1	0,115		
K65..=, K85..=	-	K85/ ...	1	0,220		
K110..=	-	K110/ ...	1	0,225		
For Contactors			43.110 43.220	110V DC 220V DC		
K3-1000..=, K3-1200..=	without feeder group ²⁾	K3-1200/ ...	1	3,12		

Wiring Diagrams for Coil Circuit

AC operated,

K3-07..
up to **K110..**



DC operated
with double winding coil

K3-07..=
up to **K3-22..=**

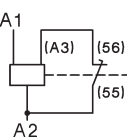

DC operated

KG3..

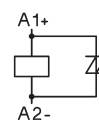

AC and DC operated
with double winding coil
K3-90A00, K3-115A00
K3-151A00, K3-176A00
K3-210A00 to K3-316A00

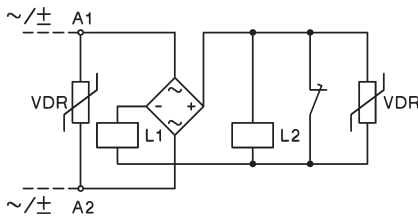

K3-24..=
to
K3-74..=

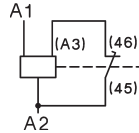

AC and DC operated
with series resistor
K3-200A21
K3-315A21

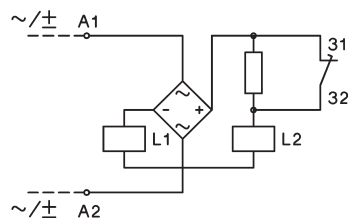

K85..=
K110..=

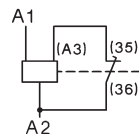

AC and DC operated
with series resistor
K3-450.. up to **K3-860..**

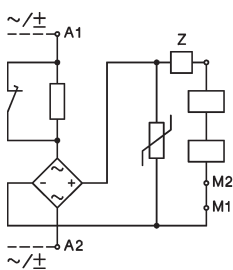

DC operated
with DC coil
K3-1000.., K3-1200..

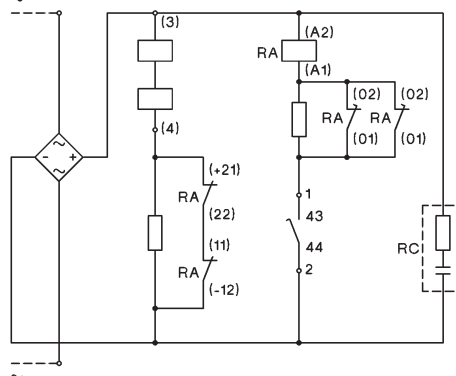

AC operated
with DC coil
K3-1000.., K3-1200..

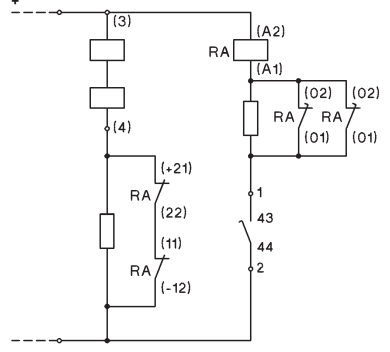

Adjustable dropout operating time for K3-450.. to K3-860..
 150-200ms: Wiring see above (delivery standard)
 500-1000ms: Jumper device "Z"
 approx. 20ms: Special wiring see package folder

Contactors K3-1000.., K3-1200..
 For control voltages up to 125V
 NC contacts 21-22 and 11-12 are connected parallel,
 for higher voltages contacts are connected in series (delivery standard).

1) Other coil voltages on request
 2) In case of changing control voltage, change coil and feeder group too

Spare Contacts

Main Contacts for Contactors	Type	Pack pcs.	Weight kg/pc.
K85..	EK85/1	3	0,235
K110..	EK110/1	3	0,275
K3-150..	EK3-150/10	1	0,32
K3-151..	EK3-151/10	1	0,16
K3-175..	EK3-175/10	1	0,32
K3-176..	EK3-176/10	1	0,16
K3-200..	EK3-200/10	1	0,18
K3-210..	EK3-210/10	1	0,18
K3-260..	EK3-260/10	1	0,30
K3-315..	EK3-315/10	1	0,34
K3-316..	EK3-316/10	1	0,34
K3-450..	EK3-450/10	1	0,35
K3-550..	EK3-550/10	1	0,35
K3-700..	EK3-700/10	1	0,85
K3-860..	EK3-860/10	1	1,0
K3-1000..	EK3-1000/10	1	1,4
K3-1200..	EK3-1200/10	1	1,4

Contactors

Data according to IEC 947-4-1, EN 60947-4-1, VDE 0660

Main Contacts	Type	K(G)3-10	K(G)3-14	K(G)3-18	K(G)3-22	K(G)3-24	K(G)3-32	K(G)3-40	K3-50	K3-62	K3-74
Rated insulation voltage U_i ¹⁾	V AC	690	690	690	690	690	690	690	830	830	830
Making capacity I_{eff} at $U_e = 690V$ AC	A	200	200	200	200	400	500	500	700	900	900
	1000V AC	-	-	-	-	-	-	-	-	-	-
Breaking capacity I_{eff} 400V AC	A	180	180	200	200	380	400	400	600	800	800
K3-10 to K3-22 $\cos\phi = 0,65$	A	150	150	180	180	300	370	370	500	700	700
K3-24 to K3-1200 $\cos\phi = 0,35$	A	100	100	150	150	260	340	340	400	500	500
	1000V AC	-	-	-	-	-	-	-	-	-	-
Utilization category AC1											
Switching of resistive load											
Rated operational current $I_e (=I_{th})$ at 40°C, open	690V A	25	25	32	32	50	65	80	110	120	130
Rated operational power of three-phase resistive loads 50-60Hz, $\cos\phi = 1$	220V kW	9,5	9,5	12,2	12,2	19,0	24,7	30,4	41,9	45,7	49,5
	230V kW	9,9	9,9	12,7	12,7	19,9	25,9	31,8	43,8	47,7	51,7
	240V kW	10,4	10,4	13,3	13,3	20,8	27,0	33,2	45,7	49,8	54,0
	380V kW	16,4	16,4	21,0	21,0	32,9	42,7	52,6	72,3	78,9	85,5
	400V kW	17,3	17,3	22,1	22,1	34,6	45,0	55,4	76,1	83,0	90,0
	415V kW	17,9	17,9	23,0	23,0	35,9	46,7	57,4	79,0	86,2	93,3
	440V kW	19,0	19,0	24,4	24,4	38,1	49,5	60,9	83,7	91,3	99,0
	500V kW	21,6	21,6	27,7	27,7	43,3	56,2	69,2	95,2	103,8	112,5
	660V kW	28,5	28,5	36,5	36,5	57,1	74,2	91,3	125,6	137,0	148,4
	690V kW	29,8	29,8	38,2	38,2	59,7	77,6	95,5	131,3	143,2	155,2
	1000V kW	-	-	-	-	-	-	-	-	-	-
Rated operational current $I_e (=I_{th})$ at 60°C, enclosed	690V A	25	25	32	32	40	55	65	90	100	110
Rated operational power of three-phase resistive loads 50-60Hz, $\cos\phi = 1$	220V kW	9,5	9,5	12,2	12,2	15,2	20,9	24,7	34,3	38,1	41,9
	230V kW	9,9	9,9	12,7	12,7	15,9	21,9	25,9	35,8	39,8	43,8
	240V kW	10,4	10,4	13,3	13,3	16,6	22,8	27,0	37,4	41,5	45,7
	380V kW	16,4	16,4	21,0	21,0	26,3	36,2	42,7	59,2	65,7	72,3
	400V kW	17,3	17,3	22,1	22,1	27,7	38,1	45,0	62,3	69,2	76,1
	415V kW	17,9	17,9	23,0	23,0	28,7	39,5	46,7	64,6	71,8	79,0
	440V kW	19,0	19,0	24,4	24,4	30,4	41,9	49,5	68,5	76,1	83,7
	500V kW	21,6	21,6	27,7	27,7	34,6	47,6	56,2	77,9	86,5	95,2
	660V kW	28,5	28,5	36,5	36,5	45,7	62,8	74,2	102,8	114,2	125,6
	690V kW	29,8	29,8	38,2	38,2	47,7	65,7	77,6	107,4	119,4	131,3
	1000V kW	-	-	-	-	-	-	-	-	-	-
Minimum cross-section of conductor at load with $I_e (=I_{th})$	mm ²	4	4	6	6	10	16	25	35	50	50
Utilization category AC2 and AC3											
Switching of three-phase motors											
Rated operational current I_e open and enclosed	220V A	12	15	18	22	24	32	40	50	63	74
	230V A	11,5	14,5	18	22	24	32	40	50	62	74
	240V A	11	14	18	22	24	32	40	50	62	74
	380-400V A	10	14	18	22	24	32	40	50	62	74
	415V A	9	14	18	22	23	30	40	50	62	74
	440V A	9	14	18	22	23	30	40	50	62	74
	500V A	8,9	11,9	15	15	22,5	28,5	28,5	44	54	64,5
	660-690V A	6,7	9	12	12	17,5	21	21	33	42	49
	1000V A	-	-	-	-	-	-	-	-	-	-
Rated operational power of three-phase motors 50-60Hz	220-230V kW	3	4	5	6	6	8,5	11	12,5	18,5	22
	240V kW	3	4	5	7	7	9	11,5	13,5	19	23
	380-400V kW	4	5,5	7,5	11	11	15	18,5	22	30	37
	415V kW	4,5	6	8,5	12	12	16	20	24	33	40
	440V kW	4,5	6	8,5	12	12	16	20	24	33	40
	500V kW	5,5	7,5	10	10	15	18,5	18,5	30	37	45
	660-690V kW	5,5	7,5	10	10	15	18,5	18,5	30	37	45
	1000V kW	-	-	-	-	-	-	-	-	-	-

1) Suitable at 690V for: earthed-neutral systems, overvoltage category I to IV, pollution degree 3 (standard-industry): $U_{imp} = 8kV$.
Data for other conditions on request.

Contactors

Data according to IEC 947-4-1, EN 60947-4-1, VDE 0660

Type	K3-90	K3-115	K3-116	K3-151	K3-176	K3-210	K3-260	K3-316	K3-450	K3-550	K3-700	K3-860	K3-1000	K3-1200
V AC	1000	1000	1000	1000	1000	1000	1000	1000	1000	1000	690	690	690	690
A	1100	1200	1200	1500	2000	2100	2600	3200	4500	5500	7000	8600	10000	12000
A	540	600	600	720	840	1020	1200	1500	2400	3000	-	-	-	-
A	950	1100	1000	1200	1500	1600	2100	2600	4500	5500	7000	8000	8000	10000
A	850	1000	1000	1200	1500	1600	2100	2600	4500	5500	7000	8000	8000	10000
A	600	600	800	1000	800	1200	1900	2300	3200	4400	5600	6900	7000	8000
A	450	450	400	500	600	700	850	1000	-	-	-	-	-	-
A	160	200	200	250	300	350	450	600	700	800	1000	1100	1200	1350
kW	60	76	76	95	114	133	171	228	266	304	381	419	457	514
kW	63	79	79	99	119	139	179	238	279	318	398	438	478	537
kW	66	83	83	103	124	145	187	249	291	332	415	457	498	561
kW	105	131	131	165	197	230	296	394	460	526	658	724	789	888
kW	110	138	138	173	208	242	311	415	485	554	692	762	831	935
kW	115	143	143	179	215	251	323	430	503	574	718	790	862	970
kW	121	152	152	190	228	266	342	456	533	609	762	838	914	1028
kW	138	173	173	216	260	303	389	518	606	692	866	952	1039	1169
kW	182	228	228	285	343	400	514	684	800	914	1143	1257	1371	1543
kW	191	239	239	298	358	418	537	715	836	955	1195	1314	1434	1613
kW	221	277	216	345	415	433	546	727	692	911	-	-	-	-
A	145	170	170	180	200	280	360	400	550	600	800	875	960	1080
kW	55	64	64	68	76	106	137	152	209	228	304	333	365	411
kW	57	67	67	71	79	111	143	159	219	239	318	348	382	430
kW	59	70	70	74	83	116	150	166	228	249	332	363	399	448
kW	95	111	111	118	131	184	237	263	362	395	526	575	631	710
kW	100	117	117	124	138	193	249	277	381	415	554	606	665	748
kW	104	122	122	129	143	201	259	287	395	431	575	628	690	776
kW	110	129	129	137	152	213	274	304	419	457	609	666	731	823
kW	125	147	147	155	173	242	312	346	476	519	692	757	831	935
kW	165	194	194	205	228	320	412	457	628	685	914	1000	1097	1234
kW	173	202	202	215	239	334	430	478	657	717	956	1045	1147	1290
kW	166	187	216	277	346	388	499	554	692	866	-	-	-	-
mm ²	95	120	95	95	120	240	2x150	2x(30x6)	2x(40x5)	2x(50x5)	2x(60x5)	2x(60x6)	2x(60x6)	2x(60x8)
A	90	115	115	150	175	210	260	315	450	550	700	860	1000	1200
A	90	115	115	150	175	210	260	315	450	550	700	860	1000	1200
A	90	115	115	150	175	210	260	315	450	550	700	860	1000	1200
A	90	115	115	150	175	210	260	315	450	550	700	860	1000	1200
A	90	115	115	150	175	210	260	315	450	550	700	860	1000	1200
A	90	115	115	150	175	210	260	315	450	550	700	860	1000	1200
A	79	79	115	150	175	210	260	315	450	550	700	860	1000	1200
A	60	60	100	120	140	150	180	240	400	500	630	700	860	1000
A	45	45	45	60	70	85	100	125	200	250	-	-	-	-
kW	25	33	30	40	50	60	75	90	132	175	225	280	325	390
kW	27	35	35	45	55	65	80	100	140	185	235	290	335	400
kW	45	55	55	75	90	110	132	160	250	300	400	500	580	680
kW	49	63	59	80	95	115	140	180	257	315	415	515	600	710
kW	49	63	63	85	100	125	150	190	270	335	450	530	630	750
kW	55	55	75	90	100	132	160	210	300	375	500	600	720	850
kW	55	55	90	110	132	132	160	210	375	500	630	700	850	1000
kW	55	55	55	75	90	110	132	160	280	355	-	-	-	-

Contactors, Motor-Starters
Circuit Breakers
Manual Motor-Starters
Switches
AC-Main Switches
DC-Switch Disconnectors
Push Buttons
Representatives, Suppliers

Contactors

Data according to IEC 947-4-1, EN 60947-4-1, VDE 0660

Main Contacts	Type	K(G)3-10	K(G)3-14	K(G)3-18	K(G)3-22	K(G)3-24	K(G)3-32	K(G)3-40	K3-50	K3-62	K3-74
Utilization category AC4											
Switching of squirrel cage motors, inching											
Rated operational current I_e	220V A	12	15	18	18	24	30	40	50	63	63
open and enclosed	230V A	11,5	14,5	18	18	24	30	40	50	62	62
	240V A	11	14	18	18	24	32	40	50	62	62
	380-400V A	10	14	18	18	24	32	40	50	62	62
	415V A	9	14	18	18	23	30	37	45	60	60
	440V A	9	14	18	18	23	30	37	45	55	55
	500V A	9	12	16	16	17,5	21	21	33	42	42
	660V A	7	9	9	9	17	20	20	31	40	40
	690V A	6,5	8,5	8,5	8,5	17	20	20	31	40	40
	1000V A	-	-	-	-	-	-	-	-	-	-
Rated operational power of three-phase motors 50-60Hz	220-230V kW	3	4	5	5	6	8,5	11	12,5	18,5	18,5
	240V kW	3	4	5	5	7	9	11,5	13,5	19	19
	380-400V kW	4	5,5	7,5	7,5	11	15	18,5	22	30	30
	415V kW	4,5	6	8,5	8,5	12	16	20	24	33	33
	440V kW	4,5	6	8,5	8,5	12	16	20	24	33	33
	500V kW	5,5	7,5	10	10	15	18,5	18,5	30	37	37
	660-690V kW	5,5	7,5	10	10	15	18,5	18,5	30	37	37
	1000V kW	-	-	-	-	-	-	-	-	-	-
Utilization category AC5a											
Switching of gas discharge lamps											
Rated operational current I_e per pole at 220/230V											
Fluorescent lamps, uncompensated and serial compensated											
	A	20	20	25	25	40	52	64	88	96	104
	A	7	9	9	9	18	22	22	30	40	40
	A	22,5	22,5	28	28	45	58	72	98	108	117
Metal halide lamps ¹⁾ , uncompensated											
	A	12	15	19	19	30	39	48	66	72	78
	A	7	9	9	9	18	22	22	30	40	40
Mercury-vapour lamps ²⁾ , uncompensated											
	A	22,5	25	28	28	45	58	72	99	108	117
	A	7	9	9	9	18	22	22	30	40	40
Mixed light lamps ³⁾											
	A	20	20	25	25	40	52	64	88	96	104
LED-Lamps											
consider the inrush current of the lamp ballast and $\cos\phi$ of the lamp.											
max. lamps per pole ($I_{rLED} \leq I_{rn}$)						= $\frac{\text{inrush current of contactor}}{\text{inrush current of lamp/EVG}}$					
max inrush current of contactor	A	282	282	282	282	564	705	705	987	1269	1268
Utilization category AC5b											
Switching of incandescent lamps⁴⁾											
Rated operational current I_e per pole at 220/230V	A	12,5	12,5	12,5	12,5	25	31	31	43	56	56

1) Metal halide lamps and sodium-vapour lamps (high- and low-pressure lamps)

2) High-pressure lamps

3) Blended lamps, containing a mercury high-pressure unit and a tungsten helix in a fluorescent glass bulb (daylight lamps)

4) Current inrush approx. $16 \times I_e$

Contactors

Data according to IEC 947-4-1, EN 60947-4-1, VDE 0660

Type	K3-90	K3-115	K3-151	K3-176	K3-210	K3-260	K3-316	K3-450	K3-550	K3-700	K3-860	K3-1000	K3-1200
A	85	98	55	63	85	100	120	150	180	230	280	340	400
A	85	98	55	63	85	100	120	150	180	230	280	340	400
A	85	98	55	63	85	100	120	150	180	230	280	340	400
A	85	85	55	63	85	100	120	150	180	230	280	340	400
A	85	85	55	63	85	100	120	150	180	230	280	340	400
A	85	85	55	63	85	100	120	150	180	230	280	340	400
A	85	85	-	-	-	-	-	-	-	-	-	-	-
A	60	60	-	-	-	-	-	-	-	-	-	-	-
A	57,5	57,5	-	-	-	-	-	-	-	-	-	-	-
A	-	-	-	-	-	-	-	-	-	-	-	-	-
kW	25	30	15	18,5	25	30	37	45	51	68	80	110	132
kW	27	32	15,5	19	26	31	38	47	53	71	83	115	137
kW	45	45	25	30	45	55	63	75	90	120	150	185	220
kW	49	49	25	33	45	55	65	80	100	132	160	200	230
kW	49	49	30	34	48	55	67	85	100	132	160	200	230
kW	55	55	25	30	55	65	75	100	110	150	185	220	257
kW	55	55	25	30	55	65	75	100	110	150	185	220	257
kW	-	-	-	-	-	-	-	-	-	-	-	-	-
A	100	120	120	140	180	220	280	360	450	570	700	850	1000
A	55	70	85	100	130	160	200	300	360	460	550	660	800
A	112	144	120	140	180	220	280	360	450	570	700	850	1000
A	85	90	95	110	140	180	230	300	380	490	610	750	890
A	55	70	75	85	110	140	170	260	300	400	480	580	700
A	112	144	120	140	180	220	280	360	450	570	700	850	1000
A	55	70	75	85	110	140	170	260	300	400	480	580	700
A	100	120	100	120	160	200	250	320	400	500	600	700	800
	$\text{max. lamps per pole } (I_{nLED} \leq I_n) = \frac{\text{inrush current of contactor}}{\text{inrush current of lamp/EVG}}$												
A	1551	1692	2115	2820	2961	3666	4512	6345	7755	9870	12126	14100	16920
A	69	75	100	120	160	190	220	260	315	440	500	560	630

Contactors

Data according to IEC 947-4-1, EN 60947-4-1, VDE 0660

Main Contacts		Type	K(G)3-10	K(G)3-14	K(G)3-18	K(G)3-22	K(G)3-24	K(G)3-32	K(G)3-40	K3-50	K3-62	K3-74
Utilization category AC6a												
Transformer primary switching												
at inrush		n	30	30	30	30	30	30	30	30	30	30
Rated operational current I_e	400V	A	4,5	5,5	7,5	7,5	10,5	13,5	13,5	20	27	33
Rated operational power	220-230V	kVA	1,8	2,2	3	3	4,2	5,4	5,4	8	10,7	13
dependent on inrush n	240V	kVA	1,9	2,3	3,1	3,1	4,3	5,6	5,6	8,3	11,2	13,5
	380-400V	kVA	3,1	3,8	5,2	5,2	7,3	9,3	9,3	13,5	18,5	22,5
For different inrush-factors x	415-440V	kVA	3,4	4,2	5,7	5,7	8	10,2	10,2	15	20,5	25
use the following formula:	500V	kVA	3,9	4,8	6,5	6,5	9	11,5	11,5	17	23	28
$P_x = P_n \cdot (n/x)$	660-690V	kVA	5,4	6,5	9	9	12,5	16	16	24	32	39
Utilization category AC6b												
Switching of three-phase capacitors												
Maximum inrush current (peak value)												
as multiple k of the												
capacitor rated current												
Rated operational current I_e	500V	k	35	25	20	20	25	25	25	25	25	20
		A	8	12	15,5	15,5	23	32	32	45	60	70
Rated operational current	220-230V	kVAr	3	4,5	6	6	8,5	12	12	17	24	28
($\sin\phi \rightarrow 1$)	240V	kVAr	3,5	5	6,5	6,5	9,5	13	13	18,5	25	29
	380-400V	kVAr	5	7,5	10	10	15	20	20	29	39	46
For different multiples x	415-440V	kVAr	5,5	8	11	11	16	22	22	32	43	50
use the following formula:	500V	kVAr	7	10	13	13	20	26	26	39	50	58
$P_x = P_k \cdot (k/x)$	660-690V	kVAr	7	10	13	13	20	26	26	40	50	58
Switching of reactive capacitor banks												
Rated operational current I_e	690V	A	8	13	18	20	28	36	42	48	72	108 ¹⁾
Rated operational power	220-230V	kVAr	2,9	5	7	7,5	11	14	16	20	28	33
	240V	kVAr	3,1	5,4	7	8	11	14	17	20	28	36
	380-400V	kVAr	5	9	12,5	13	20	25	27,5	33,3	50	75 ¹⁾
	415-440V	kVAr	5,5	9,5	13	14	22	27	30	36	53	75 ¹⁾
	500V	kVAr	6	11	15	17	25	30	36	40	60	75
	660-690V	kVAr	8	15	20	22	33	41	48	55	82	100
	1000V	kVAr	-	-	-	-	-	-	-	-	-	-
Utilization category DC1												
Switching of resistive load												
Time constant $L/R \leq 1\text{ms}$												
Rated operational current I_e	1 pole	24V	A	20	25	32	32	50	65	80	110	130
		60V	A	20	25	32	32	50	65	80	110	130
		110V	A	6	6	6	6	10	10	12	12	12
		220V	A	0,8	0,8	0,8	0,8	1,4	1,4	1,4	1,4	1,4
	3 poles in series	24V	A	20	25	32	32	50	65	80	110	130
		60V	A	20	25	32	32	50	65	80	110	130
		110V	A	20	25	32	32	50	65	80	110	130
		220V	A	16	20	20	20	30	35	35	63	80
Utilization category DC3 and DC5												
Switching of shunt motors and series motors												
Time constant $L/R \leq 15\text{ms}$												
Rated operational current I_e	1 pole	24V	A	20	25	32	32	50	65	80	110	130
		60V	A	6	6	6	6	30	30	30	60	60
		110V	A	1,2	1,2	1,2	1,2	1,8	1,8	1,8	1,8	1,8
		220V	A	0,2	0,2	0,2	0,2	0,2	0,2	0,25	0,25	0,25
	3 poles in series	24V	A	20	25	32	32	50	65	80	110	130
		60V	A	20	25	32	32	40	40	40	80	80
		110V	A	20	20	20	20	40	40	40	80	80
		220V	A	2,5	2,5	2,5	2,5	4	4	4	5	5

1) Consider resistive load (I_{ln}). see page 62



Contactors

Data according to IEC 947-4-1, EN 60947-4-1, VDE 0660

Type	K3-90	K3-115	K3-151	K3-176	K3-210	K3-260	K3-316	K3-450	K3-550	K3-700	K3-860	K3-1000	K3-1200
n	30	30	30	30	30	30	30	30	30	30	30	30	30
A	38	50	65	80	90	120	142	203	248	315	390	450	540
kVA	15	20	25	30	34	45	54	77	95	120	148	170	200
kVA	15,5	20,5	27	33	37	50	59	80	100	130	160	185	220
kVA	26	34	45	55	60	80	95	140	170	210	270	310	370
kVA	29	38	46	57	63	85	100	145	175	220	280	320	380
kVA	33	43	55	69	75	100	120	170	210	270	330	380	460
kVA	45	60	56	69	100	135	160	200	250	320	350	500	600
k	20	20	20	20	25	20	20	20	20	20	20	20	20
A	87	100	120	155	195	225	255	300	370	440	520	680	760
kVAr	33	38	45	60	75	90	100	115	145	170	200	260	290
kVAr	36	42	52	62	78	94	104	120	150	175	205	270	300
kVAr	57	65	80	100	130	155	170	200	250	300	350	450	500
kVAr	60	70	95	110	135	165	175	210	260	310	360	465	520
kVAr	70	80	100	130	170	194	220	260	320	380	450	590	660
kVAr	70	80	100	130	170	194	220	260	320	380	450	590	660
A	115	144	115	140	200	225	250	330	420	550	600	680	760
kVAr	45	55	43	53	76	85	95	125	160	209	228	260	290
kVAr	45	55	45	55	80	90	100	130	170	220	240	280	310
kVAr	80	100	75	90	130	145	160	210	270	350	390	440	480
kVAr	100	120	80	100	140	160	170	230	290	380	420	470	530
kVAr	105	125	95	120	170	190	210	280	350	450	500	570	640
kVAr	120	148	125	150	200	230	260	350	450	600	650	700	800
kVAr	160	200	155	200	300	340	400	500	650	-	-	-	-
A	160	200	-	-	-	-	-	-	-	-	-	-	-
A	160	200	-	-	-	-	-	-	-	-	-	-	-
A	20	25	-	-	-	-	-	-	-	-	-	-	-
A	2	2,5	-	-	-	-	-	-	-	-	-	-	-
A	160	200	200	250	350	400	450	600	760	1000	1100	1200	1350
A	160	200	200	250	350	400	450	600	760	1000	1100	1200	1350
A	160	200	150	170	250	280	315	400	480	560	630	800	900
A	100	160	80	100	150	180	200	250	315	400	450	500	600
A	160	200	-	-	-	-	-	-	-	-	-	-	-
A	85	110	-	-	-	-	-	-	-	-	-	-	-
A	2	2,5	-	-	-	-	-	-	-	-	-	-	-
A	0,5	0,5	-	-	-	-	-	-	-	-	-	-	-
A	160	200	-	-	-	-	-	-	-	-	-	-	-
A	100	110	-	-	-	-	-	-	-	-	-	-	-
A	100	110	-	-	-	-	-	-	-	-	-	-	-
A	7	8	-	-	-	-	-	-	-	-	-	-	-

Contactors







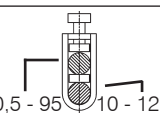

Data according to IEC 947-4-1, EN 60947-4-1, VDE 0660

Main Contacts		Type	K(G)3-10	K(G)3-14	K(G)3-18	K(G)3-22	K(G)3-24	K(G)3-32	K(G)3-40	K3-50	K3-62	K3-74
Maximum ambient temperature												
Operation	open	°C	-40 to +60 (+90) ¹⁾									
	enclosed	°C	-40 to +40									
with thermal overload relay	open	°C	-25 to +60									
	enclosed	°C	-25 to +40									
Storage		°C	-50 to +90									
Short circuit protection for contactors without thermal overload relay												
Coordination-type "1" according to IEC 947-4-1 Contact welding without hazard of persons												
max. fuse size	gL (gG)	A	63	63	63	63	100	100	100	160	160	160
Coordination-type "2" according to IEC 947-4-1 Light contact welding accepted												
max. fuse size	gL (gG)	A	25	35	35	35	50	50	50	100	125	125
Contact welding not accepted												
max. fuse size	gL (gG)	A	16	16	16	16	25	35	35	50	63	63
For contactors with thermal overload relay the device with the smaller admissible backup fuse (contactor or thermal overload relay) determines the fuse size.												
Cable cross-sections for contactors without thermal overload relay												
1 cable per clamp												
main connector	solid or stranded	mm ²	 0,75 - 6				 1,5 - 25			 4 - 50		
	flexible	mm ²	1 - 4				2,5 - 16			10 - 35		
	flexible with multicore cable end	mm ²	0,75 - 4				1,5 - 16			6 - 35		
2 cables per clamp												
	solid or stranded	mm ²	6+(1-6) / 4+(0,75-4) 2,5+(0,75-2,5) / 1,5+(0,75-1,5)				16+(2,5-16) / 10+(4-16) 6+(4-16) / 4+(2,5-16)			50+4 / 35+6 / 25+(6-16) 16+(6-16) / 10+(6-16)		
	flexible	mm ²	6+(1,5-4) / 4+(1-4) 2,5+(0,75-2,5) / 1,5+(0,75-1,5)				16+(2,5-6) / 10+(4-10) 6+(4-16) / 4+(2,5-16)			50+(4-10) / 35+(4-16) 25+(4-25) / 16+(4-16)		
1 cable per clamp												
main connector	solid	AWG	18 - 10				16 - 10			12 - 10		
	flexible	AWG	18 - 10				14 - 4			10 - 0		
2 cables per clamp												
	solid	AWG	10+(16-10) / 12+(18-12) 14+(18-14) / 16+(18-16)				10+(16-10) / 12+(18-12) 14+(18-14) / 16+(18-16)			10+(12-10) / 12+12		
	flexible	AWG	10+(14-10) / 12+(18-12) 14+(18-14) / 16+(18-16)				4+(18-12) / 6+(18-8) 8+(18-8) / 10+(18-12)			1+(12-10) / 2+(8-12) 3+(12-8) / 4+(10-6)		
Frequency of operations z Contactors without thermal overload relay												
	without load	1/h	10000				7000			7000		
	AC3, I _e	1/h	600				600			400		
	AC4, I _e	1/h	120				120			120		
	DC3, I _e	1/h	600				600			400		
Mechanical life												
AC operated	S x 10 ⁶		10				10			10		
DC operated	S x 10 ⁶		10				10			10		
DC-solenoid operated (KG3)	S x 10 ⁶		50				50			-		
Short time current												
	10s-current	A	96	120	144	176	184	240	296	450	504	592
	120s-current	A	42	52	58	66	80	97	110	195	203	222
Power loss per pole contact resistance												
	at I _e /AC3 400V	W	0,21	0,35	0,5	0,75	0,7	1,3	2	2,2	3,9	5,5
		mOhm	2,1	1,8	1,5	1,5	1,2	1,2	1,2	1	1	1
Resistance to shock acc. to IEC 68-2-27												
Shock time 20ms sine-wave	NO	g	10	10	10	10	8	8	8	8	8	8
	NC	g	6	6	6	6	-	-	-	-	-	-

1) With reduced control voltage range 0,9 up to 1,0 x U_s and with reduced rated current I_e/AC1 according to I_e/AC3

Contactors

Data according to IEC 947-4-1, EN 60947-4-1, VDE 0660

Type	K3-90	K3-115	K3-116	K3-151	K3-176	K3-210	K3-260	K3-316	K3-450	K3-550	K3-700	K3-860	K3-1000	K3-1200		
°C	-40 bis +60 (+90) ¹⁾															
°C	-40 to +40															
°C	-25 to +60															
°C	-25 to +40															
°C	-50 to +90															
A	250	250	200	250	315	400	450	500	630	630	800	1000	1000	1250		
A	160	200	160	200	250	315	400	400	500	560	-	-	-	-		
A	100	125	125	160	200	250	315	-	-	-	-	-	-	-		
mm ²	 0,5 - 95 10 - 120		 busbar 18 x 4 screw M8		 busbar 25 x 6 screw M10		 busbar 30 x 5 screw M12		 busbar 40 x 6 screw M12		 busbar 50 x 8 screw M12		 busbar 50 x 8 screw M14		 busbar 50 x 10 screw 2 x M12	
mm ²	0,5 - 70 25 - 95															
mm ²	0,5 - 70 10 - 95															
mm ²	0,5 - 95 + 10 - 120															
mm ²	0,5 - 70 + 25 - 95															
AWG	18 - 10	-														
AWG	18 - 3/0	8 - 4/0														
AWG	-	-														
AWG	18 - 3/0 + 8 - 4/0	-														
1/h	3000		1200			1200			1200				300			
1/h	300		240			150			50				20			
1/h	120		-			-			25				-			
1/h	300		-			-			-				-			
S x 10 ⁶	5		10			5			5				5 ³⁾			
S x 10 ⁶	5		10			5			5				5 ³⁾			
S x 10 ⁶	-		-			-			-				-			
A	680	880	920	1200	1400	1800	2200	2600	3600	4400	5600	6900	8000	9600		
A	275	330	410	500	575	800	900	1000	1400	1750	2200	2600	3000	3600		
W	4,8	7,9	7,9	9	11	8	11	14,9	26,3	33,3	49	59,2	60	72		
mOhm	0,6	0,5	0,5	0,4	0,35	0,18	0,16	0,15								
g	7	7	-	-	-	-	-	-	-	-	-	-	-	-		
g	5	5	-	-	-	-	-	-	-	-	-	-	-	-		

1) With reduced control voltage range 0,9 up to 1,0 x U_s and with reduced rated current I_b/AC1 according to I_b/AC3

2) With reduced control voltage range 1,0 x U_s and with reduced rated current I_b/AC1 according to I_b/AC3

3) After each 1x10⁶ operations magnetic core and built-in auxiliary contact block must be changed

Contactors

Data according to IEC 947-4-1, EN 60947-4-1, VDE 0660

Auxiliary Contacts			Type	K(G)3-10	K(G)3-14	K(G)3-18	K(G)3-22	K(G)3-24	K(G)3-32	K(G)3-40	K3-50	K3-62	K3-74
Rated insulation voltage U_i ¹⁾			V~	690				-		-			
Thermal rated current I_{th} to 690V													
Ambient temperature			40°C A	10				(16) ⁵⁾		-			
			60°C A	6				(12) ⁵⁾		-			
Utilization category AC15													
Rated operational current I_e			220-240V A	3				(12) ⁵⁾		-			
			380-415V A	2				(4) ⁵⁾		-			
			440V A	1,6				(4) ⁵⁾		-			
			500V A	1,2				(3) ⁵⁾		-			
			660-690V A	0,6				(1) ⁵⁾		-			
Utilization category DC13													
Rated operational current I_e			60V A	3,5				(8) ⁵⁾		-			
			110V A	0,5				(1) ⁵⁾		-			
			220V A	0,1						-			
Short circuit protection short-circuit current 1kA, contact welding not accepted max. fuse size			gL (gG) A	20				(25) ⁵⁾		-		-	
Control Circuit Power consumption of coils													
AC operated			inrush VA	33-45				90-115		140-165			
			sealed VA	7-10				9-13		13-18			
			W	2,6-3				2,7-4		5,4-7			
DC operated			inrush W	75				140		200			
double winding coil			sealed W	2				2		6			
DC solenoid operated (KG3)			inrush W	3				4		-			
			sealed W	3				4		-			
Operation range of coils in multiples of control voltage U_c													
			AC operated	0,85-1,1				0,85-1,1		0,85-1,1			
			DC operated	0,8-1,1				0,8-1,1		0,8-1,1			
Switching time at control voltage $U_c \pm 10\%$ ^{2) 3)}													
AC operated			make time ms	8-16				10-25		12-28			
			release time ms	5-13				8-15		8-15			
			arc duration ms	10-15				10-15		10-15			
DC operated			make time ms	8-12				10-20		12-23			
double winding coil			release time ms	8-13				10-15		10-18			
			arc duration ms	10-15				10-15		10-15			
DC solenoid operated (KG3)			make time ms	65 - 85				65 - 85		-			
			release time ms	20 - 30 ⁴⁾				20 - 30 ⁴⁾		-			
			arc duration ms	10-15				10-15		-			
Cable cross-section													
Auxiliary connector			solid mm ²	0,75-6				-		-			
			flexible mm ²	1-4				-		-			
			flexible with multicore cable end mm ²	0,75-4				-		-			
Magnet coil			solid mm ²	0,75-2,5				0,75-2,5		0,75-2,5			
			flexible mm ²	0,5-2,5				0,5-2,5		0,5-2,5			
			flexible with multicore cable end mm ²	0,5-1,5				0,5-1,5		0,5-1,5			
Clamps per pole				2				2		2			
Auxiliary connector			solid AWG	18 - 10				-		-			
			flexible AWG	18 - 10				-		-			
Magnet coil			solid AWG	14 - 12				14 - 12		14 - 12			
			flexible AWG	18 - 12				18 - 12		18 - 12			
Clamps per pole				2				2		2			

1) Suitable for: earthed-neutral systems, overvoltage category I to IV, pollution degree 3 (standard-industry): $U_{imp} = 8kV$. Data for other conditions on request

2) Total breaking time = release time + arc duration

3) Values for delay of the release time of the make contact and the make time of the break contact will be increased, if magnet coils are protected against voltage peaks (varistor, RC-unit, diode-unit)

4) with built-in coil suppressor 5) for contactors KG3...A.. only

Contactors

Data according to IEC 947-4-1, EN 60947-4-1, VDE 0660

Type	K3-90	K3-115	K3-116	K3-151	K3-176	K3-210	K3-260	K3-316	K3-450	K3-550	K3-700	K3-860	K3-1000	K3-1200
V~	-	-	-	-	-	-	-	-	690	-	690	-	690	-
A	-	-	-	-	-	-	-	-	10	-	10	-	10	-
A	-	-	-	-	-	-	-	-	-	-	-	-	-	-
-	-	-	-	-	-	-	-	-	-	-	-	-	-	-
A	-	-	-	-	-	-	-	-	3	-	3	-	3	-
A	-	-	-	-	-	-	-	-	2	-	2	-	2	-
A	-	-	-	-	-	-	-	-	1,5	-	1,5	-	1,5	-
A	-	-	-	-	-	-	-	-	1,5	-	1,5	-	1,5	-
A	-	-	-	-	-	-	-	-	1	-	1	-	1	-
A	-	-	-	-	-	-	-	-	-	-	-	-	-	-
A	-	-	-	-	-	-	-	-	1	-	1	-	1	-
A	-	-	-	-	-	-	-	-	0,5	-	0,5	-	0,5	-
A	-	-	-	-	-	-	-	-	-	-	-	-	-	-
A	-	-	-	-	-	-	-	-	10	-	10	-	10	-
VA	165-220	-	-	350	-	-	360	-	800-950	-	1350-1600	-	2400	-
VA	2,5-5	-	-	5	-	-	5	-	9-11	-	21-25	-	70	-
W	2,5-5	-	-	5	-	-	5	-	9-11	-	21-25	-	70	-
W	250	-	-	350	-	-	360	-	700-850	-	1300-1550	-	2100	-
W	5	-	-	5	-	-	5	-	8-10	-	18-22	-	60	-
W	-	-	-	-	-	-	-	-	-	-	-	-	-	-
W	-	-	-	-	-	-	-	-	-	-	-	-	-	-
ms	0,85-1,1 0,8-1,1	-	-	0,85-1,1 0,85-1,1	-	-	0,85-1,1 0,85-1,1	-	0,85-1,1 0,85-1,1	-	0,85-1,1 0,85-1,1	-	0,85-1,1 0,85-1,1	-
ms	20-35	-	-	30-60	-	-	40-60	-	50-100	-	50-100	-	50-100	-
ms	35-50	-	-	30-80	-	-	15-45	-	150-200 / 500-1000 ¹⁾	-	25-50	-	25-50	-
ms	10-15	-	-	-	-	-	-	-	-	-	-	-	-	-
ms	20-35	-	-	30-60	-	-	40-60	-	-	-	-	-	-	-
ms	35-50	-	-	30-80	-	-	15-45	-	-	-	-	-	-	-
ms	10-15	-	-	-	-	-	-	-	-	-	-	-	-	-
ms	-	-	-	-	-	-	-	-	-	-	-	-	-	-
ms	-	-	-	-	-	-	-	-	-	-	-	-	-	-
ms	-	-	-	-	-	-	-	-	-	-	-	-	-	-
mm ²	-	-	-	-	-	-	-	-	0,75-2,5	-	0,75-2,5	-	0,75-2,5	-
mm ²	-	-	-	-	-	-	-	-	0,75-2,5	-	0,75-2,5	-	0,75-2,5	-
mm ²	-	-	-	-	-	-	-	-	-	-	-	-	-	-
mm ²	0,75-2,5	-	-	1-2,5	-	-	1-2,5	-	1-2,5	-	1-2,5	-	1-2,5	-
mm ²	0,5-2,5	-	-	1-2,5	-	-	1-2,5	-	1-2,5	-	1-2,5	-	1-2,5	-
mm ²	0,5-1,5	-	-	-	-	-	-	-	-	-	-	-	-	-
mm ²	2	-	-	2	-	-	2	-	2	-	2	-	2	-
AWG	-	-	-	-	-	-	-	-	16 - 12	-	16 - 12	-	16 - 12	-
AWG	-	-	-	-	-	-	-	-	16 - 12	-	16 - 12	-	16 - 12	-
AWG	14 - 12	-	-	16 - 12	-	-	16 - 12	-	16 - 12	-	16 - 12	-	16 - 12	-
AWG	18 - 12	-	-	16 - 12	-	-	16 - 12	-	16 - 12	-	16 - 12	-	16 - 12	-
AWG	2	-	-	2	-	-	2	-	2	-	2	-	2	-

1) Normal or delayed drop is adjustable

Contactors, Motor-Starters
Circuit Breakers
Manual Motor-Starters
Switches
AC-Main Switches
DC-Switch Disconnectors
Push Buttons
Representatives, Suppliers

Contactors

Data according to IEC 947-4-1, EN 60947-4-1, VDE 0660

Main Contacts	Type	K2-09	K2-12	K2-16	K2-23	K2-30	K2-37	K2-45	K2-60	K85	K110
Rated insulation voltage U_i ¹⁾	V~	690	690	690	690	690	690	690	690	750	750
Making capacity I_{eff} at $U_e = 690V\sim$	A	200	200	200	400	500	500	700	900	1100	1200
Breaking capacity I_{eff} 400V~	A	180	180	200	380	400	400	600	800	950	1100
K2-09 to K2-16 $\cos\phi = 0,65$ 500V AC	A	150	150	180	300	370	370	500	700	850	1100
K2-23 to K3-1200 $\cos\phi = 0,35$ 690V AC	A	100	100	150	260	340	340	400	500	600	600
	A	-	-	-	-	-	-	-	-	-	-
Utilization category AC1											
Switching of resistive load											
Rated operational current $I_e (=I_{th})$ at 40°C, open	A	25	25	25	45	50	50	80	100	150	170
Rated operational power of three-phase resistive loads 50-60Hz, $\cos\phi = 1$	220V kW	9,5	9,5	9,5	17	19	19	30	38	57	64
	230V kW	10	10	10	18	20	20	31,5	40	59	67
	240V kW	10,5	10,5	10,5	18,5	20,5	20,5	33	41	62	70
	380V kW	16,5	16,5	16,5	29,5	33	33	52	65	98	111
	400V kW	17,5	17,5	17,5	31	34,5	34,5	55	69	103	117
	415V kW	18	18	18	32	36	36	57	71	107	122
	440V kW	19	19	19	34	38	38	61	76	114	129
	500V kW	21,5	21,5	21,5	39	43	43	69	86	130	147
	660V kW	28,5	28,5	28,5	51	57	57	91	114	171	194
	690V kW	29,5	29,5	29,5	53,5	60	60	95	119	179	203
Rated operational current $I_e (=I_{th})$ at 60°C, enclosed	A	20	25	25	35	40	40	63	80	100	125
Rated operational power of three-phase resistive loads 50-60Hz, $\cos\phi = 1$	220V kW	7,5	9,5	9,5	13	15	15	24	30	38	47
	230V kW	8	10	10	13,5	16	16	25	31,5	40	49
	240V kW	8	10,5	10,5	14,5	16,5	16,5	26	33	41	52
	380V kW	13	16,5	16,5	23	26	26	41	52	65	82
	400V kW	13,5	17,5	17,5	24	27,5	27,5	43	55	69	86
	415V kW	14	18	18	25	28,5	28,5	45	57	71	89
	440V kW	15	19	19	26,5	30	30	48	61	71	95
	500V kW	17	21,5	21,5	30	34	34	54	69	86	116
	660V kW	22,5	28,5	28,5	40	45	45	72	91	114	142
	690V kW	23,5	29,5	29,5	42	48	48	75	95	119	149
Minimum cross-section of conductor at load with $I_e (=I_{th})$	mm ²	4	4	4	10	10	10	25	35	50	70
Utilization category AC2 and AC3											
Switching of three-phase motors											
Rated operational current I_e open and enclosed	220V A	12	15	18	23	30	37	45	63	85	110
	230V A	11,5	14,5	17,5	23	30	37	45	61	85	110
	240V A	11	14	17	23	30	37	45	60	85	110
	380-400V A	10	12	16	23	30	37	45	60	85	110
	415-440V A	9	12	16	23	30	37	45	60	85	110
	500V A	9	12	16	23	30	30	45	55	85	110
	660V A	7	9	9	17,5	21	21	33	42	60	60
	690V A	6,5	8,5	8,5	17	20	20	31	40	58	58
Rated operational power of three-phase motors 50-60Hz	220-230V kW	3	4	5	6	8,5	11	12,5	18,5	25	33
	240V kW	3	4	5	7	9	11,5	13,5	19	27	35
	380-400V kW	4	5,5	7,5	11	15	18,5	22	30	45	55
	415V kW	4,5	6	8,5	12	16	20	24	33	49	63
	440V kW	4,5	6	8,5	12	16	20	24	33	49	63
	500V kW	5,5	7,5	10	15	18,5	18,5	30	37	55	55
	660-690V kW	5,5	7,5	7,5	15	18,5	18,5	30	37	55	55

1) Suitable at 690V for: earthed-neutral systems, overvoltage category I to IV, pollution degree 3 (standard-industry): $U_{imp} = 8kV$.
Data for other conditions on request.

Contactors

Data according to IEC 947-4-1, EN 60947-4-1, VDE 0660

Main Contacts	Type	K2-09	K2-12	K2-16	K2-23	K2-30	K2-37	K2-45	K2-60	K85	K110
Utilization category AC4											
Switching of squirrel cage motors, inching											
Rated operational current I_e	220V A	12	15	16	23	30	37	45	63	85	98
open and enclosed	230V A	11,5	14,5	16	23	30	37	45	61	85	98
	240V A	11	14	16	23	30	37	45	60	85	98
	380-400V A	10	12	16	23	30	37	45	60	85	85
	415V A	9	12	16	21	28	37	45	60	85	85
	440V A	9	12	16	21	28	37	45	60	85	85
	500V A	9	12	16	17	23	23	45	55	85	85
	660V A	7	9	9	13	17	17	33	42	60	60
	690V A	6,5	8,5	8,5	12,5	16,5	16,5	31	40	57,5	57,5
Rated operational power of three-phase motors	220-230V kW	3	4	5	6	8,5	11	12,5	18,5	25	30
50-60Hz	240V kW	3	4	5	7	9	11,5	13,5	19	27	32
	380-400V kW	4	5,5	7,5	11	15	18,5	22	30	45	45
	415-440V kW	4,5	6	8,5	11	15	20	24	33	49	49
	500V kW	5,5	7,5	10	11	15	15	30	37	55	55
	660-690V kW	5,5	7,5	7,5	11	15	15	30	37	55	55
Utilization category AC5a											
Switching of gas discharge lamps											
Rated operational current I_e per pole at 220/230V											
Fluorescent lamps, uncompensated	A	20	20	20	35	40	40	65	85	100	120
Fluorescent lamps, compensated	A	7	9	9	18	22	22	30	40	55	70
Fluorescent lamps, dual-connection	A	22,5	22,5	22,5	41	45	45	72	90	112	144
Metal-halide lamps ¹⁾ , uncompensated	A	12	15	15	28	30	30	50	62	85	90
Metal-halide lamps ¹⁾ , compensated	A	7	9	9	18	22	22	30	40	55	70
Mercury-vapour lamps ²⁾ , uncompensated	A	22,5	25	25	41	45	45	72	90	112	144
Mercury-vapour lamps ²⁾ , compensated	A	7	9	9	18	22	22	30	40	55	70
Mixed light lamps ³⁾	A	20	20	20	35	40	40	65	85	100	120
Utilization category AC5b											
Switching of incandescent lamps⁴⁾											
Rated operational current I_e per pole at 220/230V	A	12,5	12,5	12,5	25	31	31	43	56	69	75
Utilization category AC6a											
Transformer primary switching											
at inrush	n	30	30	30	30	30	30	30	30	30	30
Rated operational current I_e	400V A	4,5	5,5	7,5	10,5	13,5	13,5	20	27	38	50
Rated operational power dependent on inrush n	220-230V kVA	1,8	2,2	3	4,2	5,4	5,4	8	10,7	15	20
	240V kVA	1,9	2,3	3,1	4,3	5,6	5,6	8,3	11,2	15,5	20,5
	380-400V kVA	3,1	3,8	5,2	7,3	9,3	9,3	13,5	18,5	26	34
For different inrush-factors x use the following formula: $P_x = P_n \cdot (n/x)$	415-440V kVA	3,4	4,2	5,7	8	10,2	10,2	15	20,5	29	38
	500V kVA	3,9	4,8	6,5	9	11,5	11,5	17	23	33	43
	660-690V kVA	5,4	6,5	9	12,5	16	16	24	32	45	60
Utilization category DC1											
Switching of resistive load											
Time constant L/R ≤ 1 ms	1 pole 24V A	20	25	25	45	50	50	80	100	150	170
Rated operational current I_e	60V A	20	25	25	45	50	50	80	100	150	170
	110V A	6	6	6	10	10	10	12	12	20	25
	220V A	0,8	0,8	0,8	1,4	1,4	1,4	1,4	1,4	2	2,5
	2 poles in series 24V A				45	50	50				
	60V A				45	50	50				
	110V A				45	50	50				
	220V A				10	10	10				
	3 poles in series 24V A	20	25	25	45	50	50	80	100	150	170
	60V A	20	25	25	45	50	50	80	100	150	170
	110V A	20	25	25	45	50	50	80	100	150	170
	220V A	16	20	20	30	35	35	63	80	100	160

- 1) Metal halide lamps and sodium-vapour lamps (high- and low-pressure lamps)
- 2) High-pressure lamps
- 3) Blended lamps, containing a mercury high-pressure unit and a tungsten helix in a fluorescent glass bulb (daylight lamps)
- 4) Current inrush approx. $16 \times I_e$
- 5) With central compensation pay attention to the current inrush (capacitor switching contactors)

Contactors

Data according to IEC 947-4-1, EN 60947-4-1, VDE 0660

Main Contacts	Type	K2-09	K2-12	K2-16	K2-23	K2-30	K2-37	K2-45	K2-60	K85	K110	
Utilization category DC3 and DC5												
Switching of shunt motors and series motors												
Time constant L/R ≤15ms	1 pole 24V	A	20	25	25	45	50	50	80	100	150	170
Rated operational current I _e	60V	A	6	6	6	30	30	30	60	60	85	110
	110V	A	1,2	1,2	1,2	1,8	1,8	1,8	1,8	1,8	2	2,5
	220V	A	0,2	0,2	0,2	0,2	0,2	0,2	0,25	0,25	0,5	0,5
	2 poles in series 24V	A				45	50	50				
	60V	A				45	50	50				
	110V	A				30	30	30				
	220V	A				1,8	1,8	1,8				
3 poles in series 24V	A	20	25	25	45	50	50	80	100	150	170	
	60V	A	20	25	25	40	40	40	80	80	100	110
	110V	A	20	20	20	40	40	40	80	80	100	110
	220V	A	2,5	2,5	2,5	4	4	4	5	5	7	8
Maximum ambient temperature												
Operation	open	°C										
	enclosed	°C										
with thermal overload relay	open	°C										
	enclosed	°C										
Storage		°C										
Short circuit protection												
for contactors without thermal overload relay												
Coordination-type "1" according to IEC 947-4-1												
Contact welding without hazard of persons												
max. fuse size	gL (gG)	A	63	63	63	80	80	80	160	160	250	250
Coordination-type "2" according to IEC 947-4-1												
Light contact welding accepted												
max. fuse size	gL (gG)	A	25	35	35	50	50	50	100	125	160	200
Contact welding not accepted												
max. fuse size	gL (gG)	A	16	16	16	25	35	35	50	63	100	125
For contactors with thermal overload relay the device with the smaller admissible backup fuse (contactor or thermal overload relay) determines the fuse size.												
Cable cross-sections												
for contactors without thermal overload relay												
main connector	solid or stranded	mm ²	0,75 - 4			1,5-10 + 1,5-6			4 - 35 ²⁾		10 - 70 ²⁾	
	flexible	mm ²	0,75 - 2,5			1,5-6 + 1,5-4			6 - 25 ²⁾		10 - 70 ²⁾	
Cables per clamp	flexible with multicore cable end	mm ²	0,5 - 2,5			1,5-6 + 1,5-4			4 - 25		10 - 35	
			2			1+1			1		1	
main connector	solid	AWG	14 - 10			14 - 10 + 14 - 10			10		10	
	flexible	AWG	18 - 10			14 - 8 + 14 - 10			10 - 2		6 - 0	
Cables per clamp			2			1+1			1		1	
Frequency of operations z												
Contactors without thermal overload relay												
	without load	1/h	10000			7000			7000		3000	
	AC3, I _e	1/h	600			600			400		300	
	AC4, I _e	1/h	120			120			120		120	
	DC3, I _e	1/h	600			600			400		300	
Mechanical life												
AC operated		S x 10 ⁶	10			10			10		5	
DC operated with economy resistor		S x 10 ⁶	10			10			10		5	
Short time current												
	10s-current	A	96	120	144	184	240	296	360	504	680	880
Power loss per pole												
	at I _e /AC3 400V	W	0,21	0,26	0,4	0,63	1,1	1,7	1,8	3,6	4,3	6,0
Resistance to shock acc. to IEC 68-2-27												
Shock time 20ms sine-wave	NO	g	10	10	10	8	8	8	8	8	7	7
	NC	g	6	6	6	5	5	5	-	-	5	5

1) With reduced control voltage range 0,9 up to 1,0 x U_s and with reduced rated current I_e/AC1 according to I_e/AC3

2) Maximum cable cross-section with prepared conductor

Contactors

Data according to IEC 947-4-1, EN 60947-4-1, VDE 0660

Auxiliary Contacts	Type	K2-09	K2-12	K2-16	K2-23	K2-30	K2-37	K2-45	K2-60	K85	K110
Rated insulation voltage U_i ¹⁾	V AC		690			690			-		690
Thermal rated current I_{th} to 690V											
Ambient temperature	40°C A		16			16			-		16
	60°C A		12			12			-		12
Utilization category AC15											
Rated operational current I_e	220-240V A		12			12			-		12
	380-415V A		4			4			-		6
	440V A		4			4			-		6
	500V A		3			3			-		4
	660-690V A		1			1			-		2
Utilization category DC13											
Rated operational current I_e	60V A		8			8			-		8
	110V A		1			1			-		1
	220V A		0,1			0,1			-		0,1
Short circuit protection short-circuit current 1kA, contact welding not accepted max. fuse size gL (gG) A For contactors with thermal overload relay the device with the smaller admissible control fuse (contactor or thermal overload relay) determines the fuse.			25			-			-		25
Control Circuit											
Power consumption of coils											
AC operated	inrush VA		33-45			90-115		140-165		280-350	350-420
	sealed VA		7-10			9-13		13-18		16-23	23-29
	W		2,6-3			2,7-4		5,4-7		4-6	6-7,3
DC operated	inrush W		75			140		200		170	320
with economic circuit	sealed W		2			2		6		2	4
Operation range of coils in multiples of control voltage U_s											
	AC operated		0,85-1,1			0,85-1,1		0,85-1,1		0,85-1,1	0,85-1,1
	DC operated		0,8-1,1			0,8-1,1		0,8-1,1		0,8-1,1	0,8-1,1
Switching time at control voltage $U_s \pm 10\%$ ^{2) 3)}											
AC operated	make time ms		8-16			10-25		12-28		13-30	13-30
	release time ms		5-13			8-15		8-15		8-15	8-15
	arc duration ms		10-15			10-15		10-15		10-15	10-15
DC operated	make time ms		8-12			10-20		12-23		20-30	20-30
with AC magnet system	release time ms		8-13			10-15		10-18		10-18	10-18
	arc duration ms		10-15			10-15		10-15		10-15	10-15
Cable cross-section											
Auxiliary connector	solid mm ²		0,75-4			-		-		0,75-2,5	0,75-2,5
	flexible mm ²		0,75-2,5			-		-		0,75-2,5	0,75-2,5
	flexible with multicore cable end mm ²		0,5-2,5			-		-		0,5-1,5	0,5-1,5
Magnet coil	solid mm ²		0,75-2,5			0,75-2,5		0,75-2,5		0,75-2,5	0,75-2,5
	flexible mm ²		0,5-2,5			0,5-2,5		0,5-2,5		0,5-2,5	0,5-2,5
	flexible with multicore cable end mm ²		0,5-1,5			0,5-1,5		0,5-1,5		0,5-1,5	0,5-1,5
Clamps per pole			2			2		2		2	2

1) Suitable for: earthed-neutral systems, overvoltage category I to IV, pollution degree 3 (standard-industry): $U_{imp} = 8kV$. Data for other conditions on request

2) Total breaking time = release time + arc duration

3) Values for delay of the release time of the make contact and the make time of the break contact will be increased, if magnet coils are protected against voltage peaks (varistor, RC-unit, diode-unit)

Contactors for North America

Data according to UL508

Main Contacts (cULus)		Type	K(G)3-10	K(G)3-14	K(G)3-18	K(G)3-22	K(G)3-24	K(G)3-32	K(G)3-40	K3-50	K3-62	K3-74
Rated operational current "General Use"		A	25	25	30	30	50	65	80	110	120	130
Motor DOL 3-phase at 60Hz												
Rated operational current	600V	A	10	14	18	22	22	27	34	44	52	66
Rated operational power	110-120V	hp	1½	2	2	3	5	5	7½	10	10	10
	200V	hp	3	3	5	5	7½	10	10	15	20	25
	220-240V	hp	3	3	7½	7½	10	10	15	20	25	30
	277V	hp	3	5	7½	7½	7½	10	15	20	25	30
	380-415V	hp	5	5	10	10	10	15	20	25	30	40
	440-480V	hp	5	7½	10	15	15	20	25	30	40	50
	550-600V	hp	7½	10	15	20	20	25	30	40	50	50
Motor DOL 1-phase at 60Hz												
Rated operational current	600V	A	10	14	18	22	22	27	34	44	52	66
Rated operational power of AC motors at 60Hz (1ph)	110-120V	hp	½	¾	1	1½	1½	2	3	3	5	7½
	200V	hp	1	1,5	2	3	3	5	7½	7½	10	15
	220-240V	hp	1½	2	3	3	5	5	7½	10	15	15
	277V	hp	2	3	3	5	5	7½	10	10	15	15
	380-415V	hp	3	3	5	5	5	7½	10	15	20	20
	440-480V	hp	3	5	5	7½	7½	10	15	20	25	25
	550-600V	hp	3	5	7½	10	10	15	20	25	30	30
Motor DOL 3-phase according to ANSI A17.5												
Rated operational current	600V	A	-	-	-	-	15	22	-	27	37	-
Rated operational power of 3-phase motors for elevators (500.000 operations)	110-120V	hp	-	-	-	-	2	3	-	3	5	-
	200V	hp	-	-	-	-	3	5	-	7½	10	-
	220-240V	hp	-	-	-	-	5	7½	-	7½	10	-
	440-480V	hp	-	-	-	-	10	15	-	20	25	-
	550-600V	hp	-	-	-	-	10	20	-	25	30	-
Rated current 2 series contacts	600V	A	-	-	-	-	22	27	-	44	52	66
Fuse Class RK5 / Short-circuit current		A/kA	50/5	50/5	70/5	90/5	90/5	125/5	175/5	200/5	250/5	300/5
Fuse Class T / Short-circuit current		A/kA	45/100	50/100	70/100	90/100	110/100	150/100	150/100	175/100	175/100	175/100
Rated voltage		V	600	600	600	600	600	600	600	600	600	600
Auxiliary Contacts (cULus)			A600	A600	A600	A600	-	-	-	-	-	-

Main Contacts (cULus)		Type	K2-09	K2-12	K2-16	K2-23	K2-30	K2-45	K2-60	K85	K110
Rated operational current "General Use"		A	25	25	25	40	40	72	90	125	150
Motor DOL 3-phase at 60Hz											
Rated operational power	110-120V	hp	1½	2	2	3	5	-	-	15	-
	200V	hp	2	3	3	5	7½	10	15	-	30
	220-240V	hp	3	3	5	7½	10	15	20	35	40
	440-480V	hp	5	7½	10	15	20	30	40	65	75
	550-600V	hp	7½	10	15	20	25	40	50	85	100
Motor DOL 1-phase at 60Hz											
Rated operational power	110-120V	hp	½	¾	1	1½	2	3	5	8	10
	200V	hp	1	2	2	3	3	5	7½	-	20
	220-240V	hp	1½	2	3	3	5	7½	10	20	20
Fuse / Short-circuit current		A/kA	30/5	40/5	50/5	60/5	110/5	175/5	175/5	-	300/5
Rated voltage		V	600	600	600	600	600	600	600	600	600
Auxiliary Contacts (cULus)			A600	A600	A600	A600	A600	-	-	A600	A600

Contactors for North America

Data according to UL508

Type	K3-90	K3-115	K3-116	K3-151	K3-176	K3-210	K3-260	K3-316	K3-450	K3-550	K3-700	K3-860	K3-1000	K3-1200
A	160	200	150	180	220	250	300	350	420	520	700	810	-	1215
A	85	99		125	150	190	240	300	300	400	550	700	-	1000
hp	15	20	-	-	-	-	-	-	-	-	-	-	-	-
hp	25	35	30	40	50	60	75	100	125	150	200	250	-	450
hp	35	40	40	50	60	75	100	125	125	150	250	300	-	450
hp	-	-	-	-	-	-	-	-	-	-	-	-	-	-
hp	50	60	-	-	-	-	-	-	-	-	-	-	-	-
hp	65	75	75	100	125	150	200	250	250	350	500	600	-	900
hp	85	100	100	125	150	200	250	300	250	350	500	600	-	900
A	86	103		125	150	-	-	-	-	-	-	-	-	-
hp	8	10	10	15	25	-	-	-	-	-	-	-	-	-
hp	15	20	20	-	-	-	-	-	-	-	-	-	-	-
hp	20	25	-	25	30	40	50	50	-	-	-	-	-	-
hp	20	25	-	-	-	-	-	-	-	-	-	-	-	-
hp	30	40	-	-	-	-	-	-	-	-	-	-	-	-
hp	40	50	-	-	-	-	-	-	-	-	-	-	-	-
hp	50	60	-	-	-	-	-	-	-	-	-	-	-	-
A	-	-	-	-	-	-	-	-	-	-	-	-	-	-
hp	-	-	-	-	-	-	-	-	-	-	-	-	-	-
hp	-	-	-	-	-	-	-	-	-	-	-	-	-	-
hp	-	-	-	-	-	-	-	-	-	-	-	-	-	-
hp	-	-	-	-	-	-	-	-	-	-	-	-	-	-
A	-	-	-	-	-	-	-	-	-	-	-	-	-	-
A/kA	300/10	300/10	225/10	300/10	350/10	400/18	500/18	500/18	1200/18	1200/18	2000/30	2000/30	-	2000/42
A/kA	300/100 ³⁾	300/100 ³⁾	-	-	-	-	-	-	-	-	-	-	-	-
V	600	600	600	600	600	600	600	600	600	600	600	600	600	600
	-	-	-	-	-	-	-	-	A600	A600	A600	A600	-	A600

Main Contacts (cULus)	Type	K3-18NK	K3-18NBK	K3-24K	K3-32K	K3-50K	K3-62K	K3-74K	K3-90K	K3-115K	
Rated operational power of 3-phase cap. banks 110-120V at 60Hz (3ph)	200V	kVAr	0-3,5	0-3,5	3-5,5	3-7	6,5-10	6,5-15	6,5-18 ¹⁾	10-24	10-28 ²⁾
	220-240V	kVAr	0-6	0-6	4,5-10	4,5-12,5	10-16,7	10-25	10-32 ¹⁾	17-40	17-46 ²⁾
		kVAr	0-7	0-7	5,5-11	5,5-15	12,5-20	12,5-30	12,5-36 ¹⁾	20-47	20-56 ²⁾
	440-480V	kVAr	0-15	0-15	11,5-25	11,5-30	25-40	25-60	25-72 ¹⁾	40-95	40-114 ²⁾
550-600V	kVAr	0-18	0-18	14,5-30	14,5-35	31-50	31-75	31-90 ¹⁾	50-120	50-143 ²⁾	
Fuse Class RK5 / Short-circuit current	A/kA	70/5	70/5	90/5	125/5	200/5	250/5	300/5	300/10	300/10	
Fuse Class T / Short-circuit current	A/kA	80/100	80/100	110/100	150/100	175/100	175/100	175/100	300/100 ³⁾	300/100 ³⁾	
Rated voltage	V	600	600	600	600	600	600	600	600	600	
Auxiliary Contacts (cULus)		A600	A600	-	-	-	-	-	-	-	

1) Consider the max. thermal current of the contactor K3-74A: I_{th} 130A

2) Consider the min. cross-section of conductor at max. load

3) Class T and Class RK1

Contactors

Contact Life

For selection of the suitable contactor-type according to supply voltage, power rating and application (utilization category AC1, AC3 or AC4) use contact life characteristic diagram.

For the most common supply voltages four scales of power ratings P_n are provided for each utilization category.

Select contactor-type according to utilization category **AC3** (breaking current $I_a = I_e$) using the **motor rating** scales to the right, according to utilization category **AC4** (breaking current $I_a = 6 \times I_e$) using the **motor rating** scales to the left. ¹⁾

Select contactor-type according to utilization category **AC1** (breaking current $I_a = I_e/AC1$) using the **breaking current** scale. ¹⁾

For contactors frequently used under AC3/AC4-mixed service conditions calculate contact life with the formula:

$$M = \frac{AC3}{1 + \frac{\%AC4}{100} \times \left(\frac{AC3}{AC4} - 1 \right)}$$

M = Contact life (switching cycles) for AC3/AC4-mixed operations
 AC3 = Contact life (switching cycles) for AC3 operations (normal switching conditions). Breaking current $I_a =$ rated motor current I_e .
 AC4 = Contact life (switching cycles) for AC4 operations (inching). Breaking current $I_a =$ multiples of rated motor current I_e .
 %AC4 = Percents of AC4-operations related to the total cycles.

Motor Rating

$P_n = AC4$

660/ 500V 380/ 220/
690V 400V 230V

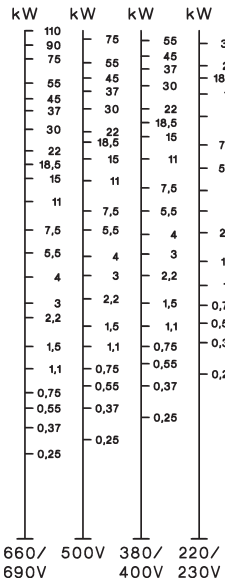

Motor Rating

$P_n = AC3$

660/ 500V 380/ 220/
690V 400V 230V

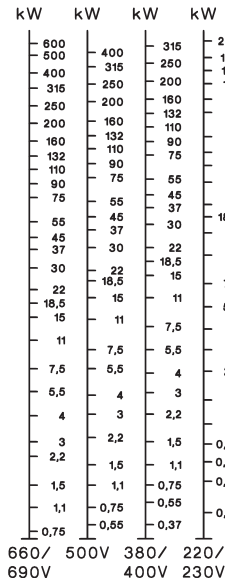

Breaking Current

$I_a (= I_e = AC1)$

A

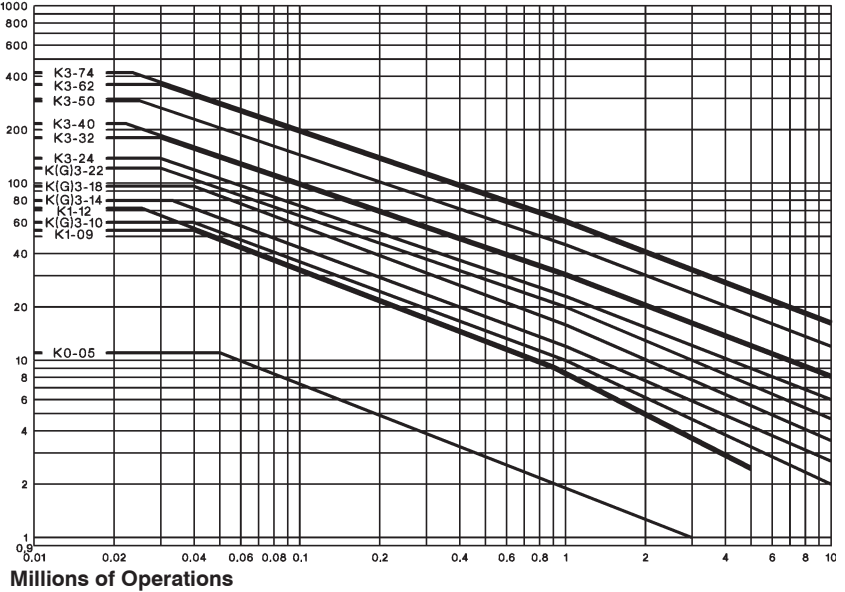

Motor Rating

$P_n = AC4$

660/ 500V 380/ 220/
690V 400V 230V

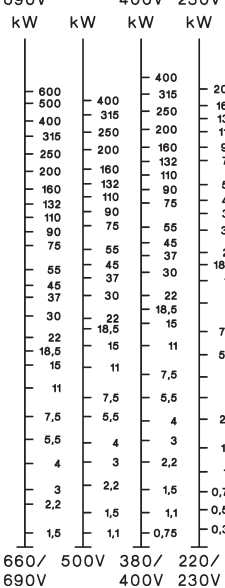

Motor Rating

$P_n = AC3$

660/ 500V 380/ 220/
690V 400V 230V

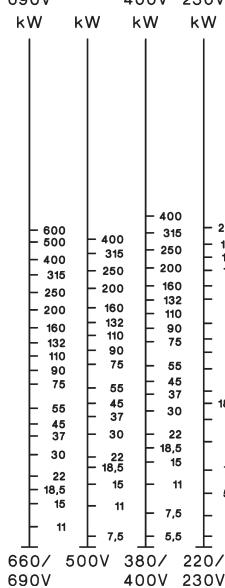

Breaking Current

$I_a (= I_e = AC1)$

A

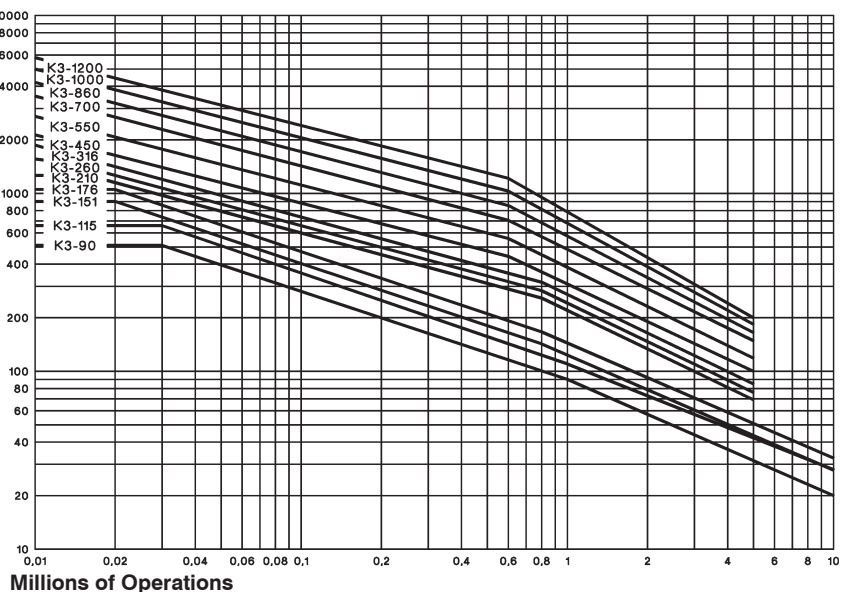

1) Pay attention to the approved rated values of the selected contactor according to the national approvals

Contactors

Utilization Categories

For easier choice of devices and in order to make the comparison of different products simpler are utilization categories for contactors and motor-starters according to IEC 947-4-1 and VDE 0660 Part

102, for control circuit devices and switching elements according to IEC 947-5-1 and VDE 0660 Part 200 determined. The table offers different utilization categories, typical applications and assorted test conditions.

Type of current	Category	Typical applications	Rated operational current	Test conditions for the number of on-load operating cycles						Test conditions for making and breaking capacities					
				Make			Break			Make			Break		
				I/I_e	U/U_e	$\cos\phi$	I_c/I_e	U_c/U_e	$\cos\phi$	I/I_e	U/U_e	$\cos\phi$	I_c/I_e	U_c/U_e	$\cos\phi$
Alternating Current	AC1	Non-inductive or slightly inductive loads resistance furnaces	all values	1	1	0,95	1	1	0,95	1,5	1,05	0,8	1,5	1,05	0,8
	AC2	Slip-ring motors: starting, switching off	all values	2,5	1	0,65	2,5	1	0,65	4	1,05	0,65	4	1,05	0,65
	AC3	Squirrel-cage motors: starting, switching off motors during running	$I_e < 17A$ $I_e > 17A$ $I_e > 100A$	6 6 6	1 1 1	0,65 0,35 0,35	1 1 1	0,17 0,17 0,17	0,65 0,35 0,35	10 10 10	1,05 1,05 1,05	0,45 0,45 0,35	8 8 8	1,05 1,05 1,05	0,45 0,45 0,35
	AC4	Squirrel-cage motors: starting, plugging, inching	$I_e < 17A$ $I_e > 17A$ $I_e > 100A$	6 6 6	1 1 1	0,65 0,35 0,35	6 6 6	1 1 1	0,65 0,35 0,35	12 12 12	1,05 1,05 1,05	0,45 0,45 0,35	10 10 10	1,05 1,05 1,05	0,45 0,45 0,35
	AC5a	Switching of electric discharge lamp controls	all values	-	-	-	-	-	-	3	1,05	0,45	3	1,05	0,45
	AC5b	Switching of incandescent lamps	all values	-	-	-	-	-	-	1,5	1,05	¹⁾	4	1,05	¹⁾
	AC6a	Switching of transformers	$I_e > 100A$ $I_e > 100A$	- -	- -	- -	- -	- -	- -	4,5 4,5	1,05 1,05	0,45 0,35	3,6 3,6	1,05 1,05	0,45 0,35
	AC6b	Switching of capacitors	-	-	-	-	-	-	-	²⁾			²⁾		
	AC7a	Slightly inductive loads in household appliances and similar applications	all values	-	-	-	-	-	-	1,5	1,05	0,8	1,5	1,05	0,8
	AC7b	Motor loads for household applications	$I_e > 100A$ $I_e > 100A$	- -	- -	- -	- -	- -	- -	8 8	1,05 1,05	0,45 0,35	6 6	1,05 1,05	0,45 0,35
	AC8a	Hermetic refrigerant compressor motor control with manual resetting of overload releases	$I_e > 100A$ $I_e > 100A$	- -	- -	- -	- -	- -	- -	6 6	1,05 1,05	0,45 0,35	6 6	1,05 1,05	0,45 0,35
	AC8b	Hermetic refrigerant compressor motor control with automatic resetting of overload releases	$I_e > 100A$ $I_e > 100A$	- -	- -	- -	- -	- -	- -	6 6	1,05 1,05	0,45 0,35	6 6	1,05 1,05	0,45 0,35
	AC12	Control of resistive loads and solid state loads with isolation by opto couplers	all values	-	-	-	-	-	-	1	1	0,9	1	1	0,9
	AC13	Control of solid state loads with transformer isolation	all values	-	-	-	-	-	-	10	1,1	0,65	1,1	1,1	0,65
	AC14	Control of small electromagnetic loads ($\leq 72VA$)	-	-	-	-	-	-	-	6	1,1	0,7	6	1,1	0,7
AC15	Control of electromagnetic load ($> 72VA$)	-	10	1	0,7	1	1	0,4	10	1,1	0,3	10	1,1	0,3	
Direct Current	DC1	Non-inductive or slightly inductive loads resistance furnaces	all values	1	1	1	1	1	1	1,5	1,05	1	1,5	1,05	1
	DC3	Shunt-motors: starting, plugging, inching dynamic braking of d.c. motors	all values	2,5	1	2	2,5	1	2	4	1,05	2,5	4	1,05	2,5
	DC5	Series-motors: starting, plugging, inching dynamic braking of d.c. motors	all values	2,5	1	7,5	2,5	1	7,5	4	1,05	15	4	1,05	15
	DC6	Switching of incandescent lamps	all values	-	-	-	-	-	-	1,5	1,05	¹⁾	4	1,05	¹⁾
	DC12	Control of resistive loads and solid state loads with isolation by opto couplers	all values	-	-	-	-	-	-	1	1	1	1	1	1
	DC13	Control of electromagnets	all values	1	1	≤ 300	1	1	≤ 300	1,1	1,1	≤ 300	1,1	1,1	≤ 300
	DC14	Control of electromagnetic loads having economy resistors in circuit	all values	-	-	-	-	-	-	10	1,1	15	10	1,1	15

U_e Rated operational voltage, U Voltage before make, U_r Recovery voltage, I_e Rated operational current, I Current make, I_c Current broken

1) Test with incandescent lamps

2) Test conditions according to standard

Accessories

Data according to IEC 947-5-1, EN 60947-5-1, VDE 0660

Type		HN	HTN	HA	HB	HKT HKA	HKF HKB	K2-DK K2-SK	K2-TP	K2-L ²⁾	
Rated insulation voltage U_i ¹⁾	V AC	690	690	690	690	690	690	690	690	690	
Thermal rated current I_{th} to bis 690V Ambient temperature	max. 40°C	A	10	10	25	10	10	16	26	10	10
	max. 60°C	A	6	6	20	6	-	-	-	-	6
Frequency of operations z	1/h	3000	-	3000	3000	-	-	-	1200	3000	
Mechanical life	S x 10 ⁶	10	10	10	10	-	-	-	1	10	
Power loss per pole at I _e /AC1	W	0,5	0,5	1,5	0,5	-	-	-	-	-	
Utilization category AC15											
Rated operational current I _e	220-240V	A	3	3	6	3	3	3	-	4	3
	380-400V	A	2	2	3	2	2	2	-	3	2
	440V	A	1,6	1,6	2	1,6	1,5	1,5	-	2	1,6
	500V	A	1,2	1,2	2	1,2	1,5	1,5	-	2	1
	660-690V	A	0,6	0,6	1	0,6	1	1	-	2	0,5
Utilization category DC13											
Rated operational current I _e	60V	A	2	2	8	2	-	-	-	2,5	2
	110V	A	0,4	0,4	1	0,4	0,5	0,5	-	1,5	0,4
	220V	A	0,1	0,1	0,1	0,1	0,2	0,2	-	0,2	0,1
Short circuit protection short-circuit current 1kA, contact welding not accepted max. fuse size gL (gG) A											
		20	20	25	20	10	10	-	10	10	
For contactors with thermal overload relay or auxiliary contacts the device with the smaller admissible control fuse (contactor or thermal overload relay) determines the fuse size.											
Cable cross-sections											
solid or stranded	mm ²	0,75-2,5	0,75-2,5	0,75-2,5	0,75-2,5	0,75-2,5	0,75-2,5	0,75-2,5	1-2,5	0,75-2,5	
	flexible	mm ²	0,75-2,5	0,75-2,5	0,75-2,5	0,75-2,5	0,75-2,5	0,75-2,5	0,75-2,5	0,75-2,5	
	flexible with multicore cable end	mm ²	0,5-1,5	0,5-1,5	0,5-1,5	0,5-1,5	0,5-1,5	0,5-1,5	0,5-1,5	0,5-1,5	
solid	AWG	14 - 12	14 - 12	14 - 12	14 - 12	14 - 12	14 - 12	14 - 12	14 - 12	14 - 12	
	flexible	AWG	18 - 12	18 - 12	18 - 12	18 - 12	18 - 12	18 - 12	18 - 12	18 - 12	
Cables per clamp		2	2	2	2	2	2	2	2	2	

Data according to CSA, UL and CUL

Type		HN	HTN	HA	HB..	HKA, HKT HKF	K2-DK K2-SK	K2-TP	K2-L ²⁾
Rated operational current "General Use"	A	10	10	16	10	10	-	10	-
Rated operational voltage	max. V AC	600	600	600	600	600	-	600	600
Auxiliary Contacts		A600	A600	A600	A600	A600	-	A600	Intermittent duty

1) Suitable for: earthed-neutral systems, overvoltage category I to IV, pollution degree 3 (standard-industry): U_{imp} = 8kV. Data for other conditions on request.

2) Command duration min. 30ms, 10% duty cycle, max. 30 eec.

Leistungsschütze und Zubehör

Schaltbilder

Hilfskontaktblöcke

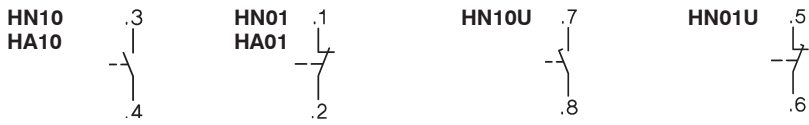

Aufsteckbare Tastkontakte

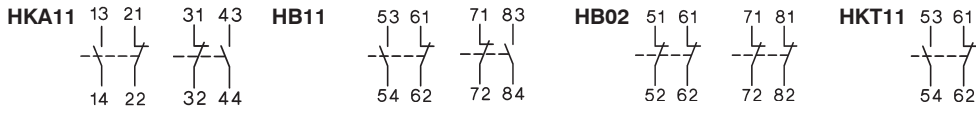
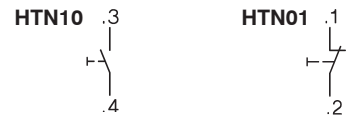

HKA11, HB11, HB02:
Die richtige Klemmenbezeichnung ergibt sich durch die Montage

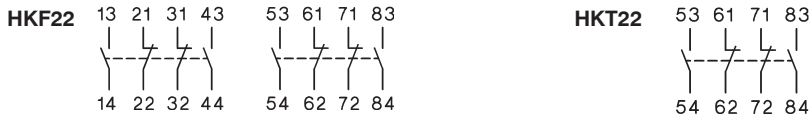

Anzeigeelemente

Elektronisches Zeitrelais

K3-T180 240

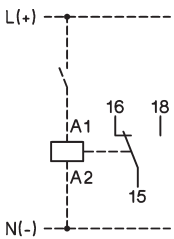

Spulenstromindikator

K2-ING K2-INR

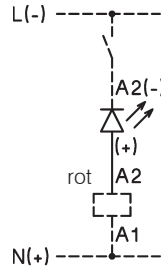

Spannungsindikator

K2-UN K2-UNR

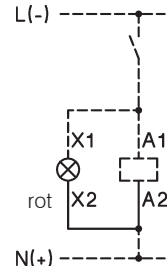

Mechanische Verklantung

K2-L..

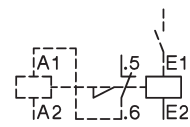

Sicherungshalter

mit Gleichrichter

K2-F



K2-RF1 K2-RF3

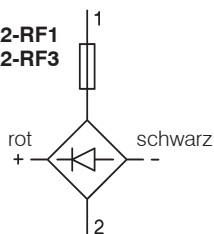

Die im Schaltbild angegebenen Farben beziehen sich auf die vom Gerät abgehenden Anschlußleitungen.

Interface

K2-IM

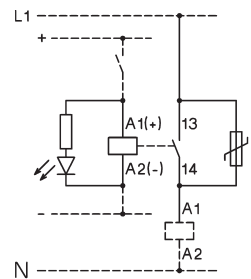

Schaltwegverstellung bei Hilfskontaktblöcken HKF22 für Schütze K3-450 bis K3-860

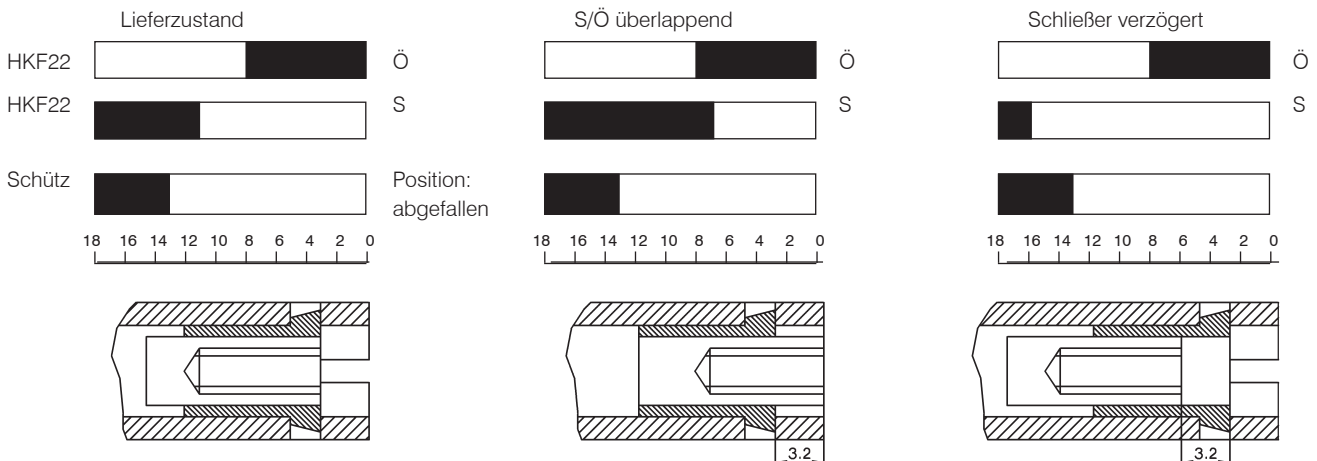

Standardstellung der Einstellschraube

Schraube 4 Umdrehungen herausdrehen

Schraube 4 Umdrehungen hineindrehen

Leistungsschütze

Maße

wechselstrombetätigt

K3-10N..
K3-14N..
K3-18N..
K3-22N..

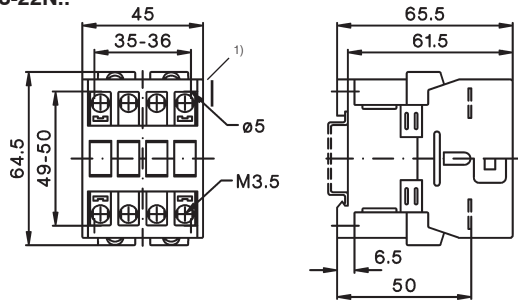

K3-24..
K3-32..
K3-40..

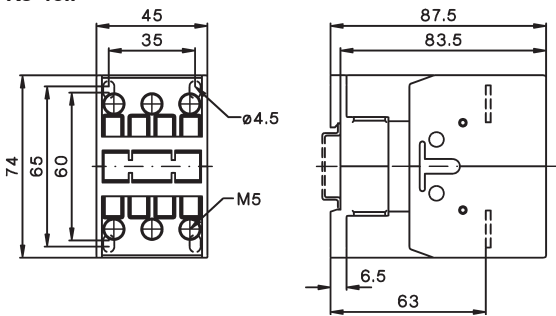

K3-50..
K3-62..
K3-74..

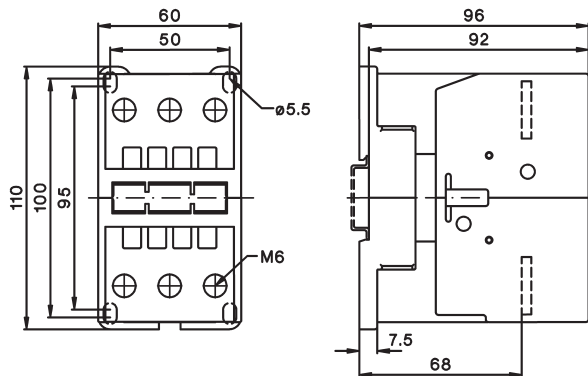

wechsel- und gleichstrombetätigt

K3-90..
K3-115..

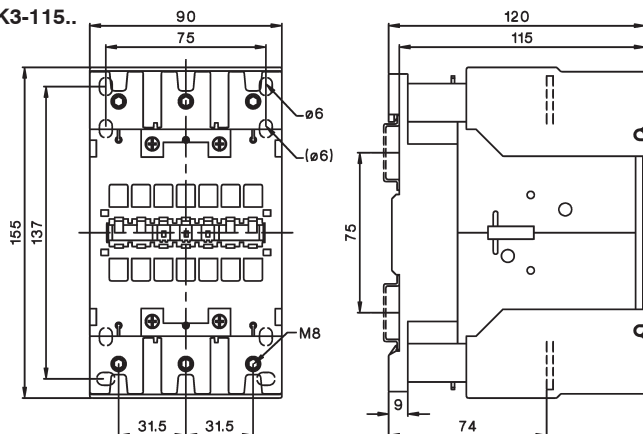

gleichstrombetätigt

KG3-10..
KG3-14..
KG3-18..
KG3-22..

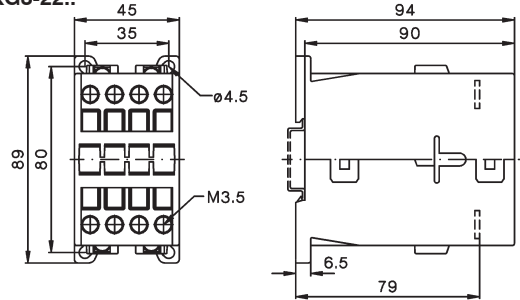

KG3-24..
KG3-32..
KG3-40..

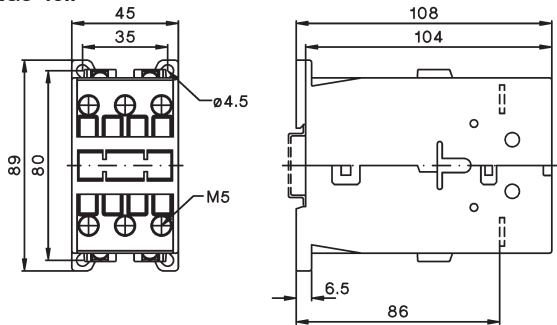

KG3-50..
KG3-62..
KG3-74..

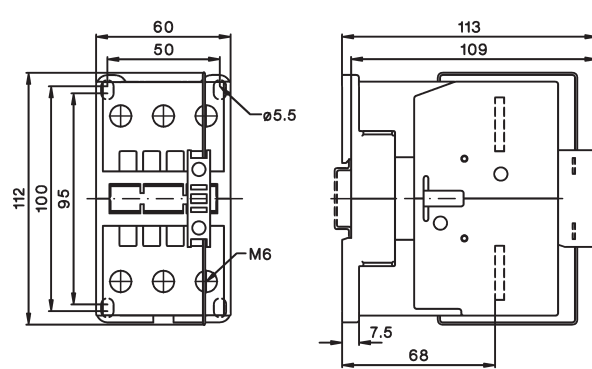

1) Mindestseitenabstände zu leitfähigen
Teilen bei Spulenspannungen:
500V $U_{imp}=6kV$ 2mm
660-690V $U_{imp}=8kV$ 4,5mm

Leistungsschütze

Maße, wechsel- und gleichstrombetätigt

K3-151..
K3-176..

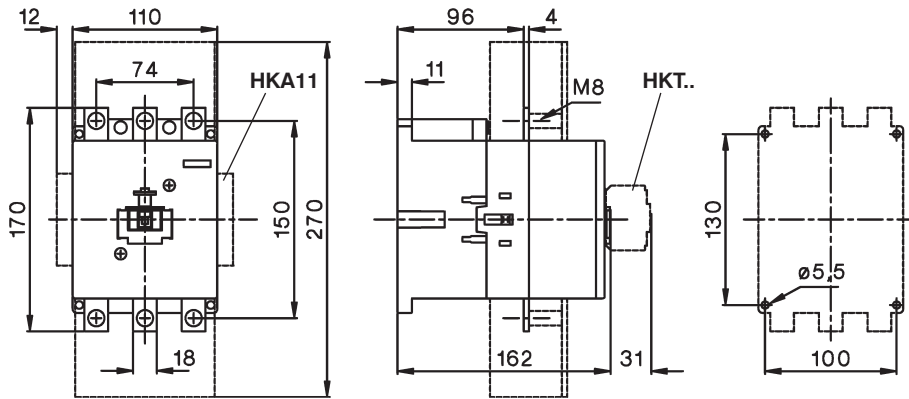

K3-210..
K3-260..
K3-316..

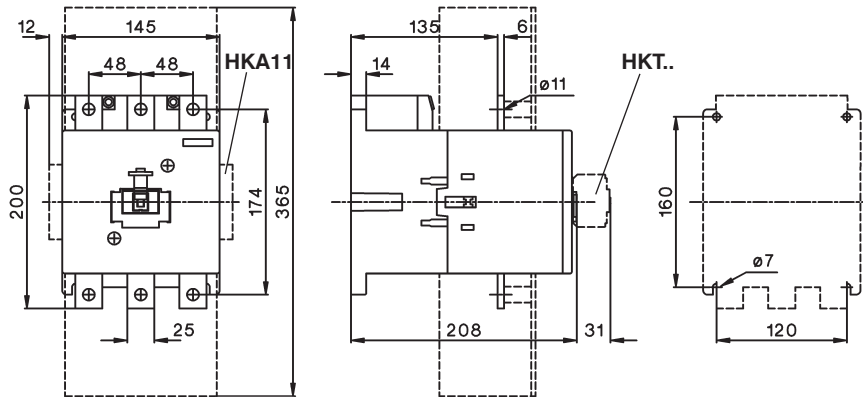

K3-450..
K3-550..

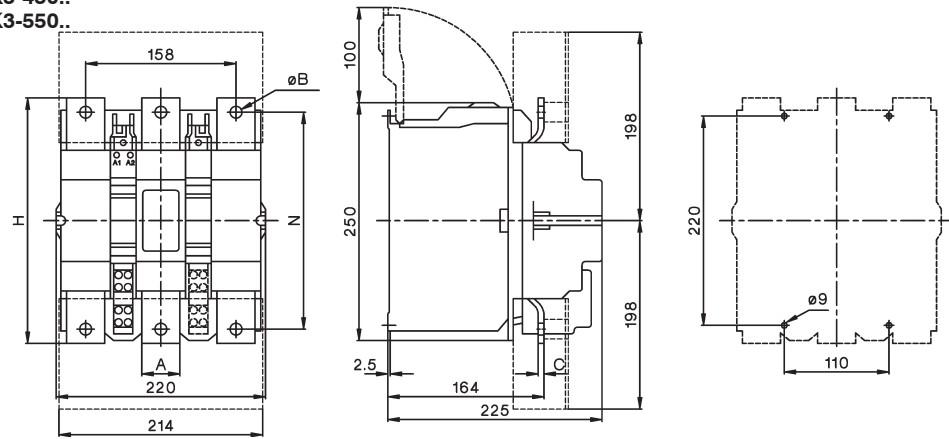

Typ	A	B	C	H	N
K3-450	40	10,5	4	233	206
K3-550	40	12,5	6	258	228

K3-700..
K3-860..

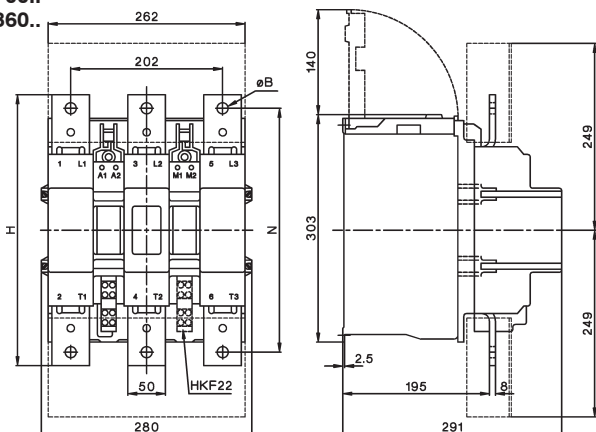

Typ	B	H	N
K3-700	13	310	277
K3-860	15	361	325

Leistungsschütze

Maße

wechsel- und gleichstrombetätigt

K3-1000..
K3-1200..

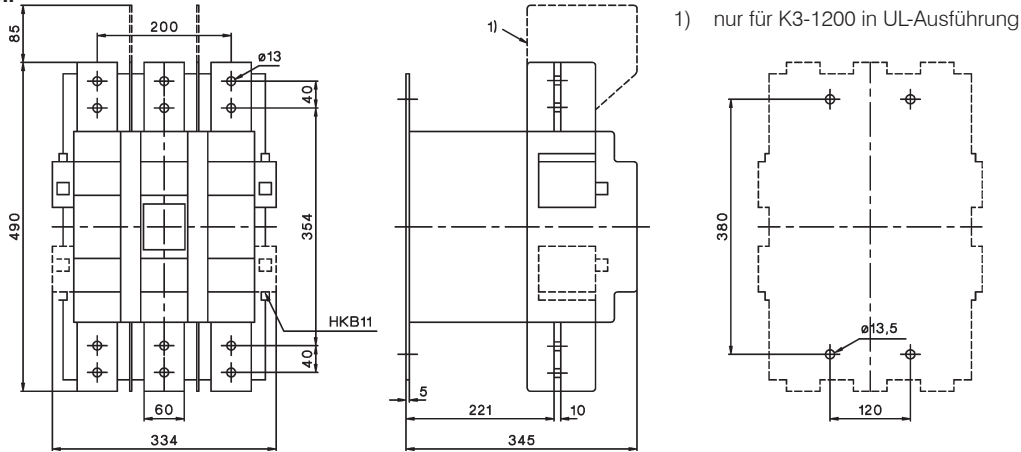

Kondensatorschütze, wechselstrombetätigt

K3-18NK..

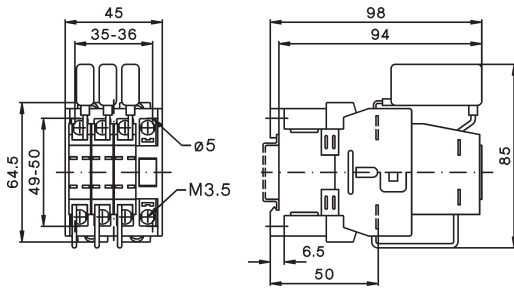

K3-18NBK..

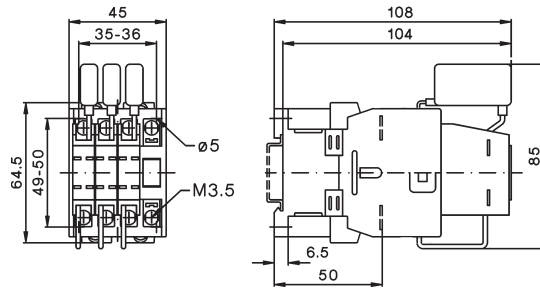

K3-24K..
K3-32K..

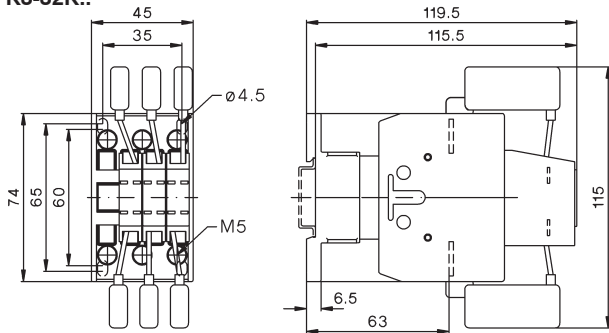

K3-50K..
K3-62K..
K3-74K..

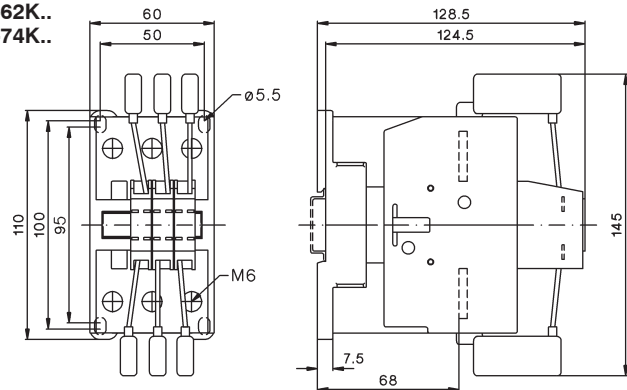

K3-90K..
K3-115K..

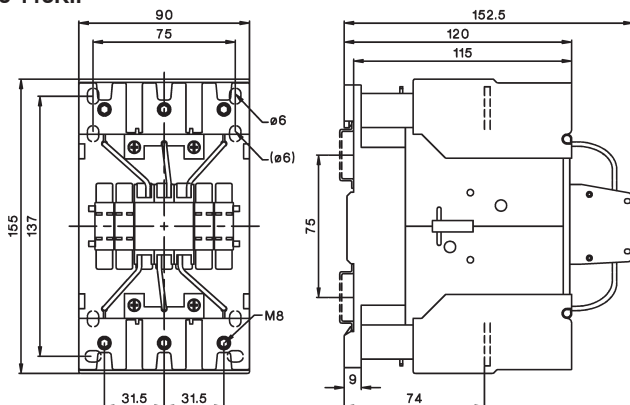

Leistungsschütze

Maße

Schütze 3-polig, gleichstrombetätigt

- K3-10N..=
- K3-14N..=
- K3-18N..=
- K3-22N..=

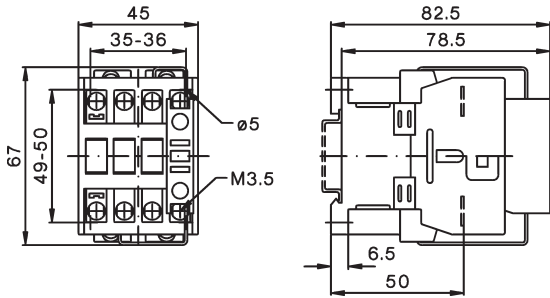

- K3-24..=
- K3-32..=
- K3-40..=

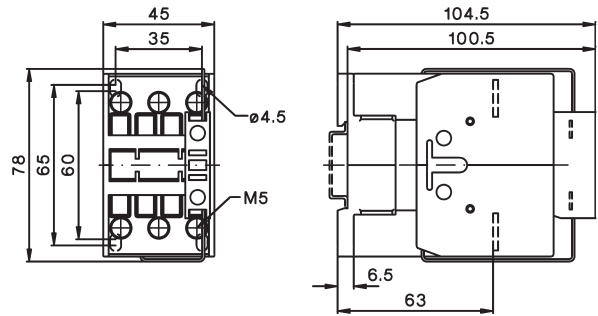

Schütze 4-polig, wechselstrombetätigt / gleichstrombetätigt

- K3-10NA00-40
- K3-14NA00-40
- K3-18NA00-40
- K3-22NA00-40

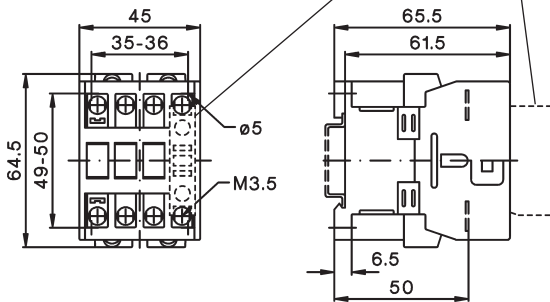

- K2-23A00-40
- K2-30A00-40
- K2-37A00-40

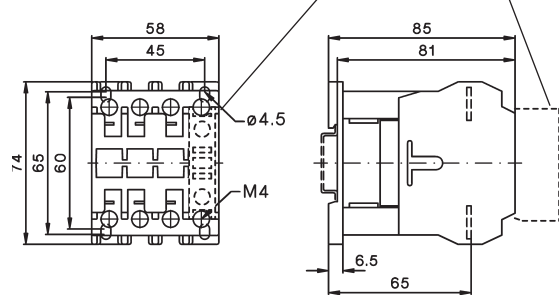

Schütze 4-polig, wechselstrombetätigt / gleichstrombetätigt

- K2-45A00-40
- K2-60A00-40

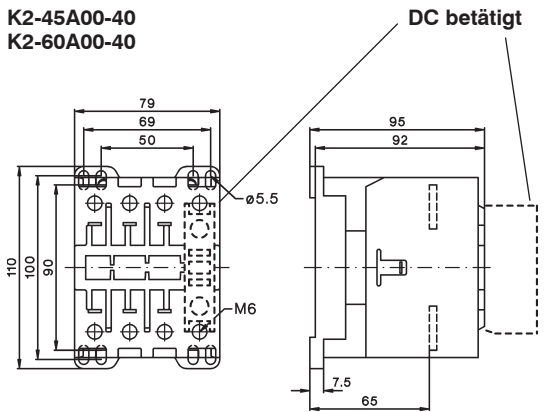

- K3-41A00-40

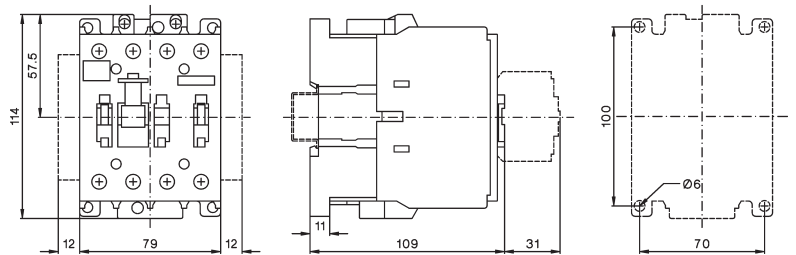

- K3-96A00-40

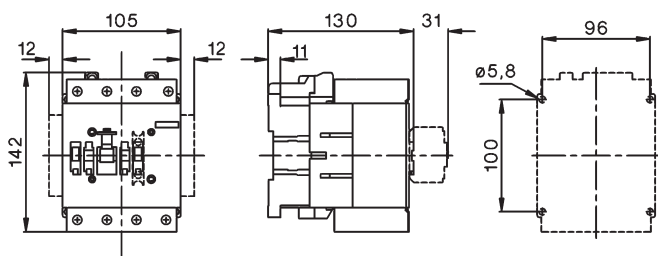

- K3-116A00-40
- K3-151A00-40
- K3-176A00-40

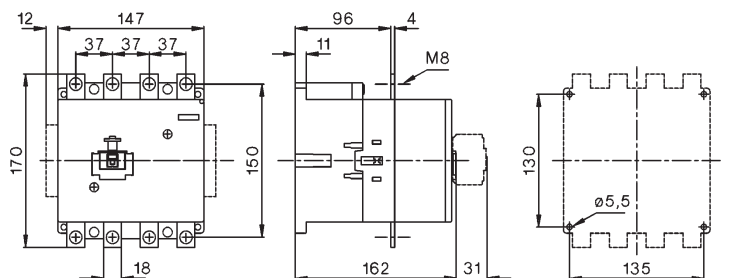

Leistungsschütze

Schütze 4-polig, wechsel- und gleichstrombetätigt

K3-210A00-40
K3-260A00-40
K3-316A00-40

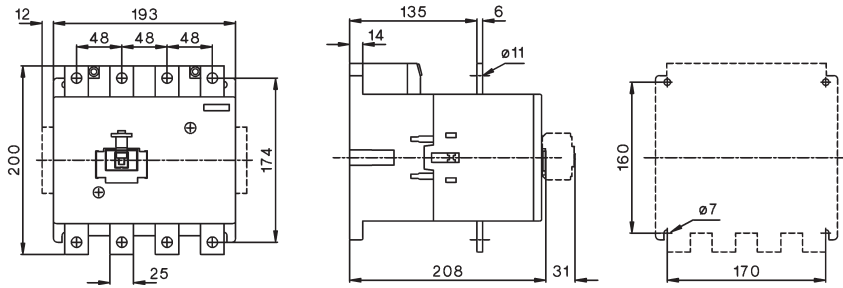

Maße Zubehör

Hilfskontakte Stützklappen
HN10, HN01 K2-SK, K2-DK

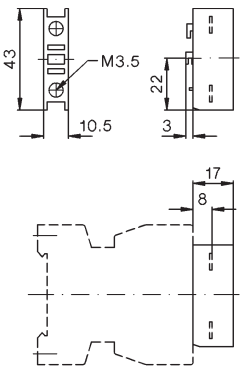

Tastkontakte
HTN10, HTN01

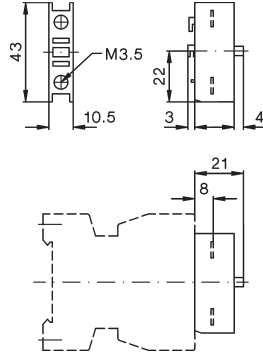

Hilfskontakte
HA10, HA01

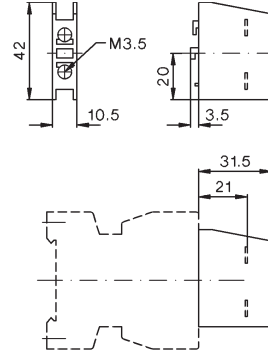

HB11, HB02

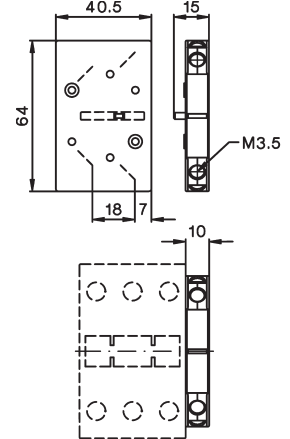

4. Pol für Schütze K3-200 bis K3-1200

Typ	A	B	C	D	E	F	G	H
NP175	223	148	26	52	98	5	122	M8
NP350	223	148	26	52	98	5	122	M8
NP325	262	148	26	55	116	5	122	M10
NP500	294	220	53	72	138	5	152	M12
NP760	294	220	53	72	138	5	152	M12
NP501	348	220	53	73	145	5	152	M12
NP1000	348	220	53	73	145	8	152	M12
NP1001	410	220	53	110	157	8	152	M12

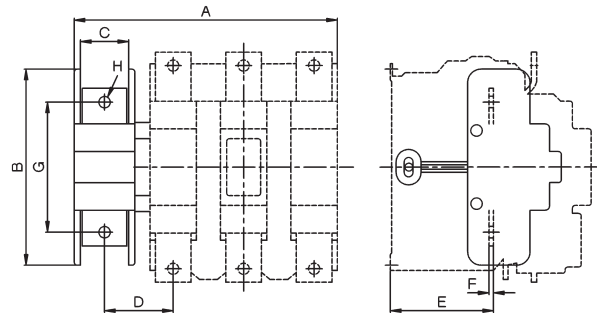

Elektronisches Zeitrelais

K3-T180 240

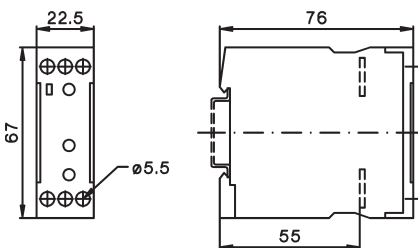

Elektronische Einschaltverzögerung

K2-TE..

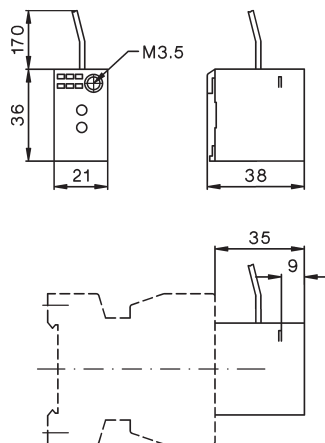

Leistungsschütze

Maße Zubehör

Mechanische Verriegelungen

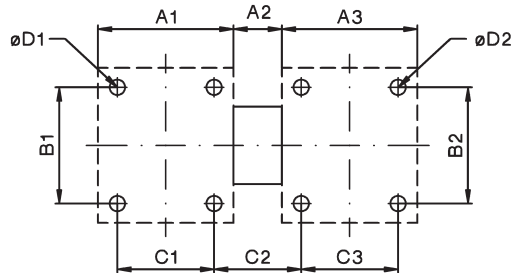

Typ	Schütz 1	Schütz 2	A1	A2	A3	B1	B2	C1	C2	C3	D1	D2	
LG10889	K3-07 bis K3-40	K3-07 bis K3-40	45	7	45	50	50	35	17	35	4,5	4,5	
LG10889	KG3-07 bis KG3-22	KG3-07 bis KG3-22	45	7	45	80	50	35	17	35	4,5	4,5	
LG10889	KG3-24 bis KG3-40	KG3-22 bis KG3-40	45	7	45	80	50	35	17	35	4,5	4,5	
LG10890	K3-50 bis K3-74	K3-24 bis K3-40	60	12	55	100	65	50	22	45	5,5	4,5	
LG10890	K3-50 bis K3-74	K3-50 bis K3-74	60	12	60	100	100	50	22	50	5,5	5,5	
LG11478	K3-90 bis K3-115	K3-90 bis K3-115	90	12	90	100	100	75	27	75	5,5	5,5	
LG8511	K65 - K110	K65 - K110	90	12	90	100	100	75	27	75	6	6	
LG11223H	K3-151, -176	K3-151, -176	110	30	110	130	130	100	40	100	6	6	3--polige Schütze
LG11223H	K3-116, -151, -176	K3-116, -151, -176	147	30	147	130	130	135	42	135	6	6	4--polige Schütze
LG11223H	K3-210, -260, -316	K3-210, -260, -316	145	30	145	160	160	120	55	120	6	6	3--polige Schütze
LG11223H	K3-210, -260, -316	K3-210, -260, -316	193	30	193	160	160	170	55	170	6	6	4--polige Schütze
LG10400H	K3-450, K3-550	K3-450, K3-550	220	42	220	220	220	110	152	110	9	9	
LG10402H	K3-700, -860	K3-700, -860	280	32	280	280	280	175	137	175	11	11	
LG10403H	K3-1000, -1200	K3-1000, -1200	334	46	334	380	380	120	260	120	13,5	13,5	
LG10399H	K3-450, -550	K3-700, -860	220	37	280	220	280	110	144,5	175	9	11	
LG10401H	K3-700, -860	K3-1000, -1200	280	73	334	280	380	175	232,5	120	11	13,5	

LG10400V, LG10402V

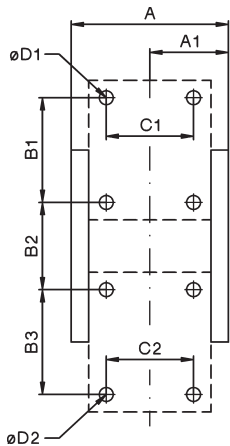

LG10399V

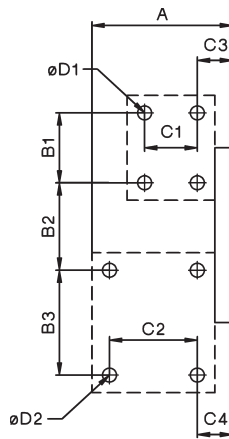

LG10403V, LG10401V

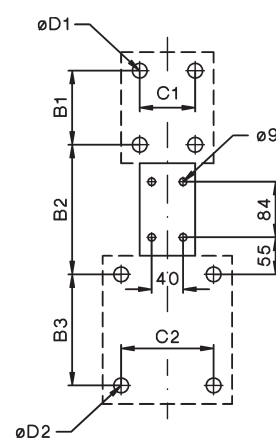

Typ	Schütz 1	Schütz 2	A	A1	B1	B2	B3	C1	C2	C3	C4	D1	D2
LG10400V	K3-315 - K3-550	K3-315 - K3-550	250	134	220	94	220	110	110	-	-	9	9
LG10402V	K3-700, -860	K3-700, -860	302	162	280	200	280	175	175	-	-	11	11
LG10403V	K3-1000, -1200	K3-1000, -1200	-	-	380	280	380	120	120	-	-	13,5	13,5
LG10399V	K3-450, -550	K3-700, -860	302	-	220	150	280	110	175	51	74,5	9	11
LG10401V	K3-700, -860	K3-1000, -1200	-	-	280	240	380	175	120	-	-	11	13,5

Leistungsschütze

Maße Zubehör

Mech. Verlinkung

K2-L..

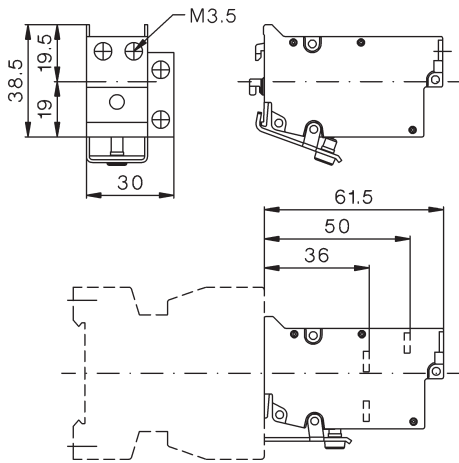

Schütze mit Zusatzklemmen

LG9339N (2 x 3 Stück)
für K3-10N. bis K3-22N.

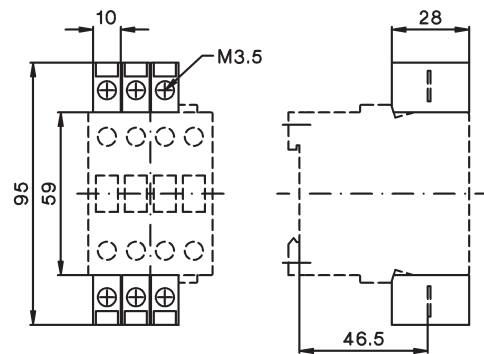

Anzeigeelemente

K2-ING, K2-INR
K2-UN, K2-UNR

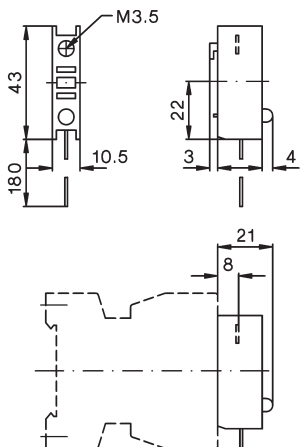

Sicherungshalter

K2-RF

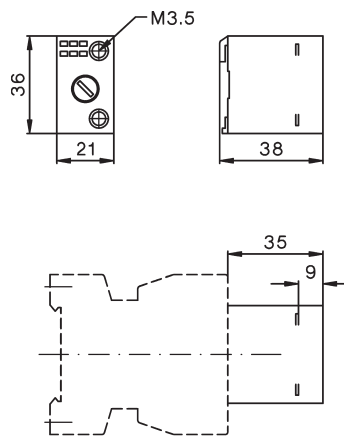

Sicherungshalter mit Gleichrichter

K2-RF1
K2-RF3

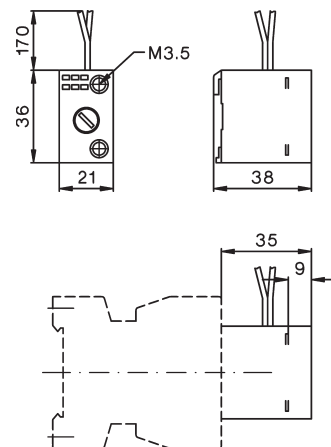

Leistungsschütze

Maße Zubehör

Interface

K2-IM

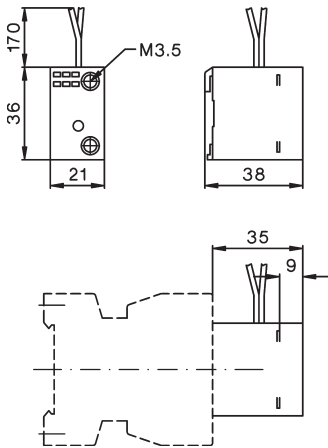

Schielenadapter

K2-SM

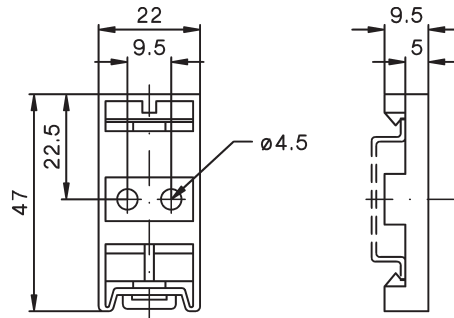

Entstörbauteile

RC-K3N ..

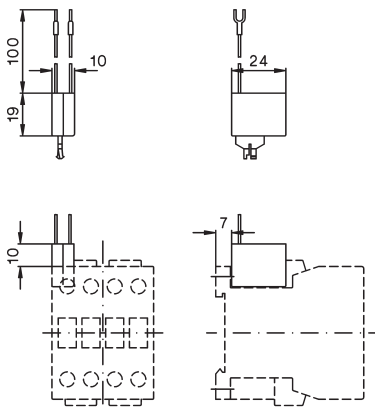

RC-K3NW ..

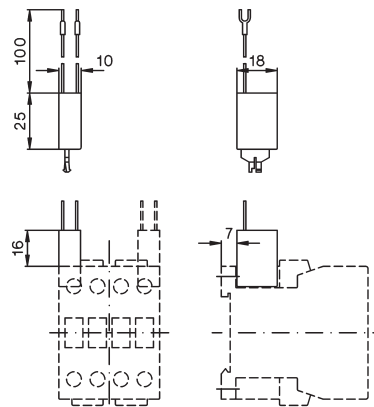

Bezeichnungsmaterial

Bezeichnungsschild
P487-1 oder **P245-**

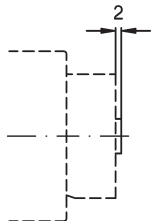

Leistungsschütze

Lage der Anschlußklemmen

K3-10ND10
K3-14ND10
K3-18ND10
K3-22ND10
K3-18NK10

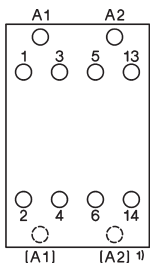

K3-10ND01
K3-14ND01
K3-18ND01
K3-22ND01
K3-18NK01

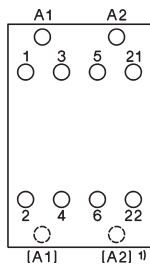

K3-24A00, K3-24K00
K3-32A00, K3-32K00
K3-40A00

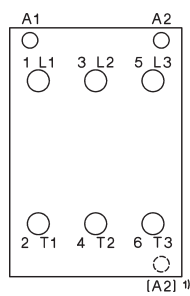

K3-50A00, K3-50K00
K3-62A00, K3-62K00
K3-74A00, K3-74K00

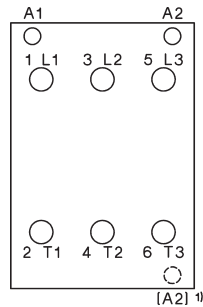

K3-10NA00-40
K3-14NA00-40
K3-18NA00-40
K3-22NA00-40
K2-23A00-40 bis
K2-60A00-40

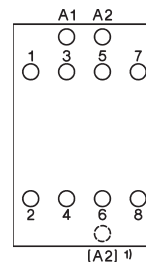

K85A22
K110A22

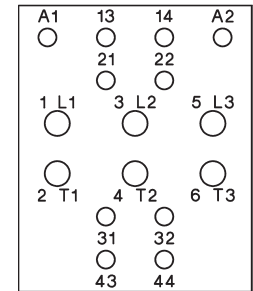

K3-90A00
K3-115A00

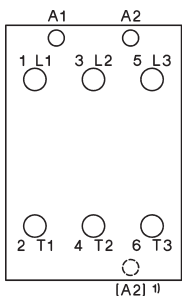

K3-151A00
K3-176A00
K3-210A00
K3-260A00
K3-316A00

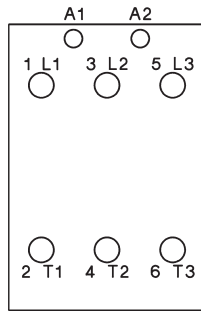

K3-116A00-40
K3-151A00-40
K3-176A00-40
K3-210A00-40
K3-260A00-40
K3-316A00-40

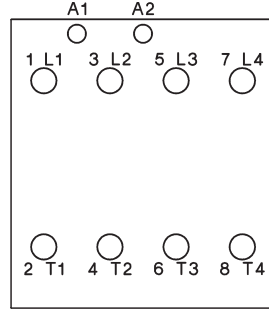

K3-450A22
K3-550A22
K3-700A22
K3-860A22

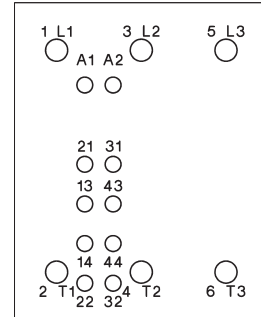

K3-1000A12
K3-1200A12

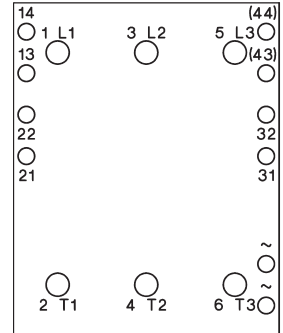

KG3-10A10
KG3-14A10
KG3-18A10
KG3-22A10

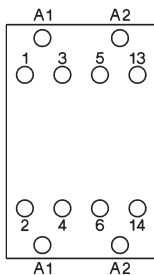

KG3-10A01
KG3-14A01
KG3-18A01
KG3-22A01

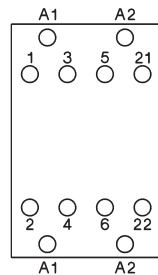

KG3-10A00-40
KG3-14A00-40
KG3-18A00-40
KG3-22A00-40

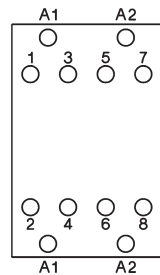

KG3-24A00
KG3-32A00
KG3-40A00

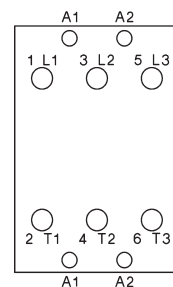

K3-10ND10=
K3-14ND10=
K3-18ND10=
K3-22ND10=

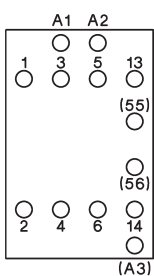

K3-10ND01=
K3-14ND01=
K3-18ND01=
K3-22ND01=

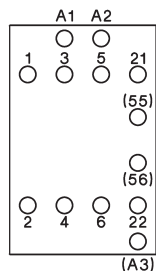

K3-24A00=
K3-32A00=
K3-40A00=

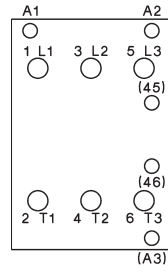

K3-50A00=
K3-62A00=
K3-74A00=

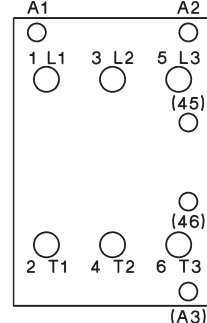

K85A21=
K110A21=

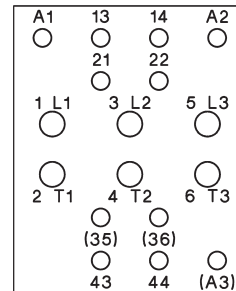

K3-1000A12=
K3-1200A12=

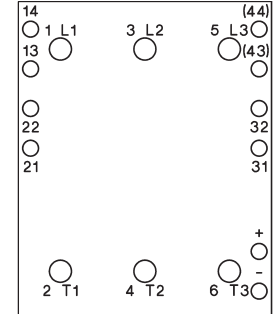

1) Typenzusatz "EUR" mit zusätzlichem Spulenanschluß
Bestellbeispiel - K3-10ND10EUR 230



Star-Delta Starters Open Type 92



Star-Delta Starters Enclosed Enclosure for Star-Delta Starters 94



Accessories 95



Reversing Contactors 96



Pole Changing Starters 98



Technical Data 100

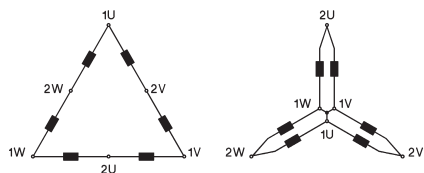

Wiring Diagrams 103

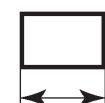

Dimensions 107

Star-Delta Starters Open Type

AC Operated



Ratings		Rated Current		order separately	Type	Coil voltage ¹⁾	Pack pcs.	Weight kg/pc.
AC3						220-240V 50Hz		
380V						380-415V 50Hz		
400V	660V	AC3		Overload Relay				
415V	500V	690V	400V					
kW	kW	kW	A	Type				
7,5	7,5	11	16	U3/32 U12/16E K3	K3NY15 ...		1	0,9
15	18,5	15	30		K3NY26 ...		1	0,9
22	30	22	45	U3/42	K3Y40 ...		1	1,4
30	37	30	60		K3Y52 ...		1	1,8
45	55	45	85	U3/74	K3Y80 ...		1	3,5
55	75	55	109		K3Y100 ...		1	3,7
75	90	90	150	U85	K3Y140 ...		1	6,6
110	132	110	205		K3Y200 ...		1	7
132	160	160	240	U180	K3Y240 ...		1	15
160	180	180	300		K3Y300 ...		1	15

Star-delta starters are wired to accept thermal overload relay. The thermal overload relay has to be ordered separately. For full load current setting use the YD-dial of thermal overload relay.

Ordering Example: Star-Delta Starter, open type, rated AC3 at 400V 205A rated control voltage 230V 50Hz - **Order Type: K3Y200 230 + U85 120**

Thermal Overload Relays

Rated Motor Current A	Type	Pack pcs.	Weight kg/pc.	Wiring Diagram
--------------------------	------	-----------	---------------	----------------

For Star-Delta Starters K3NY15.. to K3Y40..



7 - 10,5	U12/16E 6 K3	1	0,10	
10,5 - 15,5	U12/16E 9 K3	1	0,10	
14 - 19	U12/16E 11 K3	1	0,10	
18 - 24	U12/16E 14 K3	1	0,10	
23 - 31	U12/16E 18 K3	1	0,10	

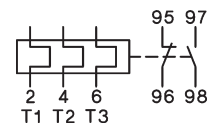

manual reset

For Star-Delta Starters K3NY15.. to K3Y52..



7 - 10,5	U3/32 6	1	0,14	
10,5 - 15,5	U3/32 9	1	0,14	
14 - 19	U3/32 11	1	0,14	
18 - 24	U3/32 14	1	0,14	
23 - 31	U3/32 18	1	0,14	
30 - 41	U3/32 24	1	0,14	
40 - 55	U3/32 32	1	0,14	

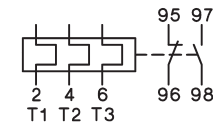

manual and auto reset

For Star-Delta Starters K3Y40.., K3Y52..



24 - 35	U3/42 20	1	0,30	
35 - 48	U3/42 28	1	0,30	
48 - 73	U3/42 42	1	0,30	

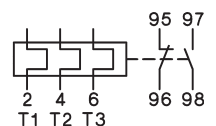

manual and auto reset

1) Coil voltage range and other coil voltages see page 100

Line Contactor	Delta Contactor	Star Contactor	Electronic Timer	Mechanical Interlock between K2 and K3	Star-Delta Starter Connector Type	Auxiliary Contacts Built-in for use on Contactor			Free Space for Aux. Contact Blocks on Contactor		
						Line K1	Delta K2	Star K3	Line K1	Delta K2	Star K3
K3-10ND01 + HN10	K3-10ND01	K3-10ND10 + HN10 + HN01	Y9A	LG10889	K3NY-VB10	-	-	-	3	4	2
K3-18ND01 + HN10	K3-18ND01	K3-14ND10 + HN10 + HN01	Y9A	LG10889	K3NY-VB10	-	-	-	3	4	2
K3-24A00 + HN10 + HN01	K3-24A00 + HN01	K3-24A00 + 2HN10 + HN01	Y9A	LG10889	K3Y-VB24	-	-	-	2	3	1
K3-32A00 + HN10 + HN01	K3-32A00 + HN01	K3-24A00 + 2HN10 + HN01	Y9A	LG10889	K3Y-VB24	-	-	-	2	3	1
K3-50A00 + HN01 + HN10	K3-50A00 + HN01	K3-32A00 + 2HN10 + HN01	Y9A	LG10890	-	-	-	-	2	3	1
K3-62A00 + HN01 + HN10	K3-62A00 + HN01	K3-50A00 + 2HN10 + HN01	Y9A	LG10890	-	-	-	-	2	3	1
K3-90A00 + HN01 + HN10	K3-90A00 + HN01	K3-90A00 + 2HN10 + HN01	Y9AL	LG11478	-	-	-	-	5	6	4
K3-115A00 + HN01 + HN10	K3-115A00 + HN01	K3-90A00 + 2HN10 + HN01	Y9AL	LG11478	-	-	-	-	5	6	4
K3-151A00 + HKT11	K3-151A00 + HKT11	K3-151A00 + HKT22	Y9AL	LG11223H	-	-	1/-	-/1	2	1	1
K3-176A00 + HKT11	K3-176A00 + HKT11	K3-151A00 + HKT22	Y9AL	LG11223H	-	-	1/-	-/1	2	1	1



Applications

The star-delta starting method is only practicable in such cases where the motor windings are connected in delta configuration for normal operation and the torque which is needed during the starting period is not higher than approx. 30% of the rated torque. The starting current drawn from the line will be approx. 2 to 2,7 times the rated motor current.

Time setting

The transition from start (star configuration) to normal operation (delta configuration) should be after the motor achieves practically full rotational speed. The use of star-delta timer Y9A with a dwell period of approx. 25ms provides a careful operation of motor and drive equipment.

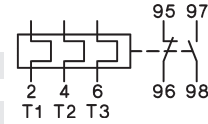
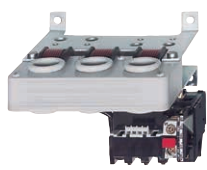
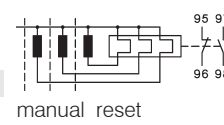
Thermal Overload Relays

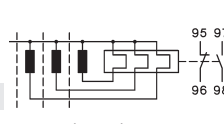
	Rated Motor Current A	Type	Pack pcs.	Weight kg/pc.	Wiring Diagram
	For Star-Delta Starters K3Y80.., K3Y100..				
	35 - 48	U3/74 28	1	0,40	
	48 - 73	U3/74 42	1	0,40	
	70 - 90	U3/74 52	1	0,40	
	90 - 112	U3/74 65	1	0,40	manual and auto reset
	For Star-Delta Starters K3Y140.., K3Y200..				
	104 - 156	U85 90	1	0,90	
140 - 207	U85 120	1	0,90	manual reset	
	For Star-Delta Starters K3Y240.., K3Y300..				
208 - 312	U180 180	1	1,5		
					manual and auto reset

Star-Delta Starters Enclosed Type

AC Operated

Ratings		Rated Current	Optional Extras	Wired to accept Overload Relay	Type	Coil voltage ¹⁾	Pack pcs.	Weight kg/pc.
AC3						220-240V 50Hz		
380V					230	380-415V 50Hz		
400V	660V	AC3			400			
415V	500V	690V	400V		↓			
kW	kW	kW	A	Type				

Plastic Enclosed, protected to IP65



7,5	7,5	11	16	ST	U3/32	K3NY15P ...	1	1,8
15	18,5	15	30	ST		K3NY26P ...	1	1,8
22	30	22	45	ST, H	U3/42	K3Y40P ...	1	3,8
30	37	30	60	ST, H		K3Y52P ...	1	4,2
45	55	45	85	ST, H	U3/74	K3Y80P ...	1	5,9
55	75	55	109	ST, H		K3Y100P ...	1	8,7

Sheet Steel Enclosed, protected to IP54



7,5	7,5	11	16	ST, H	U3/32	K3NY15B ...	1	2,8
15	18,5	15	30	ST, H		K3NY26B ...	1	2,8
22	30	22	45	ST, H	U3/42	K3Y40B ...	1	4,8
30	37	30	60	ST, H		K3Y52B ...	1	5,2
45	55	45	85	ST, H	U3/74	K3Y80B ...	1	15
55	75	55	109	ST, H		K3Y100B ...	1	15
75	90	90	150	ST, H	U85	K3Y140B ...	1	22
110	132	110	205	ST, H		K3Y200B ...	1	22

1) Coil voltage range and other coil voltages see page 100

Type-suffix for optional extras

Start-Stop Push Buttons

.....T ...

Selector Switch

.....W ...

Typical wiring diagrams see page 103-106

Control Circuit Fuse <250V (1 piece)

.....ST ...

>250V (2 pieces)

.....ST ...

Run Hour Meter

.....H ...

Ordering Example: Star-Delta Starter, steel sheet enclosed, with selector switch and run hour meter rated AC3 at 400V 82A, rated control voltage 230V 50Hz - **Order Type: K3Y80BWH 230 + U3/74 52**

Enclosures for Star Delta Starter



for Starter	accept Overload Relay	Type	Pack pcs.	Weight kg/pc.
Plastic IP65				
K3NY15, K3NY26	U3/32	K3Y26P-G3	1	1,0
K3Y40, K3Y52	U3/42, U3/32	K3Y40/52P-G3	1	2,4
Sheet Steel IP54				
K3NY15, K3NY26	U3/32	K3Y26B-G3	1	3,4
K3Y40, K3Y52	U3/42, U3/32	K3Y40/52B-G3	1	3,4

Star-Delta Starter Connector



For Star-Delta Starter Types

	Type	Pack pcs.	Weight kg/pc.
K3NY15, K3NY26	K3NY-VB10	1	0,02
K3Y40, K3Y52	K3Y-VB24	1	0,03

Additional Terminals



For Star-Delta Starter Types
Line Conn. Motor Conn.
Line Contactor Overload Relay

Cable cross-section mm²

Type

Pack pcs. Weight kg/pc.

Single pole with Fingertouch Protection

K3NY15, K3NY26	U12/16	0,75 - 10 solid 0,75 - 6 flex.	LG9339	6	0,009
----------------	--------	-----------------------------------	---------------	---	-------

Three-pole with Fingertouch Protection

	U3/42	4 - 35 strand. 4 - 25 flex.	LG7559	1	0,052
--	-------	--------------------------------	---------------	---	-------

Electronic Timers for Star-Delta Starters¹⁾



Rated Control Voltage V	Time Range s	Delay Time ms	Rated Current AC15		Type	Pack pcs.	Weight kg/pc.
			230V A	400V A			
24 - 60V AC	1 - 20	20 - 25	6	4	Y9A 60	1	0,075
110 - 415V AC	1 - 20	20 - 25	6	4	Y9A 415	1	0,075
24 - 60V~	1 - 20	40 - 80	6	4	Y9AL 60	1	0,075
110 - 415V~	1 - 20	40 - 80	6	4	Y9AL 415	1	0,075

Time repeat accuracy	± 1%	Power consumption at	24V	0,2VA
Minimum interval between operations	2s		60V	5VA
Short circuit protection	4A gl (gG)		220-240V	2VA
			380-415V	7VA

1) not suitable for contactors K3-450 - K3-1200

Mounting Bar



Specification	Type	Pack pcs.	Weight kg/pc.
For screw mounting of electronic timer Y9..	LG7735	10	0,09

Star-Delta Starters in Special Versions

Starters for Longer Starting Time

For longer starting times the thermal overload relay is mounted on delta-contactor. The motor is not protected in Y-connection. The timer used for this starter-type is the type Y91A, time range is 10 to 60s. Principal wiring diagram see page 104.

Ordering Example: K3YL52 230

Starters with two Thermal Overload Relays on request

Basic circuit diagram see page 104

Reversing Contactors with Mechanical Interlock

AC Operated

Ratings		Rated Current	Vorbereitet für Einbau	Wired to accept Overload Relay page 120 Type	Type	Coil voltage ¹⁾	Pack pcs.	Weight kg/pc.
AC3						110V 50Hz		
380V					110	220-240V 50Hz		
400V		660V	AC3		230	380-415 50Hz		
415V	500V	690V	400V		400			
kW	kW	kW	A		↓			

Open Type

4	5,5	5,5	10	U3/32 U12/16E K3	K3NWU10 ...	1	0,6
7,5	10	7,5	18		K3NWU18 ...	1	0,6
11	15	15	24	U3/42	K3WU24 ...	1	1,2
15	18,5	18,5	32		K3WU32 ...	1	1,4
18,5	18,5	18,5	40		K3WU40	1	1,4
22	30	30	50	U3/74	K3WU50 ...	1	2,5
30	37	37	62		K3WU62 ...	1	2,5
37	45	45	74		K3WU74 ...	1	2,5



Sheet Steel Enclosed, protected to IP54

4	5,5	5,5	10	U3/32	K3NWU10B ...	1	3,9
7,5	10	7,5	18		K3NWU18B ...	1	4,1
11	15	15	24	U3/42	K3WU24B ...	1	4,5
15	18,5	18,5	32		K3WU32B ...	1	4,7
22	30	30	50	U3/74	K3WU50B ...	1	7,1
30	37	37	62		K3WU62B ...	1	7,1



Reversing Starter Connector



For Reversing Starter Types

	Type	Pack pcs.	Weight kg/pc.
K3NWU10, K3NWU18	K3NW-VB10	1	0,02
K3WU24, K3WU32	K3W-VB24	1	0,025

1) Other coil voltages see page 57

Components for Combinations		Mechanical Interlock	Reversing Starter Connector	Auxiliary Contacts Built-in for use on Contactor		Free Space for Aux. Contact Blocks on Contactor	
Left Hand Side Contactor	Right Hand Side Contactor			K1 NO/NC	K2 NO/NC	K1 HN.. or HA..	K2
K1 Type	K2 Type	Type	Type				
K3-10ND10 + HN01	K3-10ND10 + HN01	LG10889	K3NW-VB10	-	-	3	3
K3-18ND10 + HN01	K3-18ND10 + HN01	LG10889	K3NW-VB10	-	-	3	3
K3-24A00 + HN10 + HN01	K3-24A00 + HN10 + HN01	LG10889	K3W-VB24	-	-	2	2
K3-32A00 + HN10 + HN01	K3-32A00 + HN10 + HN01	LG10889	K3W-VB24	-	-	2	2
K3-40A00 + HN10 + HN01	K3-40A00 + HN10 + HN01	LG10889	K3W-VB24	-	-	2	2
K3-50A00 + HN10 + HN01	K3-50A00 + HN10 + HN01	LG10890	-	-	-	2	2
K3-62A00 + HN10 + HN01	K3-62A00 + HN10 + HN01	LG10890	-	-	-	2	2
K3-74A00 + HN10 + HN01	K3-74A00 + HN10 + HN01	LG10890	-	-	-	2	2
K3-10ND10 + HN01	K3-10ND10 + HN01	LG10889	K3NW-VB10	-	-	3	3
K3-18ND10 + HN01	K3-18ND10 + HN01	LG10889	K3NW-VB10	-	-	3	3
K3-24A00 + HN10 + HN01	K3-24A00 + HN10 + HN01	LG10889	K3W-VB24	-	-	2	2
K3-32A00 + HN10 + HN01	K3-32A00 + HN10 + HN01	LG10889	K3W-VB24	-	-	2	2
K3-50A00 + HN10 + HN01	K3-50A00 + HN10 + HN01	LG10890	-	-	-	2	2
K3-62A00 + HN10 + HN01	K3-62A00 + HN10 + HN01	LG10890	-	-	-	2	2

Contactor, Motor-Starter

Circuit Breakers

Manual Motor-Starters

Switches

AC-Main Switches

DC-Switch Disconnect

Push Buttons

Representatives, Suppliers

Pole Changing Starters

AC Operated

Ratings			Rated Current	Wired to accept Overload Relay page 120 Type	Type	Coil voltage ¹⁾ 220-240V 50Hz 380-415 50Hz	Pack pcs.	Weight kg/pc.
AC3	380V	400V						
415V	500V	660V	AC3					
kW	kW	kW	400V	A				

230
400
↓

Open Type



7,5	10	10	18	2 x U3/32 2 x U12/16E K3	K3NPU18 ...	1	1,0
11	15	15	24		K3NPU24 ...	1	1,5
15	18,5	18,5	32	2 x U3/32	K3PU32 ...	1	1,9
22	30	30	50	2 x U3/74	K3PU50 ...	1	3,9
30	37	37	62		K3PU62 ...	1	3,9

Sheet Steel Enclosed, protected to IP54



7,5	10	7,5	18	2x U3/32	K3NPU18B ...	1	1,0
11	15	15	24		K3NPU24B ...	1	1,5
15	18,5	18,5	32		K3PU32B ...	1	1,9

Ordering Example: Pole Changing Starter, open version, rated AC3 at 400V 28A and 15A, control voltage 230V 50Hz
Order Type: K3PU32 230 + U3/32 32 + U3/32 18

Pole Changing Starters for Star-Delta Operation on request

1) Other coil voltages see page 57

Components for Combinations		Star Contactor	Free Space for Aux. Contact Blocks on Contactor		
High Speed	Low Speed		High Speed K1 HN.. or HA..	Low Speed K2	Star K3
K1 Type	K2 Type	K3 Type			
K3-18ND01 + 2 x HN10	K3-18ND01 + HN10	K3-14ND10	2	3	4
K3-24A00 + HN01 + 2 x HN10	K3-24A00 + HN01 + HN10	K3-18ND10	1	2	4
K3-32A00 + HN01 + 2 x HN10	K3-32A00 + HN01 + HN10	K3-24A00 + HN10	1	2	3
K3-50A00 + HN01 + 2 x HN10	K3-50A00 + HN01 + HN10	K3-32A00 + HN10	1	2	3
K3-62A00 + HN01 + 2 x HN10	K3-62A00 + HN01 + HN10	K3-50A00 + HN10	1	2	3
K3-18ND01 + 2 x HN10	K3-18ND01 + HN10	K3-14ND10	2	3	4
K3-24A00 + HN01 + 2 x HN10	K3-24A00 + HN01 + HN10	K3-18ND10	1	2	4
K3-32A00 + HN01 + 2 x HN10	K3-32A00 + HN01 + HN10	K3-24A00 + HN10	1	2	3

Star-Delta Starters

Data according to IEC 947-4-1, VDE 0660, EN 60947-4-1

Type		K3NY15	K3NY26	K3Y40	K3Y52	K3Y80	K3Y100	K3Y140	K3Y200	K3Y240	K3Y300
Main Contacts											
Rated insulation voltage $U_i^{(1)}$	V AC	690	690	690	690	690	690	690	690	690	690
Frequency of operations z_{AC3, I_e}	1/h	15									
Change-over time max. (Y-step)	s	20 (Type K3YL ... 60)									
Utilization category AC3											
Switching of three-phase motors											
Rated operational current I_e	220-230V A	16	30	45	60	85	109	150	205	240	300
	240V A	16	30	45	60	85	109	150	205	240	300
	380-400V A	16	30	45	60	85	109	150	205	240	300
	415-440V A	15	30	45	60	85	109	150	205	240	300
	500V A	15	30	45	60	85	95	150	205	190	240
	660-690V A	13	17	30	36	57	72	103	118	147	180
Rated operational power of three-phase motors 50-60Hz	220-230V kW	4	7,5	11	15	22	30	45	55	75	90
	240V kW	5,5	11	15	18,5	22	30	45	55	75	90
	380-400V kW	7,5	15	22	30	45	55	75	110	132	160
	415-440V kW	7,5	15	22	30	45	55	75	110	140	170
	500V kW	7,5	18,5	30	37	55	75	90	132	132	180
	660-690V kW	11	15	22	30	45	55	90	110	132	180
Cable cross-sections											
Line	solid or stranded	mm ²	1,5 - 6 ²⁾		1,5 - 16		10 - 70 ³⁾		10 - 120		busbar
	flexible	mm ²	1,5 - 4 ²⁾		1,5 - 16		16 - 50 ³⁾		10 - 95		18x5
	flexible with multicore cable end	mm ²	1,5 - 4 ²⁾		1,5 - 16		10 - 35		10 - 95		M8
Motor	solid or stranded	mm ²	1,5 - 6		1,5 - 16		4 - 35 ³⁾		10 - 120		busbar
	flexible	mm ²	1,5 - 4		1,5 - 16		6 - 25 ³⁾		10 - 95		18x5
	flexible with multicore cable end	mm ²	1,5 - 4		1,5 - 16		4 - 25		10 - 95		M8
Power consumption of the combination											
inrush and change-over	VA	55		130		183		560		700	
	sealed VA	20		26		36		10		10	
	W	6		8		14		10		10	

Coil Voltage Ranges and Non Standard Voltages for Star-Delta Starters

K3NY15.. to K3Y100..

Suffix to Star-Delta Starter type e.g. K3Y80 400	Rated Control Voltage U_s range for 50Hz		range for 60Hz	
	min. V	max. V	min. V	max. V
24	24	24	24	27
42	42	47	47	52
110	100	110	110	122
180	180	210	200	240
230	220	240	230	264
400	380	415	400	415

K3Y140, to K3Y300..

Suffix to Star-Delta Starter type e.g. K3Y300 230	Rated Control Voltage U_s range for 50Hz		range for 60Hz		for DC
	min. V	max. V	min. V	max. V	V
24	24	24	24	24	24
48	48	48	48	48	48
110	110	120	110	120	110
230	220	240	220	240	220
400	380	415	380	415	-

Standard voltages in bold type letters

1) Suitable for: earthed-neutral systems, overvoltage category I to IV, pollution degree 3 (standard-industry): $U_{imp} = 8kV$. Data for other conditions on request.

2) Additional terminals see page 95

3) Maximum cable cross-section with prepared conductor

Reversing Starters

Data according to IEC 947-4-1, VDE 0660, EN 60947-4-1

Type		K3NWU10	K3NWU18	K3WU24	K3WU32	K3WU50	K3WU62	K3WU74
Main Contacts								
Rated insulation voltage $U_i^{1)}$	V AC	690	690	690	690	690	690	690
Utilization category AC3								
Switching of three-phase motors								
Rated operational current I_e	220V A	12	18	23	30	45	63	
	230V A	11,5	18	24	32	50	62	74
	240V A	11	18	24	32	50	62	74
	380-400V A	10	18	24	32	50	62	74
	415-440V A	9	18	23	30	50	62	74
	500V A	9	16	23	30	45	60	74
	660-690V A	6,5	8,5	17	20	31	40	40
Rated operational power of three-phase motors 50-60Hz	220-230V kW	3	5	6	8,5	12,5	18,5	
	240V kW	3	5	7	9	13,5	19	23
	380-400V kW	4	7,5	11	15	22	30	37
	415-440V kW	4,5	8,5	12	16	24	33	40
	500V kW	5,5	10	15	18,5	30	37	45
	660-690V kW	5,5	10	15	18,5	30	37	45
Cable cross-sections								
Line	solid or stranded mm ²	0,75 - 6		1,5 - 25		4 - 50		
	flexible mm ²	1 - 4		2,5 - 16		6 - 35		
	flexible with multicore cable end mm ²	0,75 - 4		1,5 - 16		6 - 35		
Cables per clamp		1		1		1		
Power consumption of the combination								
	inrush and change-over VA	33 - 45		90 - 115		140 - 185		
	sealed VA	7 - 10		9 - 13		13 - 18		
	W	2,6 - 3		2,7 - 4		5,4 - 7		

Technical Data according to UL508

Main Contacts (cULus)	Type	KNW3-10	KNW3-18	KW3-24	KW3-32	KW3-40
Rated operational power of three-phase motors at 60Hz (3ph)	110-120V hp	1½	2	5	5	7½
	200V hp	3	5	7½	10	10
	220-240V hp	3	7½	10	10	15
	277V hp	3	7½	7½	10	15
	380-415V hp	5	10	10	15	20
	440-480V hp	5	10	15	20	25
	550-600V hp	7½	15	20	25	30
Fuse / Short-circuit current	A/kA	30/5	50/5	90/5	125/5	175/5
Rated voltage	V	600	600	600	600	600
Auxiliary Contacts (cULus)		A600	A600	A600	A600	A600
Cable cross-sections						
for main connectors	solid AWG	18 - 10		16 - 10		
	flexible AWG	18 - 10		14 - 4		
Cables per clamp		1		1		

1) Suitable for: earthed-neutral systems, overvoltage category I to IV, pollution degree 3 (standard-industry); $U_{mp} = 8kV$. Data for other conditions on request.

Pole Changing Starters

Data according to IEC 947-4-1, VDE 0660, EN 60947-4-1

Type		K3NPU18	K3NPU24	K3PU32	K3PU50	K3PU62
Main Contacts						
Rated insulation voltage U_i ¹⁾	V AC	690	690	690	690	690
Utilization category AC3						
Switching of three-phase motors						
Rated operational current I_e	220V A	18	23	30	45	63
	230V A	17,5	23	30	45	60
	240V A	17	23	30	45	60
	380-400V A	16	23	30	45	60
	415V A	16	23	30	45	60
	440V A	16	23	30	45	60
	500V A	16	23	30	45	55
	660V A	9	17,5	21	33	42
	690V A	8,5	17	20	31	40
Rated operational power of three-phase motors 50-60Hz	220-230V kW	5	6	8,5	12,5	18,5
	240V kW	5	7	9	13,5	19
	380-400V kW	7,5	11	15	22	30
	415-440V kW	8,5	12	16	24	33
	500V kW	10	15	18,5	30	37
	660-690V kW	7,5	15	18,5	30	37
Cable cross-sections						
Line	solid or stranded mm ²	0,75 - 6	1,5 - 25		4 - 50	
	flexible mm ²	1 - 4	2,5 - 16		6 - 35	
	flexible with multicore cable end mm ²	0,75 - 4	1,5 - 16		6 - 35	
Cables per clamp		1	1		1	
Power consumption of the combination						
	inrush and change-over VA	55	128		178	
	sealed VA	20	26		31	
	W	6	8		11	

1) Suitable for: earthed-neutral systems, overvoltage category I to IV, pollution degree 3 (standard-industry): $U_{imp} = 8kV$. Data for other conditions on request.

Star-Delta Starters

Wiring Diagrams Main Circuit

Terminal markings of contactors and relays according to DIN EN 50012
Connections shown in main and circuits as broken lines are not included.

K3NY15 to K3Y100

with thermal overload relay U3/.. or U12/16

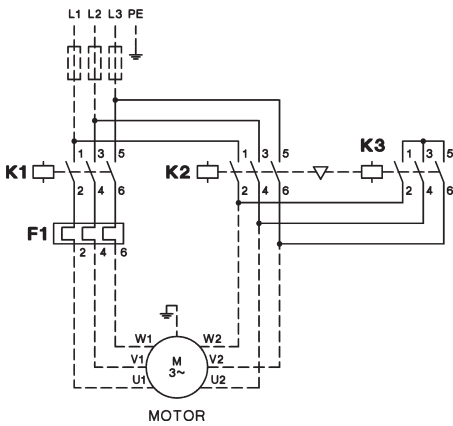

K3Y140 to K3Y300

with thermal overload relay U85 or U180

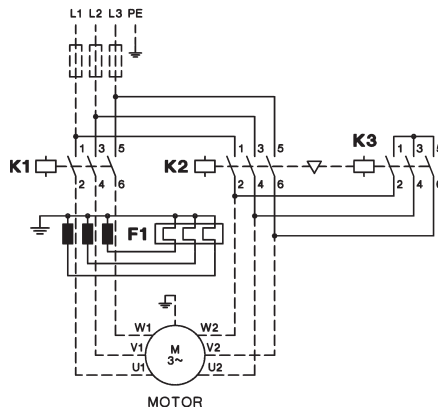

Wiring Diagrams Control Circuit

K3NY15 to K3Y52

operating with control switch

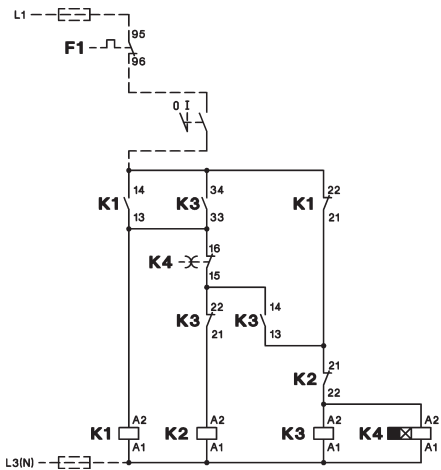

K3NY15 to K3Y52

operating with push buttons

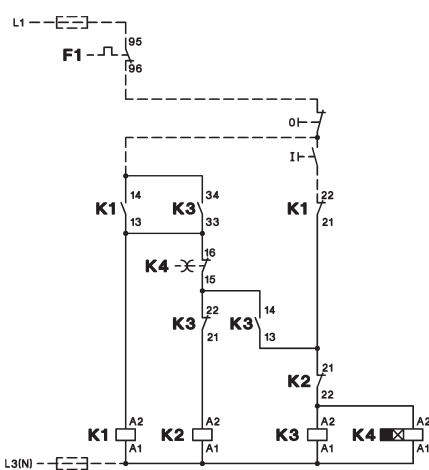

K3Y80 to K3Y200

operating with control switch

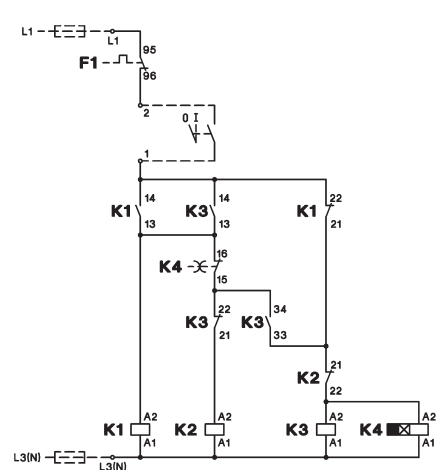

K3Y80 to K3Y200

operating with push buttons

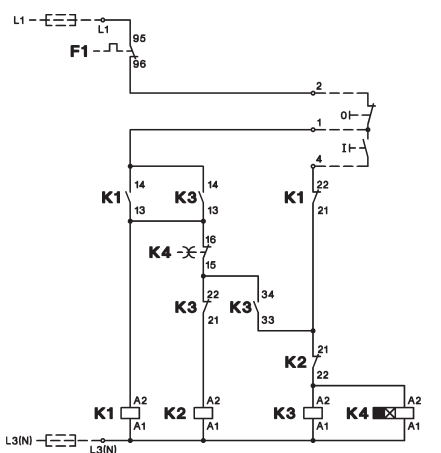

K3Y240 to K3Y300

operating with control switch

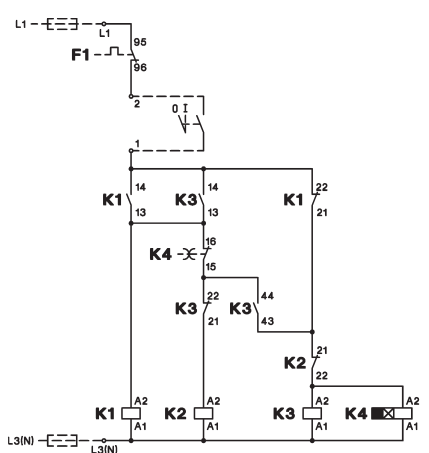

K3Y240 to K3Y300

operating with push buttons

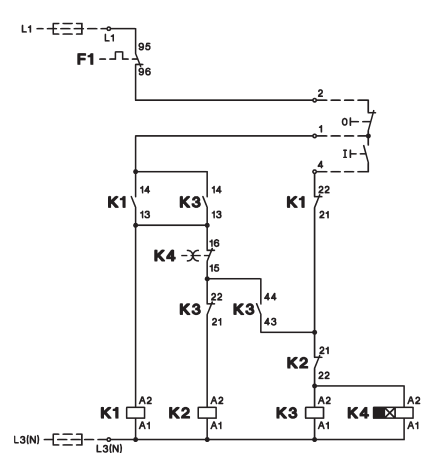

Star-Delta Starters

Wiring Diagrams Main Circuit

Terminal markings of contactors and relays according to DIN EN 50012
 Connections shown in main and control circuits as broken lines are not included.

K3YL..

Typical circuit diagram

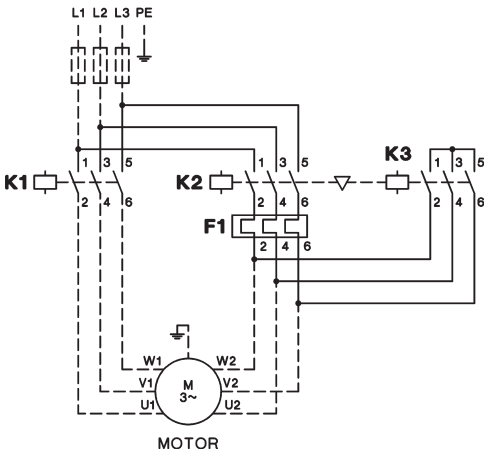

K3Y.. with 2 Thermal Overload Relays

Typical circuit diagram

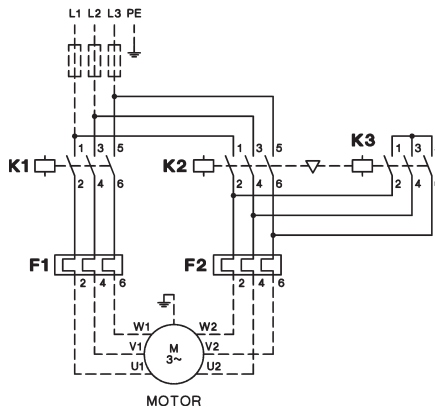

Wiring Diagrams Control Circuit

with selector switch

K3Y..W

Typical circuit diagram
 operating with control switch

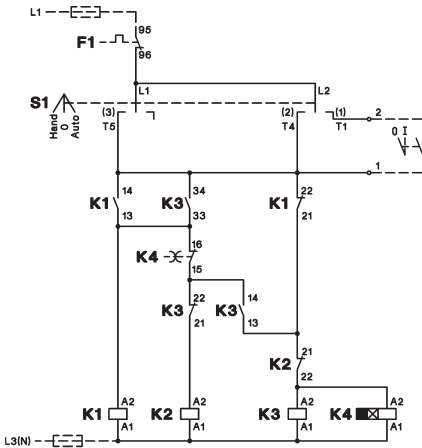

Typical circuit diagram
 operating with push buttons

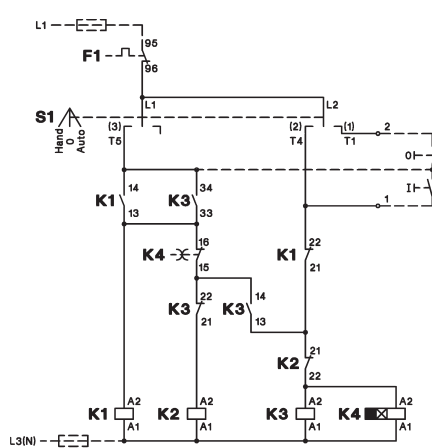

with push buttons

K3Y..T

Typical circuit diagram

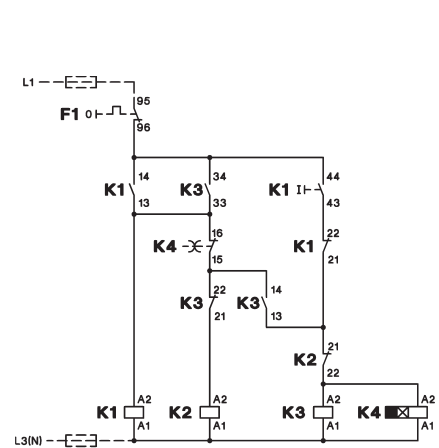

Reversing Contactors

Wiring Diagrams Main Circuit

Terminal markings of contactors and relays according to DIN EN 50012
 Connections shown in main and control circuits as broken lines are not included.

K3NWU10 to K3WU74

with thermal overload relay U3/32, U3/42 or U3/74

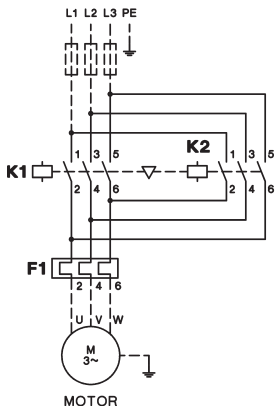

Wiring Diagrams Control Circuit

K3NWU10 to K3WU32

operating with control switch

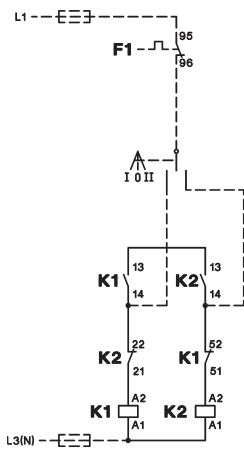

operating with push buttons
Reversing over off-position

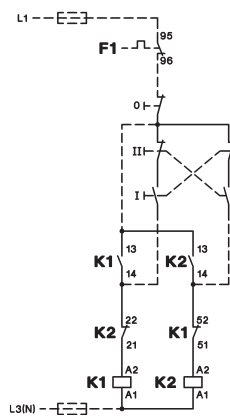

Reversing direct

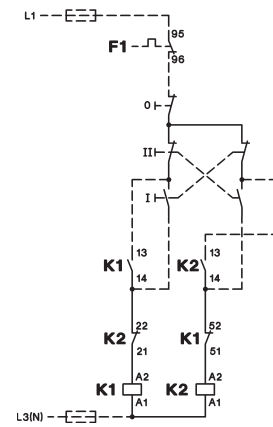

K3WU50, K3WU62, K3WU74

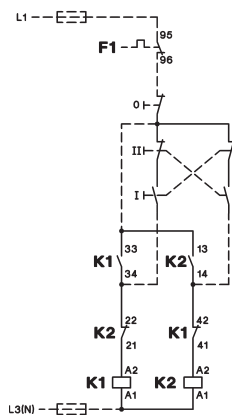
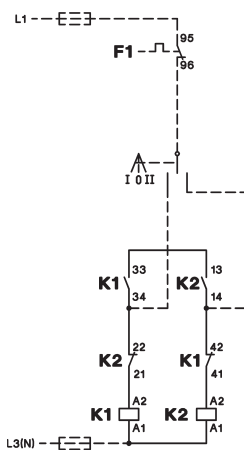

Pole Changing Starters

Wiring Diagrams

Terminal markings of contactors and relays according to DIN EN 50012
 Connections shown in main and control circuits as broken lines are not included.

Main Circuit

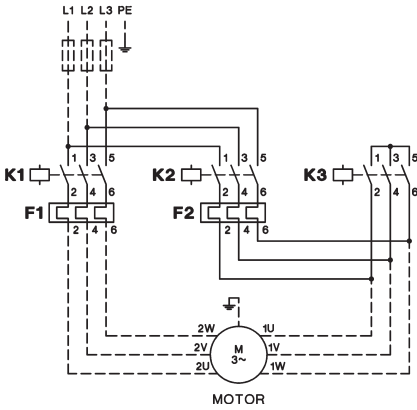

Principal Control Circuit Wiring Diagram

operating with control switch

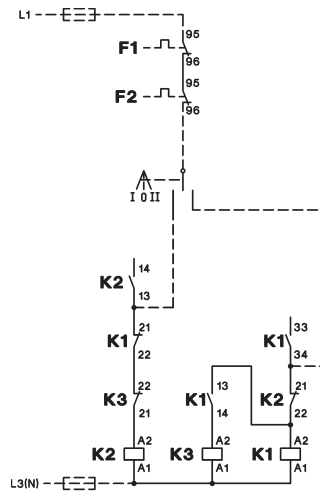

operating with push buttons

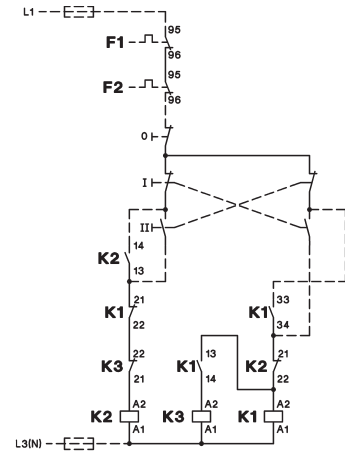

	Low speed	High speed	Low speed	High speed
Operation	Delta	Double-Star	Star	Double-Star
Speed relation	1	2	1	2
Power relation	1	1,5 - 1,8	0,3	1

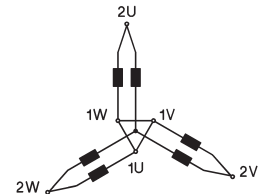
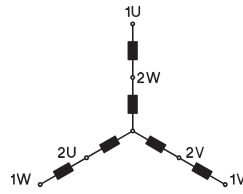
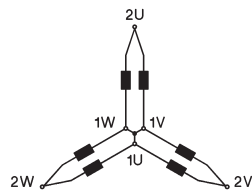
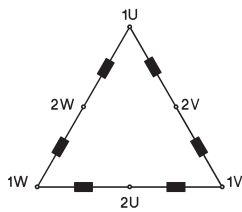

Star-Delta Starters

Dimensions

Star-Delta Starters, AC operated, open type

K3NY15 + U3/32
K3NY26

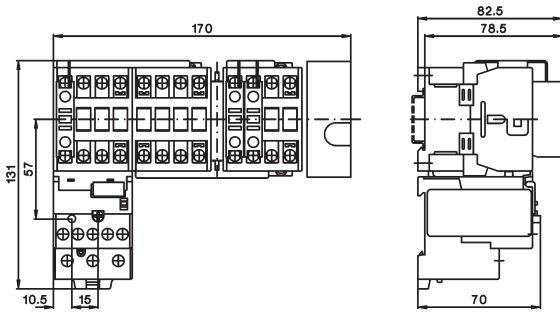

K3NY15 + U12/16E G3
K3NY26

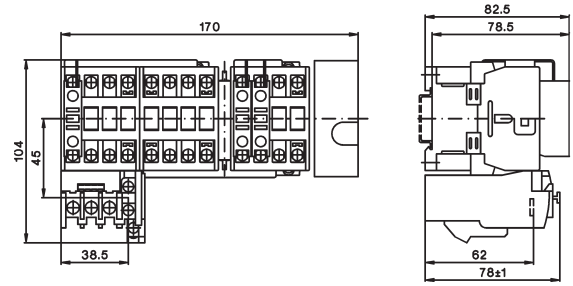

K3Y40 + U3/32
K3Y52 + U3/32

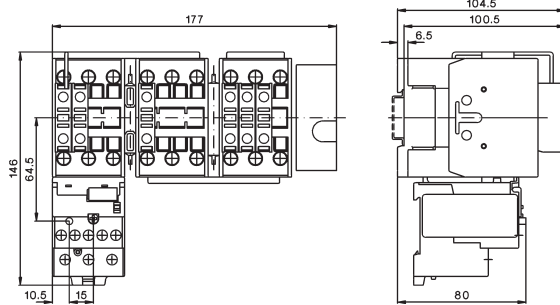

K3Y40 + U3/42
K3Y52 + U3/42

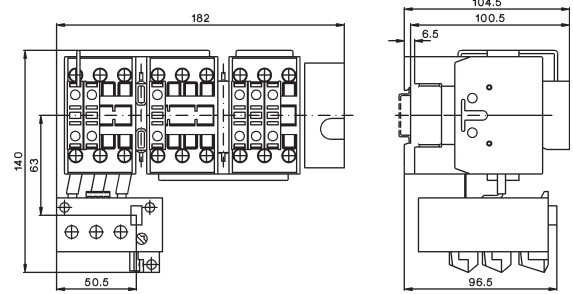

K3Y80 + U3/74

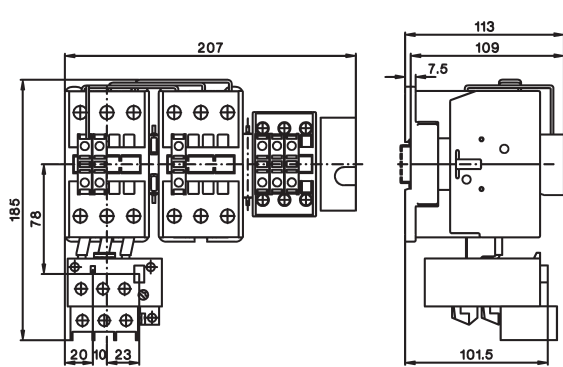

K3Y100 + U3/74

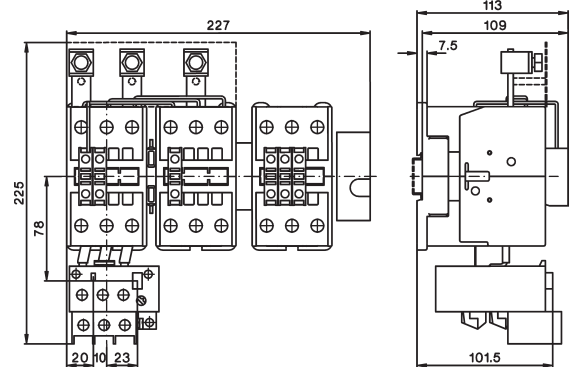

K3Y140 + U85
K3Y200

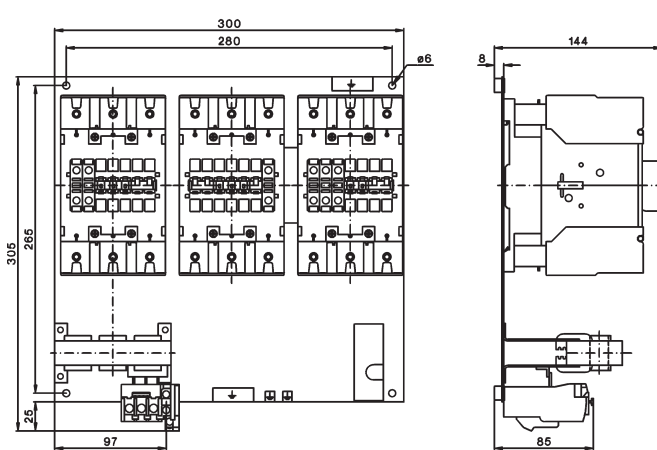

K3Y240 + U180 + SU180/176
K3Y300

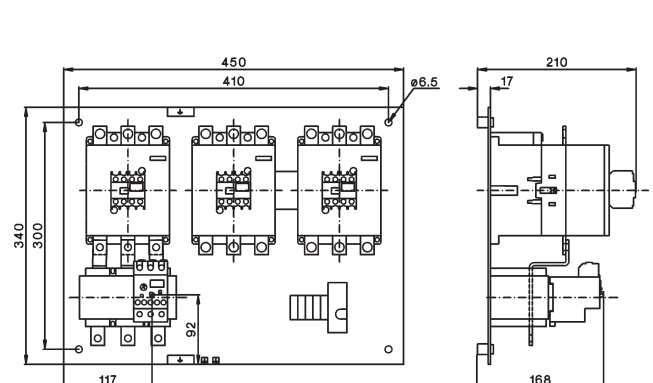

Star-Delta Starters

Dimensions

Star-Delta Starters, plastic enclosed, protected to IP65

K3NY26P

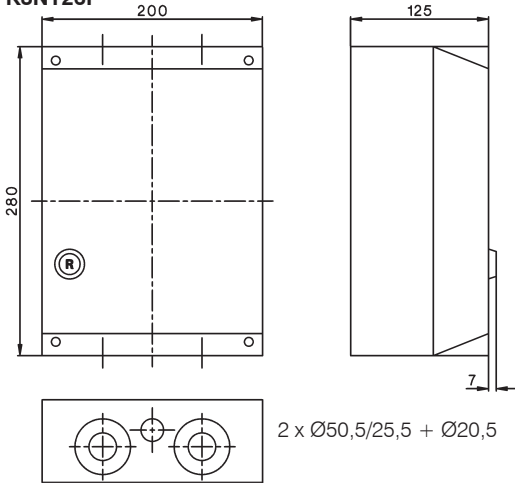

K3Y40P to K2Y100P

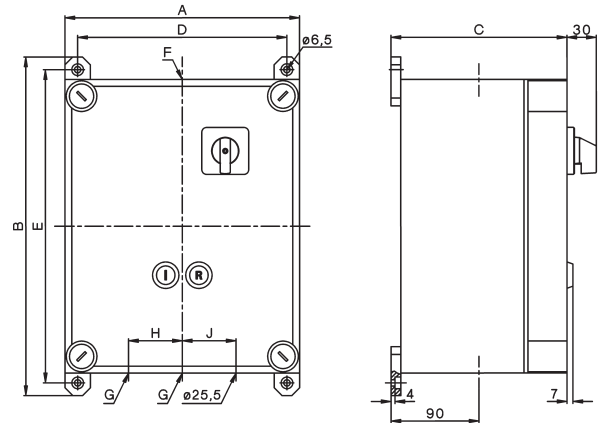

Type	A	B	C	D	E	Ø F	Ø G	H	J	
K3Y40P	300	346	180	272	320	6,5	32,5	32,5	60	60
K3Y52P	300	346	180	272	320	6,5	32,5	32,5	60	60
K3Y80P	300	446	180	272	420	6,5	40,5	40,5	70	70
K3Y100P	300	446	180	272	420	6,5	50,5	40,5	70	70

Star-Delta Starters, sheet steel enclosed, protected to IP54

K3Y26B to K3Y52B

Type	Ø F	Ø G
K3NY26B	25,5	25,5
K3Y40B	32,5	32,5
K3Y52B	32,5	32,5

Mounting by included fixing link

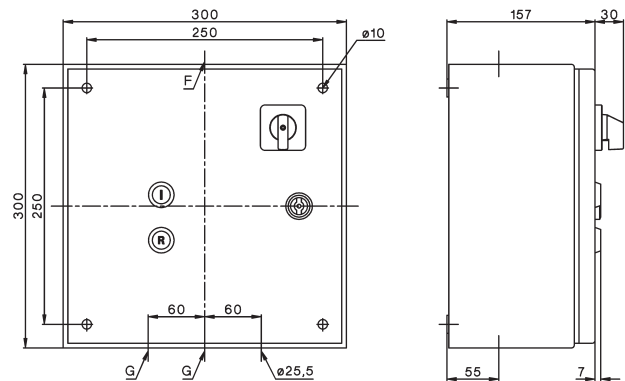
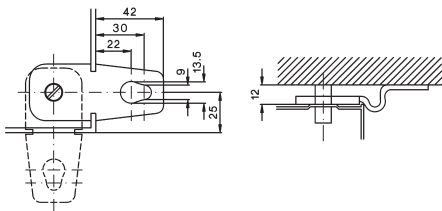

K3Y80B to K2Y200B

Type	A	B	C	D	E	L	M
K3Y80B	380	380	210	340	340	8,7	65
K3Y100B	380	380	210	340	340	8,7	65
K3Y140B	380	600	210	560	340	8,7	65
K3Y200B	380	600	210	560	340	8,7	65

Type	Ø F	Ø G	H	J	K
K3Y80B	40,5	40,5	70	70	60
K3Y100B	50,5	40,5	80	70	60
K3Y140B	50,5	50,5	80	80	70
K3Y200B	50,5	50,5	80	80	70

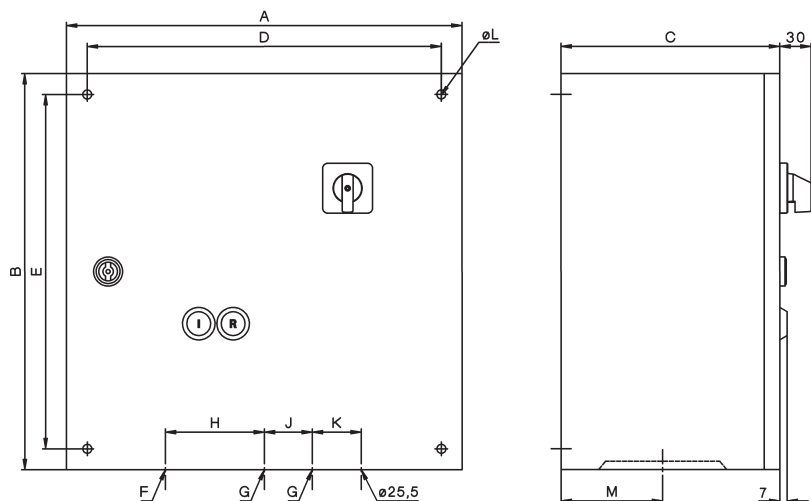

Reversing Contactors

Dimensions

Reversing Starters, AC operated, open type

K3NWU10 + U3/32
K3NWU18

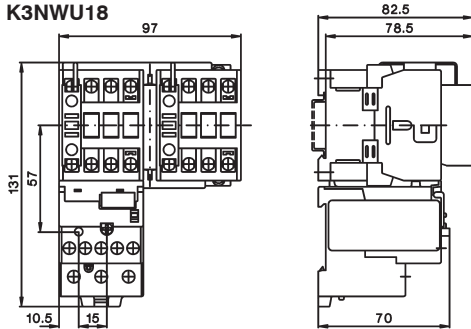

K3NWU10 + U12/16E G3
K3NWU18

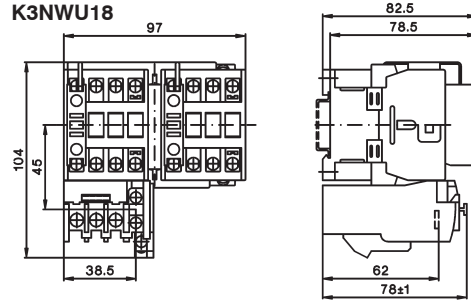

K3WU24 + U3/32
K3WU32
K3WU40

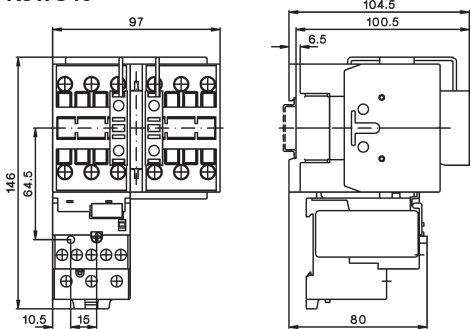

K3WU24 + U3/42
K3WU32
K3WU40

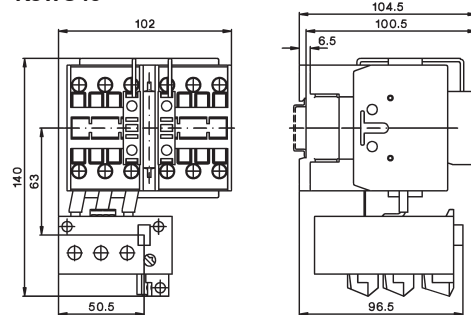

K3WU50 + U3/74
K3WU62
K3WU74

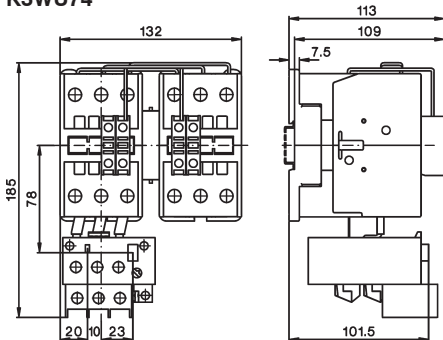

Reversing Contactors, sheet steel enclosed, protected to IP54

Type	A	B	C	D	E	F	G	H	K
K3NWU18B	300	300	150	250	250	30	30	Ø25,5	41
K3WU24B	300	300	150	250	250	30	30	Ø32,5	41
K3WU32B	300	300	150	250	250	30	30	Ø32,5	41
K3WU50B	300	300	150	250	250	40	40	Ø32,5	59
K3WU62B	300	300	150	250	250	40	40	Ø32,5	59

Mounting by included fixing link

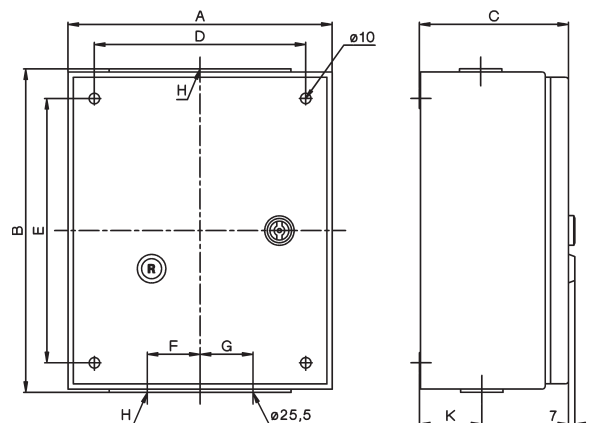
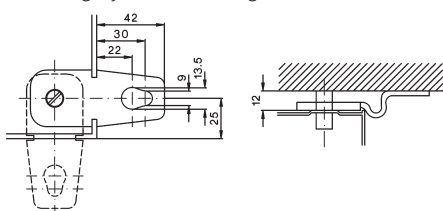

Pole Changing Starters

Dimensions

Pole Changing Starters, AC operated, open type

K3NPU18 + 2x U3/32

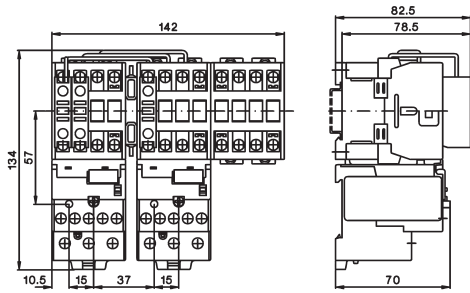

K3NPU18 + 2x U12/16

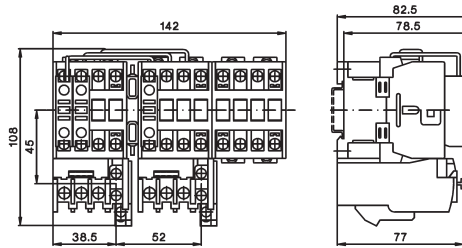

**K3PU24 + 2x U3/32
K3PU32**

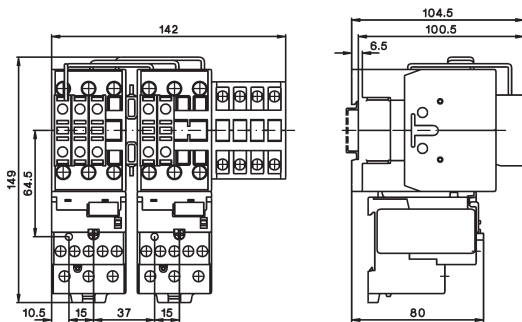

**K3PU50 + 2x U3/74
K3PU62**

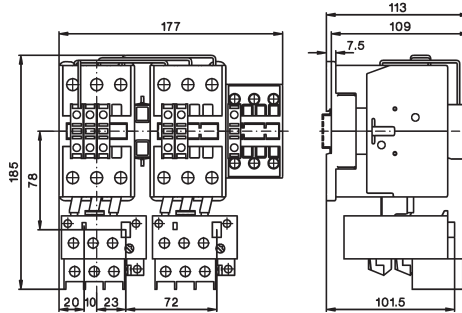

Pole Changing Starters, sheet steel enclosed, protected to IP54

K3NPU18B to K3PU32B

Type	Ø F	Ø G
K3NPU18B	25,5	25,5
K3PU24B	32,3	32,5
K3PU32B	32,3	32,5

Mounting by included fixing link

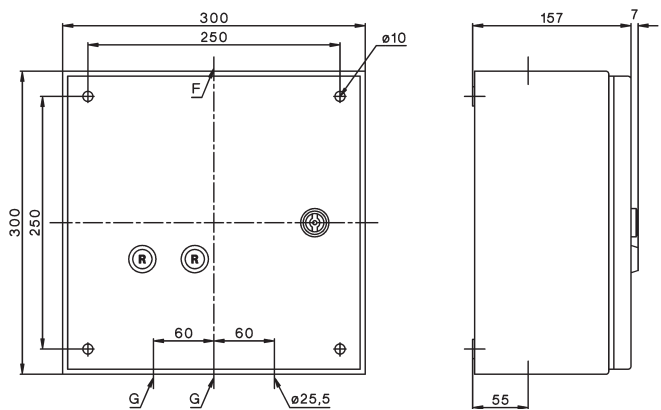
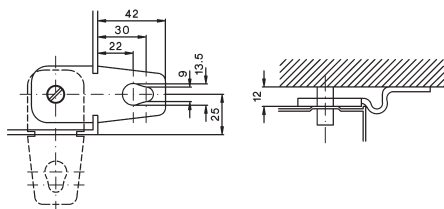



D.O.L. Starters With Start-Stop Buttons

112



D.O.L. Starters With Selector Switch

112



D.O.L. Starters With Selector Switch And Pneumatic Switch For Use In Moist Rooms

112



Enclosures

113



Accessories

113

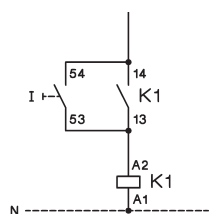

Wiring Diagrams

115

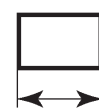

Dimensions

116

D.O.L. Starters In Plastic Enclosure

Ratings	Included	Free	order	Protec-	Conduit	Type	Coil voltage ¹⁾	Pack	Weight
AC3 at	Contact	Space	extra	tion	Entries			pcs.	kg/pc.
380V		f. Aux.		Degree			230 220-240V 50Hz		
400V		Cont.	Overload				400 380-415V 50Hz		
415V		HN..	Relay						
kW	Type	pcs.	Type						

D.O.L. Starters with Start-Stop/Reset Push Buttons



4	K3-10ND10	2	U12/16 K3	IP65	Ø 20,5mm	P1T10 ...	1	0,6
7,5	K3-18ND10	2	U12/16 K3	IP65	Ø 20,5mm	P1T18 ...	1	0,6
11	K3-22ND10	2	U12/16 K3	IP65	Ø 20,5mm	P1T22 ...	1	0,6

D.O.L. Starters with Selector Switch



4	K3-10ND10	2	U12/16 K3	IP65	Ø 20,5mm	P1W10 ...	1	0,6
7,5	K3-18ND10	2	U12/16 K3	IP65	Ø 20,5mm	P1W18 ...	1	0,6
11	K3-22ND10	2	U12/16 K3	IP65	Ø 20,5mm	P1W22 ...	1	0,6

D.O.L. Starters with Selector Switch and Pneumatic Switch for moist rooms



7,5	K3-18ND10	2	U12/16 K3	IP65	Ø 20,5mm	P1W18P ...	1	0,6
------------	-----------	---	-----------	------	----------	-------------------	---	-----

Push button and tube on request

Ordering Example: D.O.L. Starter with selector switch, plastic enclosed, rated AC3 at 400V 15,5A, rated control voltage 230V 50Hz - **Order Type:** **P1W18 230 + U12/16E 18 K3**

Pneumatic Button



						P1LT	1	
--	--	--	--	--	--	-------------	---	--

Air Pressure Hose



Length 5m						P1LS-5	1	
-----------	--	--	--	--	--	---------------	---	--

Pneumatic Switch



for refill of D.O.L. Starter P1W.. to P1W..P						P1-LDR	1	0,02
--	--	--	--	--	--	---------------	---	------

Thermal Overload Relays

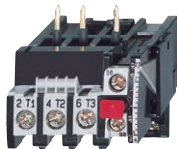

Setting range	Type	Pack	Weight
A		pcs.	kg/pc.
0,12 - 0,18	U12/16E 0,18 K3	1	0,10
0,18 - 0,27	U12/16E 0,27 K3	1	0,10
0,27 - 0,4	U12/16E 0,4 K3	1	0,10
0,4 - 0,6	U12/16E 0,6 K3	1	0,10
0,6 - 0,9	U12/16E 0,9 K3	1	0,10
0,8 - 1,2	U12/16E 1,2 K3	1	0,10
1,2 - 1,8	U12/16E 1,8 K3	1	0,10
1,8 - 2,7	U12/16E 2,7 K3	1	0,10
2,7 - 4	U12/16E 4 K3	1	0,10
4 - 6	U12/16E 6 K3	1	0,10
6 - 9	U12/16E 9 K3	1	0,10
8 - 11	U12/16E 11 K3	1	0,10
10 - 14	U12/16E 14 K3	1	0,10
13 - 18	U12/16E 18 K3	1	0,10
17 - 23	U12/16E 23 K3	1	0,10
22 - 30	U12/16E 30 K3	1	0,13

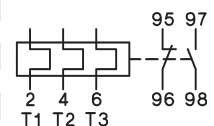

manual reset

Overload Relays with Quick Tripping Characteristic see page 120,121

Technical data see contactors page 62 and thermal overload relays page 125

1) Non-standard coil voltages see page 57

Enclosures for Contactors



Suitable for contactor	Protection Degree	Conduit Entries Top	Conduit Entries Bottom	Type	Pack pcs.	Weight kg/pc.
K3-07.. to K3-22.. K3-24..¹⁾ to K3-40..¹⁾	IP65	2 x Ø 20,5mm	2 x Ø 20,5mm	P1	1	0,35

with Reset Button



Suitable for contactor	Protection Degree	Conduit Entries Top	Conduit Entries Bottom	Type	Pack pcs.	Weight kg/pc.
K3-10.. to K3-22.. +U12/16.. K3	IP65	2 x Ø 20,5mm	2 x Ø 20,5mm	P1R	1	0,35

with Selector Switch



Suitable for contactor	Protection Degree	Conduit Entries Top	Conduit Entries Bottom	Type	Pack pcs.	Weight kg/pc.
K3-10.. to K3-22.. +U12/16.. K3	IP65	2 x Ø 20,5mm	2 x Ø 20,5mm	P1W	1	0,35

with Start-Stop Push Button



Suitable for contactor	Protection Degree	Conduit Entries Top	Conduit Entries Bottom	Type	Pack pcs.	Weight kg/pc.
K3-10.. to K3-22.. +U12/16.. K3	IP65	2 x Ø 20,5mm	2 x Ø 20,5mm	P1T	1	0,35

Indicator Units



Specifications	Voltage Range	Type	Pack pcs.	Weight kg/pc.
Coil Current Indicator , green (LED)	24 - 660V AC/DC	K2-ING	10	0,02
Coil Current Indicator , red (LED)	24 - 660V AC/DC	K2-INTR	10	0,02
To be connected in series with the contactor coil. In case of coil interruption the indicator goes out. Voltage drop approx. 2 volts				
Voltage Indicator , clear (glow-disc. I.)	220 - 415V AC/DC	K2-UN	10	0,02
Voltage Indicator , red (LED)	24 - 120V AC/DC	K2-UNR	10	0,02
To be connected parallel to the contactor coil. In case of applied voltage the indicator also lights at coil interruption.				

Lens Caps For Indicator Units

Lens cap transparent	LG9743T	10	0,005
Lens cap red	LG9743R	10	0,005
Lens cap green	LG9743GR	10	0,005

Mounting instructions see page 118

Heating Element



Specifications	Voltage Range	Power Consumption	Type	Pack pcs.	Weight kg/pc.
To avoid condensed water on places where high humidity is given together with alterations of ambient temperature	380 - 415V	1,5W	K2-HR	10	0,02
	220 - 240V	1,5W	K2-HR 230	10	0,02

Additional Terminals, Start Contact



Specification	Cable Cross-sections to clamp	flexib. w. multi-core cable end	Type	Pack pcs.	Weight kg/pc.	
Neutral Terminal	2 x 0,75-4	2 x 0,75-2,5	2 x 0,5-2,5	LG9744	10	0,009
Earth Terminal	2,5-16	1,5-10	1,5-10	LG9750	10	0,052
Mounting instructions see page 116						
Start Contact	for contactor K3-10 to K3-22	to be snapped on top of the auxiliary contact	LG9319-K3	10	0,03	

¹⁾ without auxiliary contact blocks

D.O.L. Starters

Wiring Diagrams Main Circuit

All fuses F0 shown in the main circuits are not included.
Terminal markings according to EN 50012

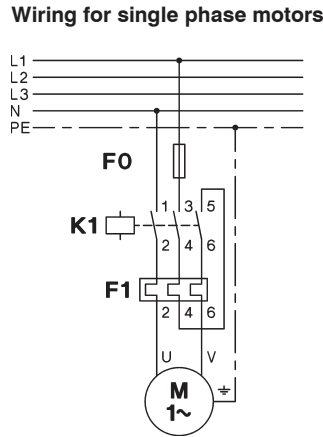
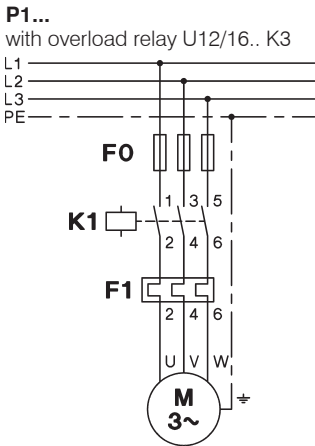

Wiring Diagrams Control Circuit

Coil connectors

Coils for **380-415V 50Hz** and **400-440V 60Hz**: The starter is supplied with control circuit connectors between terminals 1 (L1) and 5 (L3).
Coils for **220-240V 50Hz** and **230-264V 60Hz**: The starter is supplied with control circuit connectors between terminals 95 and 5 (L3). Connect neutral wire to terminal A1.
Coils for **other voltages**: Without connectors between supply and control circuit. Connect supply to terminals A1 and 95.

Separate coil supply

Coils for **380-415V 50Hz** and **400-440V 60Hz**: Remove connectors A1-1 and 95-5, connect supply to terminals A1 and 95.
Coils for **220-240V 50Hz** and **230-264V 60Hz**: Remove connectors 95-5 connect supply to terminals A1 and 95.
Coils for **other voltages**: Connect supply to terminals A1 and 95.

Coil phase to phase (380-415V 50Hz)

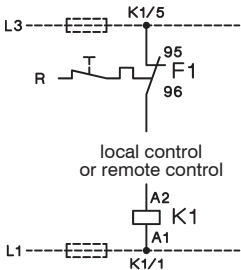

Coil phase to neutral (220-240V 50Hz)

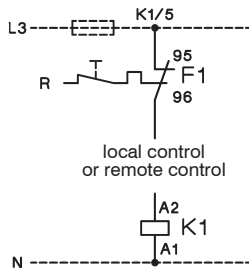

Coil phase to phase

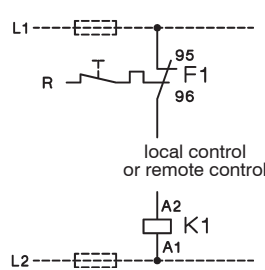

Coil phase to neutral

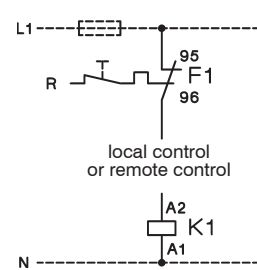

D.O.L. Starters with remote control

P1..
Remote 2-wire (switch) control

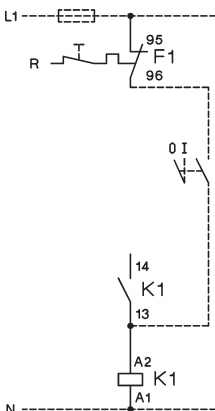

Remote 3-wire (push button) control

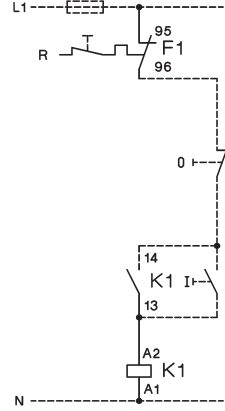

Remote start-stop control
(3 control stations)

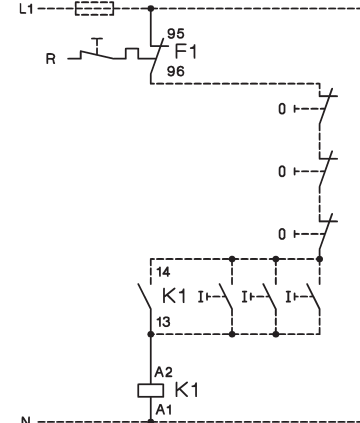

D.O.L. Starters

Wiring Diagrams Control Circuits

Typical circuit diagram (for separate coil supply, control circuit connected between L1 and N)
Terminal markings according to EN 50012

D.O.L. Starters with Start-Stop/Reset Push Buttons

P1T10, P1T18, P1T22
with overload relay U12/16.. K3

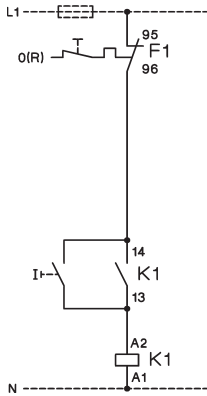

P1T10, P1T18, P1T22
with external push buttons

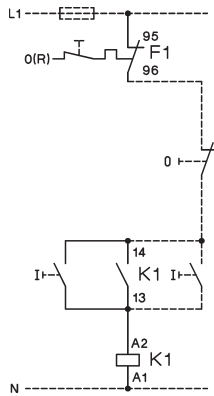

D.O.L. Starters with Selector Switch

P1W10, P1W18, P1W22
with external control switch

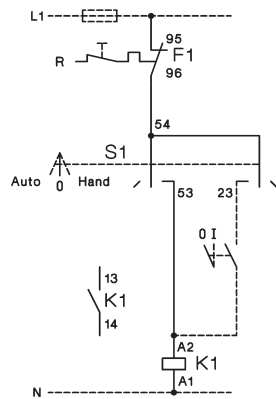

P1W10, P1W18, P1W22
with external push buttons

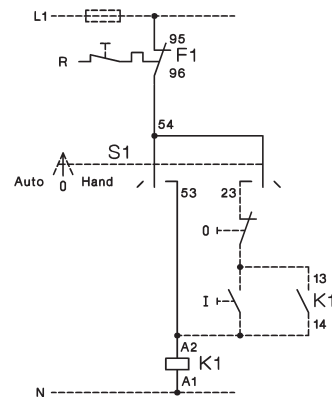

D.O.L. Starters with Selector Switch and Pneumatic Switch for Swimmingpool Control Gear and for use in Moist Rooms

P1W18P
with overload relay U12/16.. K3

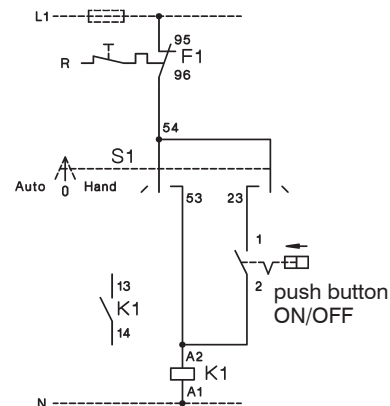

D.O.L. Starters

Dimensions

D.O.L. Starters with Start-Stop/Reset Push Buttons, Plastic Enclosed

P1T., P1TP.

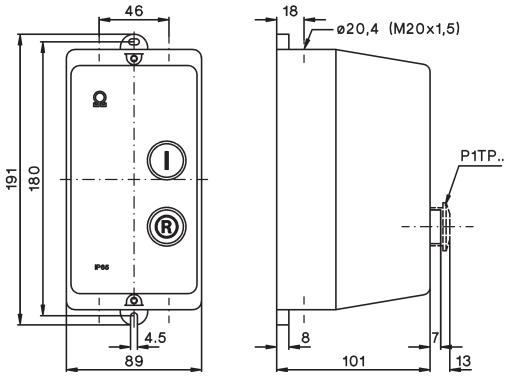

D.O.L. Starters with Selector Switch, Plastic Enclosed

P1W., P1W18P

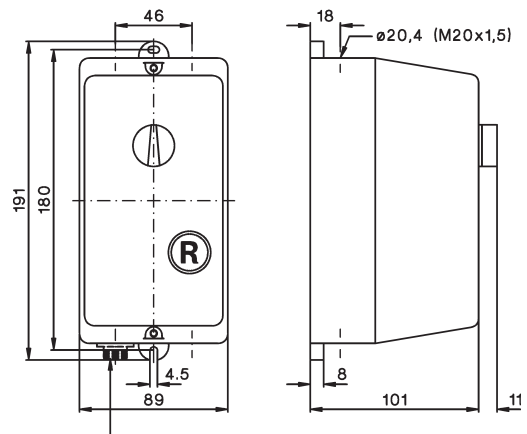

P1W18P: plug-in for air tube inside diameter 3mm

Rear Conduit Entries

knockouts
4 x Ø 23

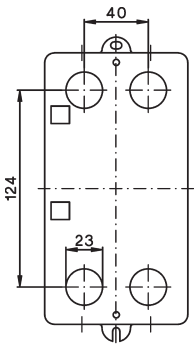

Earth Terminal LG9750 for K2-23 and K2-30 in Enclosure P1

for K2-23 and K2-30 remove spacing piece

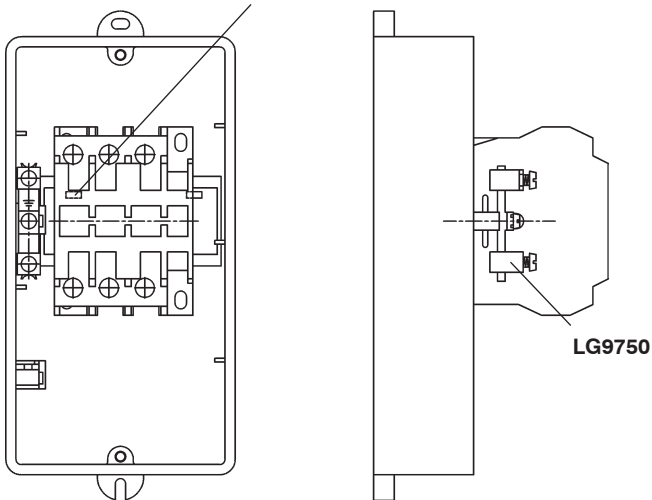

Neutral Terminal LG9744

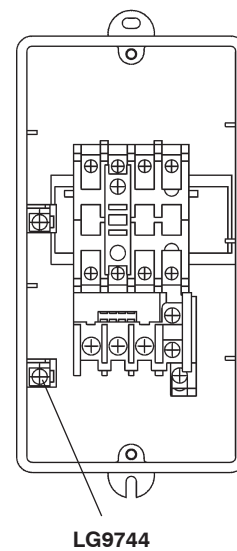

Enclosures

Dimensions

Enclosures for Contactors

P1

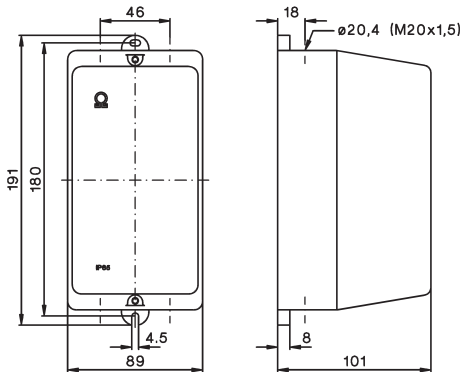

Enclosures for D.O.L. Starters

P1R, P1P

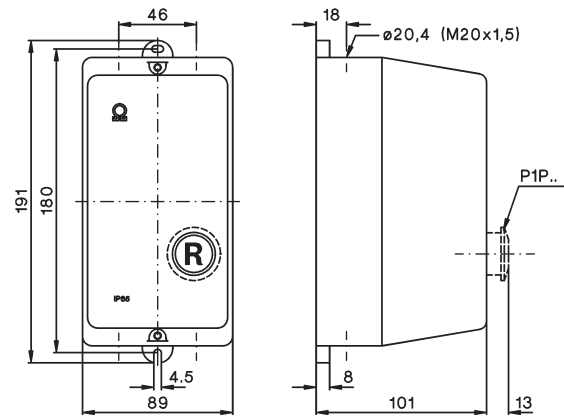

Rear Conduit Entries

knockouts
4 x $\phi 23$

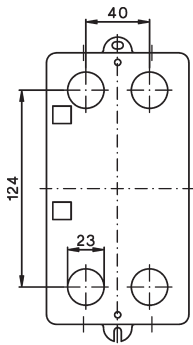

D.O.L. Starters

Mounting and Wiring Instructions

Indicators and Lens Caps for D.O.L. Starters P1

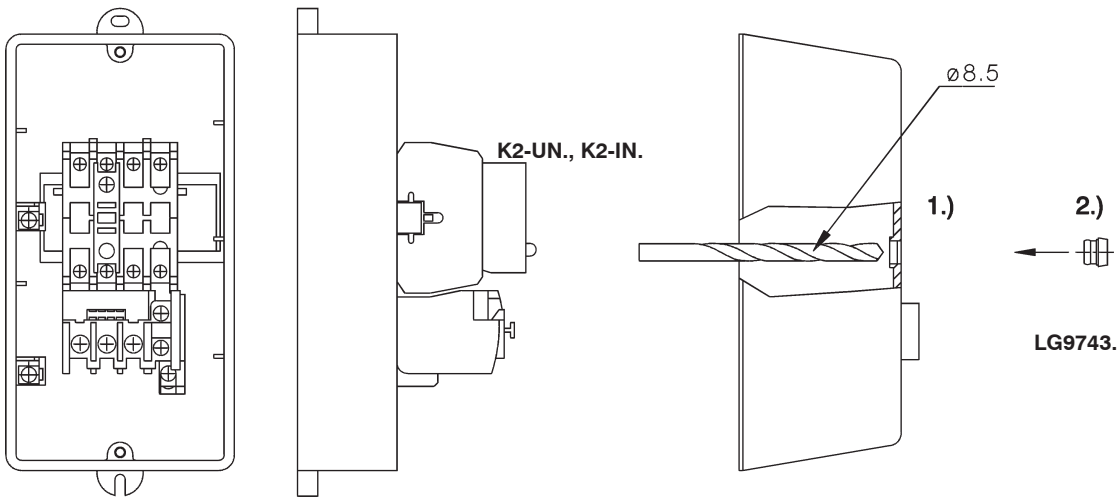

Wiring Examples

Coil Current Indicator

K2-ING
K2-INR

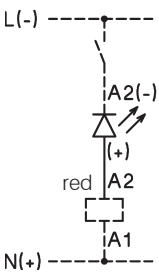

Voltage Indicator

K2-UN
K2-UNR

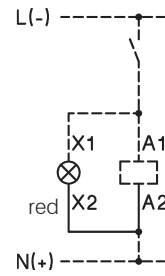

Heating Element

K2-HR

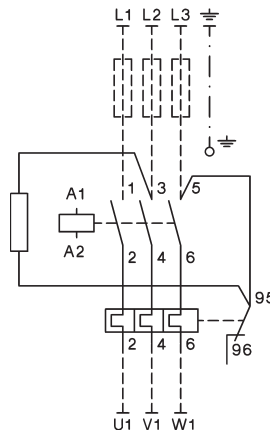

K2-HR 230

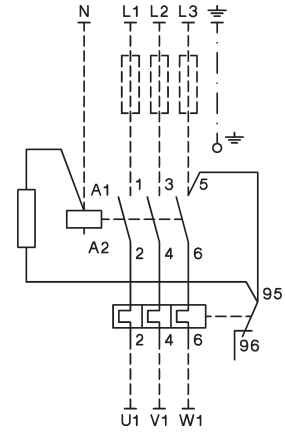

Colour mentioned in wiring diagrams refer to the outgoing connection wire of the device.

Start Contact LG9319-K3 for K3-10ND10 up to K3-22ND10

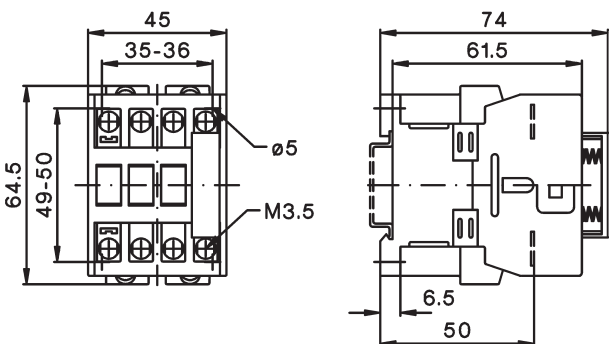



Thermal Overload Relays for Direct Mounting

120

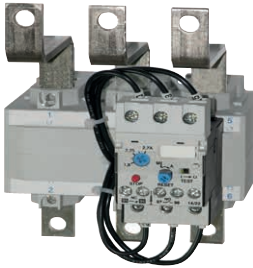

Thermal Overload Relays for Separate Mounting

122



Accessories

123



Technical Data

125

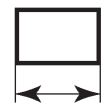

Dimensions

129

Thermal Overload Relays for plug-in mounting

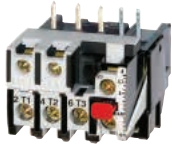

Setting Range			Type	Pack pcs.	Weight kg/pc.	Wiring Diagram
D.O.L. (A)	$\Upsilon\Delta$ (A)					
With Manual Reset , for contactors K1-..						
0,12 - 0,18	-	-	U12/16E 0,18 K1	1	0,10	<p>95 97 2 4 6 96 98 T1 T2 T3 manual reset</p>
0,18 - 0,27	-	-	U12/16E 0,27 K1	1	0,10	
0,27 - 0,4	-	-	U12/16E 0,4 K1	1	0,10	
0,4 - 0,6	-	-	U12/16E 0,6 K1	1	0,10	
0,6 - 0,9	-	-	U12/16E 0,9 K1	1	0,10	
0,8 - 1,2	-	-	U12/16E 1,2 K1	1	0,10	
1,2 - 1,8	-	-	U12/16E 1,8 K1	1	0,10	
1,8 - 2,7	-	-	U12/16E 2,7 K1	1	0,10	
2,7 - 4	-	-	U12/16E 4 K1	1	0,10	
4 - 6	7 - 10,5	-	U12/16E 6 K1	1	0,10	
6 - 9	10,5 - 15,5	-	U12/16E 9 K1	1	0,10	
8 - 11	14 - 19	-	U12/16E 11 K1	1	0,10	
10 - 14	18 - 24	-	U12/16E 14 K1	1	0,10	

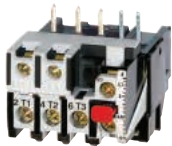

With Auto Reset , for contactors K1-..						
0,12 - 0,18	-	-	U12/16A 0,18 K1	1	0,10	<p>95 2 4 6 98 96 T1 T2 T3 auto reset or manual reset</p>
0,18 - 0,27	-	-	U12/16A 0,27 K1	1	0,10	
0,27 - 0,4	-	-	U12/16A 0,4 K1	1	0,10	
0,4 - 0,6	-	-	U12/16A 0,6 K1	1	0,10	
0,6 - 0,9	-	-	U12/16A 0,9 K1	1	0,10	
0,8 - 1,2	-	-	U12/16A 1,2 K1	1	0,10	
1,2 - 1,8	-	-	U12/16A 1,8 K1	1	0,10	
1,8 - 2,7	-	-	U12/16A 2,7 K1	1	0,10	
2,7 - 4	-	-	U12/16A 4 K1	1	0,10	
4 - 6	7 - 10,5	-	U12/16A 6 K1	1	0,10	
6 - 9	10,5 - 15,5	-	U12/16A 9 K1	1	0,10	
8 - 11	14 - 19	-	U12/16A 11 K1	1	0,10	
10 - 14	18 - 24	-	U12/16A 14 K1	1	0,10	

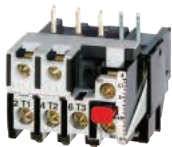

With Quick Tripping Characteristic for EEx e motors and submersible pumps, f. contactors K1-..						
0,4 - 0,6	-	-	U12/16EQ 0,6 K1	1	0,10	<p>95 97 2 4 6 96 98 T1 T2 T3 manual reset</p>
0,6 - 0,9	-	-	U12/16EQ 0,9 K1	1	0,10	
0,8 - 1,2	-	-	U12/16EQ 1,2 K1	1	0,10	
1,2 - 1,8	-	-	U12/16EQ 1,8 K1	1	0,10	
1,8 - 2,7	-	-	U12/16EQ 2,7 K1	1	0,10	
2,7 - 4	-	-	U12/16EQ 4 K1	1	0,10	
4 - 6	7 - 10,5	-	U12/16EQ 6 K1	1	0,10	
6 - 9	10,5 - 15,5	-	U12/16EQ 9 K1	1	0,10	
8 - 11	14 - 19	-	U12/16EQ 11 K1	1	0,10	
10 - 14	18 - 24	-	U12/16EQ 14 K1	1	0,10	

Thermal Overload Relays for plug-in mounting

Setting Range
D.O.L. (A) $\Upsilon\Delta$ (A) **Type** Pack pcs. Weight kg/pc. Wiring Diagram

With Manual Reset, for contactors K(G)3-10.. to K(G)3-22.. ..



0,12 - 0,18	-		U12/16E 0,18 K3	1	0,10
0,18 - 0,27	-		U12/16E 0,27 K3	1	0,10
0,27 - 0,4	-		U12/16E 0,4 K3	1	0,10
0,4 - 0,6	-		U12/16E 0,6 K3	1	0,10
0,6 - 0,9	-		U12/16E 0,9 K3	1	0,10
0,8 - 1,2	-		U12/16E 1,2 K3	1	0,10
1,2 - 1,8	-		U12/16E 1,8 K3	1	0,10
1,8 - 2,7	-		U12/16E 2,7 K3	1	0,10
2,7 - 4	-		U12/16E 4 K3	1	0,10
4 - 6	7 - 10,5		U12/16E 6 K3	1	0,10
6 - 9	10,5 - 15,5		U12/16E 9 K3	1	0,10
8 - 11	14 - 19		U12/16E 11 K3	1	0,10
10 - 14	18 - 24		U12/16E 14 K3	1	0,10
13 - 18	23 - 31		U12/16E 18 K3	1	0,10
17 - 23	30 - 40		U12/16E 23 K3	1	0,10
22 - 30	38 - 52		U12/16E 30 K3	1	0,13

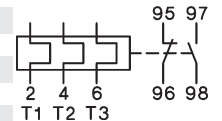

manual reset

With quick Tripping Characteristic for EEx e motors and under water pumps



0,4 - 0,6	-		U12/16EQ 0,6 K3	1	0,10
0,6 - 0,9	-		U12/16EQ 0,9 K3	1	0,10
0,8 - 1,2	-		U12/16EQ 1,2 K3	1	0,10
1,2 - 1,8	-		U12/16EQ 1,8 K3	1	0,10
1,8 - 2,7	-		U12/16EQ 2,7 K3	1	0,10
2,7 - 4	-		U12/16EQ 4 K3	1	0,10
4 - 6	7 - 10,5		U12/16EQ 6 K3	1	0,10
6 - 9	10,5 - 15,5		U12/16EQ 9 K3	1	0,10
8 - 11	14 - 19		U12/16EQ 11 K3	1	0,10
10 - 14	18 - 24		U12/16EQ 14 K3	1	0,10

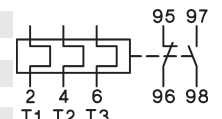

manual reset

For contactors K(G)3-10.. to K(G)3-40A..



0,12 - 0,18	-		U3/32 0,18	1	0,14
0,18 - 0,27	-		U3/32 0,27	1	0,14
0,27 - 0,4	-		U3/32 0,4	1	0,14
0,4 - 0,6	-		U3/32 0,6	1	0,14
0,6 - 0,9	-		U3/32 0,9	1	0,14
0,8 - 1,2	-		U3/32 1,2	1	0,14
1,2 - 1,8	-		U3/32 1,8	1	0,14
1,8 - 2,7	-		U3/32 2,7	1	0,14
2,7 - 4	-		U3/32 4	1	0,14
4 - 6	7 - 10,5		U3/32 6	1	0,14
6 - 9	10,5 - 15,5		U3/32 9	1	0,14
8 - 11	14 - 19		U3/32 11	1	0,14
10 - 14	18 - 24		U3/32 14	1	0,14
13 - 18	23 - 31		U3/32 18	1	0,14
17 - 24	30 - 41		U3/32 24	1	0,14
23 - 32	40 - 55		U3/32 32	1	0,14

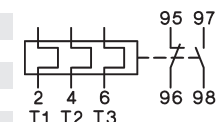

manual and auto reset

For contactors K(G)3-24A.. to K(G)3-40A ..



10 - 14	18 - 24		U3/42 14	1	0,30
14 - 20	24 - 35		U3/42 20	1	0,30
20 - 28	35 - 48		U3/42 28	1	0,30
28 - 42	48 - 73		U3/42 42	1	0,30

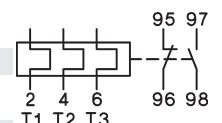

manual and auto reset

Thermal Overload Relays for plug-in mounting



Setting Range		Δ (A)	Type	Pack pcs.	Weight kg/pc.
D.O.L. (A)					
For contactors K3-50A.. to K3-74A..					
20 - 28	35 - 48		U3/74 28	1	0,40
28 - 42	48 - 73		U3/74 42	1	0,40
40 - 52	70 - 90		U3/74 52	1	0,40
52 - 65	90 - 112		U3/74 65	1	0,40
60 - 74	104 - 128		U3/74 74	1	0,40

Wiring Diagram

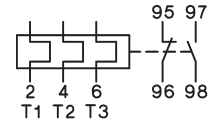

manual and auto reset

Thermal Overload Relays for separate mounting

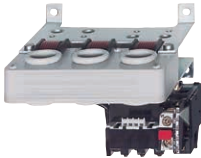

Setting Range		Δ (A)	Type	Pack pcs.	Weight kg/pc.
D.O.L. (A)					
For contactors K3-90, K3-115, K85, K110					
60 - 90	104 - 156		U85 90	1	0,90
80 - 120	140 - 207		U85 120		

Wiring Diagram

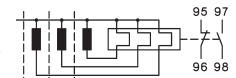

manual reset



For contactors K3-151.. and K3-176.., busbars included

120 - 180	208 - 312		U180 180	1	1,5
------------------	-----------	--	-----------------	---	-----

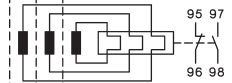

manual and auto reset



For contactors K3-210.. up to K3-316.., busbars included

144 - 216	250 - 374		U320 216	1	1,8
216 - 320	374 - 554		U320 320		



For contactors K3-315.., K3-450.., K3-550.., K3-700.., K3-860..

240 - 360	416 - 623		U800 360	1	4,1
360 - 540	623 - 935		U800 540	1	4,1
540 - 800	935 - 1385		U800 800	1	4,1

With Slow Tripping Characteristic for heavy duty starting with long run up times

For separate mounting, suitable for all contactors

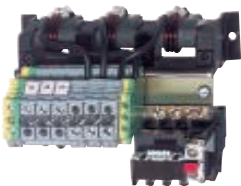

0,8 - 1,2	1,2 - 2,1		UAT21 1,2	1	1,0
1,2 - 1,8	2,1 - 3,1		UAT21 1,8	1	1,0
1,6 - 2,4	2,8 - 4,2		UAT21 2,4	1	1,0
2,4 - 3,7	4,2 - 6,4		UAT21 3,7	1	1,0
3,7 - 5,7	6,4 - 9,9		UAT21 5,7	1	1,0
5,3 - 8,2	9,2 - 14,2		UAT21 8,2	1	1,0
8 - 12	13,9 - 20,1		UAT21 12	1	1,0
12 - 18	20,1 - 31,2		UAT21 18	1	1,0
16 - 24	27,7 - 41,6		UAT22 24	1	1,1
24 - 37	41,6 - 64		UAT23 37	1	1,3
32 - 49	55,4 - 85		UAT23 49	1	1,3
48 - 72	83 - 125		UAT23 72	1	1,3

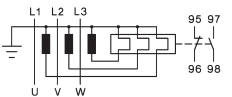

manual reset

Accessories



for overload relays	for contactors	Type	Pack set	Weight kg/set
Busbar Sets				
U800	K3-450.., K3-550..	SU840/550	1	1,7
U800	K3-700.., K3-860..	SU840/860	1	2,1

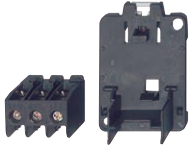

for overload relay	Cable Cross-section (mm ²)		Type	Pack pcs.	Weight kg/pc.
	solid or stranded	flexible			
Set for Single Mounting on DIN-rail with terminals					
U12/16..K3	0,75 - 6	0,75 - 4	U12SM K3	1	0,035



Additional Terminals with fingertouch protection					
U3/32	0,75 - 6	0,75 - 4	U3/32SM	1	0,035



Set for Single Mounting on DIN-rail					
U3/42, U3/74	-	-	U3/42G	1	0,030



Connecting Wire Set for U3/42, U3/74 with Single Mounting					
U3/42, U3/74	150mm lang	10mm ²	LG5830-4	1	0,060
U3/42, U3/74	250mm lang	10mm ²	LG5830-2	1	0,100



Additional Terminals with fingertouch protection					
1-pole f. U12/16, U3/32	0,75 - 10	0,75 - 6	LG9339	1	0,009
3-pole for U3/42	4 - 35	6 - 25	LG7559	1	0,052

Thermal Overload Relays, tripping times for selection to motors of protection degree EEx e

Relays With Standard Tripping Characteristic

Setting Range Tripping time depending on the multiple of the current setting from cold condition (tolerance $\pm 20\%$ of the tripping time)

A	A	I_A/I_N 3	I_A/I_N 4	I_A/I_N 5	I_A/I_N 6	I_A/I_N 7,2	I_A/I_N 8
U3/32 ..							
0,12 -	0,18	16,1	9,6	6,8	5,3	4,2	3,7
0,18 -	0,27	16,6	9,7	6,7	5,2	4,1	3,6
0,27 -	0,4	19,4	11,4	7,9	6,1	4,7	4,2
0,4 -	0,6	18,7	10,9	7,6	5,9	4,6	4,0
0,6 -	0,9	19,2	11,2	7,7	5,9	4,6	4,1
0,8 -	1,2	20,8	12,3	8,5	6,6	5,2	4,6
1,2 -	1,8	25,5	14,1	9,8	7,6	5,9	5,2
1,8 -	2,7	26,6	15,6	10,9	8,3	6,5	5,7
2,7 -	4	22,7	13,6	9,5	7,4	5,8	5,1
4 -	6	22,2	13,3	9,3	7,1	5,6	4,9
6 -	9	20,4	11,9	8,2	6,1	4,7	4,0
8 -	11	20,9	11,8	7,9	5,7	4,3	3,5
10 -	14	21,3	11,7	7,4	5,1	3,7	3,0
13 -	18	21,2	12,1	8,0	6,2	4,6	4,1
17 -	24	20,4	12,0	8,6	6,3	4,5	3,7
23 -	32	20,2	10,2	6,7	4,7	3,4	2,8

A	A	I_A/I_N 3	I_A/I_N 4	I_A/I_N 5	I_A/I_N 6	I_A/I_N 7,2	I_A/I_N 8
U3/42							
10 -	14	21,8	11,4	7,0	5,0	3,7	2,8
14 -	20	22,4	11,2	6,7	4,5	3,2	2,4
20 -	28	21,8	10,8	6,5	4,5	3,3	2,5
28 -	42	25,2	13,3	8,0	5,5	4,0	3,1

A	A	I_A/I_N 3	I_A/I_N 4	I_A/I_N 5	I_A/I_N 6	I_A/I_N 7,2	I_A/I_N 8
U3/74							
20 -	28	21,8	10,8	6,5	4,5	3,3	2,5
28 -	42	25,2	13,3	8,0	5,5	4,0	3,1
40 -	52	18,3	9,2	5,6	3,9	2,8	2,2
52 -	65	17,8	8,7	5,2	3,4	2,5	1,9

A	A	I_A/I_N 3	I_A/I_N 4	I_A/I_N 5	I_A/I_N 6	I_A/I_N 7,2	I_A/I_N 8
U85 ..							
60 -	90	19,5	13,5	11,0	10,0	9,5	8,5
80 -	120	18,0	11,0	10,0	9,0	8,5	8,0

A	A	I_A/I_N 3	I_A/I_N 4	I_A/I_N 5	I_A/I_N 6	I_A/I_N 7,2	I_A/I_N 8
U840 ..							
260 -	360	23,3	14,1	10,0	7,6	6,1	5,4
340 -	480	23,0	13,8	9,6	7,6	6,1	5,4
440 -	620	20,5	12,4	9,0	7,0	5,5	5,0
560 -	800	21,0	12,5	9,0	7,0	5,6	5,2

A	A	I_A/I_N 3	I_A/I_N 4	I_A/I_N 5	I_A/I_N 6	I_A/I_N 7,2	I_A/I_N 8
U12/16E(A) ..							
0,12 -	0,18	18,5	10,4	7,2	5,5	4,3	3,6
0,18 -	0,27	16,7	9,8	6,5	5,0	4,1	3,5
0,27 -	0,4	19,4	12,1	8,2	5,9	4,9	4,2
0,4 -	0,6	18,7	11,2	8,0	6,0	4,9	4,1
0,6 -	0,9	19,7	11,6	8,1	6,1	4,9	4,2
0,8 -	1,2	22,9	13,6	10,0	7,3	6,0	5,2
1,2 -	1,8	22,2	13,2	9,2	7,6	5,8	5,3
1,8 -	2,7	23,0	13,7	9,3	7,6	5,7	5,1
2,7 -	4	24,0	14,4	9,9	7,8	5,9	5,1
4 -	6	24,7	13,8	9,9	7,3	5,6	4,8
6 -	9	22,0	13,4	8	5,7	4,1	3,5
8 -	11	17,4	9,2	5,9	4,1	2,9	2,3
10 -	14	26,4	12,9	7,6	5,2	3,5	2,8
13 -	18	14,7	7,7	4,8	3,2	2,3	1,7
17 -	23	16,2	8,4	5,0	3,6	2,4	1,8
22 -	30	16,8	8,5	5,0	3,6	2,3	1,9

Relays With Quick Tripping Characteristic

preferably for motors with short t_E time and for submersible pumps

Setting Range Tripping time depending on the multiple of the current setting from cold condition (tolerance $\pm 20\%$ of the tripping time)

A	A	I_A/I_N 3	I_A/I_N 4	I_A/I_N 5	I_A/I_N 6	I_A/I_N 7,2	I_A/I_N 8
U12/16EQ ..							
0,4 -	0,6	13,6	8,4	5,9	4,2	3,3	3,0
0,6 -	0,9	13,8	7,8	5,2	4,1	3,2	2,7
0,8 -	1,2	13,1	7,5	5,2	3,9	3,1	2,7
1,2 -	1,8	14,6	8,7	6,0	4,6	3,6	3,2
1,8 -	2,7	13,5	7,6	5,3	3,9	3,1	2,7
2,7 -	4	11,0	6,0	4,1	2,6	1,7	1,4
4 -	6	9,6	5,3	3,3	2,3	1,6	1,3
6 -	9	10,2	5,4	3,4	2,3	1,6	1,3
8 -	11	12,0	6,2	3,9	2,5	1,8	1,3
10 -	14	12,8	6,6	4,0	2,6	1,8	1,4

All tripping times of overload relays U12/16EQ are shorter than the minimum values of the t_E time for motors of protection degree EEx e acc. to EN 50019 and therefore are suitable for all motors of protection degree EEx e. For these overload relays the selection on basis of tripping curves is thereby not necessary.

When selecting a standard overload, refer to the tripping curve. Determine the values of the starting current ratio I_A/I_N and the time t_E which is marked on the label of the motor. The overload must trip within the t_E time, which means that the tripping curve from cold condition must be (20% due to tolerance) below the co-ordination point I_A/I_N and the time t_E .
 I_A = Starting current of motor I_N = Rated current of motor
 t_E = t_E -time of motor

Time t_E /Tripping time

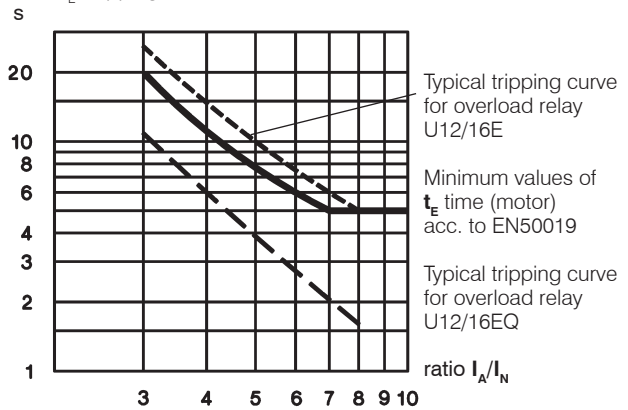

Labels of tripping curves for each setting range, sized 148x105mm (self-adhesive) are available on request. Order No. D588, specify type and setting range.

Example of selection for thermal overload relay:

Technical data of a motor protection EEx e
 $P_N = 1,5kW$ $I_N = 3,6A$ $I_A/I_N = 5$ t_E time = 8s

1) U12/16E 4 (2,7 - 4A)
 Tripping time at $5 \times I_N = 9,9s$
 $9,9s + 20\% \text{ tolerance} = 11,9s > t_{EMotor} = 8s$
 The device U12/16E 4 is **not suitable**.

2) U12/16EQ 4 (2,7 - 4A)
 Tripping time at $5 \times I_N = 4,1s$
 $4,1s + 20\% \text{ tolerance} = 4,9s < t_{EMotor} = 8s$
The device U12/16EQ 4 is therefore suitable for motor protection

Thermal Overload Relays

Fuses for U3/32, U3/42, U3/74, U12/16E, U85, U180, U320 and U800

Type	Setting Range		Max. Fuse Size According to Coordination-type				Fuse UL	SCCR
	DOL	Δ	"2" ¹⁾		"1" ¹⁾			
			quick A	slow, gL(gG) A	slow, gL(gG) A	aM A		
	A	A	A	A	A	A	kA	
U3/32 (U12/16E)	0,12 - 0,18	-	0,5 ²⁾	0,5 ²⁾	25	-	15	5
	0,18 - 0,27	-	1,0 ²⁾	1,0 ²⁾	25	-	15	5
	0,27 - 0,4	-	2	2	25	-	15	5
	0,4 - 0,6	-	2	2	25	-	15	5
	0,6 - 0,9	-	4	4	25	-	15	5
	0,8 - 1,2	-	4	4	25	2	15	5
	1,2 - 1,8	-	6	6	25	2	15	5
	1,8 - 2,7	-	10	10	25	4	15	5
	2,7 - 4	-	16	10	25	4	15	5
	4 - 6	7 - 10,5	20	16	25	6	15	5
	6 - 9	10,5 - 15,5	35	25	35	10	25	5
	8 - 11	14 - 19	35	25	35	16	30	5
	10 - 14	18 - 24	50	35	63	16	40	5
13 - 18	23 - 31	50	35	63	20	50	5	
17 - (23)24	30 - (40)41	63	50	63	25	60	5	
(22)23 - (30)32	(38)40 - (52)55	80	63	80	35	70	5	
U3/42	10 - 14	18 - 24	50	35	80	16	40	5
	14 - 20	24 - 35	63	50	80	25	60	5
	20 - 28	35 - 48	80	63	80	35	80	5
	28 - 42	48 - 73	100	80	150	50	110	5
U3/74	20 - 28	35 - 48	100	80	150	35	80	5
	28 - 42	48 - 73	125	100	150	50	110	5
	40 - 52	70 - 90	160	100	150	63	200	5
	52 - 65	90 - 112	160	125	150	80	250	10
	60 - 74	104 - 128	160	125	150	80	250	10
U85	60 - 90	104 - 156					300	10
	80 - 120	140 - 207					-	10
U180, U320 U800	all ranges all ranges						-	-

For short circuit protecting overload relays with current transformer use fuse according to the contactor of the combination.

Tripping Characteristics for U3/32, U3/42, U3/74 and U12/16E

Detailed tripping times for each range see table page 124

with three-phase load

Tripping time min. s (Average value of typical tolerance curves from cold condition)

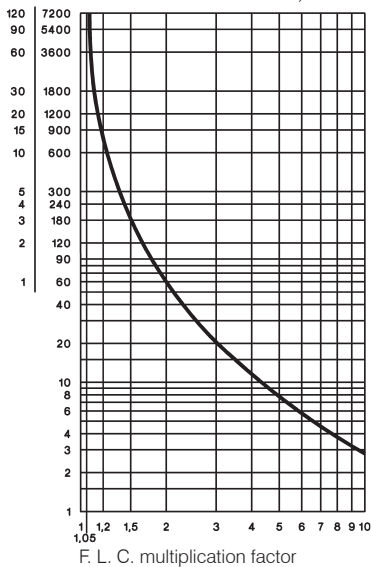

with two-pole load

Tripping time min. s (Typical tolerance curve from cold condition)

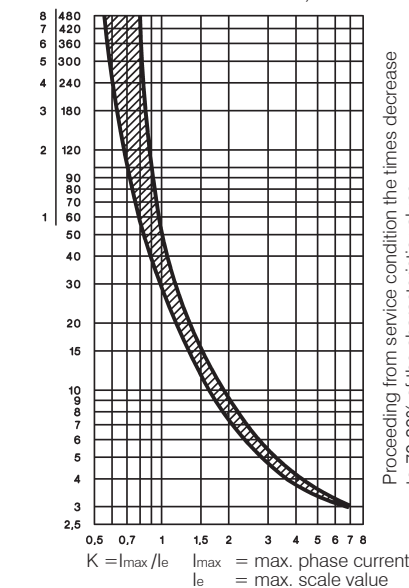

1) Coordination-type according to IEC 947-4-1:
 "2": Light contact welding accepted. Thermal overload relay must not be damaged.
 "1": Welding of contactor and damage of the thermal overload relay allowed.
 2) Miniature fuse

3) Suitable for use on a capability of delivering not more than

Thermal Overload Relays

Tripping Characteristics for U85, U180, U320, and U800

Detailed tripping times for each range of U85 see table page 124

U85 with three-phase load

Tripping time (Average value of typical tolerance curves from cold condition)

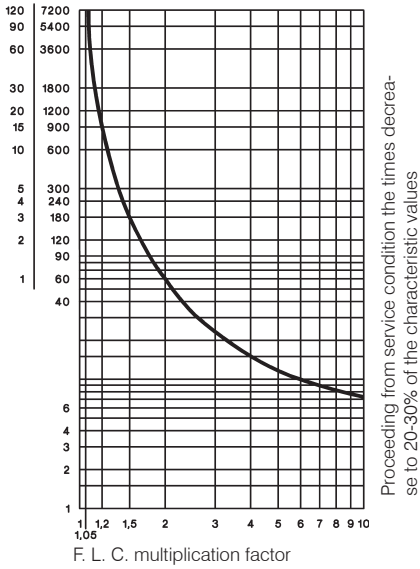

U180, U320 with three-phase load

Tripping time (Average value of typical tolerance curves from cold condition)

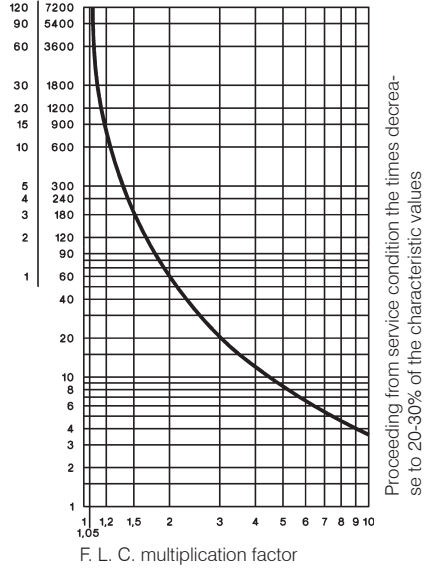

U800 with three-phase load

Tripping time (Average value of typical tolerance curves from cold condition)

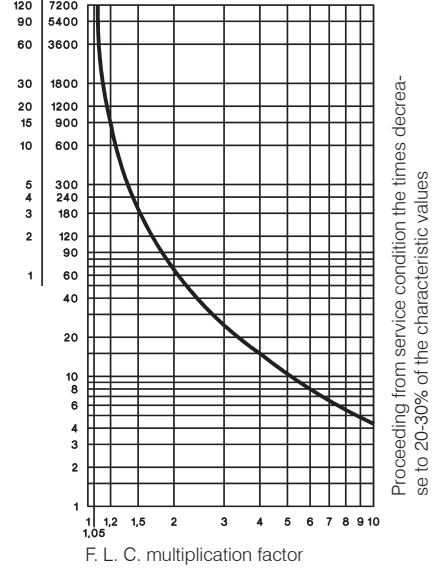

U85 with two-pole load

Tripping time (Typical tolerance curve from cold condition)

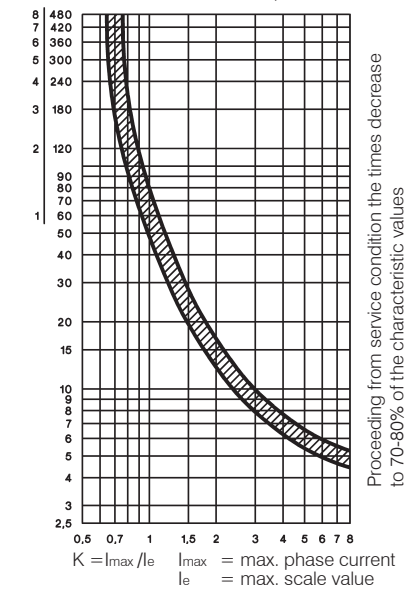

Position of Terminals

U3/32

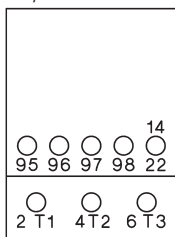

U12/16E, U12/16EM, U12/16EQ

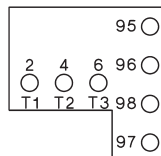

U12/16A

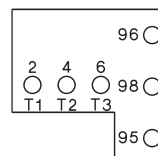

U3/42, U3/74

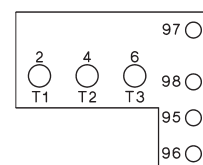

Thermal Overload Relays in Special Version

Fuse for U12/16EQ

Setting Range	Maximum Fuse Acc. to Coordination-type		
	"2" ¹⁾ quick A	slow, gL(gG) A	"1" ¹⁾ slow, gL(gG) A
0,4 - 0,6	2	2	25
0,6 - 0,9	4	4	25
0,8 - 1,2	4	4	25
1,2 - 1,8	6	6	25
1,8 - 2,7	10	10	25
2,7 - 4	16	10	25
4 - 6	20	16	25
6 - 9	35	25	35
8 - 11	35	25	35
10 - 14	50	35	63

Fuse for U12/16EM

Setting Range	Maximum Fuse Acc. to Coordination-type "2" ¹⁾		
	380-400V slow, gL(gG) A	500V slow, gL(gG) A	660-690V slow, gL(gG) A
0,12 - 0,18	none	none	on request
0,18 - 0,27	none	none	on request
0,27 - 0,4	none	none	on request
0,4 - 0,6	none	none	on request
0,6 - 0,9	none	none	on request
0,8 - 1,2	none	10	on request
1,2 - 1,8	none	16	on request
1,8 - 2,7	20	20	on request
2,7 - 4	35	35	on request

Tripping Characteristic for U12/16EQ

Detailed tripping times for each range see table page 124

with three-phase load

range 0,4-0,6 to 1,8-2,7A

Tripping time (Typical tolerance curve from cold condition)

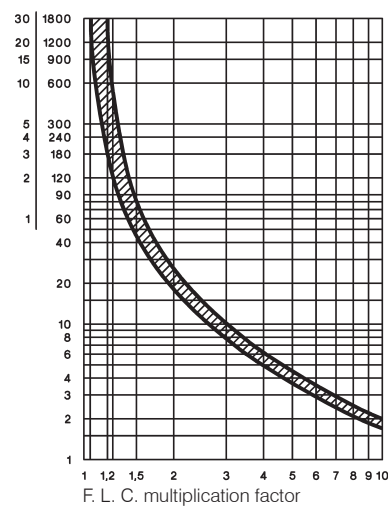

range 2,7-4 to 10-14A

Tripping time (Typical tolerance curve from cold condition)

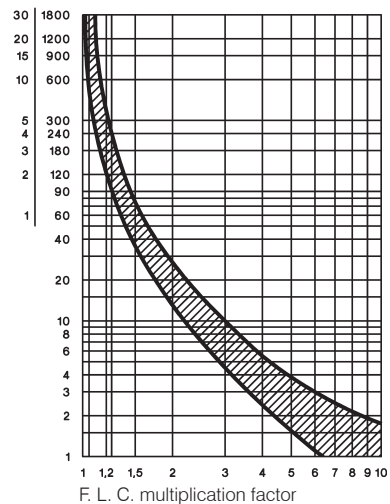

Tripping Characteristic for U12/16EM

with three-phase load

Tripping time (Average value of typical tolerance curves from cold condition)

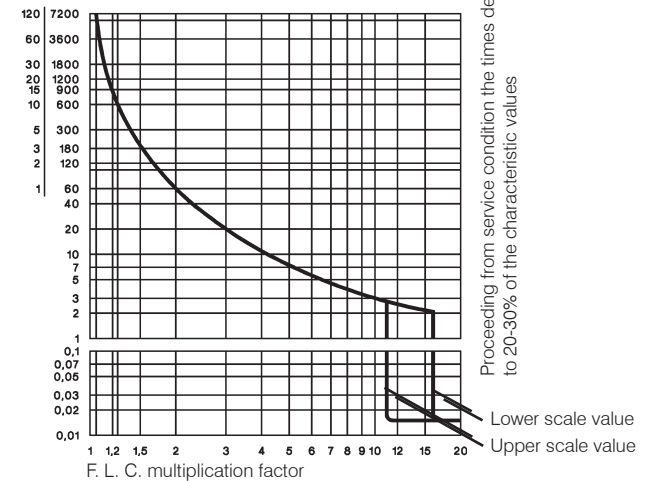

Fuse for UAT21, UAT22, UAT23

For short circuit protecting thermal overload relays with current transformer use fuse according to the contactor of the combination.

Tripping characteristic for UAT21, UAT22, UAT23

with three-phase load

Tripping time in s (Typical tolerance curve from cold condition)

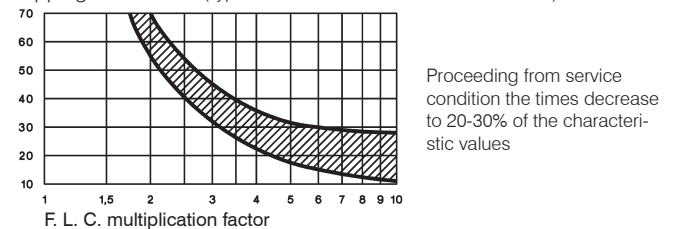

1) Coordination-type according to IEC 947-4-1:
 "2": Light contact welding accepted. Thermal overload relay must not be damaged.
 "1": Welding of contactor and damage of the thermal overload relay allowed.

Thermal Overload Relays

Data according to IEC 947-4-1, IEC 947-5-1, VDE 0660, EN 60947-4-1, EN 60947-5-1

Type	U3/32	U12/16 ⁶⁾	U3/42	U3/74	U85	U180	U320	U800	UAT21	UAT22	UAT23		
Rated insulation voltage $U_i^{1)}$	V~	690	690	690	690	750	1000	1000	1000	690	690	690	
Permissible ambient temperature													
operation	open			-25 to +60					-25 to +55			-25 to +60	
storage				-50 to +70					-40 to +70			-50 to +70	
Trip class according to IEC 947-4-1	10A	10A	10A	10A	20	10A	10A	10	30	30	30		
Cable cross-section													
main connector	solid or stranded	mm ²	0,75-6	0,75-6+0,75-2,5 ²⁾	0,75-10	4-35 ²⁾	3)	7)	-	7)	0,5-10	0,5-16	0,5-25
	flexible	mm ²	1-4	0,75-4+0,5-2,5 ²⁾	0,75-6	6-25 ²⁾					0,5-6	0,5-10	0,5-16
	flexible with multicore cable end	mm ²	0,75-4	0,5-2,5+0,5-1,5	0,75-6	4-25					0,5-6	0,5-10	0,5-16
Cables per clamp	number		2	1+1	2	1					1	1	1
auxiliary connector	solid	mm ²			0,75-2,5 ²⁾				1-2,5 ²⁾				0,75-2,5 ²⁾
	flexible	mm ²			0,5-2,5 ²⁾				1-2,5 ²⁾				0,5-2,5 ²⁾
	flexible with multicore cable end	mm ²			0,5-1,5				1-2,5 ²⁾				0,5-1,5
Cables per clamp	number				2				2				2

Type	U3/32	U12/16A	U12/16E	U12/16EQ	U3/42	U85	U180	U800	UAT21	UAT22	UAT23
Auxiliary contacts											
Rated insulation voltage $U_i^{1)}$											
same potential	V~	690	690	690	690	690	690	500	690		
different potential	V~	440	-	440	440	250	440	440	500	440	
Utilization category AC15											
Rated operational current I_e	24V A	3	4	5	5	4	5	3	4 ⁵⁾	5	
	230V A	2	2,5	3	3	2,5	3	2	2,5	3	
	400V A	1	1,5	2	2	1,5	2	1	1,5	2	
	690V A	0,5	0,6	0,6	0,6	0,6	0,6	0,5	0,6	0,6	
Utilization category DC13											
Rated operational current I_e	24V A	1	1,2	1,2	1,2	1,2	1,2	1	1,2	1,2	
	110V A	0,15	0,15	0,15	0,15	0,15	0,15	0,15	0,15	0,15	
	220V A	0,1	0,1	0,1	0,1	0,1	0,1	0,1	0,1	0,1	
Short circuit prot. (without welding 1kA)											
highest fuse rating	gL (gG) A	4	4	6	6	6	6	4	6	6	

Type	U3/32	U12/16	U12/16E	U3/42	U3/42	U3/74	U3/74	U85
Setting range	all	to 23A	22 - 30A	to 28A	28 - 42A	to 52A	52 - 65A	all
Power loss per current path (max.)								
minimum setting value	W	1,1	1,1	1,7	1,3	1,3	2,0	1,1
maximum setting value	W	2,3	2,3	3,7	2,6	3,3	3,7	2,5

Data according to cULus

Type	U3/32	U12/16A	U12/16E	U12/16EQ	U3/42	U3/74	U85
Rated insulation voltage	V~	600	600	600	600	600	600
Rated current	A	32	23	23	23	42	85
Auxiliary contacts							
Rated voltage							
same potential	V~	600	600	600	600	600	600
different potential	V~	150	-	150	150	150	150
Switching capacity AC	VA	500	500	500	500	600	600
of aux. contacts	A	2	3	4	4	4	4

Temperature Compensation

In case of higher ambient temperature use the following formula:
(Ambient temperature - 20) x 0,125 = correction factor in % of the full load motor current

Example: Ambient temperature 70°C, full load motor current 7A
(70 - 20) x 0,125 = 6,25%
Setting value: 7A + 6,25% = 7,44A

1) Suitable for: earthed-neutral systems, overvoltage category I to III, pollution degree 3 (standard-industry): $U_{imp} = 4kV$ (at 440V), 6kV (at 690V).

Data for other conditions on request.

2) Maximum cable cross-section with prepared conductor

3) Without terminals, suitable for bushing one connector 70mm² (stranded) per phase

4) Switching capacity of the start contact: AC15 300VA, max. 1,5A, DC13 (max. 220V) 30W, max. 1,5A

5) Switching capacity of the make contact: AC15 400VA, max. 1,7A, DC13 (max. 220V) 10W, max. 1A

6) U12/16E 30: Cable cross-section for main connector like type U3/42, one connector only

7) Busbar sets see accessories page 123

Thermal Overload Relays

Dimensions

K3-10N + U3/32

K3-14N

K3-18N

K3-22N

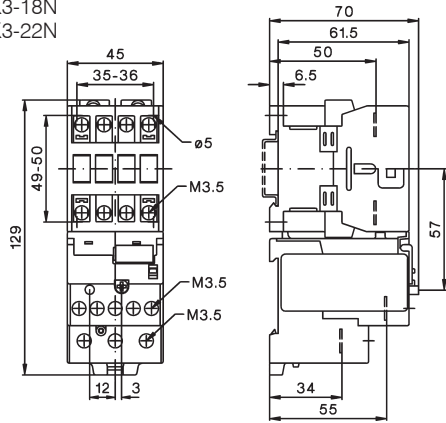

KG3-10 + U3/32

KG3-14

KG3-18

KG3-22

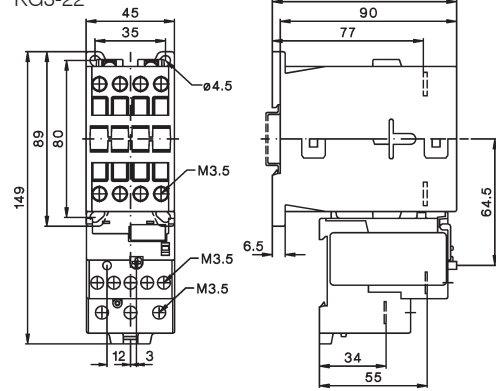

K3-24 + U3/32

K3-32

K3-40

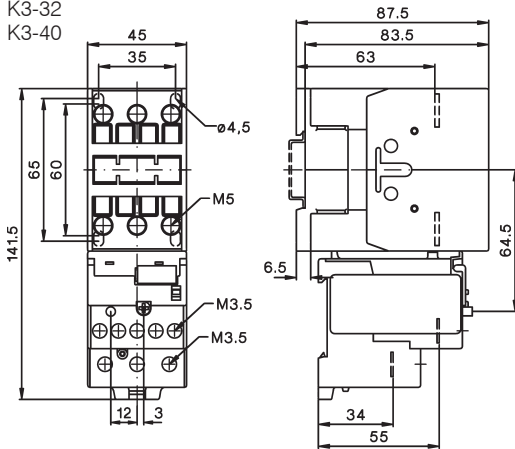

KG3-24 + U3/32

KG3-32

KG3-40

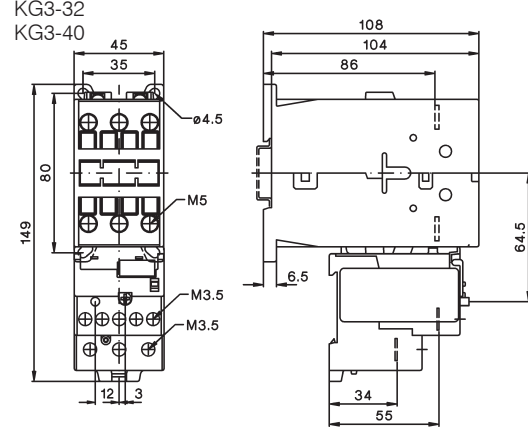

K3-24 + U3/42

K3-32

K3-40

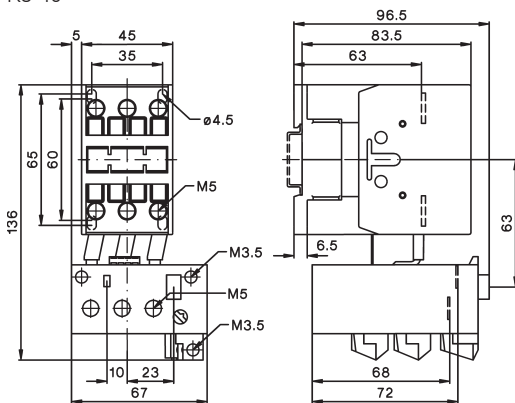

KG3-24 + U3/42

KG3-32

KG3-40

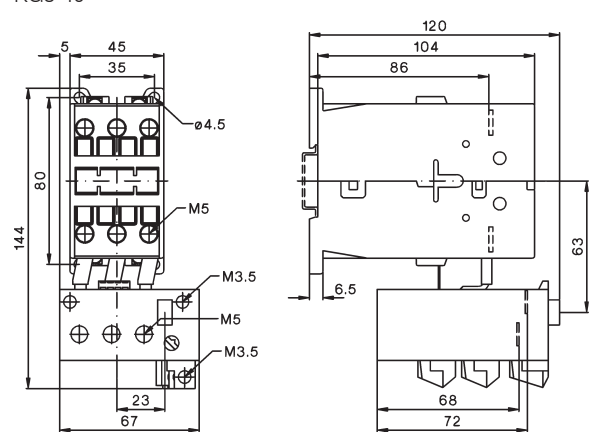

U3/32SM

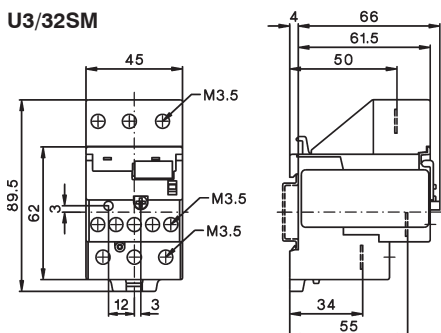

U3/42G + LG5830-

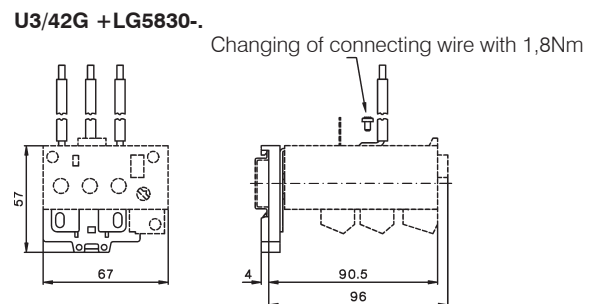

Thermal Overload Relays

Dimensions

K1-09 + U12/16..K1
K1-12

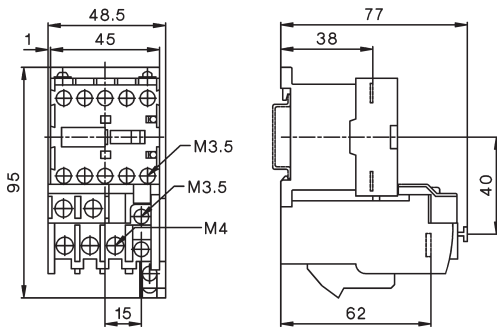

K3-10 + U12/16..K3
K3-14
K3-18
K3-22

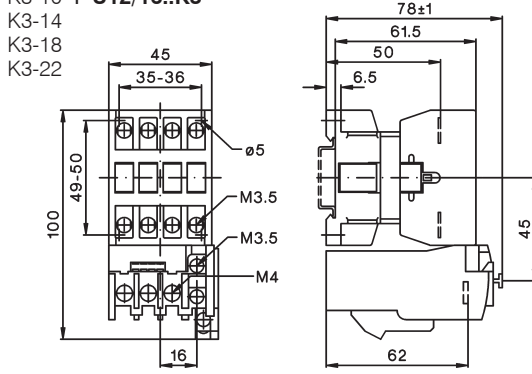

K3-10N + U12/16..K3
K3-14N
K3-18N
K3-22N

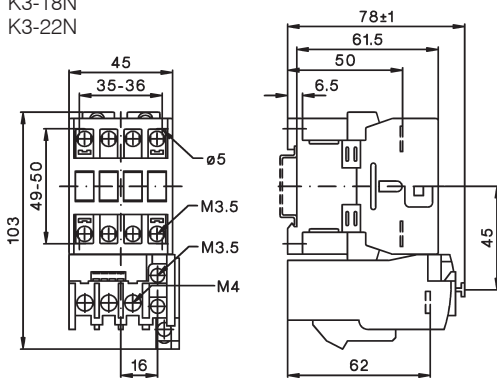

KG3-10 + U12/16..K3
KG3-14
KG3-18
KG3-22

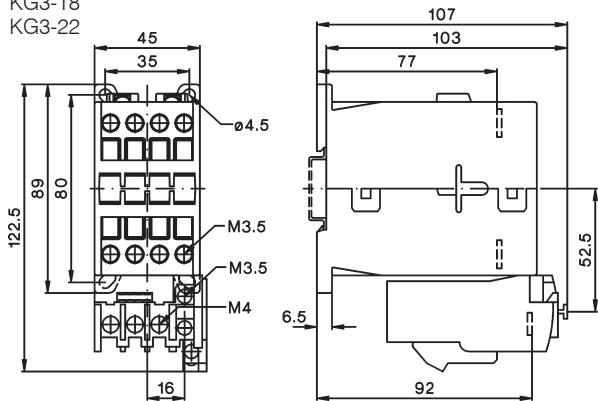

U12SM K3

U12/16..K3 + U12SM K3 for snap-on 35mm DIN-rail according to DIN EN50022 and screw mounting (single mounting)

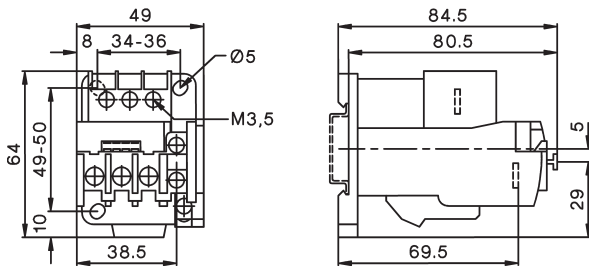

K3-50 + U3/74
K3-62
K3-74

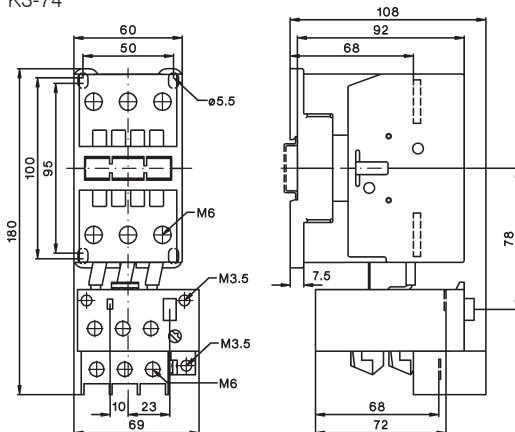

Thermal Overload Relays

Dimensions

K3-90A + U85
K3-115A

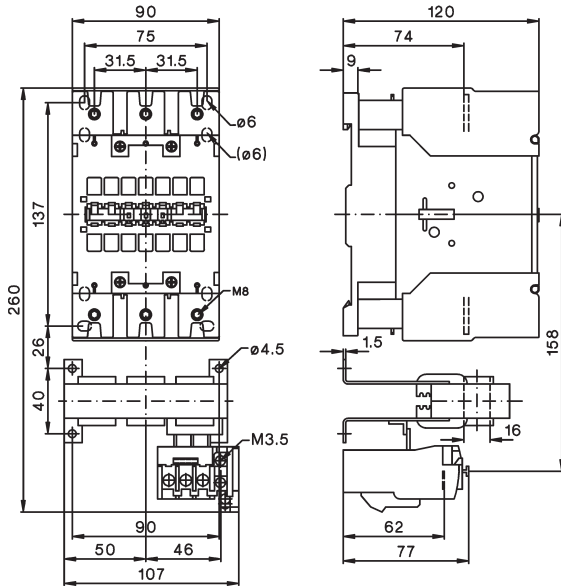

K3-151A00 + U180
K3-176A00

Mounting holes

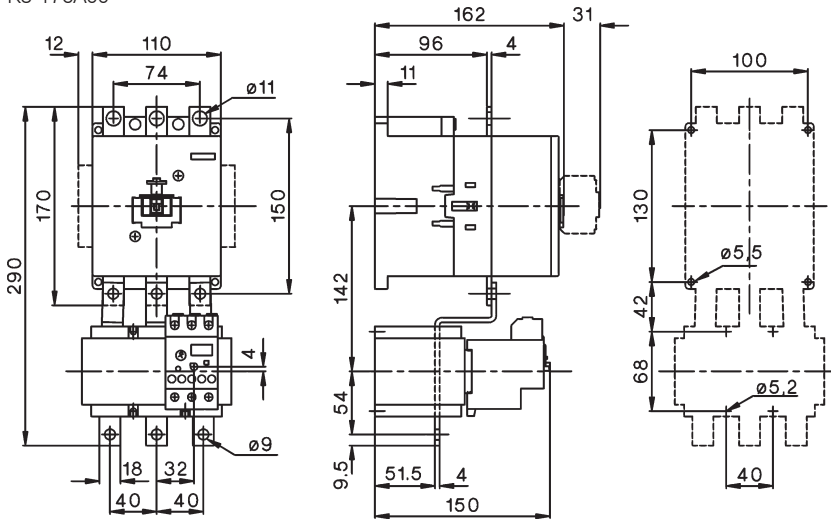

K3-210A00 + U320
K3-260A00
K3-316A00

Mounting holes

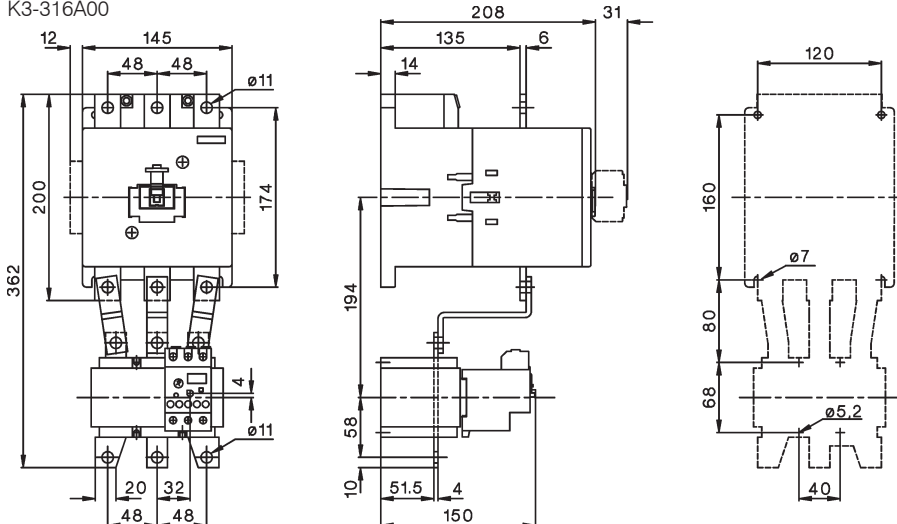

Thermal Overload Relays

Dimensions

U800

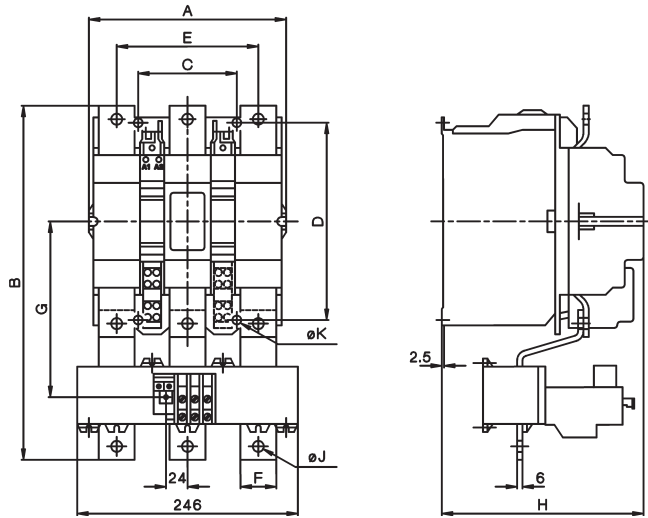
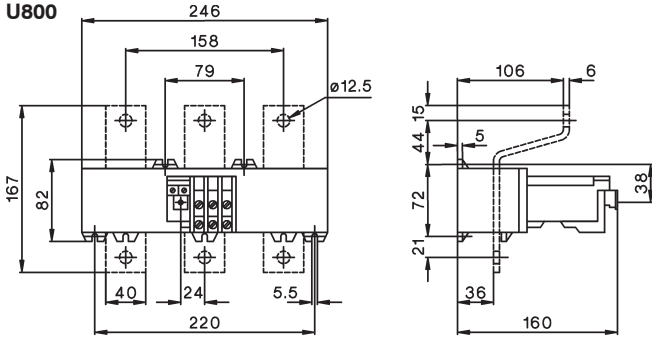

U800 with	A	B	C	D	E	F	G	H	J	K
K3-450	220	372	110	220	158	40	185	225	12,5	9
K3-550	220	395	110	220	158	40	196	225	12,5	9
K3-700	280	487	175	280	202	50	257	291	14,5	11
K3-860	280	540	175	280	202	50	280	291	14,5	11

UAT21

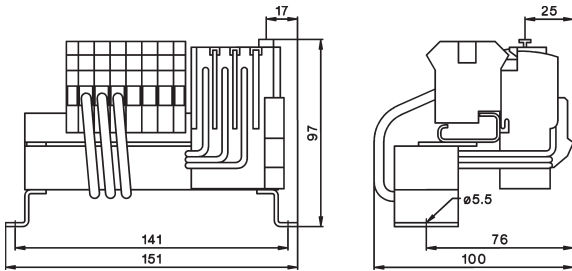

UAT22

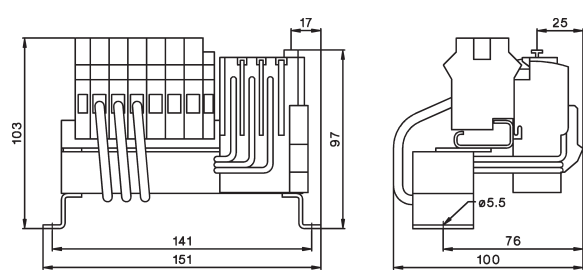

UAT23

Type	Setting Range	A	B
UAT23 37	23-37A	105,5	97,5
UAT23 49	32-49A	94	86
UAT23 72	48-72A	94	86

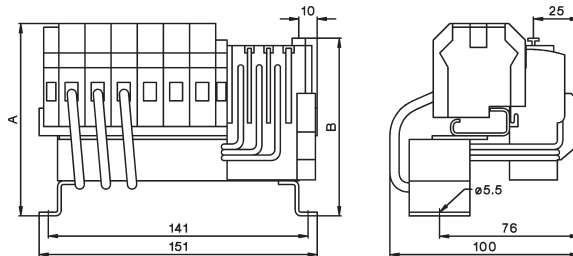



Modular Contactors

134



Auxiliary Contact Block
Accessories

135

135



Day-Night Reloading Contactors

136



Switching Of Lamps

136



Technical Data

138



Dimensions

140

Modular Contactors

Rated Current	Heating Power AC1 at		Type	coil voltage	Pack pcs.	Weight kg/pc.	Wiring Diagram
	1-phase	3-phase					
AC1 400V A	230V kW	400V kW	24 230 24VM 230VM ↓	24V 50/60Hz 220-240V 50Hz, 230-264V 60Hz 24V 50/60Hz, 24V DC 220-240V 50/60Hz, 220V DC			

One-pole 1 module (17,5mm), AC-operated (low noise)



20	4,6	-	R20-10 24	12	0,12
20	4,6	-	R20-10 230	12	0,12



Two-pole 1 module (17,5mm), AC-operated (low noise)



20	4,6	-	R20-20 24	12	0,12
20	4,6	-	R20-20 230	12	0,12

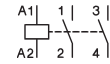

20	4,6	-	R20-11 24	12	0,12
20	4,6	-	R20-11 230	12	0,12

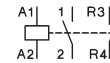

20	4,6	-	R20-02 24	12	0,12
20	4,6	-	R20-02 230	12	0,12

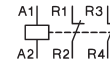

25	5,5	-	R25-20 24	12	0,14
25	5,5	-	R25-20 230	12	0,14

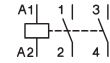

25	5,5	-	R25-11 24	12	0,14
25	5,5	-	R25-11 230	12	0,14

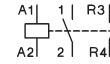

25	5,5	-	R25-02 24	12	0,14
25	5,5	-	R25-02 230	12	0,14

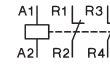

Four-pole 2 modules (35mm) ¹⁾, AC-operated (low noise)



25	5,7	17	R25-40 24	6	0,21
25	5,7	17	R25-40 230	6	0,21

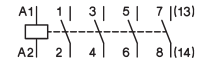

25	5,7	17	R25-31 24	6	0,21
25	5,7	17	R25-31 230	6	0,21

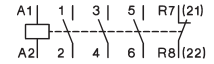

25	5,7	17	R25-13 24	6	0,21
25	5,7	17	R25-13 230	6	0,21

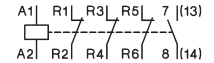

25	5,7	-	R25-22 24	6	0,21
25	5,7	-	R25-22 230	6	0,21

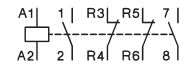

25	5,7	17	R25-04 24	6	0,21
25	5,7	17	R25-04 230	6	0,21

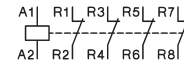

Four-pole 2 modules(35mm), AC/DC-operated ¹⁾, (hum free)



25	5,7	17	R25-40 24VM	6	0,22
25	5,7	17	R25-40 230VM	6	0,22

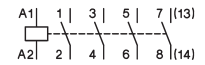

25	5,7	17	R25-31 24VM	6	0,22
25	5,7	17	R25-31 230VM	6	0,22

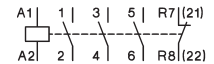

25	5,7	17	R25-13 24VM	6	0,22
25	5,7	17	R25-13 230VM	6	0,22

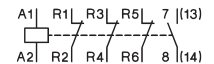

25	5,7	-	R25-22 24VM	6	0,22
25	5,7	-	R25-22 230VM	6	0,22



25	5,7	17	R25-04 24VM	6	0,22
25	5,7	17	R25-04 230VM	6	0,22

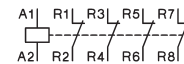

1) Sealable with Sealing Cover P721, available aux. contact block RH11(see page 135)
2) Sealable with Sealing Cover P721, available aux. contact block RH11-1(see page 135)

Modular Contactors

Rated Current	Heating Power AC1 at	Type	coil voltage	
400V	1-phase 3-phase	24	24V 50/60Hz	
A	230V 400V	230	220-240V 50Hz, 230-264V 60Hz	
	kW kW	↓	Pack pcs.	Weight kg/pc.
				Wiring Diagram



Two-pole 2 modules (35mm), AC-operated (low noise)

40	9	-	R40-20 24	6	0,23
40	9	-	R40-20 230	6	0,23
40	9	-	R40-02 24	6	0,23
40	9	-	R40-02 230	6	0,23
63	14,3	-	R63-20 24	6	0,23
63	14,3	-	R63-20 230	6	0,23
63	14,3	-	R63-02 24	6	0,23
63	14,3	-	R63-02 230	6	0,23

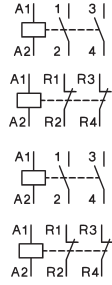

Four-pole 3 modules (52,5mm)¹⁾, AC-operated (low noise)

40	9	27,5	R40-40 24	4	0,35
40	9	27,5	R40-40 230	4	0,35
40	9	27,5	R40-31 24	4	0,35
40	9	27,5	R40-31 230	4	0,35
40	9	-	R40-22 24	4	0,35
40	9	-	R40-22 230	4	0,35
40	9	27,5	R40-04 24	4	0,35
40	9	27,5	R40-04 230	4	0,35
63	14,3	43	R63-40 24	4	0,36
63	14,3	43	R63-40 230	4	0,36
63	14,3	43	R63-31 24	4	0,36
63	14,3	43	R63-31 230	4	0,36
63	14,3	-	R63-22 24	4	0,36
63	14,3	-	R63-22 230	4	0,36
63	14,3	43	R63-04 24	4	0,36
63	14,3	43	R63-04 230	4	0,36

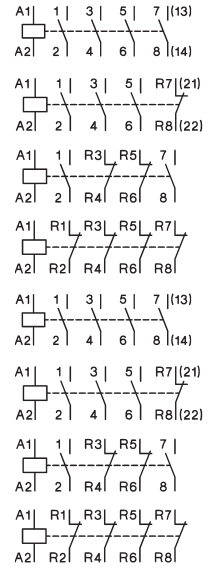

Auxiliary Contact Block 1/2 module (8,8mm) for contactor R25, R40, R63 (4p.) max. 1 piece for contactor R40 and R63 (2p.) max. 1 piece



Rated current	AC15 AC1	Type	Pack pcs.	Weight kg/pc.	Wiring Diagram
230V	400V 400V				
A	A A	for contactor			
3	2 10	R25 ²⁾ , R40, R63	RH11	3	0,026
3	2 10	R25-..VM	RH11-1	3	0,026



Accessories



RC-unit	2x for R20.. to R63.. for 12V to 250V AC 220nF / 100 Ohm not for R25-..VM	RC-R 230	2	0,05
Spacing piece	1/2 module (8,8mm) for R20.. to R63.. for ambient temperature >40°C	P730	10	0,012
Sealing cover	for R25.. (4p.)	P721	10	0,002
Sealing cover	for R40.., R63..	P690	10	0,003

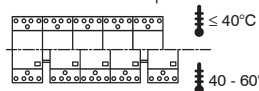

1) Sealable with Sealing Cover P690, available aux. contact block RH11
 2) AC-operated R25-..., 4-pole

Day-Night Reloading Contactors

	Type	Pack pcs.	Weight kg/pc.	Wiring Diagram
--	-------------	-----------	---------------	----------------

Compact Module, for separate tariff counters 2 modules (35mm), AC-operated (low noise)



3-pole 400V 25A **R25-TN 230** 1 0,22

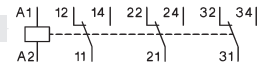

2 Switch positions:

Day (Reloading, contact 11-14 ... closed, remains in position Night, until the next occurs)

Night (Basis operation) contact 11-12 ... closed

Contactor Module, for double tariff counters 1 module (17,5mm), AC-operated (low noise)



2-pole 400V 25A **R25-TN20 230** 1 0,13

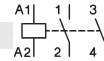

4 Switch position:

Day (Reloading, contact 1-2 ... closed, remains in position Night, until the next occurs)

Night (automatic operation, contact 1-2 ... only at night closed)

On (Permanently On)

Off (permanently Off)

Switch Module 1 module (17,5mm)



2-pole 400V 25A **RH25-20** 1 0,13



Modular Contactors

Switching of lamps

Lamp Type	Power W	Current A	Capacitors μF	Max. lamps per pole at 230V 50Hz and max. 60°C			
				R20..	R25..	R40..	R63..
Incandescent lamps	60	0,27	-	36	50	92	129
	100	0,45	-	21	30	55	77
	200	0,91	-	10	15	27	38
	300	1,36	-	7	10	19	26
	500	2,27	-	4	6	11	16
	1000	4,5	-	2	3	6	8
Fluorescent lamps uncompensated or serial compensated	11	0,16	1,3	60	75	210	310
	18	0,37	2,7	25	30	90	140
	24	0,35	2,5	25	30	90	140
	36	0,43	3,4	20	25	70	140
	58	0,67	5,3	14	17	45	70
	65	0,67	5,3	13	16	40	65
Fluorescent lamps dual-connection	11	0,07	-	2 x 100	2 x 110	2 x 220	2 x 250
	18	0,11	-	2 x 50	2 x 55	2 x 130	2 x 200
	24	0,14	-	2 x 40	2 x 44	2 x 110	2 x 160
	36	0,22	-	2 x 30	2 x 33	2 x 70	2 x 100
	58	0,35	-	2 x 20	2 x 22	2 x 45	2 x 70
	65	0,35	-	2 x 15	2 x 16	2 x 40	2 x 60
Fluorescent lamps parallel compensated	11	0,09	2	33	43	67	107
	18	0,13	2	25	32	50	80
	24	0,16	3	25	32	50	80
	36	0,27	4	22	32	50	80
	58	0,45	7	14	18	36	46
	65	0,5	7	14	18	36	46
85	0,6	8	12	16	33	44	

Modular Contactors

Switching of lamps

Lamp Type	Power W	Current A	Capacitors μF	Max. lamps per pole at 230V 50Hz and max. 60°C				
				R20..	R25..	R40..	R63..	
Fluorescent lamps with electronic fluorescent lamp ballast	18	0,09	-	40	40	100	150	
	36	0,16	-	20	20	52	75	
	58	0,25	-	15	15	30	55	
	80	0,4	-	7	10	20	30	
	2 x 18	0,17	-	20	20	50	60	
	2 x 28	0,25	-	15	15	37	45	
	2 x 36	0,32	-	10	10	25	30	
	2 x 58	0,49	-	7	7	15	20	
2 x 80	0,7	-	4	4	8	10		
Transformers for metal halid low voltage lamps	20	0,09	-	40	52	110	174	
	50	0,22	-	20	24	50	80	
	75	0,33	-	13	16	35	54	
	100	0,43	-	10	12	27	43	
	150	0,65	-	7	9	19	29	
	200	0,87	-	5	5	14	23	
300	1,3	-	3	4	9	14		
Mercury-vapour lamps (high-pressure lamps), uncompensated e. g. HQL, HPL	50	0,61	-	16	21	38	55	
	80	0,8	-	12	16	29	40	
	125	1,15	-	8	11	20	28	
	250	2,15	-	4	6	11	15	
	400	3,25	-	3	4	7	10	
	700	5,4	-	1	2	4	6	
	1000	7,5	-	1	1	3	4	
Mercury-vapour lamps (high-pressure lamps), compensated e. g. HQL, HPL	50	0,28	7	14	18	36	50	
	80	0,41	8	12	16	31	44	
	125	0,65	10	10	13	25	35	
	250	1,22	18	5	7	14	19	
	400	1,95	25	4	5	10	14	
	700	3,45	45	2	3	6	8	
	1000	4,8	60	1	2	4	6	
Metal halide lamps uncompensated e. g. HQI, HPI, CDM	35	0,53	-	22	24	57	65	
	70	1	-	12	14	30	35	
	150	1,8	-	6	8	17	18	
	250	3	-	4	5	10	12	
	400	3,5	-	3	4	8	10	
	1000	9,5	-	1	1	3	4	
	2000	16,5	-	-	-	2	2	
	400V per pole	2000	10,5	-	-	2	2	
	3500	18	-	-	-	1	1	
	Metal halide lamps compensated e. g. HQI, HPI, CDM	35	0,25	6	16	21	42	58
		70	0,45	12	8	11	21	29
		150	0,75	20	5	7	13	18
		250	1,5	33	3	4	9	11
400		2,1	35	2	4	9	10	
1000		5,8	95	1	1	3	4	
2000		11,5	148	-	-	2	2	
400V per pole		2000	6,6	58	-	-	3	4
3500		11,6	100	-	-	2	3	
Metal halide lamps with electronic fluorescent with electronic fluorescent lamp ballast (e. g.: PCI) 50-125 x I _{n lamp} for 0,6ms		20	0,1	integrated	9	9	18	20
	28	0,15	integrated	-	-	-	18	
	35	0,2	integrated	6	6	11	13	
	70	0,36	integrated	5	5	10	12	
	150	0,7	integrated	4	4	8	10	
Sodium-vapour lamps (low pressure lamps), uncompensated	35	1,5	-	7	9	22	30	
	55	1,5	-	7	9	22	30	
	90	2,4	-	4	6	13	19	
	135	3,3	-	3	4	10	14	
	150	3,3	-	3	4	10	14	
	180	3,3	-	3	4	10	14	
	200	3,3	-	3	4	10	14	

Modular Contactors

Switching of lamps

Lamp Type	Power W	Current A	Capacitors µF	Max. lamps per pole at 230V 50Hz and max. 60°C			
				R20..	R25..	R40..	R63..
Sodium-vapour lamps (low pressure lamps), compensated	35	0,31	20	5	6	15	18
	55	0,42	20	5	6	15	18
	90	0,63	30	3	4	10	12
	135	0,94	45	2	3	7	8
	150	1	40	2	3	8	9
	180	1,16	40	2	3	8	9
	200	1,32	25	-	-	10	12
Sodium-vapour lamps (high pressure lamps), uncompensated	150	1,8	-	5	8	17	22
	250	3	-	4	5	10	13
	330	3,7	-	3	4	8	10
	400	4,7	-	2	3	6	8
	1000	10,3	-	1	1	3	4
Sodium-vapour lamps (high pressure lamps), compensated	150	0,83	20	5	7	20	25
	250	1,5	33	3	4	12	15
	330	2	40	2	3	10	13
	400	2,4	48	2	2	8	12
	1000	6,3	106	1	1	4	6
Sodium-vapour lamps (high pressure lamps) with serial electronic (e. g.: PCI) 50-125 x I _{nlamp} for 0,6ms	20	0,1	integrated	9	9	18	20
	35	0,2	integrated	6	6	11	13
	70	0,36	integrated	5	5	10	12
	150	0,7	integrated	4	4	8	10
LED-Lamps consider the inrush current of the lamp ballast and the cosφ of the lamp	max. inrush current of contactor [A] $\frac{\text{inrush current of contactor}}{\text{inrush current of lamp/EVG}} =$			195A	233A	424A	565A
				max. lamps per pole at 230V 50Hz and max. 60°C			

Data according to IEC60 947-4-1, IEC 60947-5-1, VDE 0660-5-1

Type	2-pole				4-pole			RH11	
	R20	R25	R40	R63	R25	R40	R63		
Main Contacts ^{5) 6) 7)}									
Rated insulation voltage U_i	V~	440²⁾	440²⁾	440²⁾	440²⁾	440²⁾	440²⁾	440²⁾	
Rated operation voltage U _e	V~	440	440	440	440	440	440	440	
Frequency of operations z AC1, AC3	1/h	300	300	600	600	300	600	600	
Mechanical life	S x 10 ⁶	1	1	1	1	1	1	1	
Utilization category AC1 / AC7a Switching of resistive load									
Rated operational current I _e (=I _{th}) open at 60°C	A	20	25	40	63	25	40	63	-
Contact life	S x 10 ⁶	0,1	0,1	0,1	0,1	0,1	0,1	0,1	-
Minimum Switch Voltage	V/mA	24/100	24/100	24/100	24/100	24/100	24/100	24/100	17/5
Short time current 10s-current	A	72	72	216	240	72	216	240	-
Power loss per pole at I _e /AC1	W	2	3	3	7	2	3	7	0,5
Utilization category AC2 and AC3 / AC7b Switching of three-phase motors									
Rated operational current I _e	A	-	-	-	-	9	27	30	-
Rated operational power of three-phase motors									
220V	kW	-	-	-	-	2,2	7,5	8	-
230-240V	kW	-	-	-	-	2,5	8	8,5	-
380-415V	kW	-	-	-	-	4	12,5	15	-
2-pole motors	230V kW	1,1	1,3	2,6	5	-	-	-	-
Contact life	S x 10 ⁶	0,15	0,15	0,15	0,15	0,15	0,15	0,15	-
Power consumption of coils									
AC operated									
inrush	VA	7 - 9	7 - 9			20 - 25	33 - 45	33 - 45	-
sealed	VA	2,2 - 4,2	2,2 - 4,2	5 - 7	5 - 7	4 - 6	6 - 8	6 - 8	-
	W	0,8 - 1,6	0,8 - 1,6			1,5 - 2,5	2,6	2,6	-
AC and DC-operated	W	-	-			3 - 4	-	-	-
Operation range of coils in multiples of control voltage U _s (-40° - +40°C)		0,85 - 1,1	0,85 - 1,1	0,85 - 1,1	0,85 - 1,1	0,85 - 1,1	0,85 - 1,1	0,85 - 1,1	-

1) Suitable for: earthed-neutral systems, overvoltage category I to IV, pollution degree 3 (standard-industry): U_{imp} = 8kV.

2) Suitable for: earthed-neutral systems, overvoltage category I to III, pollution degree 3 (standard-industry): U_{imp} = 4kV.

3) Maximum cable cross-section with prepared conductor

5) Rated frequency 50/60Hz

6) Max. occ. switching overvoltage <4kV

7) Duty cycle: 100%

Modular Contactors

Data according to IEC60 947-4-1, IEC 60947-5-1, VDE 0660-5-1

Type	R20	R25 (2p.)	R25 (4p.)	R25-..VM	R40 (2p./4p.)	R63 (2p./4p.)	RH11		
Maximum ambient temperature									
Operation	open °C			-40 to + 60		40 - 60°C			
	enclosed °C			-40 to + 40		≤ 40°C			
Storage	°C			-50 to + 90					
Short circuit protection									
max. fuse Coordination-type "1"gL (gG)	A	35	35	35	63	80	-		
Rated short circuit current	"I _{sc} "	3	3	3	3	3	-		
	"I _q "	3	3	10	10	10	-		
Switching time at control voltage U _s ± 10%									
make time	ms	7 - 16	7 - 16	9 - 15	17 - 24	11 - 15	11 - 15		
release time	ms	6 - 12	6 - 12	4 - 8	17 - 23	6 - 13	6 - 13		
arc duration	ms	10 - 15	10 - 15	10 - 15	10 - 15	10 - 15	10 - 15		
Cable cross-sections									
Main connector	solid or stranded	mm ²	1,5 - 10	1,5 - 10	1,5 - 10	1,5 - 10	2,5 - 25	2,5 - 25	0,5 - 2,5 ³⁾
	flexible	mm ²	1,5 - 6	1,5 - 6	1,5 - 6	1,5 - 6	2,5 - 16	2,5 - 16	0,5 - 2,5 ³⁾
	flexible with multicore cable end	mm ²	1,5 - 6	1,5 - 6	1,5 - 6	1,5 - 6	2,5 - 16	2,5 - 16	0,5 - 1,5
Clamps per pole			1	1	1	1	1	1	2
Magnetic coil	solid or stranded	mm ²	0,75 - 2,5	0,75 - 2,5	0,75 - 2,5	0,75 - 2,5	0,75 - 2,5	0,75 - 2,5	-
	flexible	mm ²	0,5 - 2,5	0,5 - 2,5	0,5 - 2,5	0,5 - 2,5	0,5 - 2,5	0,5 - 2,5	-
	flexible with multicore cable end	mm ²	0,5 - 1,5	0,5 - 2,5	0,5 - 1,5	0,5 - 1,5	0,5 - 1,5	0,5 - 1,5	-
Clamps per pole			1	1	1	1	1	1	-
Auxiliary Contacts ^{5) 6) 7)}									
Rated insulation voltage U _i ¹⁾	V AC	-	-	440 ²⁾	440 ²⁾	440 ²⁾	440 ²⁾	440 ²⁾	
Thermal rated current I _{th}	40°C	A	-	25	25	40	63	10	
Ambient temperature	60°C	A	-	25	25	40	63	6	
Utilization category AC15									
Rated operational current I _e	220-240V	A	-	-	3	3	3	3	
	380-415V	A	-	-	2	2	2	2	
	440V	A	-	-	1,6	1,6	1,6	1,6	
Utilization category DC13									
Rated operational current I _e	24-60V	A	-	-	2	2	2	2	
	110V	A	-	-	0,4	0,4	0,4	0,4	
per pole	220V	A	-	-	0,1	0,1	0,1	0,1	
Short circuit protection									
short-circuit current 1kA, contact welding not accepted									
max. fuse size	gL (gG)	A	-	-	10	10	10	10	

Data according to UL508

Main Contacts (cULus)	Type	R20	R25 (2p.)	R25 (4p.)	R40 (2p./4p.)	R63 (2p./4p.)	RH11
Rated operational current "General Use"	A	20	25	25	40	63	10
Rated operational power of three-phase motors at 60Hz (3ph)	110-120V hp	-	-	1	2	3	-
	200-208V hp	-	-	2	5	7½	-
	220-240V hp	-	-	3	7½	10	-
	265-277V hp	-	-	3	7½	10	-
Rated operational power of AC motors at 60Hz (1ph)	110-120V hp	½	½	½	1	1½	-
	200-208V hp	1	1	1	2	3	-
	220-240V hp	1½	1 ½	1½	3	5	-
	265-277V hp	1½	2	2	3	5	-
Fuses	A	40	40	40	80	80	-
Suitable for use on a capability of delivering not more than	rms	5000	5000	5000	5000	5000	-
	V	300	300	300	300	300	300
Rated operation voltage	V~	300	300	300	300	300	300
Auxiliary Contacts (cULus)	heavy pilot duty	AC	-	-	-	-	C300

2) Suitable for: earthed-neutral systems, overvoltage category I to III, pollution degree 3 (standard-industry): U_{imp} = 4kV.

3) Maximum cable cross-section with prepared conductor

4) AC7b motor 2-pole 230V 1,1kW

5) Rated frequency 50/60Hz

6) Max. occ. switching overvoltage <4kV

7) Duty cycle: 100%

Modular Contactors

Dimensions

R20-..., R25-... (2-pole)
RC-R 230, RH25-20

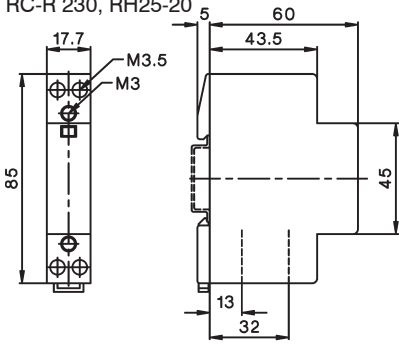

R25-TN

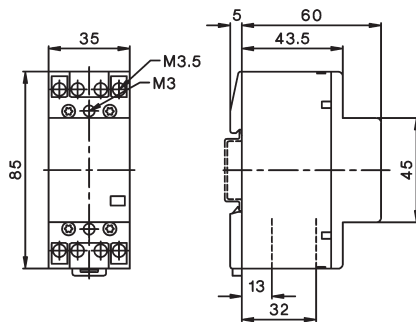

R25-... (4-pole) (+RH11)
R25-...VM (+RH11-1)

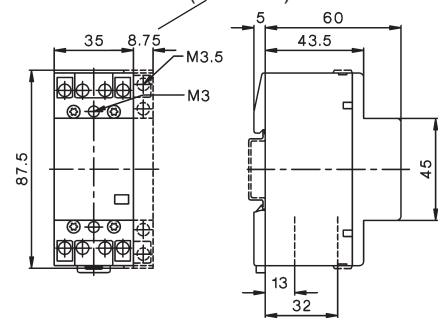

R40-... (2-pole)
R63-... (2-pole)

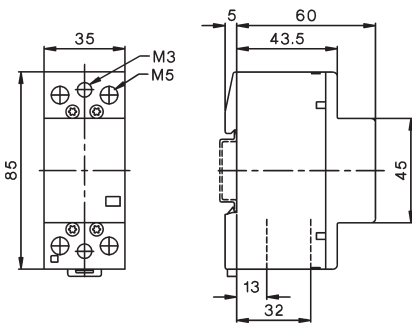

R40-... (4-pole) (+RH11)
R63-... (4-pole) (+RH11)

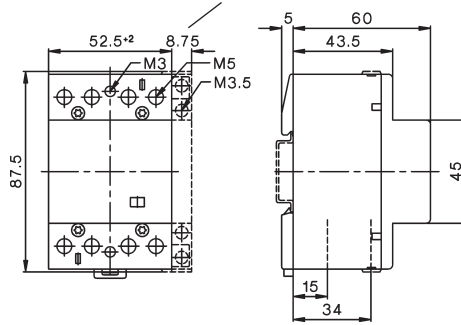

Aux. contact block
RH11, RH11-1

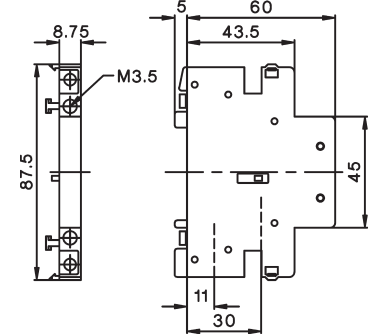

Contactors for DC-Switching

AC-operated



Rated Operational Current DC1			Additional Aux. Contacts	Type	Coil voltage ¹⁾ 230 ↓ 220-230V 50Hz, 240V 60Hz	Pack pcs.	Weight kg/pc.	Wiring diagram
600V	1000V	1200V						
20A	-	-	2 HKA11	K3DC-20A00 ...		1	0,5	
50A	-	-	+1 HKT.	K3DC-48A00 ...		1	0,5	
60A	30A	-	2 HKA11	K3DC-60A00...		1	1,2	
80A	60A	-	+1 HKT.	K3DC-80A00 ...		1	1,2	
100A	-	-		K3DC-100A00 ...		1	1,8	
12A	12A	6A	2 HKA11 +2 HKT.	K3PV-12A00 ...		1	0,8	
30A	30A	-	2 HKA11	K3PV-30A00 ...		1	0,9	
60A	60A	-	+2 HKT.	K3PV-60A00 ...		1	0,9	
80A	80A	-	2 HKA11	K3PV-80A00 ...		1	1,5	
100A	100A	-	+1 HKT.	K3PV-100A00 ...²⁾		1	2,3	
150A	150A	-	2 HKA11	K3PV-150A00 ...²⁾		1	5	
200A	200A	-	+1 HKT.	K3PV-200A00 ...²⁾		1	5	
240A	240A	-		K3PV-240A00 ...²⁾		1	5	
300A	300A	-	2 HKA11	K3PV-300A00 ...²⁾		1	7,5	
400A	400A	-	+1 HKT.	K3PV-400A00 ...²⁾		1	7,5	
450A	450A	-		K3PV-450A00 ...²⁾		1	7,5	

Contactors for DC-Switching for PV-installations, as remote controlled fire protection defeat device



In most Photovoltaic-installations, the switch disconnectors according to IEC 60364-7-712 are integrated in the DC/AC-inverter. So the wires between solar-panels and inverter are continuously under voltage. According to ÖVE-R11-1: 2013, Photovoltaic-installations must have a fire protection defeat device. For this purpose, BENEDICT contactors for DC-switching, used as a fire protection defeat device, can switch off the Photovoltaic-installation with a remote controlled fire brigade Emergency-Stop-button.

Switch diagram (4 contacts)

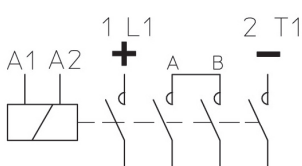

Connection diagram 1-pole

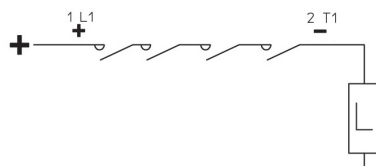

For using as two-poles contactor remove connection A-B

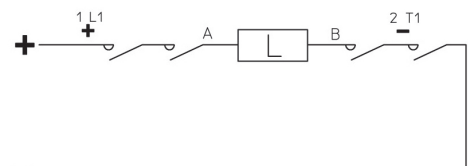

1) Other coil voltages from 24 to 600V AC, on request

2) Type for AC- and DC-operating: e.g.: 230: 220-240V 50/60Hz and 220V=

Contactors for DC-Switching

DC-operated



Type	Coil voltage ¹⁾		Aux. Contacts		Pack pcs.	Weight kg/pc.	Wiring diagram
	24	24V DC	build in NO NC	additional Type			
K3DC-20A10= ...	1	-	1	HKA11	1	0,5	
K3DC-48A10= ...	1	-	-	+1 HKT.	1	0,5	
K3DC-60A00= ...	-	-	-	1 HKA11	1	1,2	
K3DC-80A00= ...	-	-	-	+1 HKT.	1	1,2	
K3DC-100A00= ...	-	-	-	-	1	1,8	
K3PV-12A10=	1	-	1	HKA11 +2 HKT.	1	0,85	
K3PV-30A10= ...	1	-	1	HKA11	1	0,95	
K3PV-60A10= ...	1	-	-	+2 HKT.	1	0,95	
K3PV-80A00= ...	-	-	-	2 HKA11	1	1,5	
K3PV-100A00 ... ²⁾	-	-	-	+1 HKT.	1	2,3	
K3PV-150A00 ... ²⁾	-	-	-	2 HKA11	1	5	
K3PV-200A00 ... ²⁾	-	-	-	+1 HKT.	1	5	
K3PV-240A00 ... ²⁾	-	-	-	-	1	5	
K3PV-300A00 ... ²⁾	-	-	-	2 HKA11	1	7,5	
K3PV-400A00 ... ²⁾	-	-	-	+1 HKT.	1	7,5	
K3PV-450A00 ... ²⁾	-	-	-	-	1	7,5	

Auxiliary Contact Blocks for contactors K3DC-.. and K3PV-.., for low level switching⁴⁾

Rated Operational Current				Type	Pack pcs.	Weight kg/pc.	Wiring diagram
AC15	AC15	AC1	For contactors				
230V	400V	690V					
A	A	A					
3	2	10	K3DC, K3PV-.. top	HKT11	1	0,04	
3	2	10	K3DC, K3PV-.. top	HKT22	1	0,05	
3	2	10	K3DC, K3PV-.. outside	HKA11	1	0,05	
Fire Brigade-EMERGENCY STOP key operated button Ø40mm, according to EN418, unlock by key							













Accessories



1) Other coil voltages from 24 to 250V DC, on request
 2) Type for AC- and DC-operating: e.g.: 24: 24V 50/60Hz and 24V=
 3) → opener positive opening acc. IEC/EN60947-5-1
 4) Contacts suitable for electronic circuits, according to IEC60947-5-4 for rated voltage 24V DC (test ratings 17V DC, 5mA) Mirror contacts acc. IEC60947-4-1 Annex F.
 Technical data see page 78

Technical Data

Data according to IEC 60947-4-1, VDE 0660

Type		K3DC-20..	K3DC-48..	K3DC-60..	K3DC-80..	K3DC-100..	K3PV-12..	K3PV-30..	K3PV-60..	K3PV-80..	K3PV-100..	K3PV-150..	K3PV-200..	K3PV-240..	K3PV-300..	K3PV-400..	K3PV-450..				
Rated insulation voltage U_{imp}	V= kV	600 8	600 8	1000 8	1000 8	600 8	1200 8	1000 8	1000 8	1000 8	1000 8	1000 8	1000 8	1000 8	1000 8	1000 8	1000 8				
poles in series		3	3	3	3	3	8	6	6	4	4	3	3	3	3	3	3				
DC1 600V dc	I_e A	20	50	60	80	100	12	30	60	80	100	150	200	240	300	400	450				
DC1 1000V dc	I_e A	-	-	30	60	-	12	30	60	80	100	150	200	240	300	400	450				
DC1 1200V dc	I_e A	-	-	-	-	-	6	-	-	-	-	-	-	-	-	-	-				
DC3/5 310V dc	I_e A	-	-	-	40	60	-	15	24	40	90	125	170	200	230	270	300				
DC3/5 460V dc	I_e A	-	-	-	-	-	-	15	24	40	40	125	170	200	230	270	300				
DC3/5 600V dc	I_e A	-	-	-	-	-	-	-	-	-	-	50	60	75	120	160	200				
Main pole resistance	mOhm	1,8	1,8	1,4	1,2	1	2,2	1,8	1,8	1,2	1	0,5	0,5	0,35	0,15	0,15	0,15				
poles in series resistance	mOhm	5,4	5,4	4,2	3,6	3	17,6	10,8	10,8	4,8	4	1,5	1,5	1,1	0,5	0,5	0,5				
Mechanical life	10^6	10										10			8						
Protection degree		IP20										IP00 / IP20 ¹⁾			IP00 / IP20 ¹⁾						
Main poles																					
Cable cross sections	mm ²	2 x 1,5 - 10		2,5 - 35		4 - 35 +4-50	2x 1,5-2,5	2 x 1,5 - 10		2,5-35		4 - 35 +4 - 50		Busbar 18 x 4 Screw M8			Busbar 25 x 6 Screw M10				
Tightening torque	Nm	2,3 - 2,7		5 - 6		8 - 9,6		1,4 - 1,6		2,3 - 2,7		5 - 6		8 - 9,6		17 - 20			35 - 42		
Mounting		DIN-rail or screw				screws		DIN-rail or screws				Screws		Screws			Screws				
Operating range of coils	Uc	0,85 - 1,1																			
Power consumption of coils																					
AC inrush	VA	90		250		180		250		350		360									
sealed	VA/W	9 / 3		18 / 4		18 / 6		18 / 4		5 / 5		6 / 6									
DC inrush	W	120		230		230		230		350		360									
sealed	W	2		4		5		4		5		6									
Suppressor Unit																					
Coil	AC																				
x ... integrated	DC	x		x		-		-		-	x		x		x		x				
Switching time																					
AC make time	ms	10 - 25		12 - 30		12 - 30		10 - 25		12 - 30		15 - 50		30 - 60		40 - 60					
release time	ms	6 - 18		6 - 15		6 - 15		6 - 18		6 - 15		30 - 80		30 - 80		40 - 60					
DC make time	ms	15 - 25		15 - 25		20 - 30		15 - 25		15 - 25		15 - 50		30 - 60		40 - 60					
release time	ms	40 - 70		10 - 25		10 - 25		40 - 70		10 - 25		30 - 80		30 - 80		40 - 60					
Maximum ambient temperature																					
Operation °C		-40 to +40 (+70) ²⁾																			
Storage °C		-40 to +70																			
Short circuit protection for contactors																					
Coordination-type „1“																					
max. fuse size gPV																					
600VDC A		63	80	-	-	160	-	-	-	-	-	160	200	250	-	-	-				
1000VDC A		-	-	-	-	-	12	63	100	-	160	160	200	250	315	400	500				
Coordination-type „2“																					
max. fuse size gPV																					
600VDC A		50	63	80	100	125	-	-	-	100	-	-	-	-	-	-	-				
1000VDC A		-	-	80	100	-	-	50	80	100	125	-	-	-	-	-	-				
Short-circuit current	kA	3	3	3	3	5	3	3	3	5	5	10	10	10	10	10	10				

Data according to UL60947-4-1



Type		K3DC-20..	K3DC-48..	K3DC-60..	K3DC-80..	K3PV-80..	K3PV-150..	K3PV-200..	K3PV-240..	K3PV-300..	K3PV-400..	K3PV-450..
General Use I_e [A]	600V DC 1000V DC	20 -	40 -	60 30	80 60	80 80	130 130	160 160	200 200	300 300	330 330	360 360
Motor Control I_e [A]	220-240V DC 500V DC 550-600V DC	12 12 12	20 16 16	38 34 38	55 51 46	72 67 61	89 83 90	106 99 111	140 123 148	173 164 185	206 205 222	255 246 294

1) IP20 w. terminal lug.

2) > 40° ... 1% / °C de-rating (eg. at 60°C 20% de-rating)

Dimensions (mm)

K3DC-20A00, K3DC-48A00

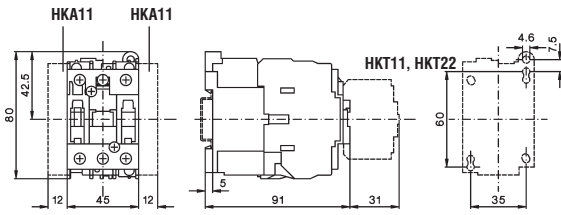

K3DC-20A10=, K3DC-48A10=

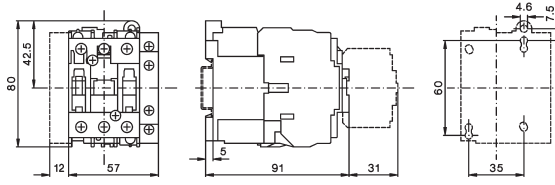

K3DC-60A00(=), K3DC-80A00(=), K3DC-100A00(=)

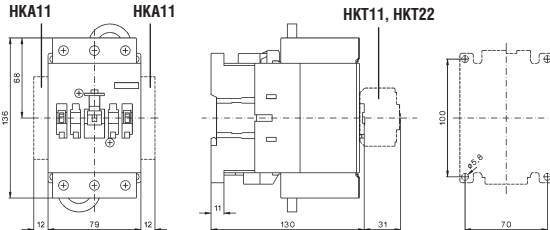
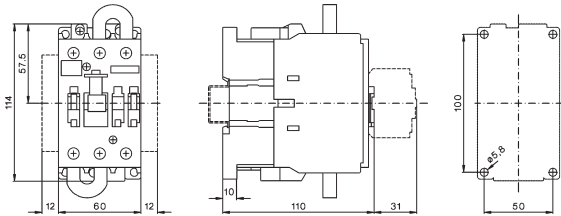

K3PV-12A00

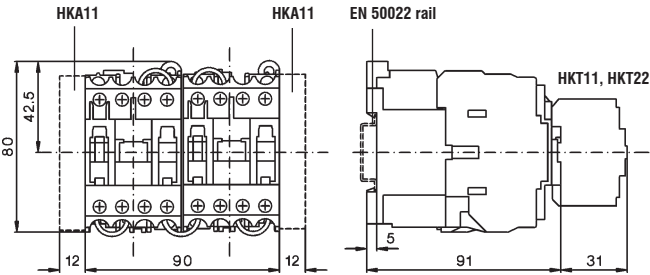

K3PV-12A10=

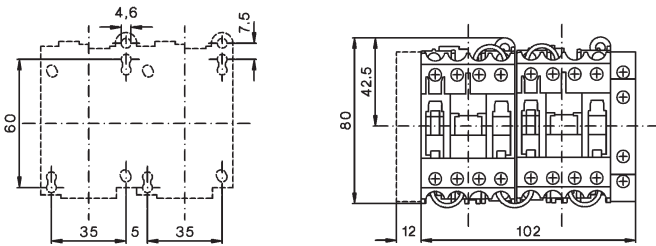

K3PV-30A00, K3PV-60A00

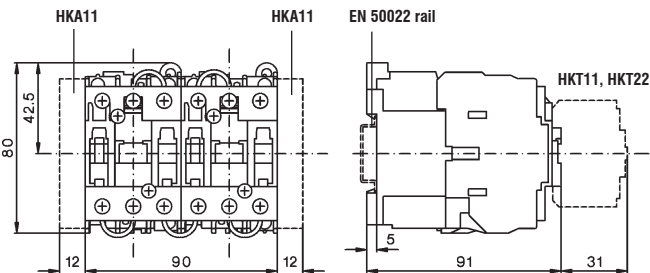

K3PV-30A10=, K3PV-60A10=

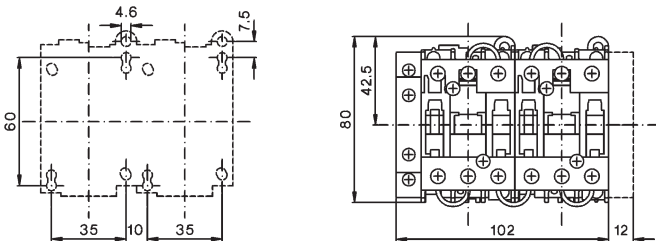

K3PV-80A00(=)

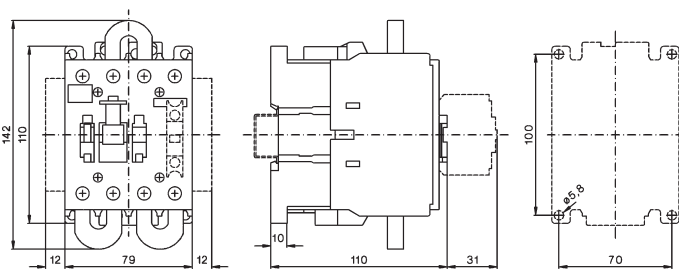

K3PV-100A00(=)

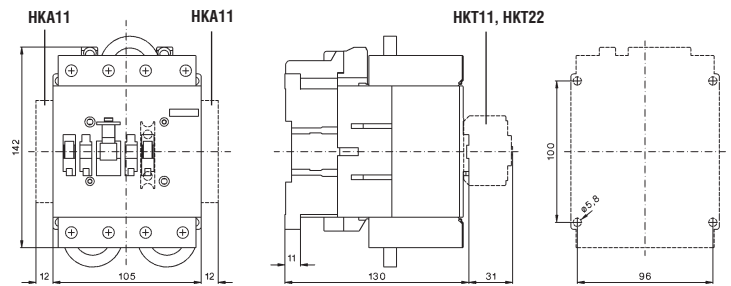

K3PV-150A00(=), K3PV-200A00(=), K3PV-240A00(=)

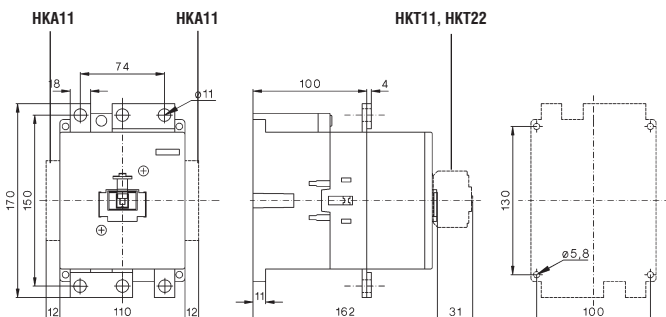

K3PV-300A00(=), K3PV-400A00(=), K3PV-450A00(=)

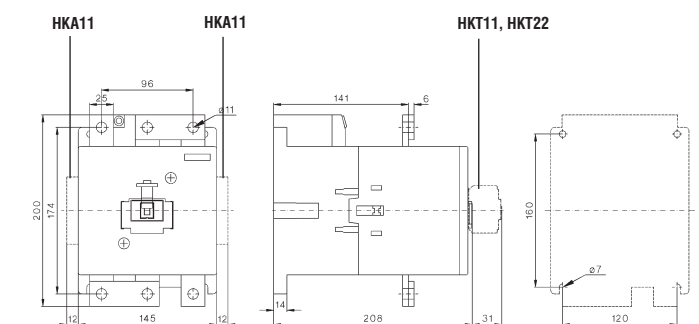

Contactors	RAST 5	147
	Contactor Relays	147
	Contactors	147

Accessories		147
	Auxilliary Contact Blocks	147

Combinations		148
	Contactors for Fuseless Load Feeder	148
	Contactors for Overload Relays	148

Industry Standard RAST 5		
	Contactor-Housing	149
	Coil-Housing	150
	Auxilliary Contact Block-Housing	157

System Stocko RAST 5		
	Contactor-Housing	151
	Coil-Housing	152
	Auxilliary Contact Block-Housing	158

System Tyco RAST 5		
	Contactor-Housing	153
	Coil-Housing	154
	Auxilliary Contact Block-Housing	159

System Lumberg RAST 5		
	Contactor-Housing	155
	Coil-Housing	156
	Auxilliary Contact Block-Housing	160

Dimensions / Color Codes		161
---------------------------------	--	-----

Technical Information		162
------------------------------	--	-----

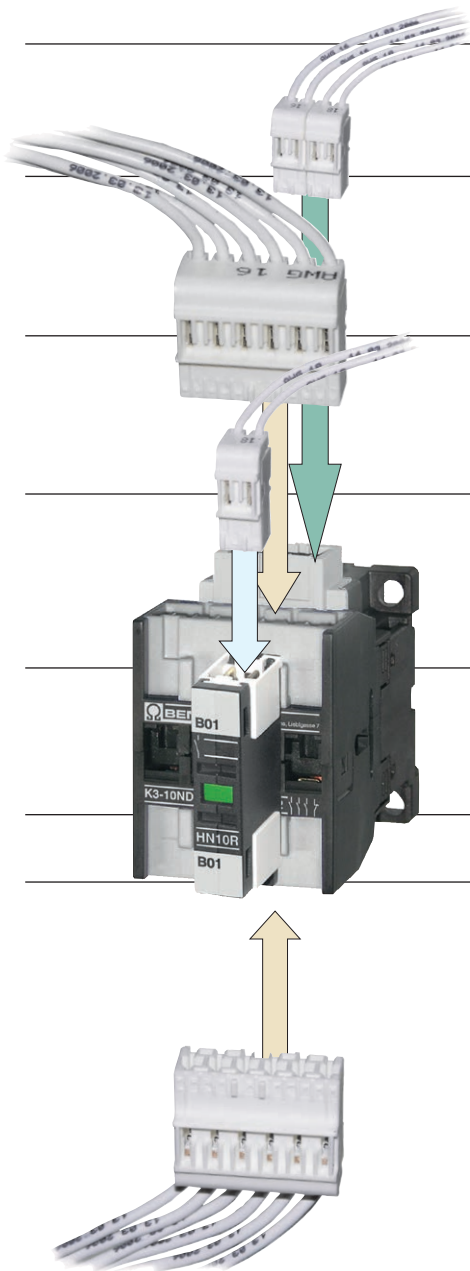

RAST 5 - exclusiv for OEM-Partner

5 mm pitch connector system

Advantages RAST 5 - Technology

- Time saving installation
- Easy assembly without tools
- Tailor-made sockets, custom - designed codes
- Ambient temperatures up to +90°C/194°F
- Smallest sizes
- Plug technology up to 32 A / 415 V
- color coding for power ratings
- color coding for coil voltages

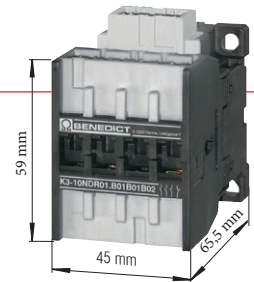

RAST 5 - Accessories



Combining switchgears with plug-in connections and screw connections

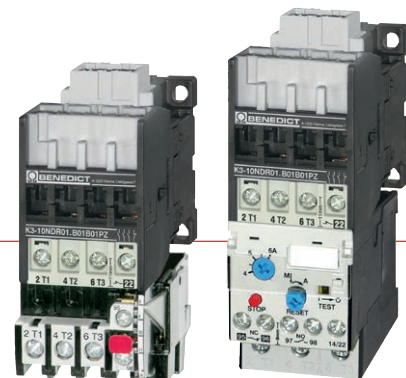





Contactors are available for plugs of many different producers



Contactors, RAST 5

AC operated

	Ratings AC2, AC3			Rated- Current	Auxilliary Contacts built in		Auxilliary Contacts snap on	Type	Coil Voltage	Code Housing Coil	Code Housing IN (L)	Code Housing OUT (T)	Pack pcs.	Weight kg/pc.
	400V	220V	240V		AC1	NO								
● Contactor Relays														
	-	-	-	10	4	-	2	K3-07NDR40					1	0,23
	-	-	-	10	2	2	2	K3-07NDR22					1	0,23
● Contactors														
	4	3	3	25	1	-	2	K3-10NDR10					1	0,23
	4	3	3	25	-	1	2	K3-10NDR01					1	0,23
	5,5	4	4	25	1	-	2	K3-14NDR10					1	0,23
	5,5	4	4	25	-	1	2	K3-14NDR01					1	0,23
	7,5	5	5	32	1	-	2	K3-18NDR10					1	0,23
	7,5	5	5	32	-	1	2	K3-18NDR01					1	0,23
	11	6	7	32	1	-	2	K3-22NDR10					1	0,23
	11	6	7	32	-	1	2	K3-22NDR01					1	0,23

Auxilliary

● Auxilliary Contact Blocks

	for Contactors	AC15 230V A	I _{th} A	Contacts		Type	Pack pcs.	Weight kg/pc.
				NO	NC			
	K3-..R..	3	10	1	-	HN10R	10	0,02
	K3-..R..	3	10	-	1	HN01R	10	0,02

Order Example for Contactors:

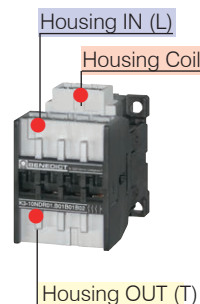
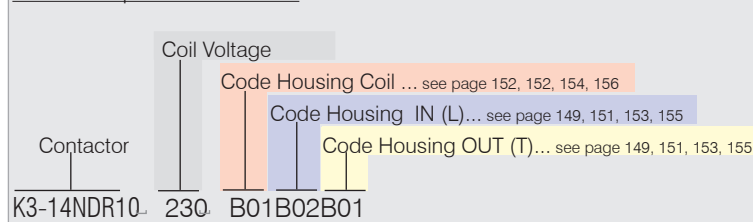

Technical data are subject to change without notice

Contactors, RAST 5 Combinations

AC operated



Motor
 AC2, AC3
 380V AC3
 400V 400V
 415V 415V
KW A for
 Overload Relays
 U12/16E.. and U3/32...

Type

Coil Voltage
 Code Housing Coil
 Code Housing IN (L)
 Screw Connection OUT (T)

Pack pcs. Weight kg/pc.

● Contactors for Overload Relays

	4	10	U12/16E 0,18-..23 K3 und U3/32 0,18-..32	K3-10NDR10	PZ	1	0,23
	4	10	U12/16E 0,18-..23 K3 und U3/32 0,18-..32	K3-10NDR01	PZ	1	0,23
	5,5	14	U12/16E 0,18-..23 K3 und U3/32 0,18-..32	K3-14NDR10	PZ	1	0,23
	5,5	14	U12/16E 0,18-..23 K3 und U3/32 0,18-..32	K3-14NDR01	PZ	1	0,23
	7,5	18	U12/16E 0,18-..23 K3 und U3/32 0,18-..32	K3-18NDR10	PZ	1	0,23
	7,5	18	U12/16E 0,18-..23 K3 und U3/32 0,18-..32	K3-18NDR01	PZ	1	0,23
	11	22	U12/16E 0,18-..23 K3 und U3/32 0,18-..32	K3-22NDR10	PZ	1	0,23
	11	22	U12/16E 0,18-..23 K3 und U3/32 0,18-..32	K3-22NDR01	PZ	1	0,23

Pozidriv . . . PZ
 Torx TX

Selection of Contactor-Housings for Standard plugs acc. **Industry Standard RAST 5**

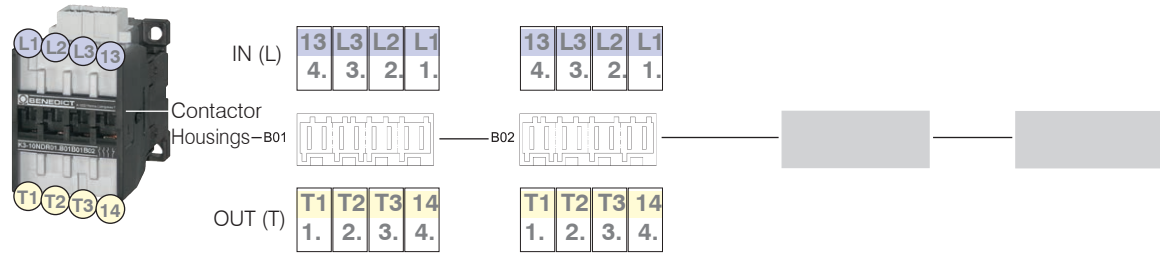

Code Contactor-Housings — B01 — B02 — B03 — B04 — further housings on request →

Standard plugs acc. Industry Standard RAST 5



	B01	B02	B03	B04
8-pole				
6-pole left				
6-pole right				
4-pole left	-0A-			
4-pole right		-0B-		
2-pole left		-0A- -0C- -0I- -0L-		
2-pole center left	-0A- -0C-	-0K-		
2-pole center right		-0B- -0F- -0K- -0L-		
2-pole right			-0I- -0L-	

Order Example for Contactors:

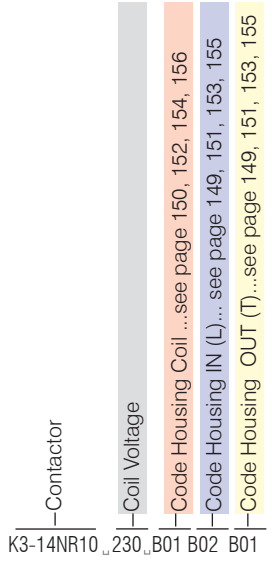

Selection of Coil-Housings for Standard plugs acc. **Industry Standard RAST 5**



Coil-Housings - B01

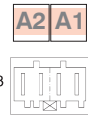
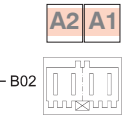
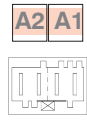

Code Coil-Housings

B01

B02

B03

B04

B05

further housings on request →

Standard plugs acc. Industry Standard RAST 5

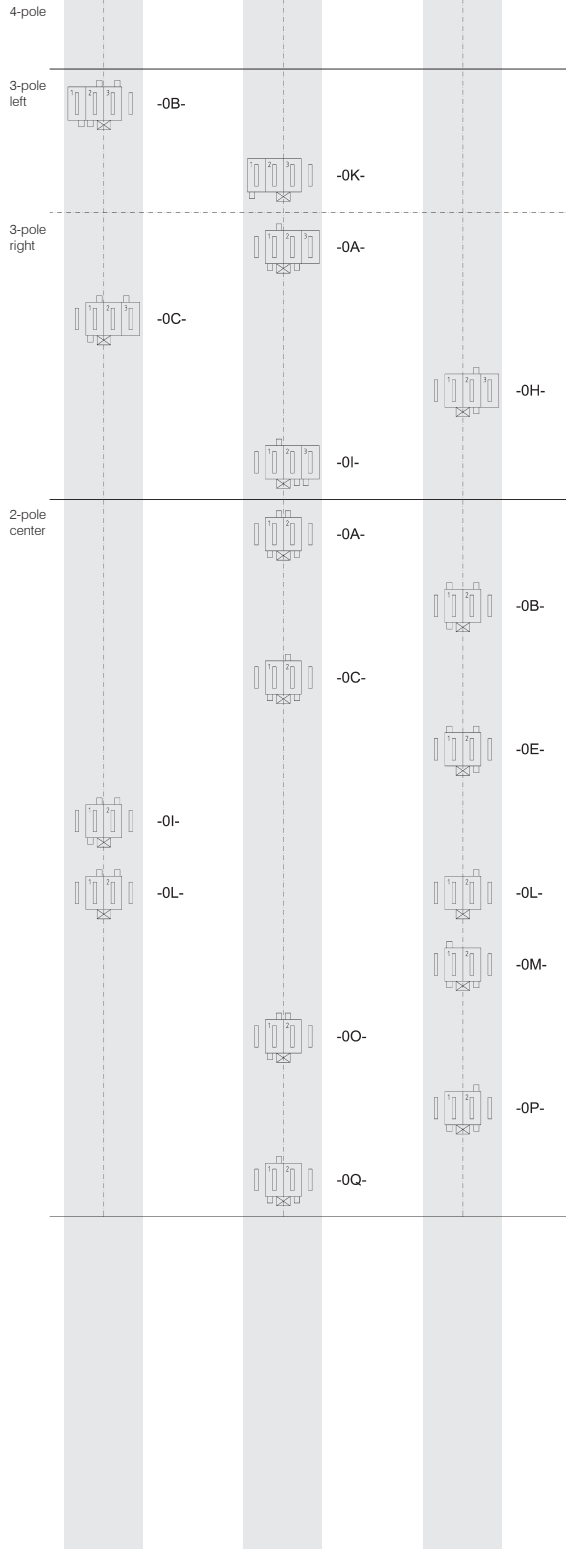

Selection of Contactor-Housings for Standard plugs acc. **System Stocko RAST 5**

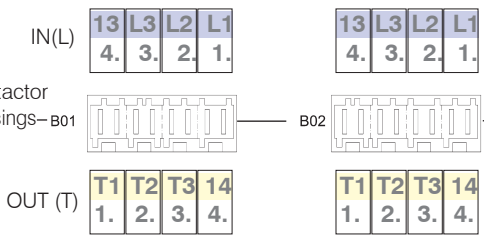

Code Contactor-Housings — B01 — B02 — B03 — B04 — further housings on request →

Standard plugs acc. System Stocko RAST 5



Pole Configuration	B01	B02	Code
8-pole	[Diagram]	[Diagram]	-31-
6-pole left	[Diagram]	[Diagram]	-34-
	[Diagram]	[Diagram]	-35-
	[Diagram]	[Diagram]	-38-
	[Diagram]	[Diagram]	-50-
	[Diagram]	[Diagram]	-65-
	[Diagram]	[Diagram]	-1F-
6-pole right	[Diagram]	[Diagram]	-34-
	[Diagram]	[Diagram]	-35-
	[Diagram]	[Diagram]	-38-
	[Diagram]	[Diagram]	-50-
	[Diagram]	[Diagram]	-65-
	[Diagram]	[Diagram]	-1F-
4-pole left	[Diagram]	[Diagram]	-14-
	[Diagram]	[Diagram]	-16-
	[Diagram]	[Diagram]	-53-
	[Diagram]	[Diagram]	-60-
	[Diagram]	[Diagram]	-73-
	[Diagram]	[Diagram]	-75-
4-pole right	[Diagram]	[Diagram]	-10-
	[Diagram]	[Diagram]	-60-
2-pole	see... Industry Standard RAST 5		

Order Example for Contactors:

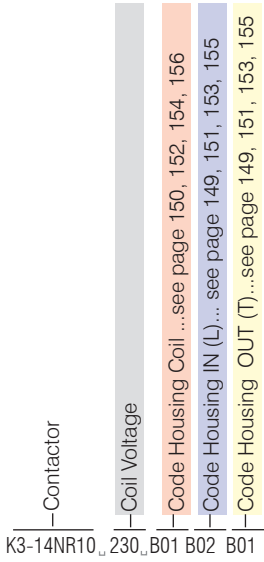

Selection of Coil-Housings for Standard plugs acc. **System Stocko RAST 5**



Coil-Housings –

B01

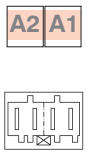
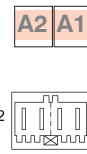
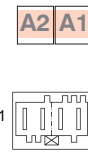
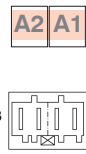
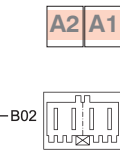
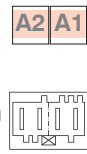

Code Coil-Housings

**Standard plugs
acc.
System Stocko RAST 5**

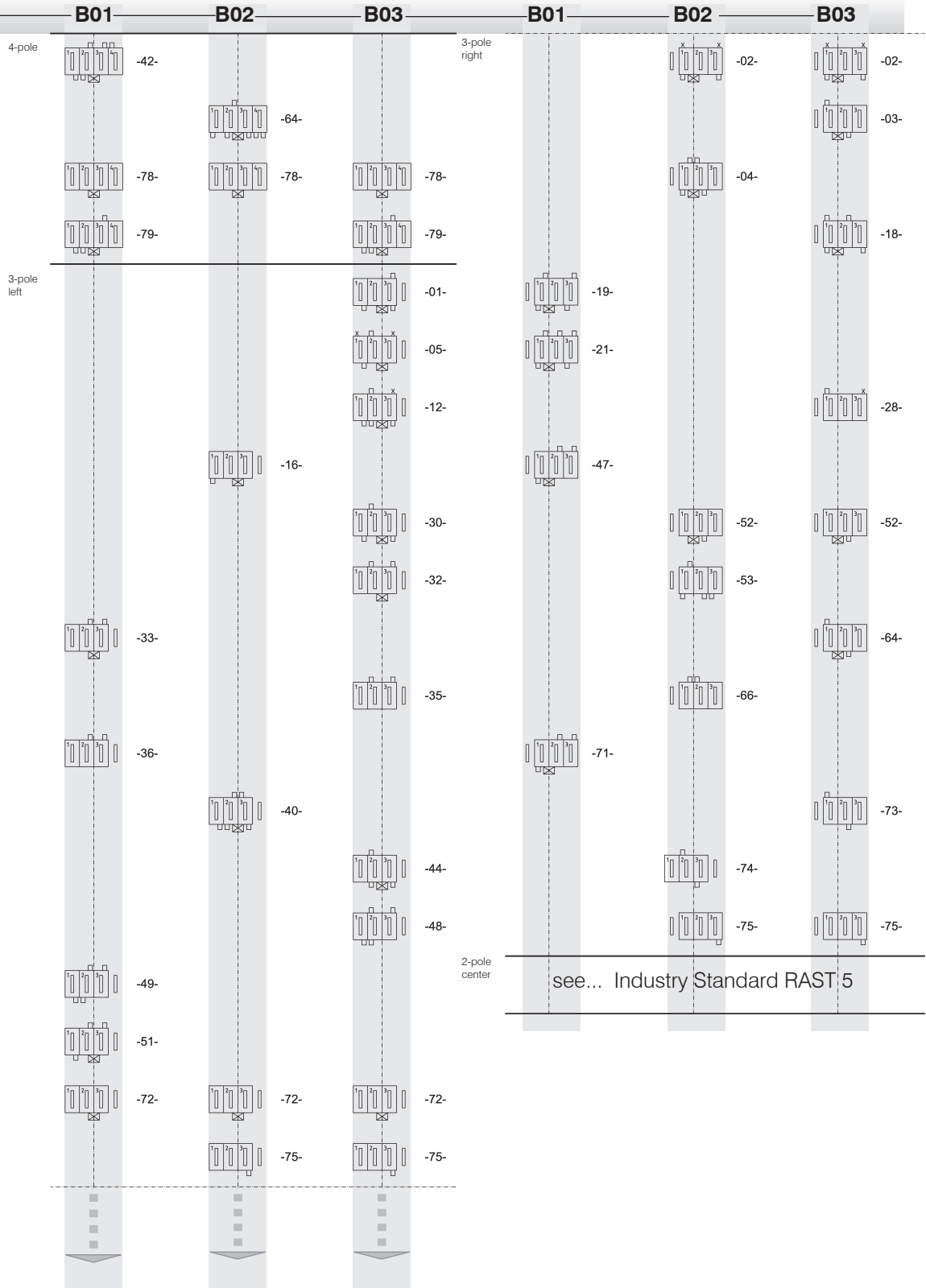

see... Industry Standard RAST 5

Selection of Contactor-Housings for Standard plugs acc. **System Tyco RAST 5**

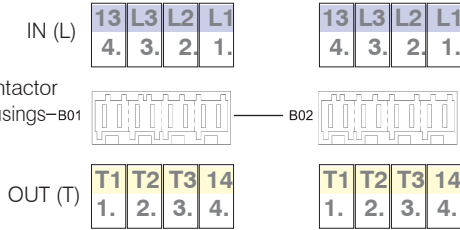

Code Contactor-Housings — **B01** — **B02** — **B03** — **B04** — further housings on request →

Standard plugs acc. System Tyco RAST 5



Order Example for Contactors:

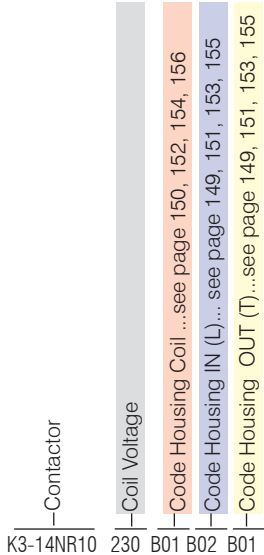

	B01	B02	B03	B04
4-pole				
6-pole left		928151-6		
		2-928344-6		
6-pole right				
4-pole left	928344-4			
			4-928344-4	
4-pole right				
2-pole left			928344-2	
			3-964951-2	
	2-964951-2			
	928343-2			
			964951-2	
			4-928344-2	
2-pole center left	928344-2			
		3-964951-2		
		4-928344-2		
2-pole center right			2-928344-2	
			928343-2	
2-pole right		2-928344-2		
			2-964951-2	
		928343-2		928343-2

Selection of Coil-Housings for Standard plugs acc. **System Tyco RAST 5**



Coil
Housings –

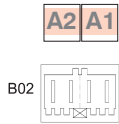

Code Coil-Housings

B01

B02

B03

B04

B05

further housings
on request →

**Standard plugs
acc.
System Tyco RAST 5**

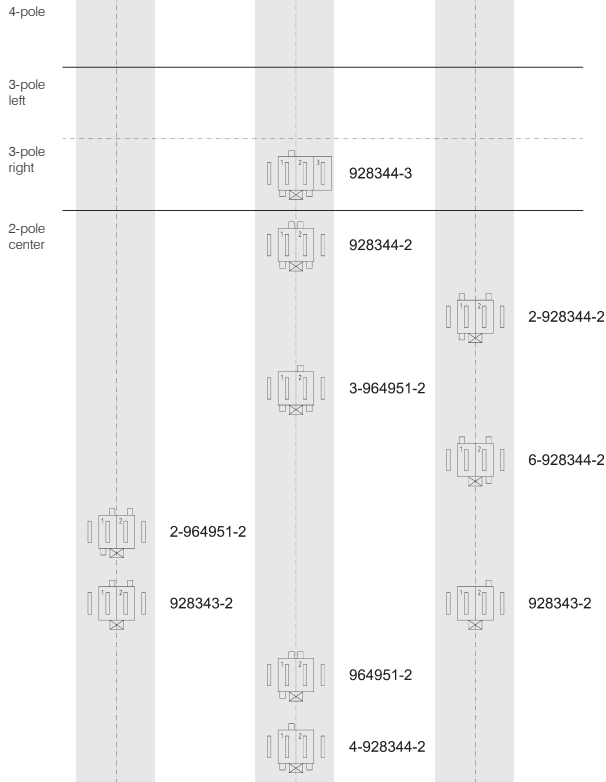

Selection of Contactor-Housings for Standard plugs acc. **System Lumberg RAST 5**

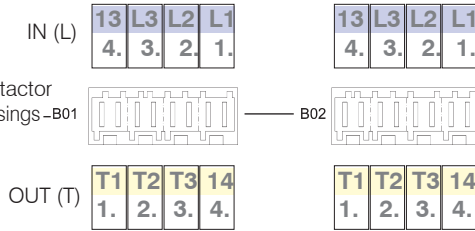

Code Contactor-Housings — B01 — B02 — B03 — B04 — further housings on request →

**Standard plugs
acc.
System Lumberg RAST 5**



	B01	B02	B03	B04
8-pole				
6-pole left		-10-		
6-pole right				
4-pole left	-01-			
4-pole right		-02-	-02-	
2-pole left		-01-	-03-	
	-09-			
2-pole center left	-01-	-03-		
		-10-		
2-pole center right		-02-	-06-	
		-09-		
2-pole right		-02-	-06-	-09-

Order Example for
Contactors:

Contactor	K3-14NR10
Coil Voltage	230V
Code Housing Coil ...see page 150, 152, 154, 156	B01
Code Housing IN (L) ... see page 149, 151, 153, 155	B02
Code Housing OUT (T) ...see page 149, 151, 153, 155	B01

Selection of Coil-Housings for Standard plugs acc. **System Lumberg RAST 5**



Coil
Housings – B01



— B02

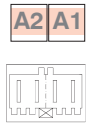

— B03



Code Coil-Housings

B01

B02

B03

B04

B05

further housings
on request →

**Standard plugs
acc.
System Lumberg RAST 5**



	B01	B02	B03
4-pole			
3-pole left			
3-pole right		-01-	
2-pole center		-01-	-02-
		-03-	-05-
	-09-		

Selection of Auxiliary Contact Block-Housings for Standard plugs acc. **Industry Standard RAST 5**



Auxiliary Contact Block-Housings

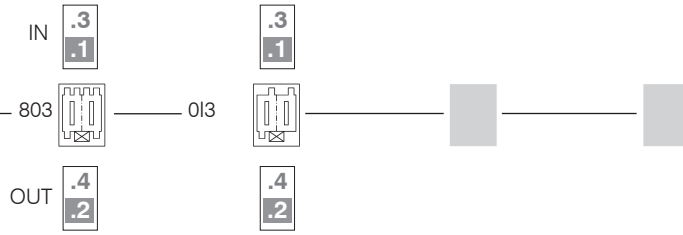

Code Auxiliary-Contact Block-Housings

2-pole

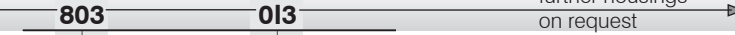

Standard plugs acc. Industry Standard RAST 5

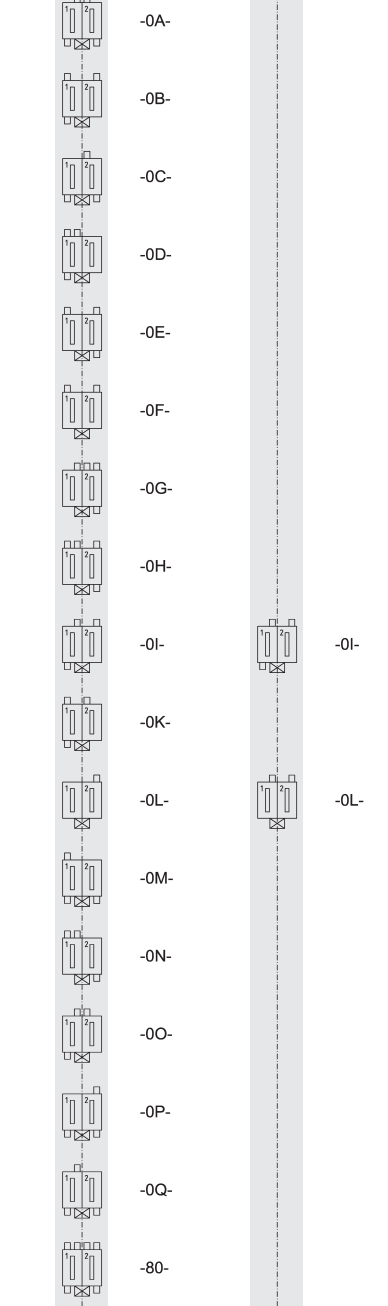

Order Example for Aux. Contact Blocks:

- Auxiliary Contact Block
 - Code Aux. Block Housing IN (1,3)
 - Code Aux. Block Housing OUT (2,4)
- HN10R.803013

Selection of Auxiliary Contact Block-Housings for Standard plugs acc. **System Stocko RAST 5**

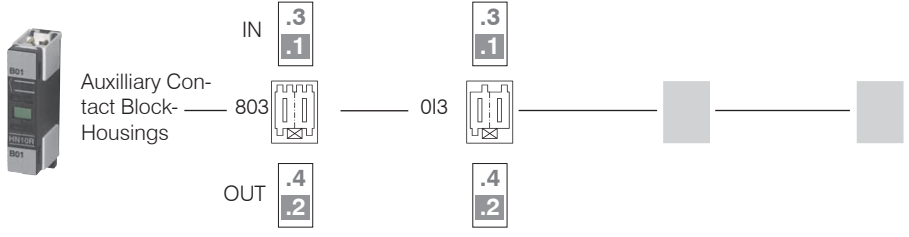

Code Auxilliary-Contact Block-Housings

Standard plugs
acc.
System Stocko RAST 5

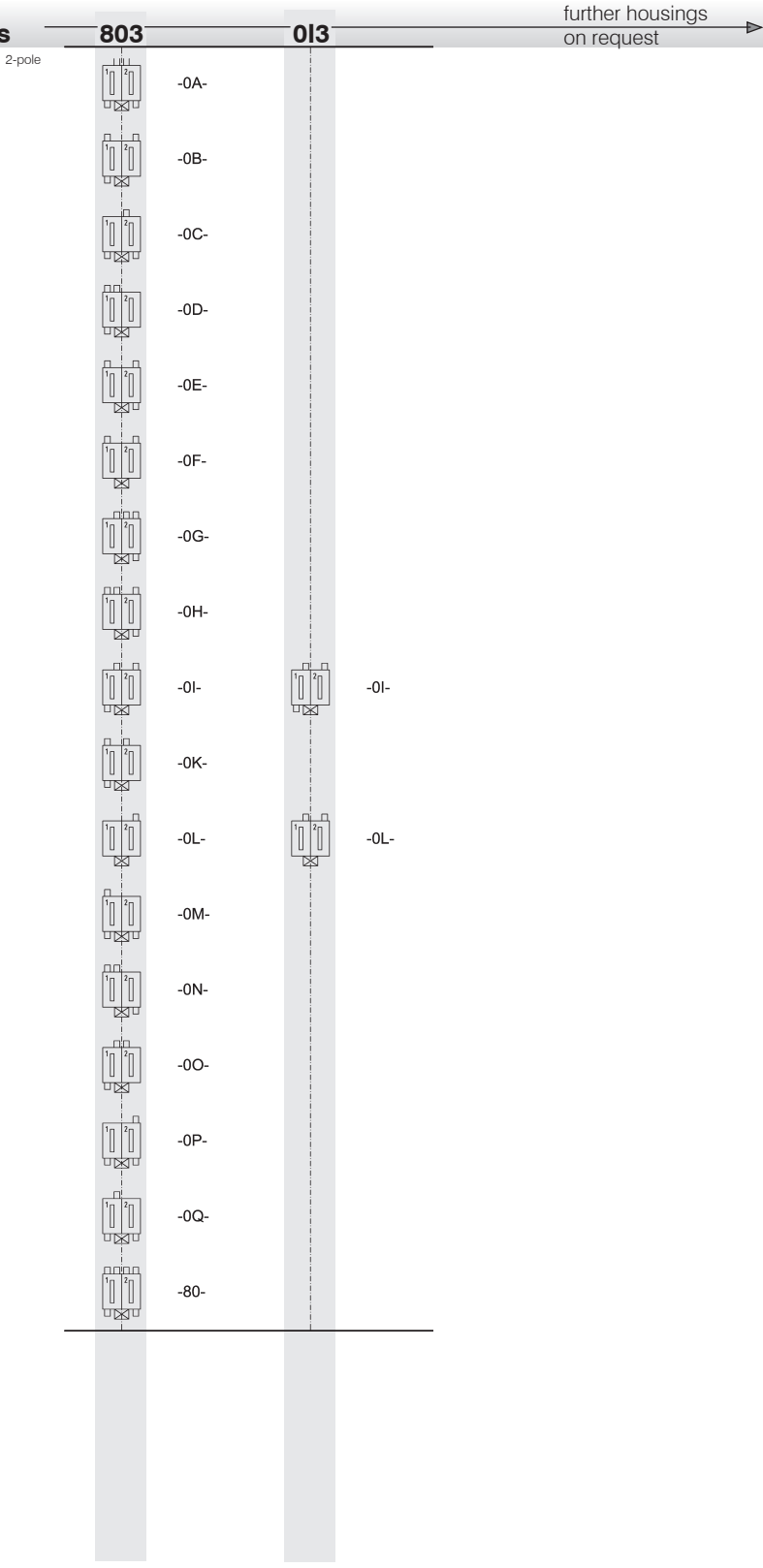

Order Example for
Aux. Contact Blocks:

- Auxiliary Contact Block
 - Code Aux. Block Housing IN (1, 3)
 - Code Aux. Block Housing OUT (2, 4)
- HN10R..803013

Selection of Auxiliary Contact Block-Housings for Standard plugs acc. **System Tyco RAST 5**

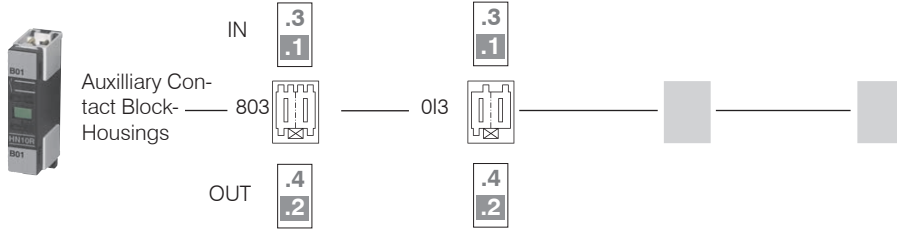

Code Auxiliary-Contact Block-Housings



Standard plugs
acc.
System Tyco RAST 5



Code	803	013
928344-2		
2-928344-2		
3-964951-2		
6-928344-2		
5-928344-2		
3-928344-2		
2-964951-2		
928343-2		
964951-2		
4-928344-2		

Order Example for
Aux. Contact Blocks:

- Auxiliary Contact Block
 - Code Aux. Block Housing IN (1, 3)
 - Code Aux. Block Housing OUT (2, 4)
- HN10R.803013

Selection of Auxiliary Contact Block-Housings for Standard plugs acc. **System Lumberg RAST 5**

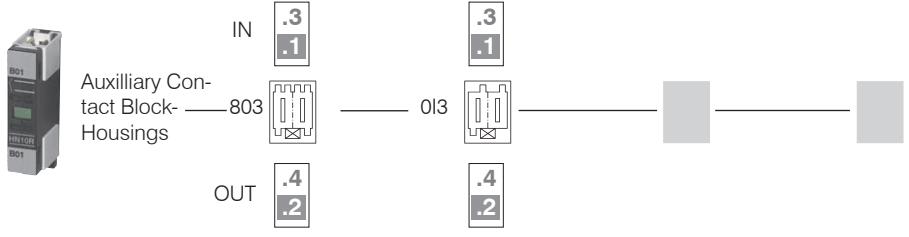

Code Auxiliary-Contact Block-Housings



Standard plugs
acc.
System Lumberg RAST 5

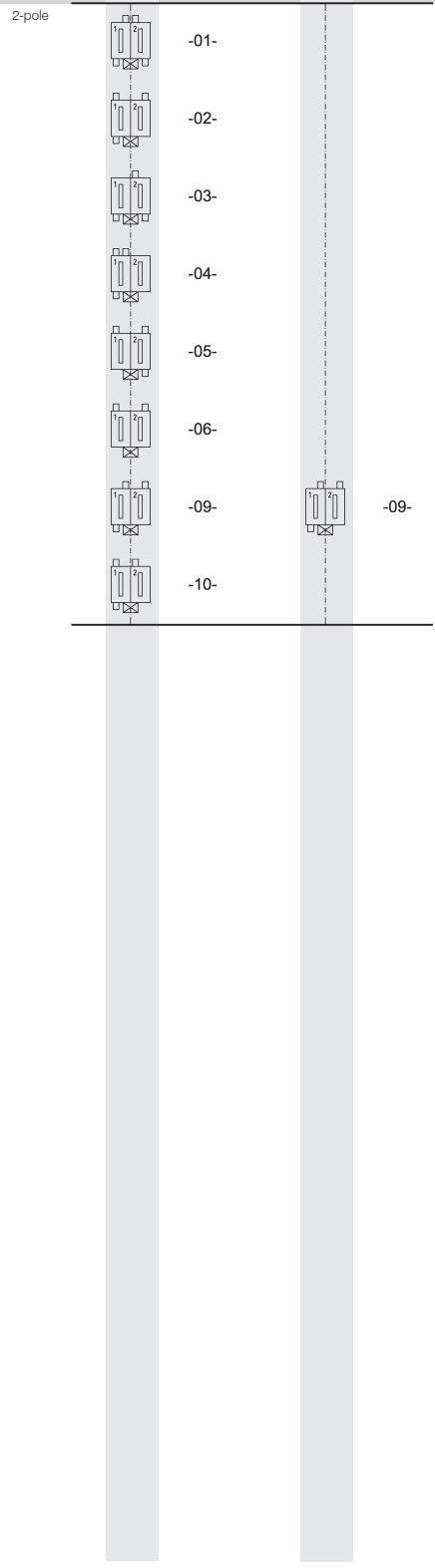

Order Example for
Aux. Contact Blocks:

- Auxiliary Contact Block
 - Code Aux. Block Housing IN (1, 3)
 - Code Aux. Block Housing OUT (2, 4)
- HN10R..803013

Dimensions

K3..NDR.. +HN..R

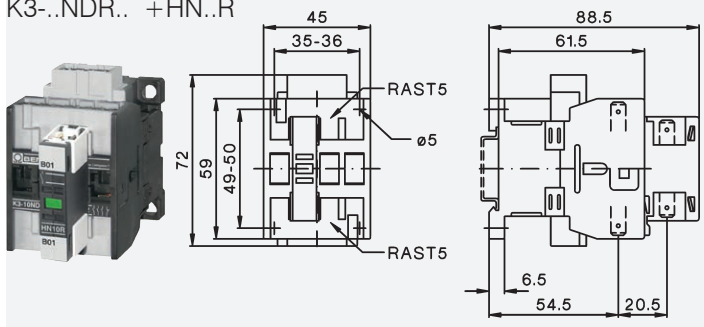

K3..NDR.....PZ + U3/32..

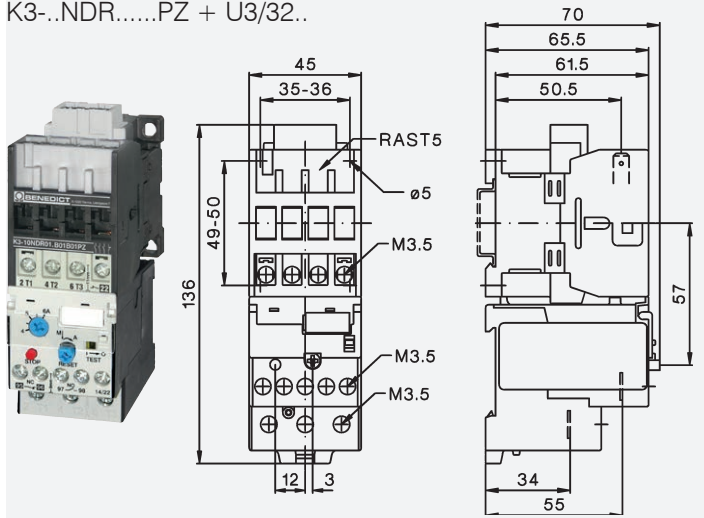

K3..NDR.....PZ + U12/16E.. K3

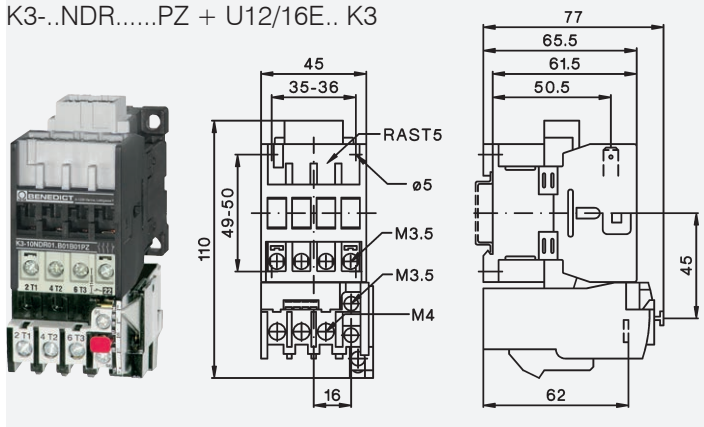

Technical data are subject to change without notice

Data acc. to IEC 60947-4-1, VDE 0660

Main Contacts	Type	K3-07NDR	K3-10NDR	K3-14NDR	K3-18NDR	K3-22NDR	
Rated insulation voltage U_i ¹⁾	V~	415	415	415	415	415	
Making capacity I_{eff} at $U_e = 415V\sim$	A	-	200	200	200	200	
Breaking capacity I_{eff} at $U_e = 415V\sim$ $\cos\varphi = 0,65$	A	-	180	180	200	200	
Utilization category AC1							
Switching of resistive load							
Rated operational current $I_e (=I_{th})$ at 40°C, open	415V	A	10	25	25	32	32
Rated operation power of three-phase resistive loads 50-60Hz, $\cos\varphi = 1$	220V	kW	-	9,5	9,5	12,2	12,2
	230V	kW	-	9,9	9,9	12,7	12,7
	240V	kW	-	10,4	10,4	13,3	13,3
	380V	kW	-	16,4	16,4	21,0	21,0
	400V	kW	-	17,3	17,3	22,1	22,1
	415V	kW	-	17,9	17,9	23,0	23,0
Rated operational current $I_e (=I_{th})$ at 60°C, enclosed	415V	A	6	25	25	32	32
Rated operational power of three-phase resistive loads 50-60Hz, $\cos\varphi = 1$	220V	kW	-	9,5	9,5	12,2	12,2
	230V	kW	-	9,9	9,9	12,7	12,7
	240V	kW	-	10,4	10,4	13,3	13,3
	380V	kW	-	16,4	16,4	21,0	21,0
	400V	kW	-	17,3	17,3	22,1	22,1
	415V	kW	-	17,9	17,9	23,0	23,0
Minimum cross-section of conductor at load with $I_e (=I_{th})$	mm ²		2 x 1,5 ²	2 x 1,5 ²	2 x 1,5 ²	2 x 2,5 ²	2 x 2,5 ²
Utilization category AC2 and AC3							
Switching of three-phase motors							
Rated operational current I_e open and enclosed	220V	A	-	12	15	18	22
	230V	A	-	11,5	14,5	18	22
	240V	A	-	11	14	18	22
	380-400V	A	-	10	14	18	22
	415V	A	-	9	14	18	22
Rated operational power of three-phase motors 50-60Hz	220-230V	kW	-	3	4	5	6
	240V	kW	-	3	4	5	7
	380-400V	kW	-	4	5,5	7,5	11
	415V	kW	-	4,5	6	8,5	12
Auxilliary Contacts							
Rated insulation voltage U_i	V~	415	415	415	415	415	
Thermal rated current I_{th} up to 415V							
Ambient temperature	40°C	A	10	10	10	10	
	60°C	A	6	6	6	6	
Utilization category AC15							
Rated operational current I_e	220-240V	A	3	3	3	3	
	380-415V	A	2	2	2	2	
Utilization category DC13							
Rated operational current I_e	60V	A	3,5	3,5	3,5	3,5	
	110V	A	0,5	0,5	0,5	0,5	
	220V	A	0,1	0,1	0,1	0,1	
Short circuit protection							
gL (gG)	A	20	20	20	20	20	

1) Suitable for: earthed -neutral systems, overvoltage category I to III, pollution degree 3 (Industry-Standard); $U_{imp} = 4kV$.

Data for other conditions on request.

Data acc. to IEC 60947-4-1, VDE 0660

Main Contacts Type **K3-07NDR** **K3-10NDR** **K3-14NDR** **K3-18NDR** **K3-22NDR**

Maximum ambient temperature

Operation	open	°C	-40 up to +60 (+90) ¹⁾				
	enclosed	°C					
with thermal overload relay	open	°C	-25 up to +60				
	enclosed	°C					
Storage		°C	-25 up to +40				
		°C					

Short circuit protection

for contactors without thermal overload relay

Coordination-Type „1“ acc. to IEC 947-4-1,
Contact welding without hazard of persons

max. fuse size	gL (gG)	A	20	63	63	63	63
----------------	---------	---	----	----	----	----	----

Coordination-Type „2“ acc. to IEC 947-4-1,
light Contact welding accepted

max. fuse size	gL (gG)	A		25	35	35	35
----------------	---------	---	--	----	----	----	----

Contact welding not accepted

max. fuse size	gL (gG)	A		16	16	16	16
----------------	---------	---	--	----	----	----	----

for Contactors with thermal overload relay the device with the smaller admissible backup fuse (contactor or thermal overload relay) determines the fuse size.

Frequency of operations z

Contactors without thermal overload relay							
	without load	1/h	10000	10000	10000	10000	10000
	AC3, I _e	1/h		600	600	600	600
	AC4, I _e	1/h		120	120	120	120
	DC3, I _e	1/h		600	600	600	600

Mechanical life

AC-operated		S x 10 ⁶	10	10	10	10	10
DC-operated		S x 10 ⁶	10	10	10	10	10

Short time current	10sec.-current	A		96	120	144	176
---------------------------	----------------	---	--	----	-----	-----	-----

Power loss per pole	at I _e /AC3 400V	W		0,21	0,35	0,5	0,75
----------------------------	-----------------------------	---	--	------	------	-----	------

Resistance to shock acc. to IEC 68-2-27

Shock time 20ms sine-wave	NO	g			10	
	NC	g			6	

Control Circuit

Power consumption of coils

AC operated	inrush	VA	33-45										
		sealed						VA	7-10				
		W						2,6-3					
DC operated	inrush	W	75										
		sealed						W	2				

Operating range of coils

in multiples of control voltage U_s

AC operated	0,85-1,1
DC operated	0,8-1,1

Switching time at control voltage U_s ± 10%^{2) 3)}

AC operated	make time	ms	8-16				
	release time	ms	5-13				
	arc duration	ms	10-15				
DC operated	make time	ms	8-12				
	release time	ms	8-13				
	arc duration	ms	10-15				

1) With reduced control voltage range 0,9 bis 1,0 x U_s and with reduced rated current I_e/AC1 acc. to I_e/AC3

2) Total breaking time = release time + arc duration

3) Values for delay of the release time of the make contact and the make time of the break contact will be increased, if magnet coils are protected with coil suppressor (Varistor, RC-Unit, Diode-Unit).

Data acc. to UL508

Main Contacts (cULus)		Type	K3-10NDR	K3-14NDR	K3-18NDR	K3-22NDR
Rated operational current „General Use“		A	25	25	30	30
Motor DOL 3-phase at 60Hz						
Rated operational current	415V	A	10	14	18	22
Rated operational power	110-120V	hp	1½	2	2	3
	200-208V	hp	3	3	5	5
	220-240V	hp	3	3	5	5
	265-277V	hp	3	5	7½	7½
	380-415V	hp	5	5	10	10
Motor DOL 1-phase at 60Hz						
Rated operational current	415V	A	10	14	18	22
Rated operational power of AC motor at 60Hz (1ph)	110-120V	hp	½	¾	1	1½
	200-208V	hp	1	1½	2	3
	220-240V	hp	1½	2	3	3
	265-277V	hp	2	3	3	3
	380-415V	hp	3	3	5	5
Fuses		A	30	40	50	50
Suitable for use on a capability of delivering not more than (SCCR)	rms	A	5000	5000	5000	5000
		V	415	415	415	415
Auxilliary Contacts (cULus)			A300	A300	A300	A300

Accessories

Data acc. to IEC 60947-5-1, VDE 0660

Auxilliary Contacts		Type	HN10R	HN01R
Rated insulation voltage U_i		V~	415	415
Thermal rated current I_{th} up to 415V				
Ambient temperature	max. 40°C	A	10	10
	max. 60°C	A	6	6
Frequency of operations z		1/h	3000	3000
Mechanical life		$S \times 10^6$	10	10
Power loss per pole at $I_{\Delta}/AC1$		W	0,5	0,5
Utilization category AC15				
Rated operational current I_e	220-240V	A	3	3
	380-415V	A	2	2
Utilization category DC13				
Rated operational current I_e	60V	A	2	2
	110V	A	0,4	0,4
	220V	A	0,1	0,1
Short circuit protection				
short circuit current 1kA, contact welding not accepted				
max. fuse size	gL (gG)	A	20	20

Data acc. to UL508

Rated operational current „General Use“		A	10	10
Rated operational voltage	max.	V~	300	300
Auxiliary Contacts			A300	A300



Circuit-Breakers M4
for motor protection

166



Auxiliary contacts
Signalling switch
Auxiliary releases

167

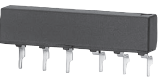

Insulated 3-pole busbar system
Terminal block

168



DIN-rail adapters
Busbar adapters
Link modules

169



Technical Data

171



Characteristics
Installation Accessories

176

178

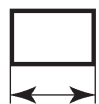

Dimensions

182

Circuit Breakers M4 for Motor Control

Rated Current I_n A	Suitable for motors ¹⁾ 3~400V kW	Setting range Thermal Overload Release A	Instantaneous Short Circuit Release A	Short Circuit Breaking Capacity at 3~400V kA (I_{cu})	Type	Pack pcs.	Weight approx. kg/pc.
-----------------------------	---	---	--	--	------	-----------	-----------------------

Circuit Breaker M4-32T-..



switch type

0,16	-	0,10	-	0,16	2,1	100	M4-32T-0,16	1	0,32
0,25	0,06	0,16	-	0,25	3,3	100	M4-32T-0,25	1	0,32
0,4	0,09	0,25	-	0,4	5,2	100	M4-32T-0,4	1	0,32
0,63	0,18	0,4	-	0,63	8,2	100	M4-32T-0,63	1	0,32
1	0,25	0,63	-	1	13	100	M4-32T-1	1	0,32
1,6	0,55	1	-	1,6	20,8	100	M4-32T-1,6	1	0,32
2,5	0,75	1,6	-	2,5	32,5	100	M4-32T-2,5	1	0,32
4	1,5	2,5	-	4	52	100	M4-32T-4	1	0,32
6	2,2	4	-	6	78	100	M4-32T-6	1	0,32
8	3	5	-	8	104	100	M4-32T-8	1	0,32
10	4	6	-	10	130	50	M4-32T-10	1	0,32
13	5,5	9	-	13	169	50	M4-32T-13	1	0,32
17	7,5	11	-	17	221	20	M4-32T-17	1	0,32
22	7,5	14	-	22	286	15	M4-32T-22	1	0,32
26	11	18	-	26	338	15	M4-32T-26	1	0,32
32	15	22	-	32	416	15	M4-32T-32	1	0,32

Circuit Breaker M4-32R-..



rotary type

0,16	-	0,10	-	0,16	2,1	100	M4-32R-0,16	1	0,36
0,25	0,06	0,16	-	0,25	3,3	100	M4-32R-0,25	1	0,36
0,4	0,09	0,25	-	0,4	5,2	100	M4-32R-0,4	1	0,36
0,63	0,18	0,4	-	0,63	8,2	100	M4-32R-0,63	1	0,36
1	0,25	0,63	-	1	13	100	M4-32R-1	1	0,36
1,6	0,55	1	-	1,6	20,8	100	M4-32R-1,6	1	0,36
2,5	0,75	1,6	-	2,5	32,5	100	M4-32R-2,5	1	0,36
4	1,5	2,5	-	4	52	100	M4-32R-4	1	0,36
6	2,2	4	-	6	78	100	M4-32R-6	1	0,36
8	3	5	-	8	104	100	M4-32R-8	1	0,36
10	4	6	-	10	130	100	M4-32R-10	1	0,36
13	5,5	9	-	13	169	100	M4-32R-13	1	0,36
17	7,5	11	-	17	221	50	M4-32R-17	1	0,36
22	7,5	14	-	22	286	50	M4-32R-22	1	0,36
26	11	18	-	26	338	50	M4-32R-26	1	0,36
32	15	22	-	32	416	50	M4-32R-32	1	0,36

Circuit Breaker M4-63R-..



rotary type

26	12,5	18	-	26	338	50	M4-63R-26	1	1,0
32	15	22	-	32	416	50	M4-63R-32	1	1,0
40	18,5	28	-	40	520	50	M4-63R-40	1	1,0
50	22	34	-	50	650	50	M4-63R-50	1	1,0
63	30	45	-	63	819	50	M4-63R-63	1	1,0

Circuit Breaker M4-100R-..









rotary type

63	30	45	-	63	819	50	M4-100R-63	1	2,2
75	37	55	-	75	975	50	M4-100R-75	1	2,2
90	45	70	-	90	1170	50	M4-100R-90	1	2,2
100	-	80	-	100	1300	50	M4-100R-100	1	2,2





1) Approximate values of standard motors

Accessories

	Contacts		Rated Operational Current			Type	Pack pcs.	Weight approx. kgpc		
	NO	NC	AC15 24V A	240V A	AC1 240V A					
Transverse Auxiliary Contact Block, max. 1 pc. per circuit-breaker ¹⁾										
	1	1	3	2	5	M4 HQ11	1	0,02		
	2	-	3	2	5	M4 HQ20	1	0,02		
	-	2	3	2	5	M4 HQ02	1	0,02		
Auxiliary Contact Block for left hand side mounting, 1 or 2 pcs. per circuit-breaker ¹⁾										
	1	1	6	4	10	M4 HS11	1	0,03		
	2	-	6	4	10	M4 HS20	1	0,03		
	-	2	6	4	10	M4 HS02	1	0,03		
Alarm Switch (any tripping) for left hand side mounting, max. 1 pc. per circuit-breaker ¹⁾										
	1	1	for M4-32T, -32R		6	4	10	M4 MA11	1	0,04
	1	1	for M4-63R, -100R		6	4	10	M4 MA11 63	1	0,04
Alarm Switch (short circuit) for left hand side mounting, max. 1 pc. per circuit-breaker ¹⁾										
	1	1	6	4	10	M4 M11	1	0,04		
Operates in case of short circuit accidents that is over 20 times of the rated current of the circuit breaker.										
Undervoltage Releases for right hand side mounting, max. 1 pc. per circuit-breaker ¹⁾										
Trips the circuit-breaker when the voltage is interrupted. Prevents the motor from being restarted accidentally when the voltage is restored, suitable for EMERGENCY STOP acc. to IEC 60204										
	24V 50Hz, 28V 60Hz					M4 U24	1	0,11		
	110-127V 50Hz, 120V 60Hz					M4 U110	1	0,11		
	220-230V 50Hz, 240-260V 60Hz					M4 U230	1	0,11		
	240V 50Hz, 277V 60Hz					M4 U240	1	0,11		
	380-400V 50Hz, 440-460V 60Hz					M4 U400	1	0,11		
	415-440V 50Hz, 460-480V 60Hz					M4 U415	1	0,11		
Shunt Releases for right hand side mounting, max. 1 pc. per circuit-breaker ¹⁾										
Trips the circuit-breaker when the release coil energized.										
100% ON max. 5sec. ON										
	20-24V 50Hz, 28V 60Hz		20-70V 50/60Hz DC		M4 A24	1	0,12			
	75-127V 50Hz, 120V 60Hz		75-190V 50/60Hz DC		M4 A110	1	0,12			
	190-230V 50Hz, 240-260V 60Hz		190-330V 50/60Hz DC		M4 A230	1	0,12			
	200-240V 50Hz, 277V 60Hz		200-330V 50/60Hz DC		M4 A240	1	0,12			
	300-400V 50Hz, 440-460V 60Hz		300-500V 50/60Hz DC		M4 A400	1	0,12			
	330-440V 50Hz, 460-480V 60Hz		330-500V 50/60Hz DC		M4 A415	1	0,12			
Enclosure for circuit breaker M4 32R protection degree IP65										
	Plastic enclose with rotary operating mechanism black-grey lockable, with N- and PE-terminal space for 1 transverse and side aux. contact + release					M4 32R PFH4	1	0,53		
	Enclose with rotary operating mechanism yellow - red, lockable with N- and PE-terminal space for 1 transverse and side aux. contact + release					M4 32R PFHN4	1	0,53		

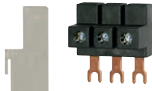

1) Number and position see page 179

Accessories and Busbars

		for circuit- breaker	Type	Pack pcs.	Weight approx. kg/pc.
	Scale cover sealable	for covering the current setting scale	M4-32...100 M4 K	10	0,003
	Push-in lugs	for screwing the circuit-breaker onto mounting plates. 2 units required (1 bag with 10 units)	M4-32 M4 32 L	10	0,01
	Spade terminal block	up to 600V acc.UL 489	M4-32R M4 32R E		on request
	Pin terminal block	up to 600V acc.UL 489	M4-32R M4 32R EV		on request
	Insulation barriers	up to 600V acc.UL 489 for increased distances and clearances acc. to UL Type "E", 2 pcs per device (on input side)	M4-100 M4 100 E	2	0,01

Door-coupling rotary mechanisms IP65



The door locking device prevents accidental opening of the cubicle door in the ON position of the circuit-breaker. The OFF position can be locked with up to 3 padlocks.

	Door-coupling rotary mechanism black	extension shaft 115mm	M4-32R M4 32R EH1 115	1	0,1
		extension shaft 315mm	M4-32R M4 32R EH1 315	1	0,2
		extension shaft 115mm	M4-63R M4 63R EH1 115	1	0,1
		extension shaft 315mm	M4-63R M4 63R EH1 315	1	0,2
		extension shaft 115mm	M4-100R M4 100R EH1 115	1	0,1
		extension shaft 315mm	M4-100R M4 100R EH1 315	1	0,2
	Emergency-Stop Door-coupling rotary mechanism; red/yellow	extension shaft 115mm	M4-32R M4 32R EHN1 115	1	0,1
		extension shaft 315mm	M4-32R M4 32R EHN1 315	1	0,2
		extension shaft 115mm	M4-63R M4 63R EHN1 115	1	0,1
		extension shaft 315mm	M4-63R M4 63R EHN1 315	1	0,2
		extension shaft 115mm	M4-100R M4 100R EHN1 115	1	0,1
		extension shaft 315mm	M4-100R M4 100R EHN1 315	1	0,2



		Protection degree	Type	Pack pcs.	Weight kg/pc.
--	--	----------------------	------	--------------	------------------

Insulated 3-phase busbar system

For feeding several modular circuit-breakers M4-32. on standard mounting rails, insulated
Rated operational voltage max. 690 V, 63 A, with **spade connection**, modular spacing 45mm (54mm on request)

	3-phase busbars	for 2 circuit-breakers	IP20 M4 32 S2	1	0,03
		for 3 circuit-breakers	IP10 M4 32 S3	1	0,05
		for 4 circuit-breakers	IP10 M4 32 S4	1	0,07
		for 5 circuit-breakers	IP10 M4 32 S5	1	0,10
	Line side terminal	Conductor cross-section solid or stranded 6-25mm ² with end sleeve 4-16mm ²	IP10 M4 32 SE	1	0,04
	Cover for tags	Touch guard for emptyspaces	M4 32 SF	1	0,003

For feeding several modular circuit-breakers M4-32. on standard mounting rails, insulated
Rated operational voltage max. 690 V, 63 A, with **pin connection**, modular spacing 45mm (54mm on request)

	3-phase busbars	for 2 circuit-breakers	IP20 M4 32 S2V	1	0,03
		for 3 circuit-breakers	IP20 M4 32 S3V	1	0,05
		for 4 circuit-breakers	IP20 M4 32 S4V	1	0,07
		for 5 circuit-breakers	IP20 M4 32 S5V	1	0,10
	Line side terminal	Conductor cross-section solid or stranded 6-25mm ² with end sleeve 4-16mm ²	IP20 M4 32 SEV	1	0,04
	Cover for tags	Touch guard for emptyspaces	M4 32 SFV	1	0,003

For feeding several modular circuit-breakers M4-63. on standard mounting rails, insulated
Rated operational voltage max. 690 V, with **pin connection**, modular spacing 55mm

	3-phase busbars	for 2 circuit-breakers	IP20 M4 63 S2	1	0,15
--	-----------------	------------------------	---------------	---	------

Mounting Parts for Fuseless Load Feeders

	Type	Pack pcs.	Weight approx. kg/pc.
DIN-rail adapters with DIN-rail for contactor			
	for M4-32.. DIN-rails moveable for easy mounting and replacing can be connected on one 35 mm DIN-rail (high 15mm) or two 35 mm-DIN-rails (125mm distance) suitable for contactors K1-..., K(G)3-10 to K(G)3-40	M4 32 HU1	1 0,1
	Adapter, for M4-63.. can be connected on two 35 mm DIN-rails (125mm distance) or one 75 mm DIN-rail, or screw mounting suitable for contactors K(G)3-24 to K(G)3-40, K3-50 to K3-74	M4 63 HU1	1 0,2
	Adapter, for M4-100.. can be connected on two 35 mm DIN-rails (125mm distance) or one 75 mm DIN-rail, or screw mounting suitable for contactors K3-50 to K3-74	M4 100 HU1	1 0,2

Busbar adapters for 60-mm-system, 3 copper busbars acc. to DIN 46433

	for M4-32 up to 25A, 690V 45mm width, 182mm long bar width: 12 und 15mm bar thickness: 5 and 10mm	M4 32 SA60	1 0,18
--	---	------------	--------

Link modules, for mechanical and electrical connection between circuit-breaker and contactor

	for M4-32.. with contactors K1-..	max. 32A	M4 32 VK1	1 0,015
	for M4-32.. with contactors K3-10 to K3-22	max. 32A	M4 32 VK3	1 0,02
	for M4-32.. with contactors KG3-10 to KG3-22	max. 32A	M4 32 VKG3	1 0,02

Link modules, for electrical connection between circuit-breaker and contactor

for M4-32.. with contactors K(G)3-24to K(G)3-40	max. 32A	M4 32 VD	1 0,01
for M4-63R. with contactors K3-24 to K3-74	max. 63A	M4 63 VD	1 0,02
for M4-63R. with contactors KG3-24 to KG3-40	max. 63A	M4 63 VDG	1 0,02
for M4-100R. with contactors K3-50 to K3-74	max. 100A	M4 100 VD	1 0,02

Components for Fuseless Load Feeders, DIN-Rail Mounting

Type of coordination "1" 3x415V 10kA ¹⁾



Motor 3~400V kW	Setting range A	Circuit-breaker page 166 Type	Link module Type	Contactor ²⁾ 220-230V 50Hz Type	DIN-rail adapter Type
-	0,10 – 0,16	M4-32T-0,16	M4 32 VK1	K1-09D10 230	-
0,06	0,16 – 0,25	M4-32T-0,25	M4 32 VK1	K1-09D10 230	-
0,09	0,25 – 0,4	M4-32T-0,4	M4 32 VK1	K1-09D10 230	-
0,18	0,4 – 0,63	M4-32T-0,63	M4 32 VK1	K1-09D10 230	-
0,25	0,63 – 1	M4-32T-1	M4 32 VK1	K1-09D10 230	-
0,55	1,0 – 1,6	M4-32T-1,6	M4 32 VK1	K1-09D10 230	-
0,75	1,6 – 2,5	M4-32T-2,5	M4 32 VK1	K1-09D10 230	-
1,5	2,5 – 4	M4-32T-4	M4 32 VK1	K1-09D10 230	-
2,2	4 – 6	M4-32T-6	M4 32 VK1	K1-09D10 230	-
3	5 – 8	M4-32T-8	M4 32 VK1	K1-09D10 230	-
4	6 – 10	M4-32T-10	M4 32 VK1	K1-09D10 230	-
5,5	9 – 13	M4-32T-13	M4 32 VK1	K1-12D10 230	-
7,5	11 – 17	M4-32T-17	M4 32 VK3	K3-18ND10 230EUR	-
7,5	14 – 22	M4-32T-22	M4 32 VK3	K3-22ND10 230EUR	-
11	18 – 26	M4-32T-26	M4 32 VK3	K3-22ND10 230EUR	-
15	22 – 32	M4-32T-32	M4 32 VD	K3-32A00 230	M4 32 HU1
-	0,10 – 0,16	M4-32R-0,16	M4 32 VK3	K3-10ND10 230EUR	-
0,06	0,16 – 0,25	M4-32R-0,25	M4 32 VK3	K3-10ND10 230EUR	-
0,09	0,25 – 0,4	M4-32R-0,4	M4 32 VK3	K3-10ND10 230EUR	-
0,18	0,4 – 0,63	M4-32R-0,63	M4 32 VK3	K3-10ND10 230EUR	-
0,25	0,63 – 1	M4-32R-1	M4 32 VK3	K3-10ND10 230EUR	-
0,55	1,0 – 1,6	M4-32R-1,6	M4 32 VK3	K3-10ND10 230EUR	-
0,75	1,6 – 2,5	M4-32R-2,5	M4 32 VK3	K3-10ND10 230EUR	-
1,5	2,5 – 4	M4-32R-4	M4 32 VK3	K3-10ND10 230EUR	-
2,2	4 – 6	M4-32R-6	M4 32 VK3	K3-10ND10 230EUR	-
3	5 – 8	M4-32R-8	M4 32 VK3	K3-10ND10 230EUR	-
4	6 – 10	M4-32R-10	M4 32 VK3	K3-10ND10 230EUR	-
5,5	9 – 13	M4-32R-13	M4 32 VK3	K3-14ND10 230EUR	-
7,5	11 – 17	M4-32R-17	M4 32 VK3	K3-18ND10 230EUR	-
7,5	14 – 22	M4-32R-22	M4 32 VK3	K3-22ND10 230EUR	-
11	18 – 26	M4-32R-26	M4 32 VK3	K3-22ND10 230EUR	-
15	22 – 32	M4-32R-32	M4 32 VD	K3-32A00 230	M4 32 HU1
12,5	18 – 26	M4-63R-26	M4 63 VD	K3-32A00 230	M4 63 HU1
15	22 – 32	M4-63R-32	M4 63 VD	K3-32A00 230	M4 63 HU1
18,5	28 – 40	M4-63R-40	M4 63 VD	K3-40A00 230	M4 63 HU1
22	34 – 50	M4-63R-50	M4 63 VD	K3-50A00 230	M4 63 HU1
30	45 – 63	M4-63R-63	M4 63 VD	K3-62A00 230	M4 63 HU1
30	45 – 63	M4-100R-63	M4 100 VD	K3-62A00 230	M4 100 HU1
37	55 – 75	M4-100R-75	M4 100 VD	K3-74A00 230	M4 100 HU1
45	70 – 90	M4-100R-90	-	K3-90A00 230	-
-	80 – 100	M4-100R-100	-	K3-115A00 230	-

1) Other conditions on request

2) Contactors K1.. 220-230V 50Hz, Contactors K3.. 220-240V 50Hz, further technical data see Catalog D677..

Technical Data according to IEC/EN 60947-1, 60947-2, 60947-4-1 and VDE 0660

This table shows the rated ultimate short-circuit breaking capacity I_{cu} and the rated service short-circuit breaking capacity I_{cs} of the M4 circuit-breakers with different operational voltages as a function of the rated current I_n of the circuit-breakers. The circuit-breakers can be fed at the top or bottom supply terminals without any reduction of the rated data.

If the short-circuit current exceeds the rated short-circuit breaking capacity of the circuit-breaker specified in the tables at the installation point, a back-up fuse is to be used. The maximum rated current for the back-up fuse is specified in the tables. These fuses are only suitable for the short-circuit-currents as indicated on the fuses.

Circuit-breaker	Rated-current I_n	up to AC 240V ²⁾			up to AC 400V ²⁾ up to AC 415V ³⁾			up to AC 440V ²⁾ up to AC 460V ³⁾			up to AC 500V ²⁾ up to AC 525V ³⁾			up to AC 690V ²⁾		
		I_{cu}	I_{cs}	max. fuse ¹⁾ (gL/gG)	I_{cu}	I_{cs}	max. fuse ¹⁾ (gL/gG)	I_{cu}	I_{cs}	max. fuse ¹⁾ (gL/gG)	I_{cu}	I_{cs}	max. fuse ¹⁾ (gL/gG)	I_{cu}	I_{cs}	max. fuse ¹⁾ (gL/gG)
Type	A	kA	kA	A	kA	kA	A	kA	kA	A	kA	kA	A	kA	kA	A
M4-32T	0,16 ... 0,63	100	100	--	100	100	--	100	100	--	100	100	--	100	100	--
	1	100	100	--	100	100	--	100	100	--	100	100	--	100	100	--
	1,6	100	100	--	100	100	--	100	100	--	100	100	--	3	3	20
	2,5	100	100	--	100	100	--	100	100	--	50	38	50	3	3	35
	4	100	100	--	100	100	--	50	38	50	15	11	40	3	3	40
	6	100	100	--	100	100	--	15	11	50	10	8	50	3	3	50
	8	100	100	--	100	100	--	15	11	63	10	8	63	3	3	63
	10	100	100	--	50	38	80	15	11	63	6	5	63	3	3	63
	13	100	100	--	50	38	80	10	8	80	6	5	80	3	3	63
	17	50	38	--	20	15	100	10	8	80	6	5	80	3	3	63
	22	40	30	125	15	11	100	8	6	100	6	5	80	3	3	63
	26	40	30	125	15	11	100	8	6	100	6	5	80	3	3	63
32	30	22	125	15	11	100	6	4	100	5	4	80	3	3	63	
M4-32R	0,16 ... 1,0	100	100	--	100	100	--	100	100	--	100	100	--	100	100	--
	1,6	100	100	--	100	100	--	100	100	--	100	100	--	100	100	--
	2,5	100	100	--	100	100	--	100	100	--	100	100	--	8	8	35
	4	100	100	--	100	100	--	100	100	--	100	100	--	8	8	40
	6	100	100	--	100	100	--	100	100	--	100	100	--	6	6	50
	8	100	100	--	100	100	--	50	38	80	50	38	63	6	6	63
	10	100	100	--	100	100	--	50	38	80	50	38	80	6	6	63
	13	100	100	--	100	100	--	50	38	80	42	32	80	6	6	63
	17	100	100	--	50	38	100	20	15	80	10	8	80	4	4	63
	22	100	100	--	50	38	125	20	15	100	10	8	80	4	4	63
	26	100	100	--	50	38	125	20	15	100	10	8	80	4	4	63
	32	100	100	--	50	38	125	20	15	100	10	8	80	4	4	63
M4-63R	26	100	100	--	50	50	125	35	27	125	12	9	100	5	5	80
	32	100	100	--	50	50	125	35	27	125	10	8	100	5	5	80
	40	100	100	--	50	50	160	35	27	125	10	8	100	5	5	80
	50	100	100	--	50	50	160	35	27	125	10	8	100	5	5	80
	63	100	100	--	50	50	160	35	27	160	10	8	100	5	5	80
M4-100R	63	100	100	--	50	38	160	40	30	160	12	9	100	6	5	80
	75	100	100	--	50	38	160	40	30	160	8	6	125	5	4	100
	90	100	100	--	50	38	160	40	30	160	8	6	125	5	4	125
	100	100	100	--	50	38	160	40	30	160	8	6	125	5	4	125



-- No back-up fuse required
 1) Back up fuse required if short-circuit current at installation point > I_{cu}
 2) 10 % overvoltage
 3) 5 % overvoltage

Technical Data according to IEC/EN 60947-1, 60947-2, 60947-4-1 and VDE 0660

Main Circuit

Type		M4-32T	M4-32R	M4-63R	M4-100R
Number of poles		3	3	3	3
Max. rated current I_{nmax} (=max. rated operational current I_n)	A	32	32	63	100
Permissible ambient temperature					
Storage/transport	°C	-50 to +80	-50 to +80	-50 to +80	-50 to +80
Operation	°C	-20 to +60	-20 to +60	-20 to +60	-20 to +60
Storage/transport	°F	-58 to +176	-58 to +176	-58 to +176	-58 to +176
Operation	°F	-4 to +140	-4 to +140	-4 to +140	-4 to +140
Rated insulation voltage U_i	V	690 ¹⁾	690 ¹⁾	1000 ²⁾	1000 ²⁾
Rated impulse withstand voltage U_{imp}	kV	6	6	8	8
Rated operational voltage U_e	V	690	690	690	690
Rated frequency	Hz	50/60	50/60	50/60	50/60
Utilization category					
IEC 60947-2 (circuit-breaker)		A	A	A	A
IEC 60947-4-1 (motor starter)		AC3	AC3	AC3	AC3
Class	acc. to IEC 60947-4-1	10	10	10	10
Power loss P_v per circuit-breaker dependent on rated current I_n (upper setting range)	I_n -> up to 4 A I_n -> 6 up to 26 A I_n -> 32 A	W W W	9,8 8 3,9	- - -	- - -
R per conducting path = $P/I^2 \times 3$	I_n -> 26 up to 63 A I_n -> up to 63 A I_n -> 75 up to 100 A	W W W	- - -	12,6 - -	- 11,9 15
Shock resistance	acc. to IEC 60068 Teil 2-27	g	25	25	25
Degree of protection	acc. to IEC 60529		IP 20	IP 20	IP 20
Shock hazard protection	acc. to DIN VDE 0106 Part 100		safe against finger touch	safe against finger touch	safe against finger touch
Temperature compensation	acc. to IEC 60947-4-1	°C	-20 to +60	-20 to +60	-20 to +60
Mechanical endurance	operating cycles		100 000	100 000	50 000
Electrical endurance			100 000	100 000	25 000
Max. operating frequency per hour (motor starts)	1/h		25	25	25





Approvals

Country Type	 USA UL	 Switzerland SEV	 Europe CCC	CB/CCA-Certificates
M4-32T	o	o	/	o
M4-32R	o	o	/	o
M4-63R	o	o	/	o
M4-100R	o	o	/	o
M4 H..	o	-	/	-
M4 M..	o	-	/	-
M4 U..	o	-	/	-
M4 A..	o	-	/	-

o In standard version approved / No testing required CE x In test
 - Not provided for test till now

1) Suitable at 690V for: earthed-neutral systems, overvoltage category I to IV, pollution degree 3 (standard-industry): $U_{imp} = 6kV$.
 2) Suitable at 1000V for: earthed-neutral systems, overvoltage category I to IV, pollution degree 3 (standard-industry): $U_{imp} = 8kV$.
 3) Data for other conditions on request.

Conductor cross-sections for main circuit

Type	Terminal type, screw type	Tightening torque		Conductor, cross-sections solid		Conductor, cross-sections stranded		Conductor, cross-sections flexible	
		Nm	lb - in	mm ²	AWG	mm ²	AWG	mm ²	AWG
M4-32T 	Pz2	0,8 - 2,5	7 - 22	1 x (1 - 10) 2 x (1 - 6)	1 x (18 - 8) 2 x (18 - 10)	1 x (1 - 6) 2 x (1 - 6)	1 x (18 - 10) 2 x (18 - 10)	1 x (1 - 6) 2 x (0,75 - 4)	1 x (18 - 10) 2 x (18 - 10)
M4-32R 	Pz2	0,8 - 2,5	7 - 22	1 x (1 - 10) 2 x (1 - 6)	1 x (18 - 8) 2 x (18 - 10)	1 x (1 - 6) 2 x (1 - 6)	1 x (18 - 10) 2 x (18 - 10)	1 x (1 - 6) 2 x (0,75 - 4)	1 x (18 - 10) 2 x (18 - 10)
M4-63R 	Pz2	3 - 4,5	26 - 39	1 x (0,75 - 35) 2 x (0,75 - 25)	1 x (18 - 2) 2 x (18 - 4)	1 x (0,75 - 35) 2 x (0,75 - 25)	1 x (18 - 2) 2 x (18 - 4)	1 x (0,75 - 25) 2 x (0,75 - 16)	1 x (18 - 4) 2 x (18 - 6)
M4-100R 	4mm hexagon socket screw	4 - 6	35 - 53	1 x (2,5 - 70) 2 x (2,5 - 50)	1 x (12 - 2/0) 2 x (12 - 1/0)	1 x (2,5 - 70) 2 x (2,5 - 50)	1 x (12 - 2/0) 2 x (12 - 1/0)	1 x (2,5 - 50) 2 x (2,5 - 35)	1 x (12 - 1/0) 2 x (10 - 2)

Auxiliary switches

Type	Rated operational voltage		Rated operational current		Rated operational current		Rated operational voltage		Rated operational current	
	Ue		Ie/AC-15		Ie/AC-12 Ith		Ue		Ie/DC-13	
	V		A		A		V		A	
Front transverse auxiliary switch	M4 HQ..	24 240	3 3	5 5	24 220	1 0,1	DC L/R 200 ms			
Lateral auxiliary switch and signalling switch	M4 HS..									
	M4 M..	24 240	6 4	10 10	24 220	2 0,25				

Type	Power consumption		Response voltage		Response voltage acc. to	
	during pick-up	uninterrupted duty	trip	pick-up	IEC 60947-1	
	VA/W		V		V	
Undervoltage release	M4 U..	8,5/6	3/1,2	0,7 - 0,35xUs	0,85 - 1,1xUs	
Shunt release	M4 A..	8,5/6	3/1,2			0,7 - 1,1xUs

Short-circuit protection for auxiliary and control circuits	Fuse	Miniature circuit breaker	solid	flexible	AWG-wires, solid	flexible
	gL/gG	C-characteristic	mm ²	mm ²	AWG	AWG
	16	6				
Conductor cross-sections for auxiliary and control circuits			1 x (0,5 - 2,5) 2 x (0,5 - 2,5) ¹⁾	1 x (0,5 - 4) 2 x (0,75 - 2,5)	1 x (20 - 14) 2 x (20 - 14) ¹⁾	1 x (20 - 10) 2 x (18 - 14)

1) M4 HQ.. 1 solid conductor only

Permissible ratings of devices approved for North America

Circuit breakers M4 as „Manual Motor Starter“

If used as „Manual Motor Starter“ the circuit breaker is always operated in combination with a short circuit device. For use with approbated fuses or circuit breakers according to UL489 or CSA22.2 No. 5 only. The sizes are selected according to National Electrical Code (UL), or Canadian Electrical Code (CSA).

Typ	Rated operational current le A	Max. short-circuit current			Motor load 1-phase		Motor load 3-phase				Max. rated fuse A	Max. breaker size A
		240V kA	480V kA	600V kA	115V HP	230V HP	200V HP	230V HP	460V HP	600V HP		
M4-32T	0,16 ... 0,63	100	50	10	-	-	-	-	-	-	1	15
	1	100	50	10	-	-	-	-	-	1/2	3	15
	1,6	100	50	10	-	1/10	-	-	3/4	3/4	6	15
	2,5	100	50	10	-	1/6	1/2	1/2	1	1 1/2	10	15
	4	100	50	5	1/8	1/3	3/4	3/4	2	3	15	15
	6	100	25	5	1/4	1/2	1	1 1/2	3	5	20	20
	8	100	25	5	1/3	1	2	2	5	5	30	30
	10	50	10	5	1/2	1 1/2	2	3	5	7 1/2	40	40
	13	50	10	5	1/2	2	3	3	7 1/2	10	50	50
	17	40	10	5	1	3	3	5	10	15	60	60
	22	30	10	5	1 1/2	3	5	7 1/2	15	20	80	80
	26	30	7,5	5	2	3	7 1/2	7 1/2	15	20	100	100
	32	20	7,5	5	2	5	7 1/2	10	20	30	125	125
M4-32R	0,16 ... 0,63	100	50	10	-	-	-	-	-	-	1	15
	4	100	50	10	1/8	1/3	3/4	3/4	2	3	15	15
	6	100	50	10	1/4	1/2	1	1 1/2	3	5	20	20
	8	100	50	10	1/3	1	2	2	5	5	30	30
	10	100	50	10	1/2	1 1/2	2	3	5	7 1/2	40	40
	13	100	50	10	1/2	2	3	3	7 1/2	10	50	50
	17	100	30	10	1	3	3	5	10	15	60	60
	22	100	30	10	1 1/2	3	5	7 1/2	15	20	80	80
	26	100	30	10	2	3	7 1/2	7 1/2	15	20	100	100
	32	100	30	10	2	5	7 1/2	10	20	30	125	125
M4-63R	26	100	50	10	2	3	7 1/2	7 1/2	15	20	100	100
	32	100	50	10	2	5	7 1/2	10	20	30	125	125
	40	100	50	10	3	7 1/2	10	10	30	30	150	150
	50	100	50	10	5	10	15	15	30	40	200	200
	63	100	50	10	5	10	20	20	40	60	250	250
M4-100R	63	100	25	10	5	10	20	20	40	60	250	250
	75	100	25	10	5	15	20	25	50	60	300	300
	90	100	25	10	7 1/2	20	25	30	60	75	350	350
	100	100	25	10	10	20	30	30	75	100	400	400

Permissible ratings of devices approved for North America

Circuit breakers M4 as „Combination Motor Controller Type E“ and "Suitable for Group Installation"

Acc to UL 489 demands a line-side 1 inch air and 2 inch creepage distance for „Combination Motor Controller Type E“ is necessary. Therefore circuit-breaker M4-32R is approved to UL 489 in combination with the Terminal block M4 32R E. Circuit-breakers M4-100 are approved to UL 489 in combination with the insulation barriers M4 100 E. According to CSA these terminal blocks can be omitted when the device is used as „Combination Motor Controller Type E“.

Type	Rated operational current I _e A	Max. short-circuit current			Motor load 1-phase		Motor load 3-phase				Max. rated fuse A	Max. breaker A
		240V kA	480V kA	600V kA	115V HP	230V HP	200V HP	230V HP	460V HP	600V HP		
M4-32R	0,16 ... 0,63	100	65	25	-	-	-	-	-	-	500	500
(+M4 32R E)	1	100	65	25	-	-	-	-	-	1/2	500	500
	1,6	100	65	25	-	1/10	-	-	3/4	3/4	500	500
	2,5	100	65	25	-	1/6	1/2	1/2	1	1 1/2	500	500
	4	100	65	25	1/8	1/3	3/4	3/4	2	3	500	500
	6	100	65	25	1/4	1/2	1	1 1/2	3	5	500	500
	8	100	65	25	1/3	1	2	2	5	5	500	500
	10	100	65	25	1/2	1 1/2	2	3	5	7 1/2	500	500
	13	100	65	25	1/2	2	3	3	7 1/2	10	500	500
	17	100	30	10	1	3	3	5	10	15	500	500
	22	100	30	10	1 1/2	3	5	7 1/2	15	20	500	500
	26	100	30	10	2	5	7 1/2	7 1/2	15	20	500	500
	32	100	30	10	2	5	7 1/2	10	20	30	500	500
M4-63R	26	100	50	10	2	3	7 1/2	7 1/2	15	20	600	600
	32	100	50	10	2	5	7 1/2	10	20	30	600	600
	40	100	50	10	3	7 1/2	10	10	30	30	600	600
	50	100	50	10	5	10	15	15	30	40	600	600
	63	100	50	10	5	10	20	20	40	60	600	600
M4-100R	63	100	40	10	5	10	20	20	40	60	1000	1000
(+M4 100 E)	75	100	40	10	5	15	20	25	50	60	1000	1000
	90	100	40	10	7 1/2	20	25	30	60	75	1000	1000
	100	100	40	10	10	20	30	30	75	100	1000	1000

Ratings of auxiliary switches and alarm switches

	Breaking capacity		Rated operational voltage max. V AC	Rated operational current A
	AC	DC		
Lateral auxiliary M4 HS.. and signalling switch M4 M..	A600	Q300	600	10
Transversal auxiliary switch M4 HQ..	A300	R300	240	5

Description

Releases

Circuit-breakers M4 are equipped with bimetallic-based, inverse-time delayed overload releases and with instantaneous overcurrent releases (electromagnetic short-circuit releases). The overload releases can be set in accordance with the load current. The overcurrent releases are permanently set to a value 13 times the rated current and thus enable trouble-free start-up of motors. The scale cover can be sealed to prevent unauthorized adjustments to the set current.

Operating mechanisms

Circuit-breakers M4-32T are actuated via a rocker operating mechanism and circuit-breakers M4-32R, M4-63R and M4-100R via a rotary operating mechanism. An electrical signal can be output, at all Circuit-breakers, via a signalling switch to indicate that the Circuit-breaker has tripped. All operating mechanisms can be locked in the 0 position with a padlock (shackle diameter 3.5 to 4.5 mm). The M4 Circuit-breakers fulfil the isolation characteristics specified in IEC 60947-2.

Operating conditions

Circuit-breakers M4 are suitable for use in any climate. To avoid error tripping we recommend to protect the Circuit Breakers M4 against fresh and cold air (caused by air condition etc.) They are designed for operation in enclosed rooms under normal conditions (e. g. no dust, corrosive vapours or harmful gases). Suitable enclosures must be provided for installation in dusty or damp rooms. Circuit-breakers M4 can also be fed from below. In order to prevent premature tripping due to phase failure sensitivity, the three conducting paths must always be uniformly loaded. The conducting paths must be connected in series in the case of single-phase loads.

Short-circuit protection

The short-circuit releases of M4 circuit-breakers disconnect the faulty load feeder from the system in the event of a short circuit and thus prevent any further damage from being caused. Circuit-breakers with a short-circuit breaking capacity of 50 kA or 100 kA at a voltage of 400 V AC are practically short-circuit-proof at this voltage, as higher short-circuit currents are not usually encountered at the installation point. Back-up fuses are only necessary if the short-circuit current at the installation point exceeds the rated ultimate short-circuit breaking capacity of the circuit-breakers.

Motor protection

The tripping characteristics of M4 circuit-breakers are designed mainly to protect three-phase induction motors. The circuit-breakers are therefore also referred to as Manual Motor Starters. The current of the motor to be protected is set with the aid of the scale.

Line protection

M4 Circuit-breakers for motor protection are also suitable for line protection. The M4 Circuit-breakers fulfil the isolation conditions of IEC 60 947-3 as well as the additional test conditions for circuit-breakers with isolation characteristics specified in IEC 60947-2. Taking IEC 60 204-1 into consideration, they can thus be implemented as main and EMERGENCY STOP switches. Door-coupling rotary operating mechanism do not fulfil the isolation characteristics.

Tripping-Characteristics

M4-32

M4-63R, M4-100R

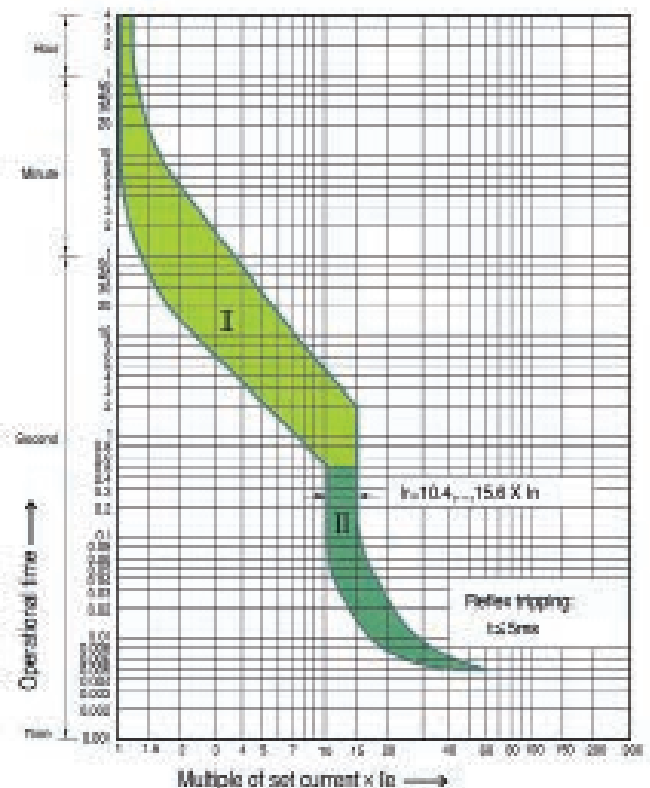
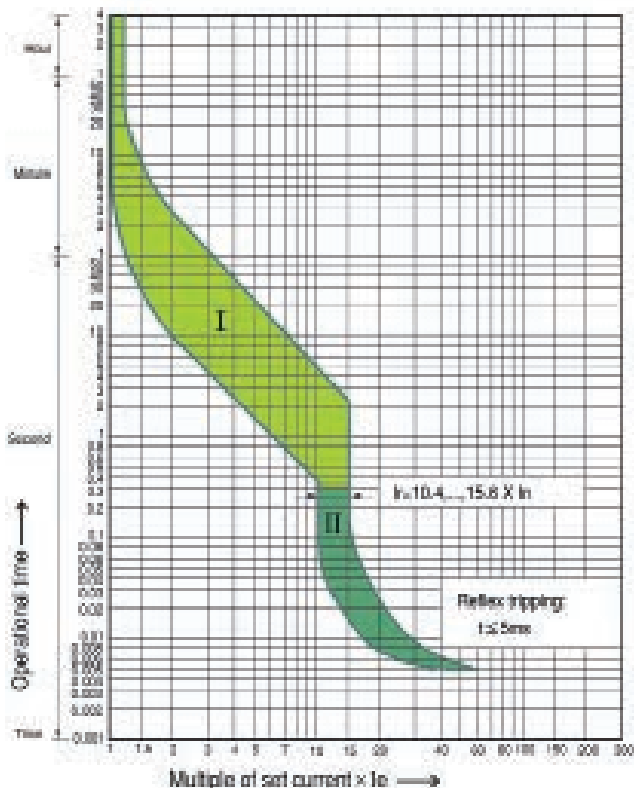

I The curve shows the mean operating current at an ambient temperature of 20°C starting from cold.

II The tripping characteristic of electromagnetic overcurrent releases (short-circuit releases)

The tripping characteristic of the inverse-time delayed overload releases apply for DC and AC with a frequency of 0 to 400 Hz. At operating temperature, the tripping times of the thermal releases are reduced to approximately 25 %.

The characteristic shown here is a schematic representation of circuit-breakers for all ranges. Current limiting characteristics and I^2t characteristics are available on request.

Let-through Energy (I^2t / kA^2s) and Peak Current (I_p / kA) at $U_e=415\text{V}$

M4-32R

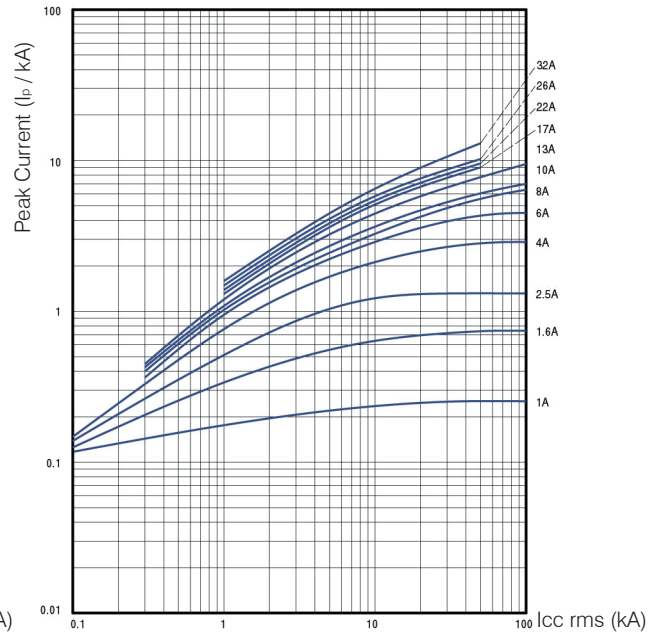
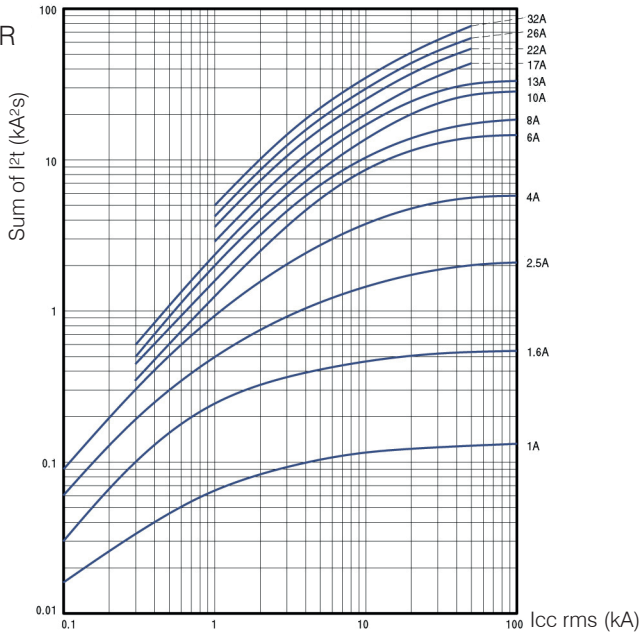

M4-63R

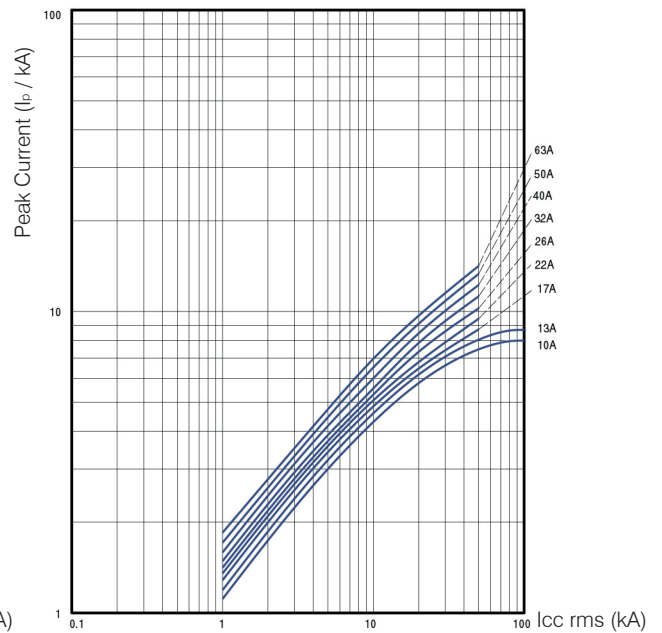
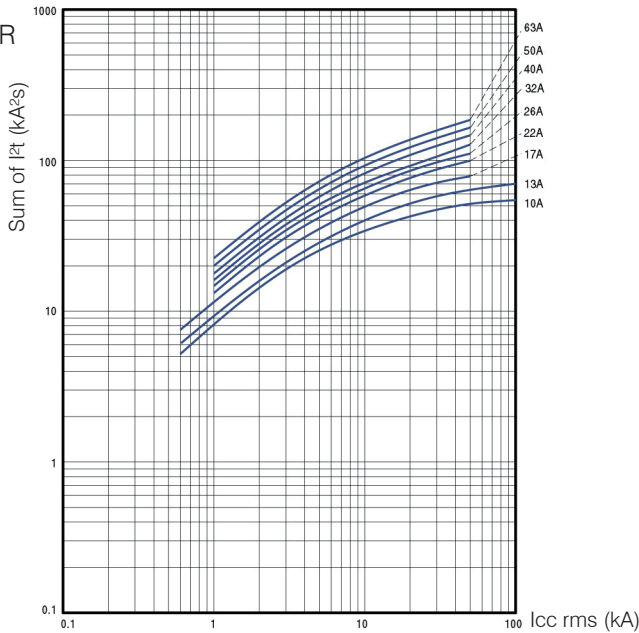

M4-100R

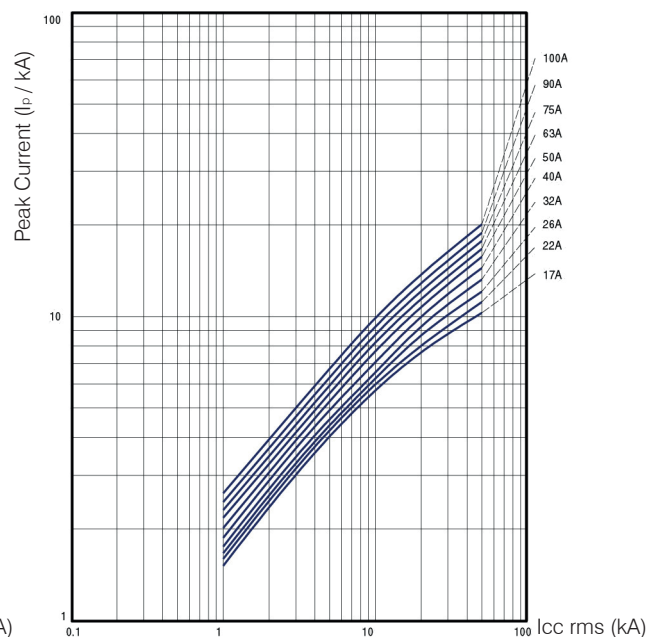
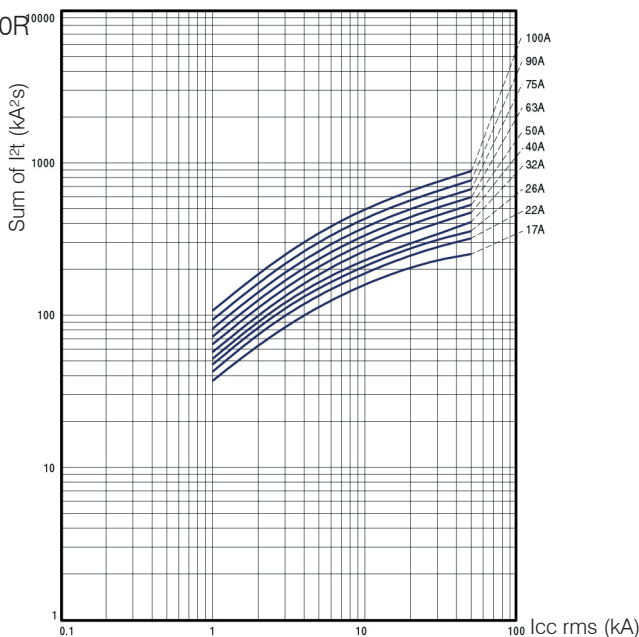

Mounting

DIN-rail mounting

Operating positions

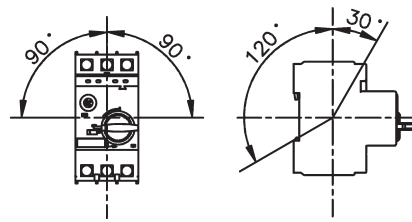
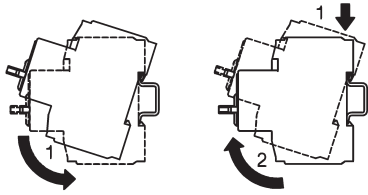

Current setting (dont rotate the dial out of the shown range)

Connection of 1-phase motor

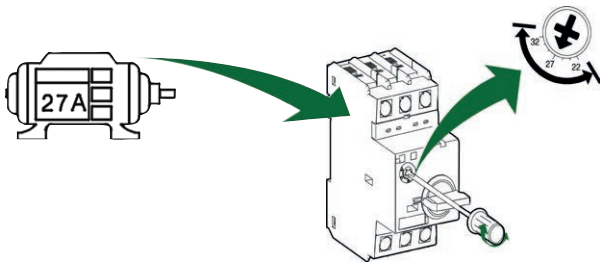

Wiring diagrams

Circuit breaker

M4...

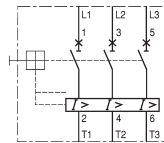

Traverse Aux. Contact Block

M4 HQ11

M4 HQ20

M4HQ02

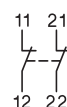

Aux. Contact Block (side mounted)

M4 HS11

M4 HS20

M4 HS02

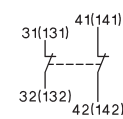
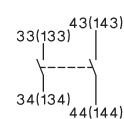
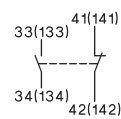

Alarm Switch

M4 M11

M4 MA11

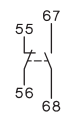

Undervoltage Release

M4 U...

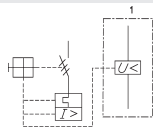

Shunt Release

M4 A...

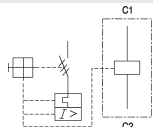

Installation of accessories

M4-32T
M4-32R

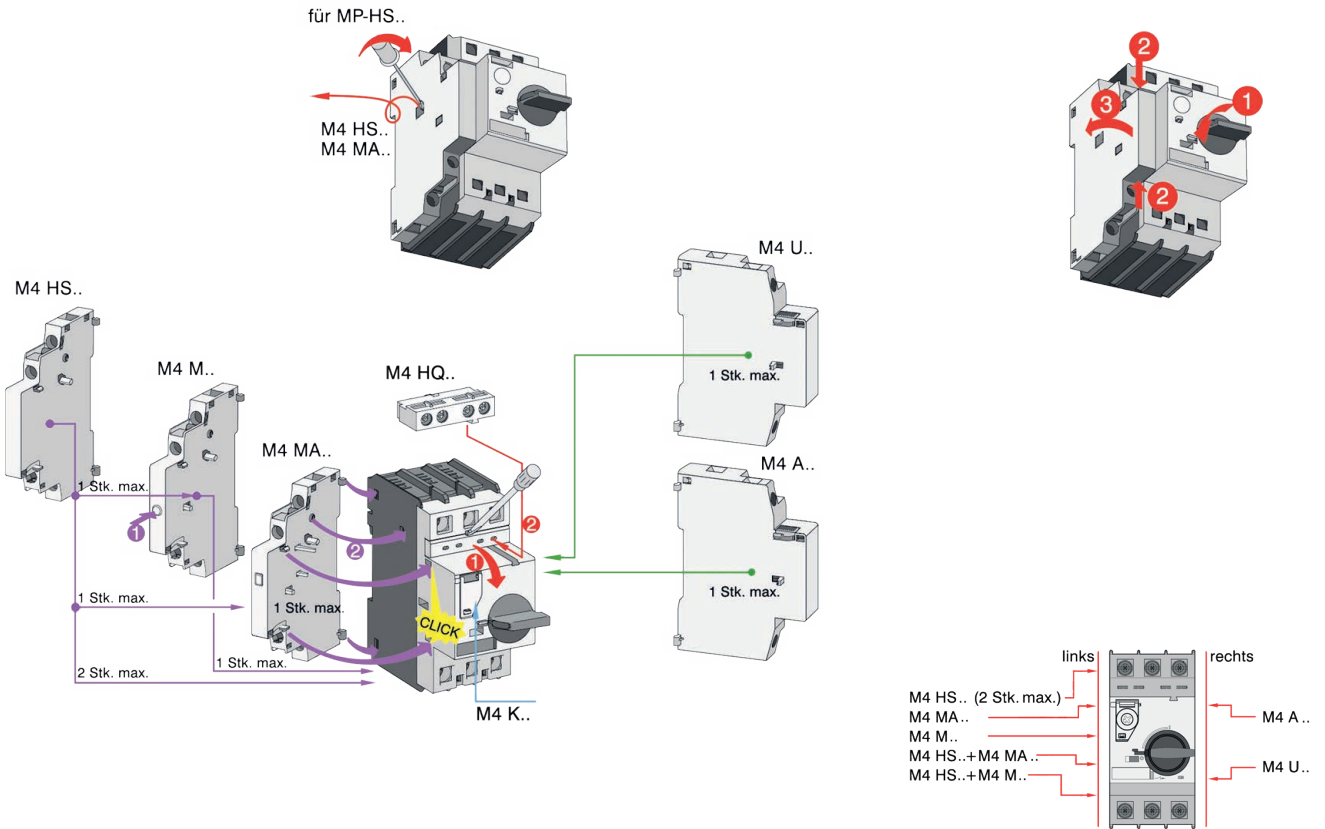

M4-63R
M4-100R

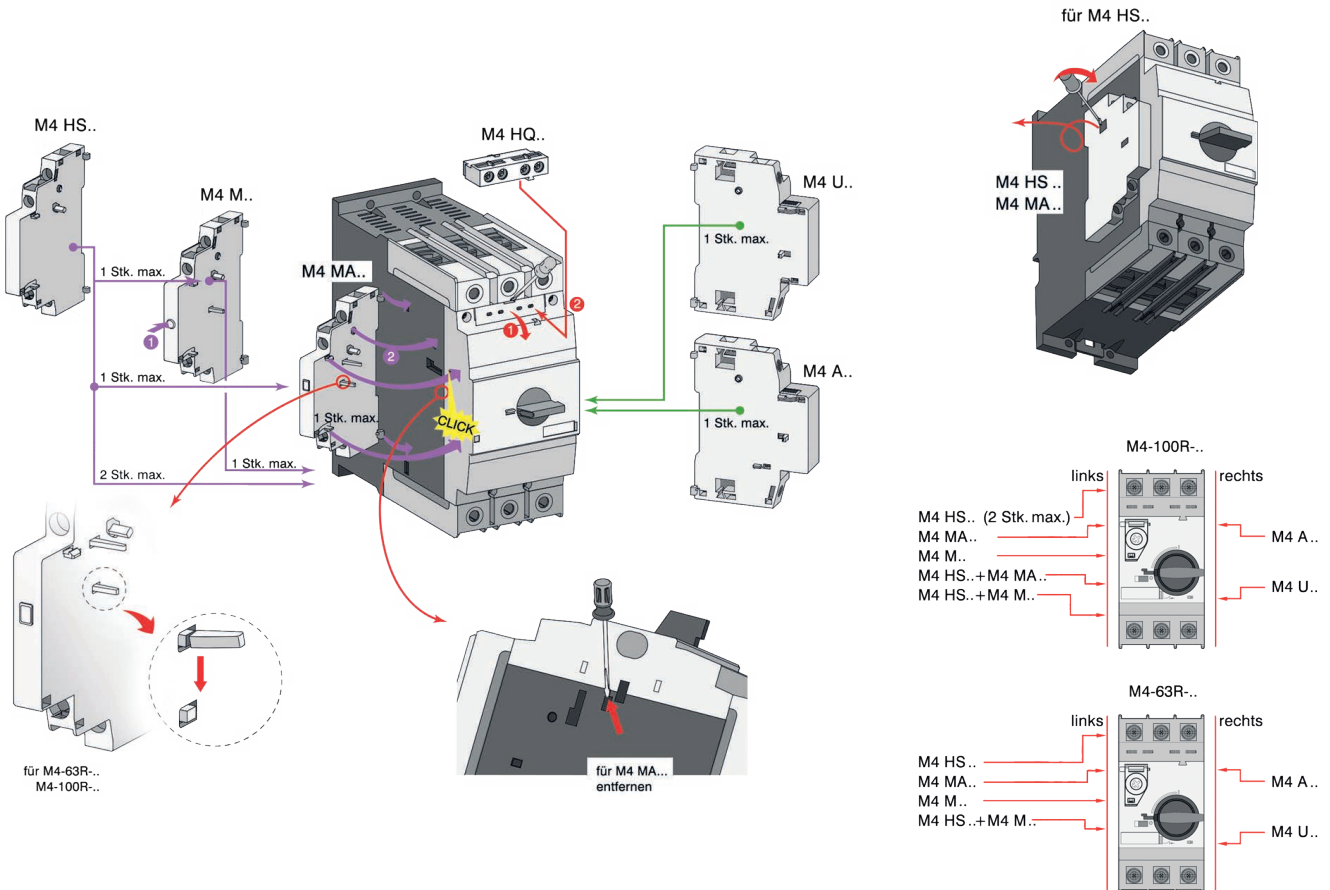

Dimensions

Circuit-breaker M4-32T

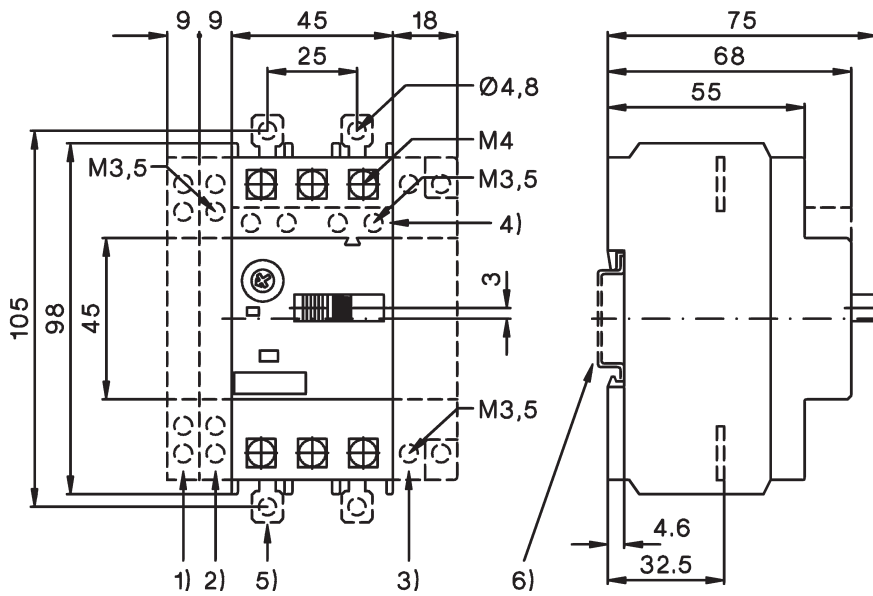

Height of arcing spaces (clearance from earthed parts)

at U _e (V)	240	415	460	525	690
mm	20	20	20	20	20
inch	0,8	0,8	0,8	0,8	0,8

- 1) Side aux. contact
- 2) Magnetic trip alarm
- 3) Shunt or undervoltage release of arcing
- 4) Transverse aux. contact
- 5) Push-in Lugs for screw mounting
- 6) 35mm DIN-rail acc. to EN 50022

Circuit-breaker M4-32R

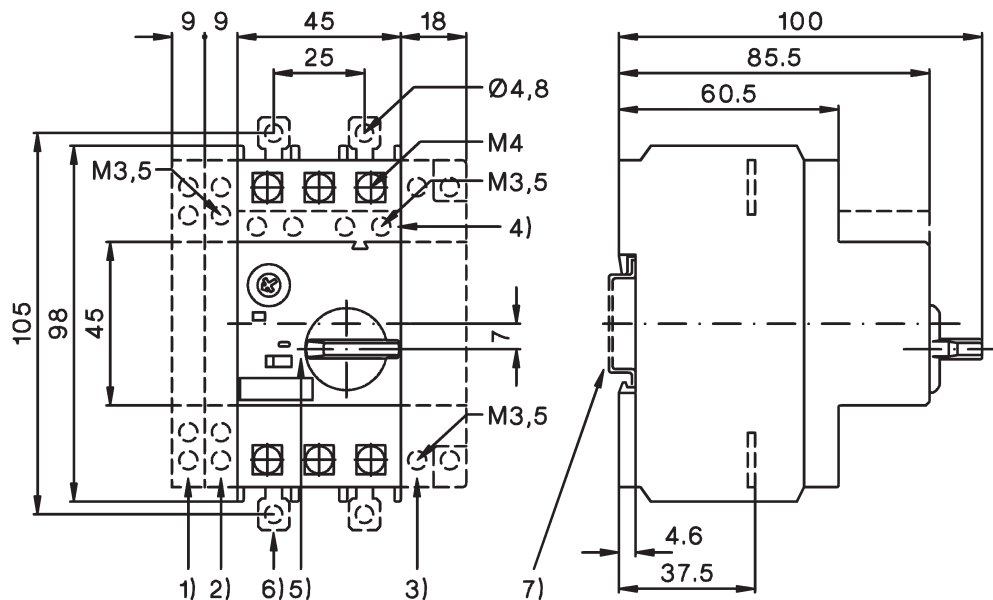

Height of arcing spaces (clearance from earthed parts)

at U _e (V)	240	415	460	525	690
mm	30	30	30	30	50
inch	1,18	1,18	1,18	1,18	2

- 1) Side aux. contact
- 2) Magnetic trip alarm
- 3) Shunt or undervoltage release of arcing
- 4) Transverse aux. contact
- 5) Handle lock in OFF-position (Ø 5mm)
- 6) Push-in Lugs for screw mounting
- 7) 35mm DIN-rail acc. to EN 50022

Dimensions

Circuit-breaker M4-63R

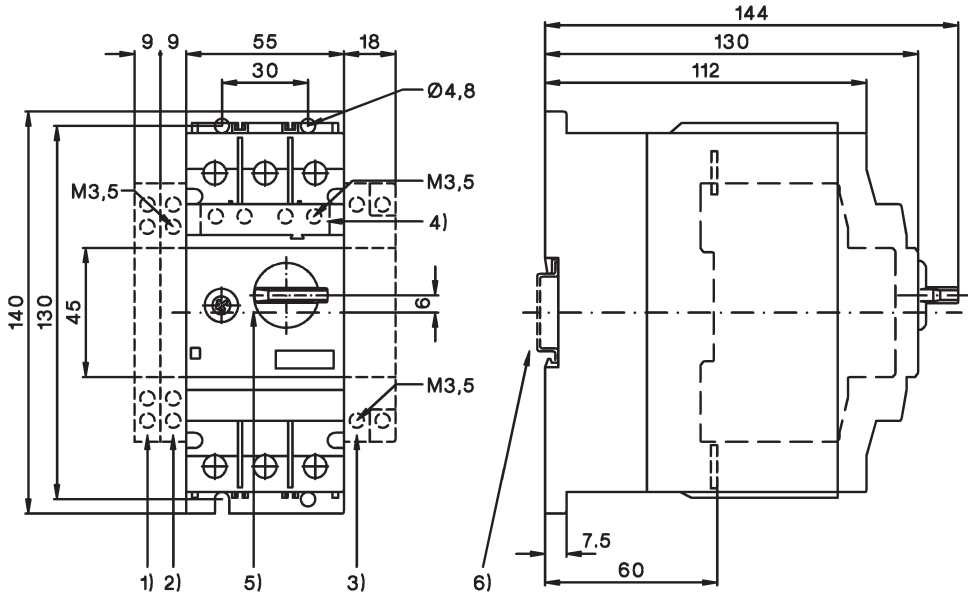

- 1) Side aux. contact
- 2) Magnetic trip alarm
- 3) Shunt or undervoltage release
- 4) Transverse aux. contact
- 5) Handle lock in OFF-position (Ø 5mm)
- 6) 35mm DIN-rail acc. to EN 50022

Height of arcing spaces (clearance from earthed parts)

at Ue (V)	240	415	460	525	690
mm	50	50	50	50	50
inch	2	2	2	2	2

Circuit-breaker M4-100R

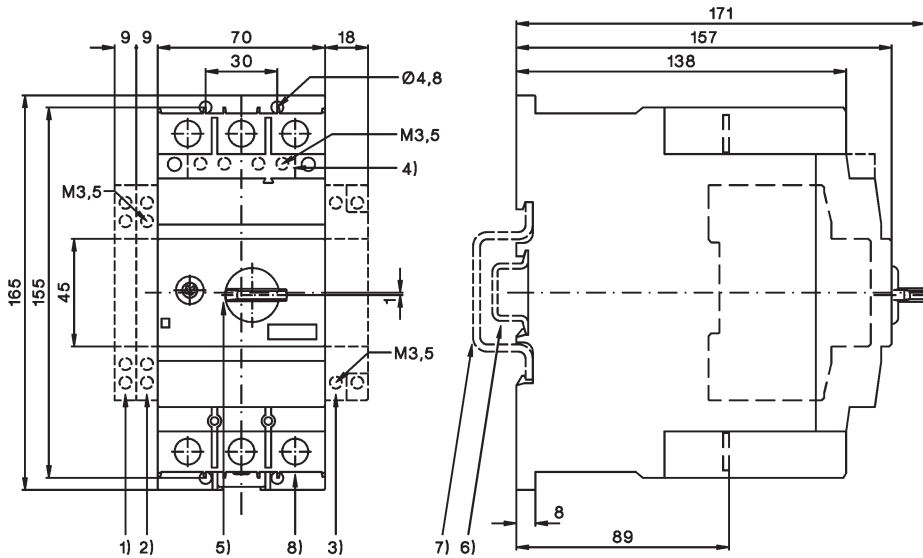

- 1) Side aux. contact
- 2) Magnetic trip alarm
- 3) Shunt or undervoltage release
- 4) Transverse aux. contact
- 5) Handle lock in OFF-position (Ø 5mm)
- 6) 35mm DIN-rail acc. to EN 50022
- 7) 70mm DIN-rail acc. to EN 50023
- 8) 4mm hexagon socket screw

Height of arcing spaces (clearance from earthed parts)

at Ue (V)	240	415	460	525	690
mm	50	70	70	110	150
inch	2	2¾	2¾	4.33	6

Dimensions

Link Module M4 32 VK1

M4-32T + K1- . .

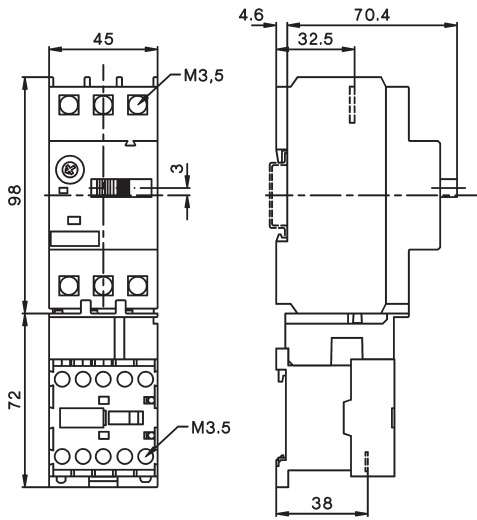

M4-32R + K1- . .

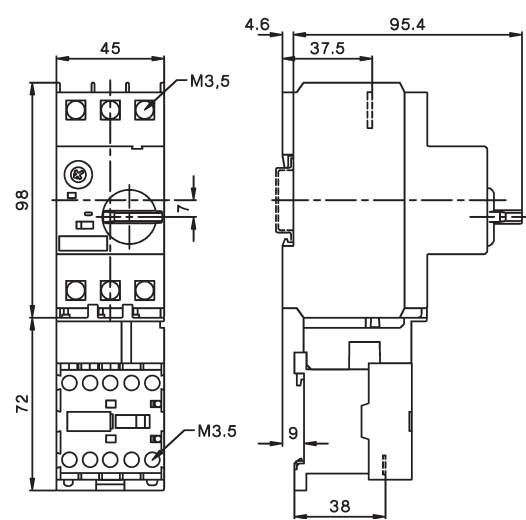

Link Module M4 32 VK3

M4-32T + K3-10ND. .
M4-32T + K3-18ND. .

M4-32T + K3-14ND. .
M4-32T + K3-22ND. .

M4-32R + K3-10ND. .
M4-32R + K3-18ND. .

M4-32R + K3-14ND. .
M4-32R + K3-22ND. .

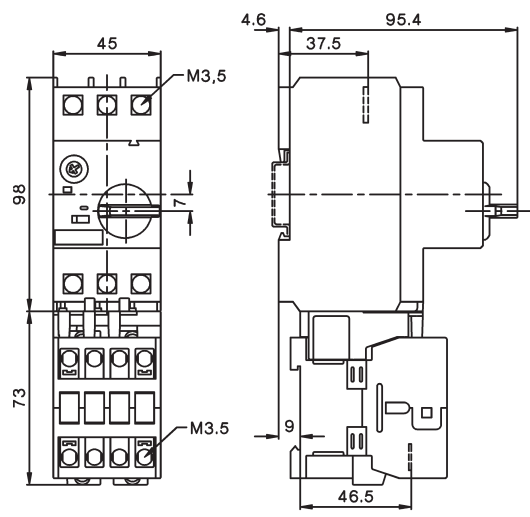
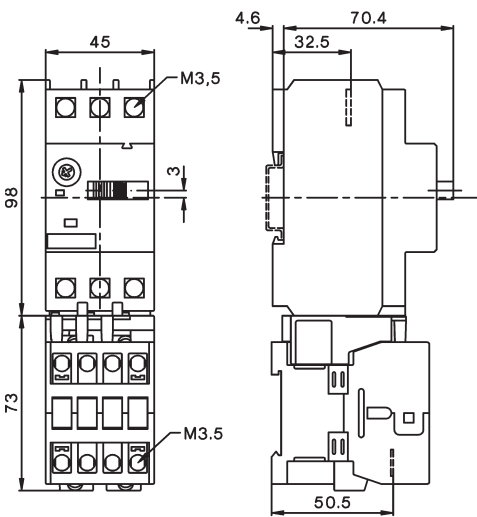

Link Module M4 32 VKG3

M4-32T + KG3-10. .
M4-32T + KG3-18. .

M4-32T + KG3-14. .
M4-32T + KG3-22. .

M4-32R + KG3-10. .
M4-32R + KG3-18. .

M4-32R + KG3-14. .
M4-32R + KG3-22. .

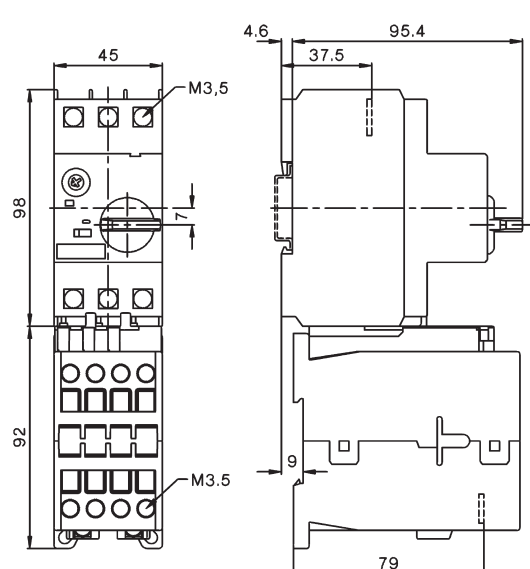
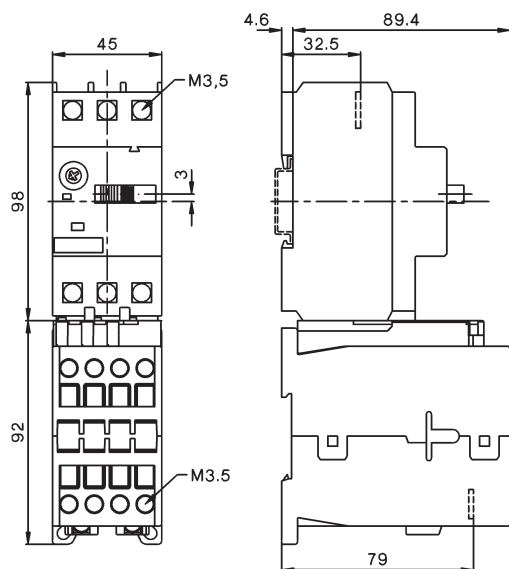

Dimensions

DIN-rail adapter M4 32 HU1

M4-32T + K3-24 + M4 32VD
 M4-32T + K3-32 + M4 32VD

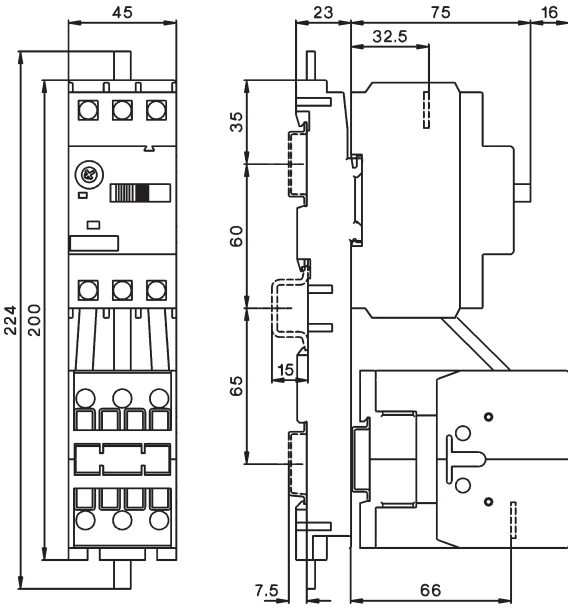

M4-32R + K3-24 + M4 32VD
 M4-32R + K3-32 + M4 32VD

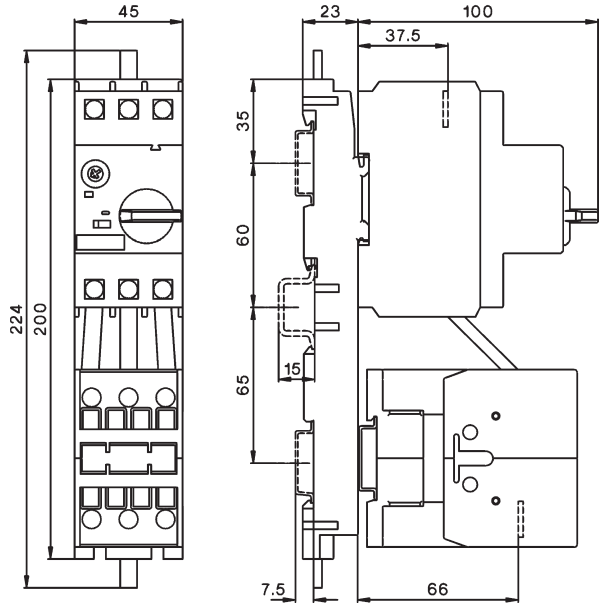

DIN-rail adapter M4 32 HU1

M4-32T + KG3-24 + M4 32 VD
 M4-32T + KG3-32 + M4 32 VD

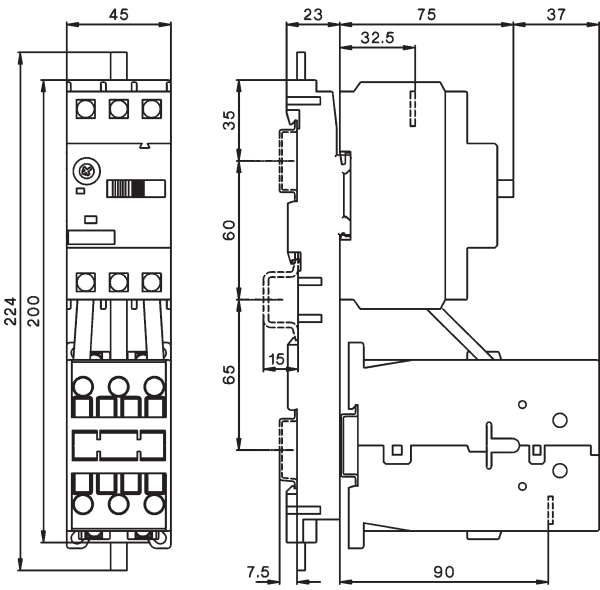

M4-32R + KG3-24 + M4 32 VD
 M4-32R + KG3-32 + M4 32 VD

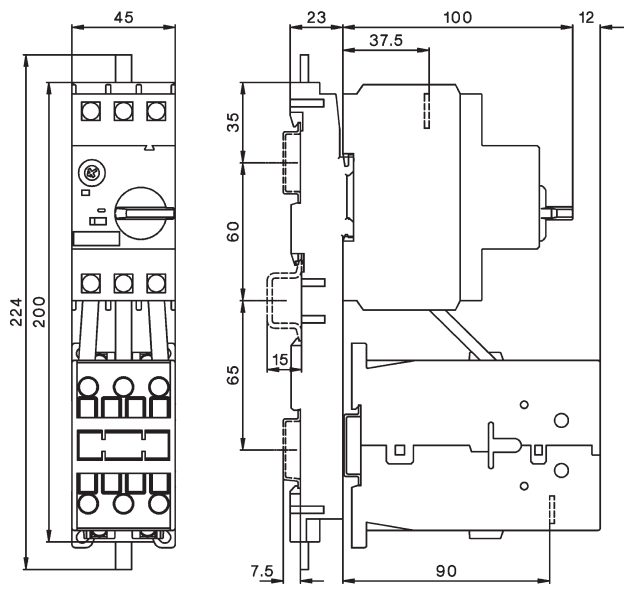

Dimensions

DIN-rail adapter M4 63 HU1

M4-63T + K3-32 + M4 63 VD
 M4-63T + K3-40 + M4 63 VD

M4-63T + KG3-32 + M4 63 VDG
 M4-63T + KG3-40 + M4 63 VDG

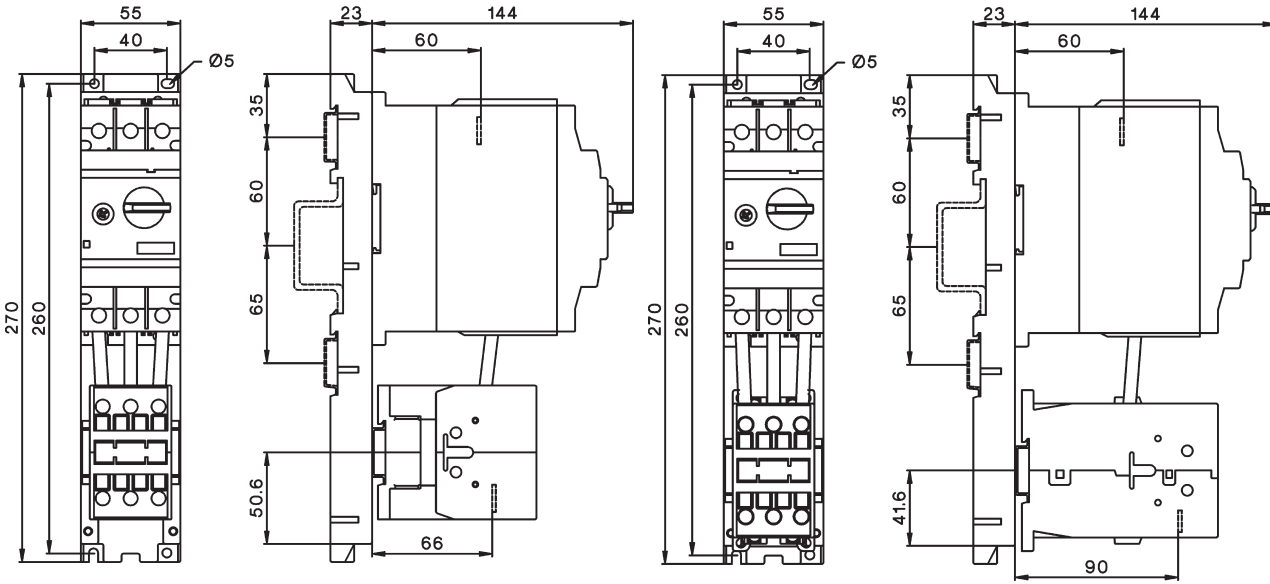

DIN-rail adapter M4 63 HU1

M4-63T + K3-50 + M4 63 VD
 M4-63T + K3-62 + M4 63 VD

DIN-rail adapter M4 100 HU1

M4-100R + K3-62 + M4 100 VD
 M4-100R + K3-74 + M4 100 VD

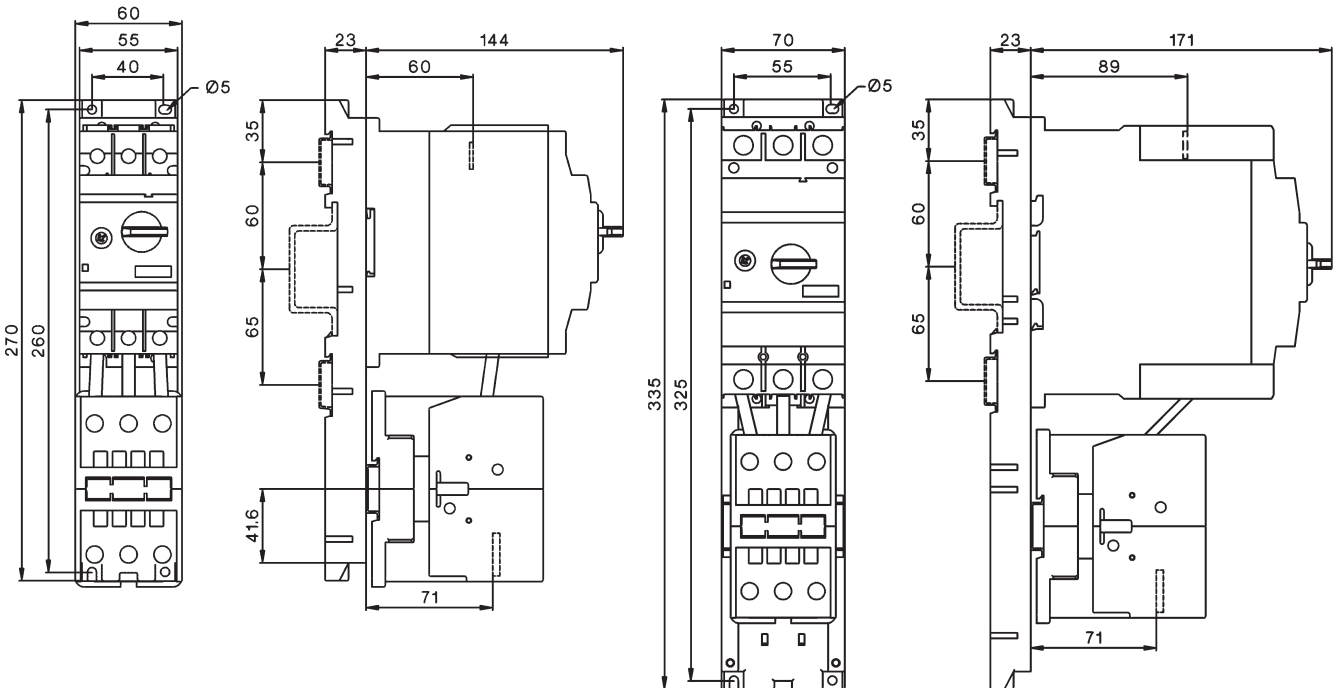

Dimensions

Enclosures

M4 32R PFH4
M4 32R PFHN4

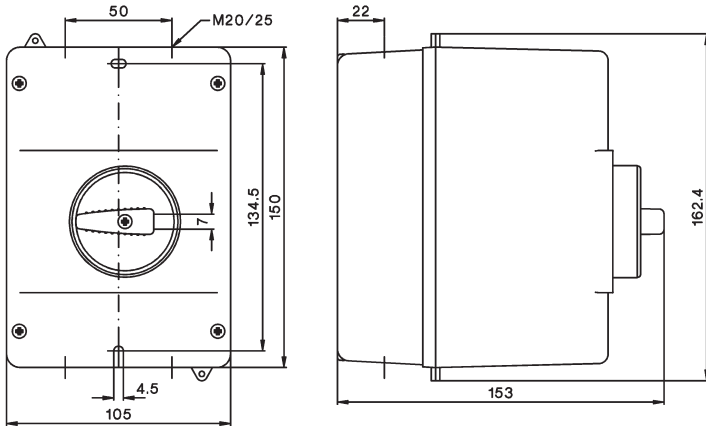

Door-coupling rotary mechanisms

Mounting holes

Type	A
M4 32R EH1 115	149 - 210
M4 32R EHN1 115	149 - 210
M4 32R EH1 315	149 - 410
M4 32R EHN1 315	149 - 410

Type	A
M4 63R EH1 115	194 - 255
M4 63R EHN1 115	194 - 255
M4 63R EH1 315	194 - 455
M4 63R EHN1 315	194 - 455

Type	A
M4 100R EH1 115	220 - 282
M4 100R EHN1 115	220 - 282
M4 100R EH1 315	220 - 482
M4 100R EHN1 315	220 - 482

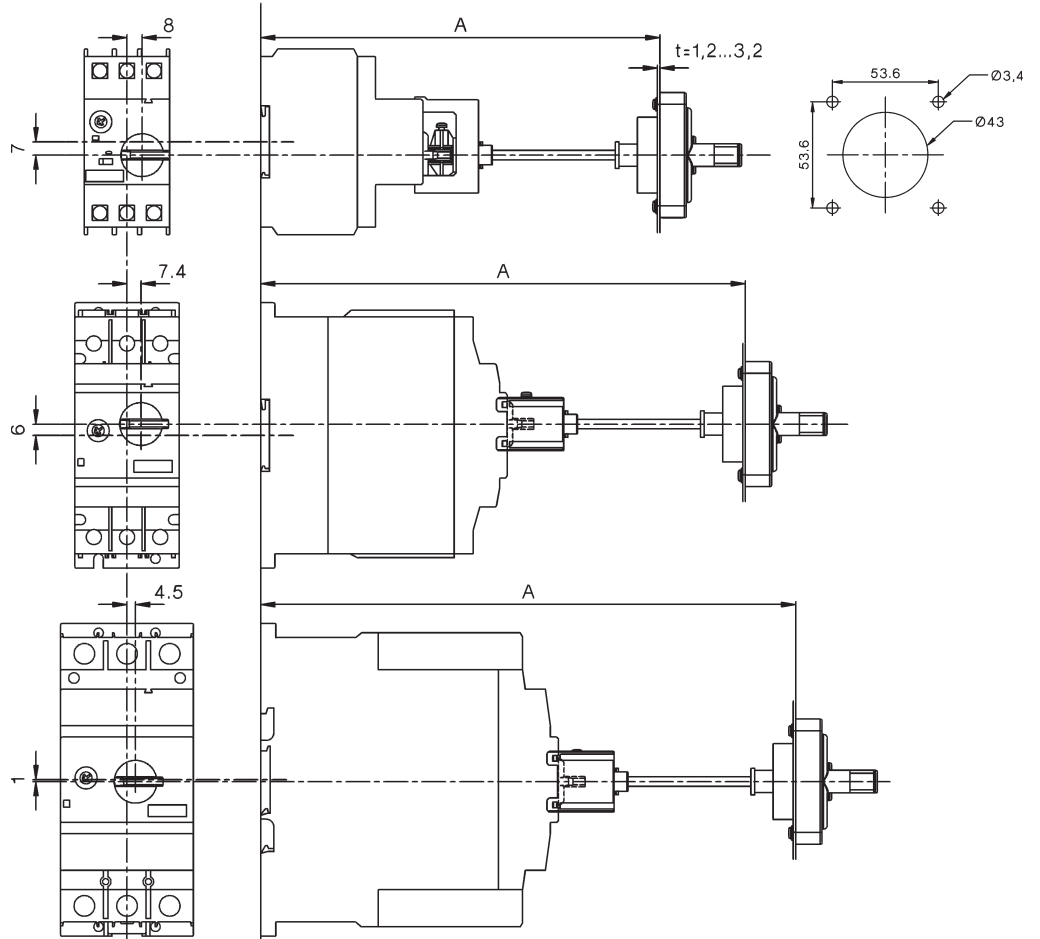

Insulated 3-phase busbar system

M4 32 S..

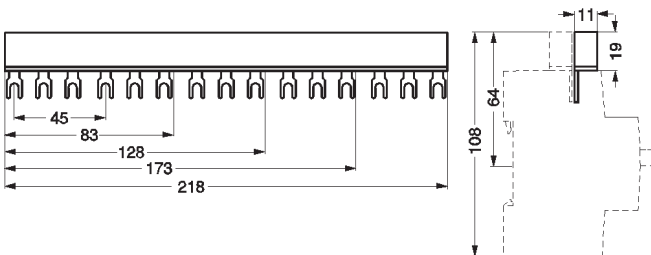

M4 32 SE

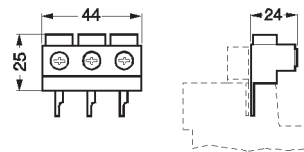

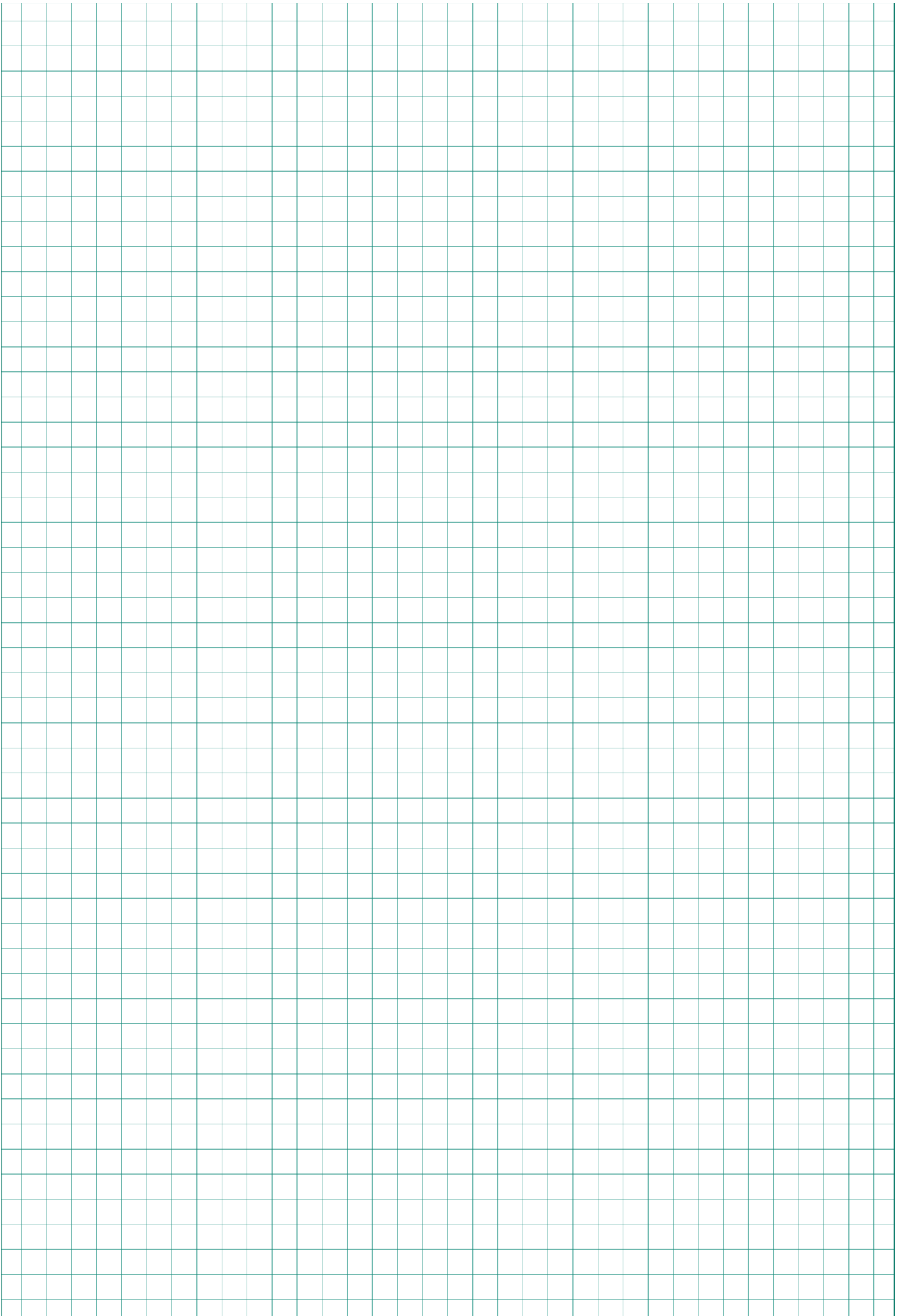



Manual Motors Starters

188



Auxilliary Contact Blocks

188



Trip Alarm Aux. Switch

188



Shunt Release

188



Under-voltage Release

189



Accessories

189



Busbar Connectors

189



Enclosures

189



Technical Data

190

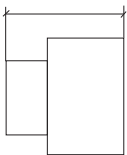

Dimensions

191



Tripping Characteristic

191

Manual Motor Starters



Thermal Overload Release Setting Range A	Ratings AC3 at 400V kW	690V kW	Magnetic short circuit trip A	Type	Pack pcs.	Weight kg/pc.
0,1 - 0,16	0,02	0,06	1,92	MU25A-0,16 MU25A-0,25 MU25A-0,4	1	0,25
0,16 - 0,25	0,06	0,12	3,0		1	0,25
0,25 - 0,4	0,09	0,18	4,8		1	0,25
0,4 - 0,63	0,12	0,25	7,6	MU25A-0,63 MU25A-1 MU25A-1,6	1	0,25
0,63 - 1	0,25	0,55	12,0		1	0,25
1 - 1,6	0,55	1,1	19,2		1	0,25
1,6 - 2,5	0,75	1,5	30	MU25A-2,5 MU25A-4 MU25A-6,3	1	0,25
2,5 - 4	1,5	3	48		1	0,25
4 - 6,3	2,5	4	75,6		1	0,25
6,3 - 10	4	7,5	120	MU25A-10 MU25A-16 MU25A-20	1	0,25
10 - 16	7,5	11	192		1	0,25
16 - 20	9	12	240		1	0,25
20 - 25	12,5	22	300	MU25A-25 MU25A-32	1	0,25
25 - 32	15		384		1	0,25

Auxiliary Contact Blocks, for side mounting, max. 2 pieces



Contacts			Rated Operational Current			Type	Pack pcs.	Weight kg/pc.
NO	NC	EM ¹⁾	AC15 230V A	400V A	AC1 500V A			
1	-	-	3,5	2	6	MU25A-PS10 MU25A-PS01 MU25A-PS20 MU25A-PS11	10	0,03
-	1	-	3,5	2	6		10	0,03
2	-	-	3,5	2	6		10	0,03
1	1	-	3,5	2	6		10	0,03
-	2	-	3,5	2	6	MU25A-PS02 MU25A-PV11 MU25A-PV20	10	0,03
-	1	-	3,5	2	6		10	0,03
-	-	2	3,5	2	6		10	0,03

Transverse Auxiliary Contact Block, max. 1 piece



Contacts			Rated Operational Current			Type	Pack pcs.	Weight kg/pc.
NO	NC	EM ¹⁾	AC15 230V A	400V A	AC1 230V A			
1	1	-	1		5	MU25A-PA11	10	0,02

Auxiliary Contact Blocks for mounting under the cover, max. 1 piece



Contacts			Rated Operational Current			Type	Pack pcs.	Weight kg/pc.
NO	NC	EM ¹⁾	AC15 230V A	400V A	AC1 500V A			
1	1	-	3,5	2	6	MU25A-PE11	10	0,02

Trip Alarm Auxiliary Switch for mounting under the cover, max. 1 piece



Contacts			Rated Operational Current			Type	Pack pcs.	Weight kg/pc.
NO	NC	EM ¹⁾	AC15 230V A	400V A	AC1 500V A			
1	-	-	3,5	2	6	MU25A-PM10 MU25A-PM01	10	0,02
-	1	-	3,5	2	6		10	0,02

1) early make

Shunt Release for mounting under the cover



Rated Control Voltage and Frequency V	Power Consumption		Type	Pack pcs.	Weight kg/pc.
	VA	W			
24V 50/60Hz	2,7	1,8	MU25A-A24	10	0,06
110V 50Hz, 110-120V 60Hz	2,7	1,8	MU25A-A110	10	0,06
220-230V 50Hz, 240V 60Hz	2,7	1,8	MU25A-A230	10	0,06
380-415V 50Hz, 440V 60Hz	2,7	1,8	MU25A-A400	10	0,06

Under-voltage Release for mounting under the cover



Rated Control Voltage and Frequency V	Power Consumption		Type	Pack pcs.	Weight kg/pc.
	VA	W			
24V 50/60Hz	2,7	1,8	MU25A-U24	10	0,06
110V 50Hz, 110-120V 60Hz	2,7	1,8	MU25A-U110	10	0,06
220-230V 50Hz, 240V 60Hz	2,7	1,8	MU25A-U230	10	0,06
380-415V 50Hz, 440V 60Hz	2,7	1,8	MU25A-U400	10	0,06

Accessories



Description	Specification	Type	Pack pcs.	Weight kg/pc.
Busbar Connector Fully Isolated, U_i 690V, I_u 63A				
Busbar	For 2 units 3-pole, 99mm long	MU25A-D99	10	0,036
Busbar	For 3 units 3-pole, 154mm long	MU25A-D154	10	0,060
Busbar	For 4 units 3-pole, 208mm long	MU25A-D208	10	0,084
Busbar	For 5 units 3-pole, 262mm long	MU25A-D262	10	0,107
Supply Block	3-pole for use with busbar connector	MU25A-DB	10	0,034
Spacing piece 1/2TE	for ambient temperature >40°C	P730	10	0,013



Enclosures				
Moulded Enclosure	Protection to IP55	MU25A-O55	1	0,24
Moulded Front Plate	Protection to IP55	MU25A-C55	1	0,16
Locking Bracket	Suitable for 3 padlocks in "OFF"-position, stirrup diameter of the padlock max. 8 mm	MU25A-Z	1	0,10
Stop Button	Mushroom head	MU25A-NAT	1	0,04
Emergency Stop Button	latch, release by turning	MU25A-NAV	1	0,04
Emergency Stop Button	latch, release by key	MU25A-NAS	1	0,04
Neutral Conductor Block	for mounting in enclosure and front plate Wiring cross section 0,75 - 2,5mm ²	MU25A-NL	10	0,01
Moulded Enclosure for 5-pole CEE-plug	Protection to IP54 with phase changing	MU25A-GC1	1	0,40

Manual Motor Starters

Data according to IEC 947, IEC 204, EN 60947, EN 60204, VDE 0660, VDE 0113

Type	MU25A				
Main Contacts					
Rated insulation voltage U_i	V~ ¹⁾	690			
Rated operational current I_e ($=I_{th}$) open, at 50°C	A	25			
Mechanical life	S x 10 ⁶	0,1			
Contact life at I_e /AC3	S x 10 ⁶	0,1			
Tripping class according to IEC 60947-4-1		10A			
Rated ultimate short-circuit breaking capacity I_{cu} Values for open unit, when incoming supply on upper terminals		220-240V AC	380-415V AC	500V AC	660-690V AC
Setting range					
to 1A	kA	100	100	100	100
1 - 1,6A	kA	100	100	100	100
1,6 - 2,5A	kA	100	100	3	2,5
2,5 - 4A	kA	100	100	3	2,5
4 - 6,3A	kA	100	100	3	2,5
6,3 - 10A	kA	100	6/50 ²⁾	3	2,5
10 - 16A	kA	10/100 ²⁾	6/50 ²⁾	2,5	2
16 - 20A	kA	10/100 ²⁾	6/50 ²⁾	2,5	2
20 - 25A	kA	10/100 ²⁾	6/50 ²⁾	2,5	2
25 - 32A	kA	10/100 ²⁾	6/50 ²⁾	2,5	2
Short circuit protection		220-240V AC	380-415V AC	500V AC	660-690V AC
Setting range					
to 1A	A	-	-	-	-
1 - 1,6A	A	-	-	-	-
1,6 - 2,5A	A	-	-	25	20
2,5 - 4A	A	-	-	35	25
4 - 6,3A	A	-	-	50	35
6,3 - 10A	A	-	80	50	35
10 - 16A	A	80	80	63	35
16 - 20A	A	80	80	63	50
20 - 25A	A	80	80	63	50
25 - 32A	A	80	80	63	50
Maximum ambient temperature					
Operation	open °C		-25 to +55		
Temperature compensation	enclosed °C		-25 to +40		
	°C		-20 to +55		
Power loss					
at rated current, warm condition	W	6 - 8			
Auxiliary Contacts					
Rated insulation voltage U_i	V~	500			
Thermal rated current I_{th} Ambient temperature max. 50°C	A	6			
Utilization category AC15					
Rated operational current I_e					
220-240V	A	3,5			
380-415V	A	2			
500V	A	1			
Short circuit protection					
max. fuse size	gL (gG) A	6			
Cable cross-section					
Main connector					
solid or stranded	mm ²	0,75 - 4			
flexible	mm ²	0,75 - 2,5			
flexible with multicore cable end	mm ²	0,75 - 2,5			
Cables per clamp		2			
Auxiliary connector					
solid or stranded	mm ²	0,75 - 2,5			
flexible	mm ²	0,75 - 1,5			
flexible with multicore cable end	mm ²	0,75 - 1,5			
Cables per clamp		2			
Resistance to shock according to IEC 68-2-27					
Operation	g / ms	4 / 11			
Solidity	g / ms	30 / 18			

1) Suitable for: earthed-neutral systems, overvoltage category I to III, pollution degree 3 (standard-industry): $U_{imp} = 6kV$.

2) with current limiter MBS25-ID50 up to 415V AC

Manual Motor Starters

Dimensions

Manual Motor Starter MU25A

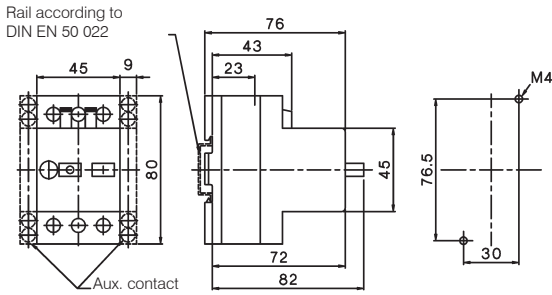

Moulded Enclosure MU25A-O55

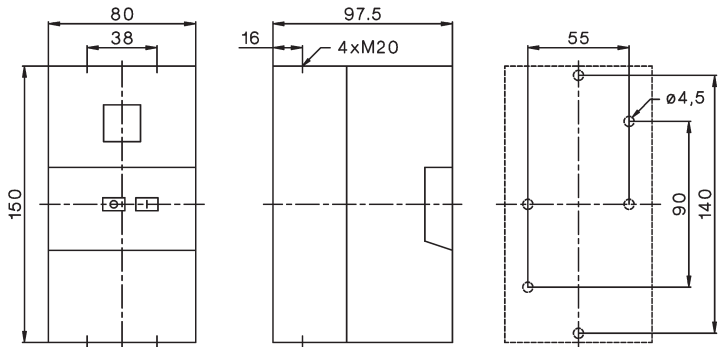

Moulded Front Plate MU25A-C55

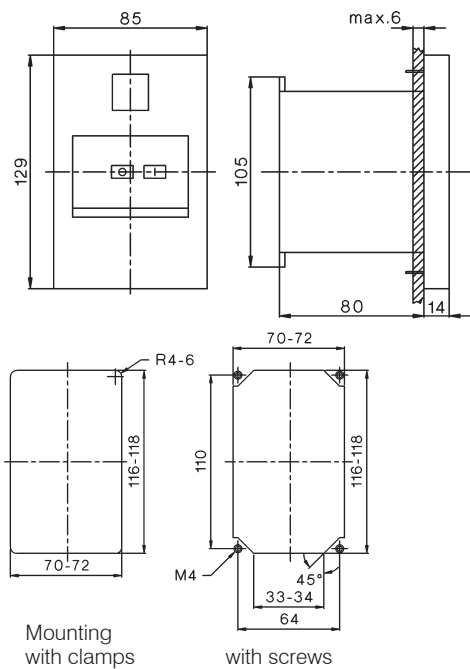

Moulded Enclosure for 5-pole CEE-plug MU25A-GC1

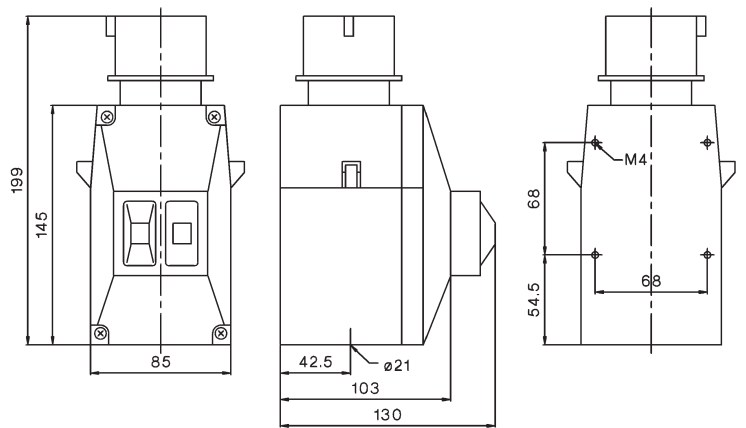

Temperature Compensation

In case of higher ambient temperature use the following formula:
(Ambient temperature - 20) x 0,3 = correction factor in % of the full load motor current

Example: Ambient temperature 60°C, full load motor current 5A
 $(60 - 20) \times 0,3 = 12\%$
Setting value: 5A + 12% = 5,6A

Tripping Characteristic

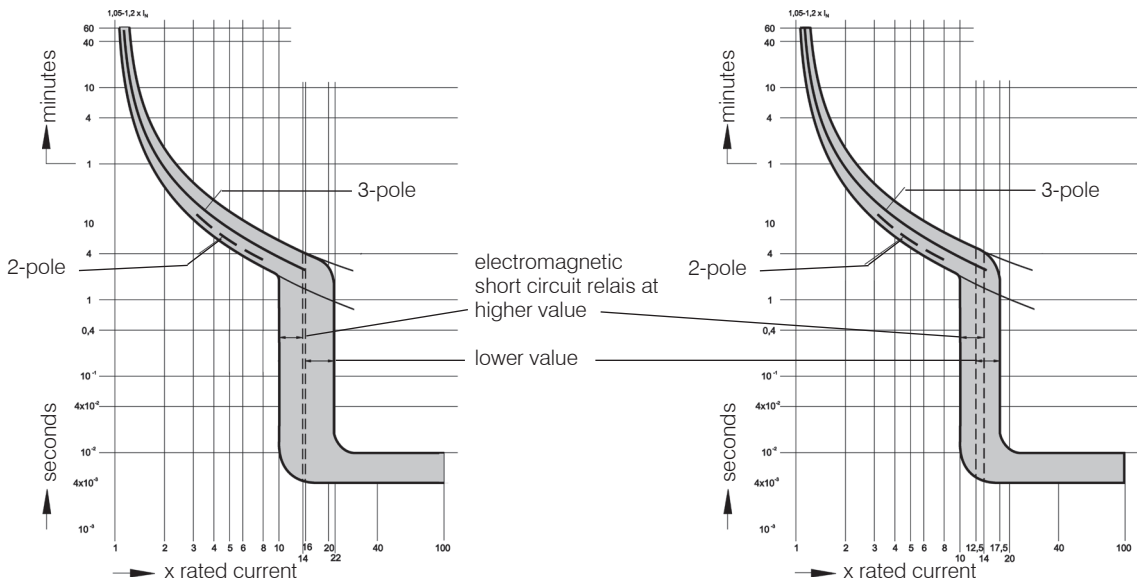

System MU25A

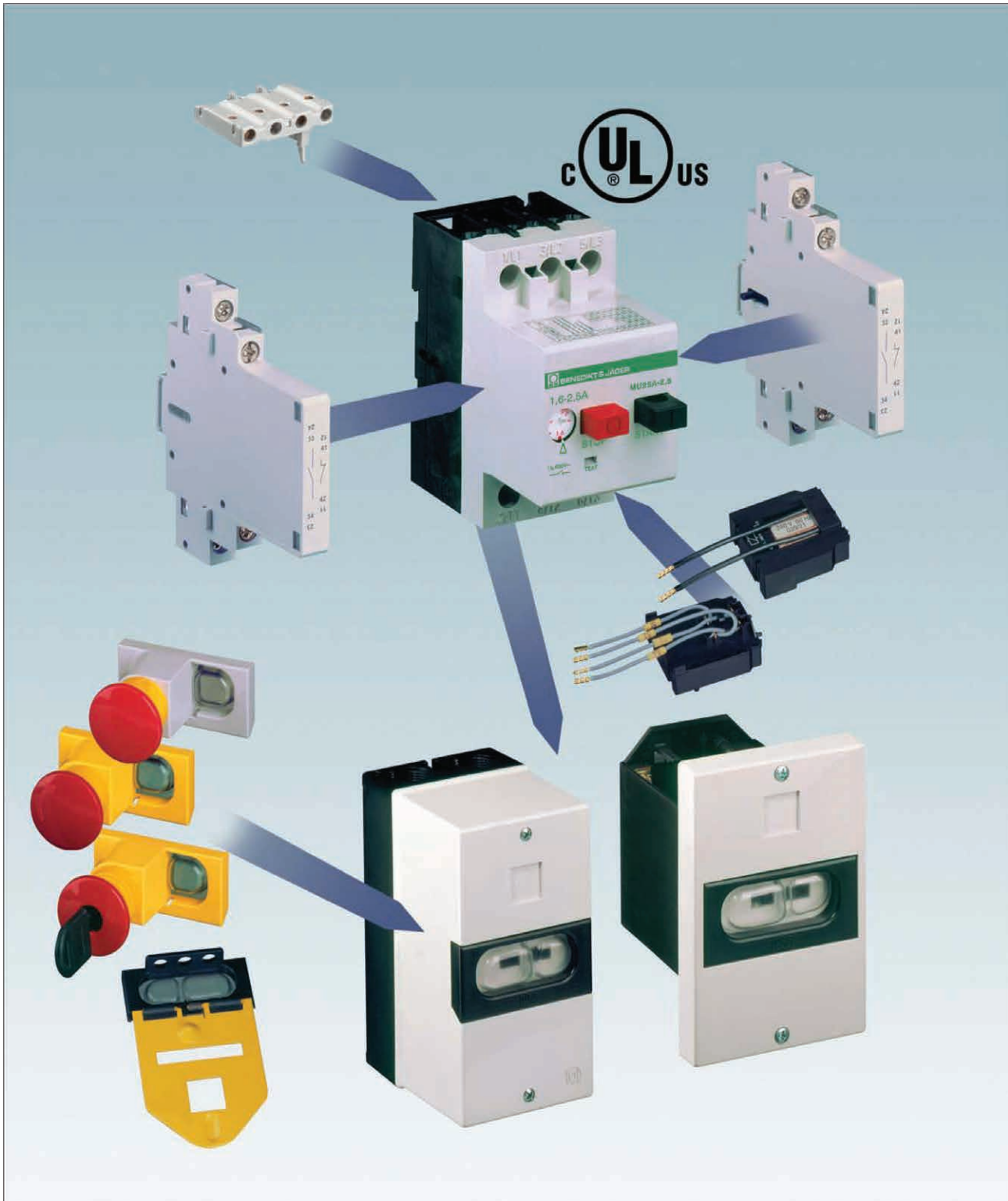

Approvals

Country	USA, Canada UL cUL [®] US LISTED	Switzerland SEV Ⓢ	Europe CE	CB/CCA- Certificates
Type				
MU25A	o	o	/	-

o In standard version approved / No testing required CE x In test - Not provided for test till now

	General	194
	Approvals	195
	Informations	196
	Cam Switches	198
	Basic designs	200
<hr/>		
	Cam Switches	203
	On-Off switches, Changeover switches	203
	Star-Delta switches	207
	Multi speed switches	211
	Control switches	215
	Voltmeter selector switches	218
	Ammeter switches	219
	Gang switches	221
	Multi step switches	224
		
<hr/>		
	Mini-Cam Switches	236
	Technical data	236
	On-Off switches, Changeover switches	237
	Star-Delta switches	237
	Control switches	237
	Voltmeter selector switches, Ammeter switches	238
	Gang switches, Multi step switches	238
		
<hr/>		
	Load switches	240
	On-Off switches	240
	Changeover switches	241
		
<hr/>		
	Handles and plates	242
	Operating knobs and handles	242
	Escutcheon plates	243
	Angles of rotation	247
<hr/>		
	Optional Extras	249
	Drive units	249
	Door couplings	250
	Key operated switches	251
	Padlock devices	252
	Switch interlocks	253
	Couplings	254
	Accessories	256
		
<hr/>		
	Special switches	257
<hr/>		
	Technical data	259
	Cam switches	259
	Load switches	260
<hr/>		
	Dimensions	262
	Cam switches	262
	Load switches	266
	Accessories	267

General

Test Authorities, Registration Mark, Approvals

Low voltage switchgear from Benedict GmbH is built and tested to national and international specifications. All devices suit all important specifications without any test obligation, like VDE, BS and also relative to IEC Recommendations and to European Standards like IEC 947 and EN 60947. It is for this reason of our Low voltage switchgear is used all over the world. In order to provide special versions, limitations to the max. voltages, currents and power ratings or special markings are sometimes necessary.

Quality Control System

Since November 1991 Benedict GmbH has been certified according to the quality control system **ÖNORM EN ISO 29001**. The target of the ISO-certification is, to grant the customer the quality of the performance of his supplier, who is audited in accordance with this standard.

CE-Marking



The manufacturer has to sign his products with the CE-Marking. With the CE-Marking the manufacturer confirms the accordance with the different EEC Directives. The CE-Marking is absolutely necessary to sell the products in the EEC.

Below you find the EEC Directives concerning our products.

Low Voltage Directive 2006/95/EC

EMC Directive 2004/108/EC

RoHS + WEEE 2002/95/EC + "002/96/EC

Country	North America	Russia
State deputy or private examination (state admitted)	UL Canada, USA	EAC
Label marking of examination boards	Listed Component	
Duty of approvals	all switchgear	all switchgear

Explanations for choice and supply of low voltage switchgear in Canada and USA

Marking of auxiliary contacts

At several devices in UL-data are two voltages for auxiliary contacts mentioned (e. g.: 600 volts at same potential, 150 volts at different potentials). That means, if the voltage is higher than 150 volts, the control voltage applied to input terminals must be at the same potential.

Low voltage switchgear for auxiliary circuits (e. g. contactor relays, control units, auxiliary contacts in general) usually approved for "Heavy Duty" or "Standard Duty" UL and besides these marked with the admissible max. voltage or with short codes (see table).

Marking of auxiliary contacts according to CSA and UL	Max. rated values per pole			Cont. Current A	Contact Rating Code Designation
	Voltage V	Current Make A	Break A		
Heavy Duty (HD or HVY DTY)	AC 120	60	6	10	A150
	AC 240	30	3	10	A300
	AC 480	15	1,5	10	A600
	AC 600	12	1,2	10	A600
	DC 125	2,2	2,2	10	N150
	DC 250	1,1	1,1	10	N300
	DC 600	0,4	0,4	10	N600
Standard Duty (SD or STD DTY)	AC 120	30	3	5	B150
	AC 240	15	1,5	5	B300
	AC 480	7,5	0,75	5	B600
	AC 600	6	0,6	5	B600
	DC 125	1,1	1,1	5	P150
	DC 250	0,55	0,55	5	P300
	DC 600	0,2	0,2	5	P600
-	AC 120	15	1,5	2,5	C150
	AC 240	7,5	0,75	2,5	C300
	AC 480	3,75	0,375	2,5	C600
	AC 600	3	0,3	2,5	C600
	DC 125	0,55	0,55	2,5	Q150
	DC 250	0,27	0,27	2,5	Q300
	DC 600	0,1	0,1	2,5	Q600
-	AC 120	3,6	0,6	1	D150
	AC 240	1,8	0,3	1	D300
	DC 125	0,22	0,22	1	R150
	DC 250	0,11	0,11	1	R300
-	AC 120	1,8	0,3	0,5	E150

Discernment at UL-Standards

Recognized Component Industrial Control Equipment

UL issues yellow "Guide cards" with Guide- and File-No.

Devices have permission to be marked with on the label



Devices as components approved for "factory wiring": devices for employment in control panels, when they are selected, mounted and wired according to the charging conditions by skilled worker.

Valid UL-Standards:
UL 508 "Standard for Industrial Control Equipment" (partly limited)

Listed Industrial Control Equipment

UL issues white "Guide cards" with Guide- and File-No.

Devices have to be marked with the "UL-Listing Mark"



Devices approved for "field wiring",
a) devices for employment in control panels, when they are mounted and wired by skilled worker.
b) devices for retail in USA

Valid UL-Standards:
UL 508 "Standard for Industrial Control Equipment" (unlimited)

Are devices approved as "Listed Equipment" the approval is also valid for using as "Recognized Component" .

Approvals

Country	USA, Canada UL	Europe	Russia EAC	CB/CCA- Certificates
Type				

Cam Switches (UL-Listed as MANUAL MOTOR CONTROLLER and suitable as MOTOR DISCONNECT)

M10	o	o	o	o
M10H	o	o	o	o
M20	o	o	o	o
N20	o	o	o	o
N33F	o	o	o	o
N40	-	o	o	o
N61	-	o	o	o
N80	o	o	o	o
N100	o	o	o	o
N200	o	o	o	o
L400	o	o	-	-

o In standard version approved / No testing required CE x In test
 - Not provided for test till now

Technical Information

Degree of protection acc. to IEC 60947-1

Protection ratings are prefixed by the internationally agreed letters IP followed by two digits.

1st digit: Pertains to solid objects
2nd digit: Pertains to water.

1 st digit	Short description	Definition
1	Protected against solid objects greater than 50 mm	Excludes solid objects exceeding 50 mm in diameter and protects against contact with live and moving parts by a large surface such as a hand (but not against deliberate access).
2L	Protected against solid objects greater than 12,5 mm and against contact by standard test finger	Excludes solid objects exceeding 12,5 mm in diameter and protects against contact with live and moving parts by a standard test finger or similar objects not exceeding 80 mm in length.
3	Protected against solid objects	Excludes solid objects exceeding 2,5 mm in diameter or thickness. greater than 2,5mm
4	Protected against solid objects greater than 1 mm	Excludes solid objects exceeding 1 mm in diameter or thickness.
5	Dust protected	Prevents ingress of dust in quantities and locations that would interfere with the intended operation of the equipment.
6	Dust tight	Prevents ingress of dust.

Resistance to climatic conditions acc. to IEC60068

Open-type devices are climate-resistant in the constant climate according to IEC60068-2-3 (this is a climate with an ambient temperature of 40°C and an atmospheric humidity of 90 to 95%).

Enclosed devices are climate-resistant in an alternating climate according to IEC 68-2-30 (this is a moist alternating climate with a 24-hour cycle between climates with an ambient temperature of 25°C, and an atmospheric humidity of 95 to 100% and an ambient temperature of 40°C, and an atmospheric humidity of 90 to 96% in the presence of condensation during rises in temperature).

Data are valid up to an altitude of 2000m above sea level.

Short circuit protection

Backup fuses should be used to protect contactors and starters against short circuits. For starters the device with the smaller admissible fuse at the main and at the control circuit (contactor or thermal overload) determines the fuse size.

After a short circuit devices have to be checked for correct operation. Disconnect power before proceeding with any work on the equipment!

Mounting positions

No limitations, all kind of positions allowed.













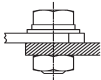



2 nd digit	Short description	Definition
1	Protected against dripping water	Dripping water (vertically falling drops) shall have no harmful effect.
2	Protected against dripping water when tilted up to 15°	Vertically dripping water shall have no harmful effect when the enclosure is tilted at any angle up to 15° from its normal position.
3	Protected against spraying water	Water falling as a spray at an angle up to 60° from the vertical shall have no harmful effect.
4	Protected against splashing water	Water splashed against the enclosure from any direction shall have no harmful effect.
5	Protected against water jets	Water protected by a nozzle against the enclosure from any direction shall have no harmful effect.
6	Protected against heavy seas	Water from heavy seas or water projected in powerful jets shall not enter the enclosure in harmful quantities.
7	Protected against the effects of immersion	Ingress of water in a harmful quantity shall not be possible when the enclosure is immersed in water under standard conditions of pressure and time.
8	Protected against submersion	No ingress of water.

Suitable ambient temperatures:

Operation	open °C	-40 up to +60
	enclosed °C	-40 up to +40
Storage	°C	-50 up to +90

Technical Information

Terminal screws

Devices Type	Kind of connection				Screw driver	Tightening torque	
	Screw with washer	Screw with clamp box	2 Screw s	Screw with w. nut		Nm	lb. inch
							
Cam Switches							
M4H..	M2,5	-	-	-	 Pz1	0,6	5
M10	M3	-	-	-	 Pz2	0,6 - 1,2	5 - 11
M10H	M3,5	-	-	-	 Pz2	0,8 - 1,4	7 - 12
M20, N20, N33F	M4	-	-	-	 Pz2	1,2 - 1,8	11 - 16
N40	M5	-	-	-	 Pz2	2,5 - 3	22 - 26
N61, N80	-	-	2 x M5	-	 Pz2	2,5 - 3	22 - 26
N100	-	-	2 x M6	-	 Pz3	3,5 - 4,5	31 - 40
N200	-	-	-	M10		10	88
L100	-	-	2 x M5	-	 Pz2	2,5 - 3	22 - 26
L160	-	-	-	M8		4 - 6,5	35 - 57
L400	-	-	-	M12		16	140
L600	-	-	-	M16		24	210
L800	-	-	-	M16		24	210
L1200	-	-	-	M16		24	210

Telux - Cam Switches

Ratings								Designs			
Typ	Rated current			Motor			Plate	Panel mount. M10H, M20 IP65 IP40	Single hole mount. Ø22,5mm with Plate IP65	without Plate IP65	Flush mount. IP40
	Therm. I_{in} open A	AC21 A	atU _e V	AC3 3~400V kW	AC23 3~400V A	3 kW					
M4H	10	10	440	2,2	6	3	30□	M4H E	M4H Z	M4H ZO	-
M10H	20	20	690	5,5	16	7,5	48□	M10H E	M10H Z	M10H ZO	-
M10	20	20	440	5,5	16	7,5	48□	-	-	-	M10 UP
M20	32	32	690	11	30	15	48□	M20 E	M20 Z	M20 ZO	-
N20	32	32	690	11	30	15	64□	N20 E	-	-	-
N33F	50	50	690	15	45	22	64□	N33F E	N33F Z	-	-
N40	63	63	690	15	45	22	88□	N40 E	-	-	-
N61	90	85	690	25	60	30	88□	N61 E	-	-	-
N80	115	115	690	30	85	45	88□	N80 E	-	-	-
L100	125	125	690	15	45	22	88□	L100 E	-	-	-
L160	180	180	690	25	60	30	88□	L160 E	-	-	-
N100	150	150	690	40	110	55	132□	N100 E	-	-	-
N200	250	250	690	70	140	70	132□	N200 E	-	-	-
L400	400	400	690	70	140	70	132□	L400 E	-	-	-
L600	600	400	690	70	140	70	132□	L600 E	-	-	-
L800	800	400	690	70	140	70	132□	L800 E	-	-	-
L1200	1200	400	690	70	140	70	132□	L1200 E	-	-	-

Cam Switches 10 - 250A

Cam switches can be used for virtually all purposes, e.g. as motor, main, control or instrument switches. Over and above the switching programs mentioned in the list, an effectively limitless number of special programs can be implemented.

Load switch L.. 125 - 1200A

Load switches are primarily employed where resistive or slightly inductive current loads are to be switched on and off, or switching takes place without loading.

Load switches are assembled by parallel switching of two or more of cam switch contacts.

With customer built main terminal protection, load switch L.. can also be used as main switch.

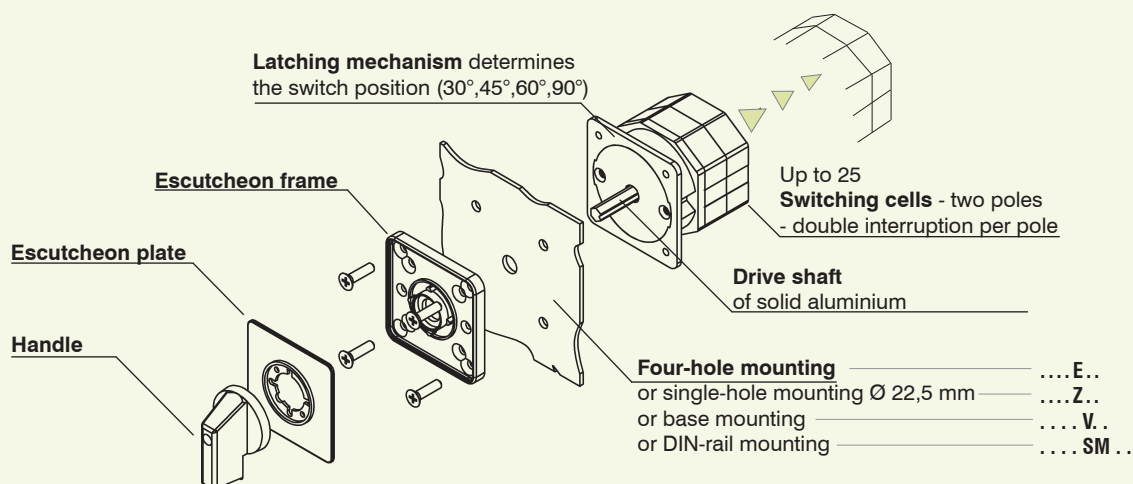

Designs Base mounting IP40	DIN-rail mounting IP40	Modular IP40	Plastic enclosed ..P.. IP40 ..PF.. IP65	horizontal, IP65	Motor switch enclosed IP65	Terminal box mounting IP65	Cast enclosed ..G.. IP40 ..GF.. IP65
-	-	-	-	-	-	-	-
M10H V ♦	M10H SM ♦	M10H SMA ♦	-	-	M10H PM ♦	-	-
-	-	-	M10 P(F) ♦	-	-	M10 KE ♦	-
M20 V ♦	M20 SM ♦	M20 SMA ♦	-	-	-	-	-
N20 V ♦	N20 SM ♦	-	N20 P(F) ♦	-	N20 PM ♦	N20 KE ♦	N20 G(F) ♦
N33F V ♦	N33F SM ♦	-	N33F P(F) ♦	-	N33F PM ♦	N33F KE ♦	-
N40 V ♦	-	-	N40 P(F) ♦	N40 PLF ♦	-	-	-
N61 V ♦	-	-	N61 P(F) ♦	N61 PLF ♦	-	-	-
N80 V ♦	-	-	N80 P(F) ♦	N80 PLF ♦	-	-	-
L100 V ♦	-	-	-	-	-	-	-
L160 V ♦	-	-	-	-	-	-	-
N100 V ♦	-	-	N100 PF ♦	-	-	-	-
N200 V ♦	-	-	N200 PF ♦	-	-	-	-
L400 V ♦	-	-	-	-	-	-	-
L600 V ♦	-	-	-	-	-	-	-
L800 V ♦	-	-	-	-	-	-	-
L1200 V ♦	-	-	-	-	-	-	-

Ordering

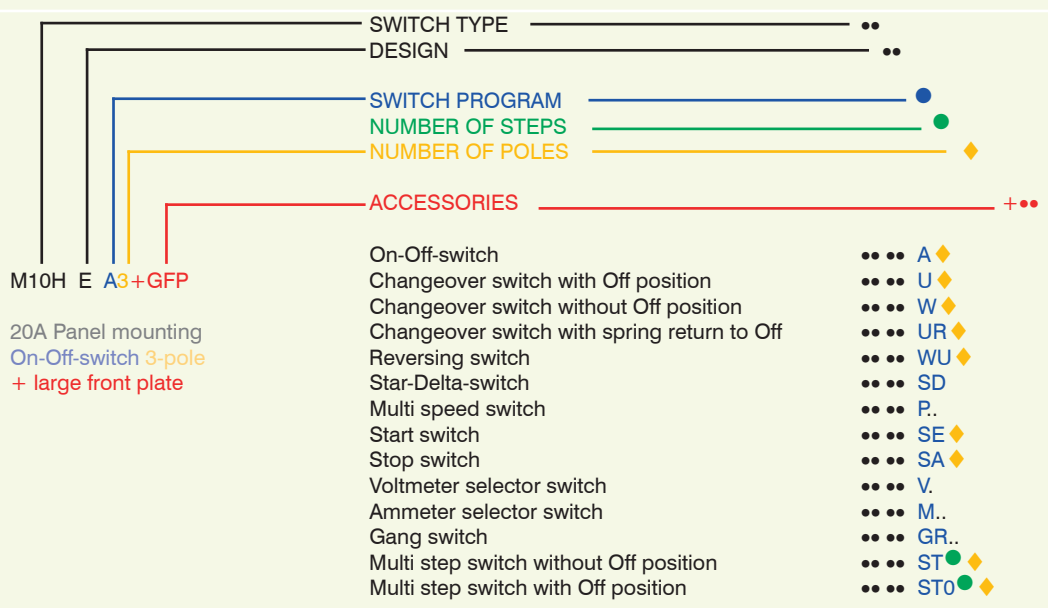

Panel mounting designs

Switches of the panel mounting designs listed below have protection from front IP40. Where a shaft seal (appendix +WD) is used, the protection is increased to IP54. Use of a moisture proofing cap (appendix +FR) results in an increase in rear protection to IP54. In the standard version, the switches are delivered with a square escutcheon plate and black instrument knob. Forward mounting is possible for some of the design

E switches. The position of the terminals of the standard switches is left and right, at switch M10H the terminals are above and below. Where a knob insert is turned by 90° (can easily be performed after delivery), the position of the terminals can be changed.

Dimensions see page 262.



Design	Description	Type appendix	Possible switch sizes					L...
			M10H	M20	N20 N33F	N40 N61 N80	N100 N200	
Panel mounting For installation in control panels, machines and equipment. For panel thickness of over 5mm, an extended switch shaft is required (appendix +VW). Protection from front: M10H, M20 IP65 all others IP40	E	X	X	X	X	X	X	
Central fixing 22,5mm Switch for mounting with standard 22,5mm mounting holes and 1-4mm panel thickness. Protection from front: IP65 Wrench J7049 necessary	Z	X	X	X ²⁾	-	-	-	
Central fixing 22,5mm Switch without escutcheon plate , for installation with standard 22,5mm mounting holes and 1-4mm panel thickness. Protection from front: IP65 Wrench J7049 necessary	ZO	X	X	-	-	-	-	
Flush mounting version Switch with white instrument knob, cream escutcheon plate with black markings, for installation in 65mm flush mounting boxes and use of Unitas plate. Supplied with flush mounting box: appendix +UP. Maximum number of cells with: M10 FM box 45mm deep 2 FM box 65mm deep 4	UP	X ¹⁾	-	-	-	-	-	

1) Switches are delivered with switch type M10





2) For switch types N33F only, max. 3 poles and 3 cells

Base mounting designs

Switches of the designs listed below have protection from front IP40. When a shaft seal (appendix +WD) is used, the front protection type is increased to IP54. In the standard version, the switches are delivered with a square escutcheon plate and black instrument knob (design SMA with grey cover and grey toggle knob). Door couplings are advisable for switchgear cabinets with hinged doors.

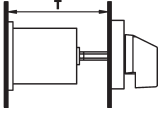
The position of the terminals of the standard switches is left and right, at switch M10H the terminals are above and below. Where a knob insert is turned by 90° (can easily be performed after delivery), the position of the terminals can be changed.

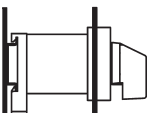
Dimensions see page 263.

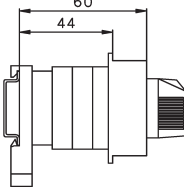
Design	Possible switch sizes	Possible switch sizes					
		Type appendix	M10H	M20	N20 N33F	N40 N61 N80	N100 N200
 <p>Base mounting For screw mounting to the back wall or floor of distributor boxes, or of appliances with removable lids. Additional it is necessary to state the installation depth - that is the distance between mounting level of the switch and the inside edge of the door (dimension T).</p>  <p>Door couplings see page 250</p>	V ... +T/...	X	X	X	X	X	X
 <p>Snap-on mounting on DIN-rail Switch with square escutcheon plate, for snap-on mounting on standard DIN EN 50022 rail. Additional it is necessary to state the installation depth - that is the distance between mounting level of the switch and the inside edge of the door (dimension T).</p>  <p>Door couplings see page 250</p>	SM ... +T/...	X	X	X	-	-	-
 <p>Snap-on mounting on DIN-rail with installation cover for standard opening and toggle knob. The lay-out of the terminals of the standard switches is above and below. Dimensions for Switch types M10H SMA .. with 1-3 cells M20 SMA .. with 1 or 2 cells</p>  <p>further dimensions see page 263</p>	SMA	X	X	-	-	-	-

Plastic enclosed switches







The switches, which have durable plastic enclosures, are intended for wall mounting or attachment to machines. In the standard version, they are supplied with a light-grey enclosure, square escutcheon plate, black markings on a silver background, and a black instrument knob. Other colours and colour combinations are available for most enclosure types. It is not possible to mount an additional rectangular plate. The enclosure base is equipped with 4 entry glands with heavy-gauge conduit threads (see drawings). In all types of plastic enclosures, two terminals that are connected and insulated from switch column can be provided for a PE conductor (appendix +PE). In addition, 1 or 2 pilot lamps (appendix +SL..) with neon lights can be installed.

Dimensions see page 264.

Cast aluminium enclosed switches

The switches with cast aluminium enclosures are intended for wall mounting or attachment to machines, under heavy-duty operating conditions. The switches are delivered with a square escutcheon plate, black markings on a silver background, and a black instrument knob. It is not possible to mount an additional rectangular plate. The enclosure base makes provision for 2 (4) entry glands with heavy-gauge conduit threads. If a switch with an aluminium enclosure is to be mounted directly on the terminal box of a motor, a 35mm or 50mm hole can be made in the floor of the switch enclosure. Design PLF is the replacement for designs G and GF at types N40 to N80.

Dimensions see page 265.

Design	Type appendix	Possible switch sizes							
		M10H	N20	N33F	N40	N61	N80	N100	N200
 Plastic enclosure light grey Protection class IP40 Maximum number of cells	P	X	X	X	X	X	-	-	-
		6	6	6	6	2			
 Plastic enclosure light grey Moisture protection Protection class IP65 Maximum number of cells	PF	X	X	X	X	X	X	X	X
		6	6	6	6	5	5	4	3
 Plastic enclosure horizontal light grey Moisture protection Protection class IP65 Maximum number of cells	PLF	-	-	-	X	X	X	-	-
		-	-	-	10	6	6		
 Cast enclosure Protection class IP40 Maximum number of cells	G	-	X	-	-	-	-	-	-
		-	6						
 Cast enclosure Moisture protection Protection class IP65 Maximum number of cells	GF	-	X	-	-	-	-	-	-
		-	6						
 Terminal box mounting Protection class IP65 These switches are front mounted on a terminal box. The switch cells protrude through a hole into the terminal compartment. Maximum number of cells	KE	X	X	X	-	-	-	-	-
		12	12	12					
 Plastic motor switch enclosure Moisture protection Protection class IP65 Maximum number of cells	PM	-	X	-	-	-	-	-	-
			6						

Switching programs

Description	Wiring diagram	Switching angle	Number of cells ↓ Size ↓ AC21	Type	Design see page 6-8 E. Z. V. SMA. P. G.	Switch pro- gram	Escutcheon plate	
On-Off-switches A								
1-pole		60°	1	48 □ 20A	M10H . x x x x x ¹⁾ - . A1	. A1		
				32A	M20 . x x x x - - . A1			
				64 □ 32A	N20 . x - x - x x . A1			+003
				50A	N33F . x x x - x - . A1			
				88 □ 63A	N40 . x - x - x - . A1			
90A	N61 . x - x - x - . A1							
115A	N80 . x - x - - - . A1							
132 □ 150A	N100 . x - x - - - . A1							
250A	N200 . x - x - - - . A1							
2-pole		60°	1	48 □ 20A	M10H . x x x x x ¹⁾ - . A2	. A2		
				32A	M20 . x x x x - - . A2			
				64 □ 32A	N20 . x - x - x x . A2			+003
				50A	N33F . x x x - x - . A2			
				88 □ 63A	N40 . x - x - x - . A2			
90A	N61 . x - x - x - . A2							
115A	N80 . x - x - - - . A2							
132 □ 150A	N100 . x - x - - - . A2							
250A	N200 . x - x - - - . A2							
3-pole		60°	2	48 □ 20A	M10H . x x x x x ¹⁾ - . A3	. A3		
				32A	M20 . x x x x - - . A3			
				64 □ 32A	N20 . x - x - x x . A3			+003
				50A	N33F . x x x - x - . A3			
				88 □ 63A	N40 . x - x - x - . A3			
90A	N61 . x - x - x - . A3							
115A	N80 . x - x - - - . A3							
132 □ 150A	N100 . x - x - - - . A3							
250A	N200 . x - x - - - . A3							
4-pole 4. pole early make		60°	2	48 □ 20A	M10H . x x x x x ¹⁾ - . A4	. A4		
				32A	M20 . x x x x - - . A4			
				64 □ 32A	N20 . x - x - x x . A4			+003
				50A	N33F . x - x - x - . A4			
				88 □ 63A	N40 . x - x - x - . A4			
90A	N61 . x - x - x - . A4							
115A	N80 . x - x - - - . A4							
132 □ 150A	N100 . x - x - - - . A4							
250A	N200 . x - x - - - . A4							
6-pole		60°	3	48 □ 20A	M10H . x x x x x x ¹⁾ - . A6	. A6		
				32A	M20 . x x x x x - - . A6			
				64 □ 32A	N20 . x - x - x x . A6			+003
				50A	N33F . x - x - x - . A6			
				88 □ 63A	N40 . x - x - x - . A6			
90A	N61 . x - x - x - . A6							
115A	N80 . x - x - - - . A6							
132 □ 150A	N100 . x - x - - - . A6							
250A	N200 . x - x - - - . A6							

Ordering example: AC21 250A panel mounting, On-Off-switch 6-pole, Escutcheon plate OFF - ON N200 E A6+003

1) Plastic enclosed switches are delivered with switch type M10.

Switching programs

Description	Wiring diagram	Switching angle	Number of cells ↓ Size ↓ AC21	Type	Design see page 6-8 E. Z. V. SMA. P. G.	Switch pro- gram	Escutcheon plate
Changeover switches U							
1-pole		60°	1 48 □ 20A 32A	M10H . M20 .	x x x x x ¹⁾ x x x x - -	. U1 . U1	
			64 □ 32A 50A	N20 . N33F .	x - x - x x x x x - x -	. U1 . U1	
			88 □ 63A 90A 115A	N40 . N61 . N80 .	x - x - x - x - x - x - x - x - - -	. U1 . U1 . U1	+007
			132 □ 150A 250A	N100 . N200 .	x - x - - - x - x - - -	. U1 . U1	
2-pole		60°	2 48 □ 20A 32A	M10H . M20 .	x x x x x ¹⁾ - x x x x - -	. U2 . U2	
			64 □ 32A 50A	N20 . N33F .	x - x - x x x x x - x -	. U2 . U2	
			88 □ 63A 90A 115A	N40 . N61 . N80 .	x - x - x - x - x - x - x - x - - -	. U2 . U2 . U2	+007
			132 □ 150A 250A	N100 . N200 .	x - x - - - x - x - - -	. U2 . U2	
3-pole		60°	3 48 □ 20A 32A	M10H . M20 .	x x x x x ¹⁾ - x x x x - -	. U3 . U3	
			64 □ 32A 50A	N20 . N33F .	x - x - x x x x x - x -	. U3 . U3	
			88 □ 63A 90A 115A	N40 . N61 . N80 .	x - x - x - x - x - x - x - x - - -	. U3 . U3 . U3	+007
			132 □ 150A 250A	N100 . N200 .	x - x - - - x - x - - -	. U3 . U3	
4-pole 4. pole early make		60°	4 48 □ 20A 32A	M10H . M20 .	x x x x x ¹⁾ - x x x x - -	. U4 . U4	
			64 □ 32A 50A	N20 . N33F .	x - x - x x x - x - x -	. U4 . U4	
			88 □ 63A 90A 115A	N40 . N61 . N80 .	x - x - x - x - x - x - x - x - - -	. U4 . U4 . U4	+007
			132 □ 150A 250A	N100 . N200 .	x - x - - - x - x - - -	. U4 . U4	
6-pole		60°	6 48 □ 20A 32A	M10H . M20 .	x x x - x ¹⁾ - x x x - - -	. U6 . U6	
			64 □ 32A 50A	N20 . N33F .	x - x - x x x - x - x -	. U6 . U6	
			88 □ 63A 90A 115A	N40 . N61 . N80 .	x - x - x - x - x - x - x - x - - -	. U6 . U6 . U6	+007
			132 □ 150A 250A	N100 . N200 .	x - x - - - x - x - - -	. U6 . U6	

Ordering example: AC21 250A panel mounting, changeover switch 6-pole, Escutcheon plate 1 - OFF - 2 **N200 E U6+007**

1) Plastic enclosed switches are delivered with switch type M10.

Switching programs

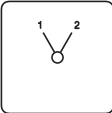
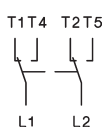
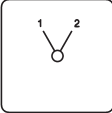
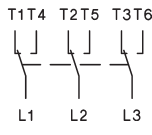
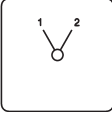
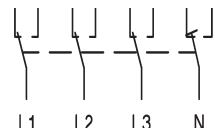
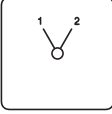
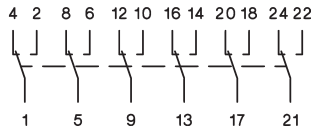
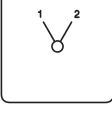
Description	Wiring diagram	Switching angle	Number of cells ↓ Size ↓ AC21	Type	Design see page 6-8 E. Z. V. SMA. P. G.	Switch pro- gram	Escutcheon plate
Changeover switches without off W							
1-pole		60°	1	48 □ 20A	M10H . x x x x x ¹⁾ - . W1 M20 . x x x x - - . W1		
				64 □ 32A	N20 . x - x - x x . W1 N33F . x x x - x - . W1		
				88 □ 63A	N40 . x - x - x - . W1 90A N61 . x - x - x - . W1 115A N80 . x - x - - - . W1		
				132 □ 150A	N100 . x - x - - - . W1 250A N200 . x - x - - - . W1		
2-pole		60°	2	48 □ 20A	M10H . x x x x x ¹⁾ - . W2 M20 . x x x x - - . W2		
				64 □ 32A	N20 . x - x - x x . W2 N33F . x x x - x - . W2		
				88 □ 63A	N40 . x - x - x - . W2 90A N61 . x - x - x - . W2 115A N80 . x - x - - - . W2		
				132 □ 150A	N100 . x - x - - - . W2 250A N200 . x - x - - - . W2		
3-pole		60°	3	48 □ 20A	M10H . x x x x x ¹⁾ - . W3 M20 . x x x x - - . W3		
				64 □ 32A	N20 . x - x - x x . W3 N33F . x x x - x - . W3		
				88 □ 63A	N40 . x - x - x - . W3 90A N61 . x - x - x - . W3 115A N80 . x - x - - - . W3		
				132 □ 150A	N100 . x - x - - - . W3 250A N200 . x - x - - - . W3		
4-pole 4. pole early make		60°	4	48 □ 20A	M10H . x x x x x ¹⁾ - . W4 M20 . x x x x - - . W4		
				64 □ 32A	N20 . x - x - x x . W4 N33F . x - x - x - . W4		
				88 □ 63A	N40 . x - x - x - . W4 90A N61 . x - x - x - . W4 115A N80 . x - x - - - . W4		
				132 □ 150A	N100 . x - x - - - . W4 250A N200 . x - x - - - . W4		
6-pole		60°	6	48 □ 20A	M10H . x x x x - x ¹⁾ - . W6 M20 . x x x x - - - . W6		
				64 □ 32A	N20 . x - x - x x . W6 N33F . x - x - x - . W6		
				88 □ 63A	N40 . x - x - x - . W6 90A N61 . x - x - x - . W6 115A N80 . x - x - - - . W6		
				132 □ 150A	N100 . x - x - - - . W6 250A N200 . x - x - - - . W6		

Ordering example: AC21 250A panel mounting, changeover switch without off 6-pole, **N200 E W6**

1) Plastic enclosed switches are delivered with switch type M10.



Switching programs

Description	Wiring diagram	Switching angle	Number of cells ↓ Size ↓ AC21	Type	Design see page 6-8 E. Z. V. SMA. P. G.	Switch pro- gram	Escutcheon plate
Reversing switches WU							
2-pole		60°	2	48 □ 20A	M10H . x x x x x ¹⁾ -	. WU2	
				32A	M20 . x x x x - -	. WU2	
				64 □ 32A	N20 . x - x - x x	. WU2	
				50A	N33F . x x x - x -	. WU2	
				88 □ 63A	N40 . x - x - x -	. WU2	
90A	N61 . x - x - x -	. WU2	+007				
115A	N80 . x - x - - -	. WU2					
132 □ 150A	N100 . x - x - - -	. WU2					
250A	N200 . x - x - - -	. WU2					
2-pole without off cross switch		60°	2	48 □ 20A	M10H . x x x x x ¹⁾ -	. WK2	
				32A	M20 . x x x x - -	. WK2	
				64 □ 32A	N20 . x - x - x x	. WK2	
				50A	N33F . x x x - x -	. WK2	
				88 □ 63A	N40 . x x - x -	. WK2	
90A	N61 . x - x - x -	. WK2					
115A	N80 . x - x - - -	. WK2					
132 □ 150A	N100 . x - x - - -	. WK2					
250A	N200 . x - x - - -	. WK2					
2-pole with spring return from both sides to off		30°	2	48 □ 20A	M10H . x x x x x ¹⁾ -	. WU2R2	
				32A	M20 . x x x x - -	. WU2R2	
				64 □ 32A	N20 . x - x - x x	. WU2R2	
50A	N33F . x x x - x -	. WU2R2					
88 □ 63A	N40 . x - x - x -	. WU2R2					
2-pole position 1 latched position 2 with spring return to off		60°+30°	2	48 □ 20A	M10H . x x x x x ¹⁾ -	. WU2R1	
				32A	M20 . x x x x - -	. WU2R1	
				64 □ 32A	N20 . x - x - x x	. WU2R1	
50A	N33F . x x x - x -	. WU2R1					
88 □ 63A	N40 . x - x - x -	. WU2R1					
3-pole		60°	3	48 □ 20A	M10H . x x x x x ¹⁾ -	. WU3	
				32A	M20 . x x x x - -	. WU3	
				64 □ 32A	N20 . x - x - x x	. WU3	
				50A	N33F . x x x - x -	. WU3	
				88 □ 63A	N40 . x - x - x -	. WU3	
90A	N60 . x - x - x -	. WU3	+007				
115A	N80 . x - x - - -	. WU3					
132 □ 150A	N100 . x - x - - -	. WU3					
250A	N200 . x - x - - -	. WU3					
3-pole with spring return from both sides to off		30°	3	48 □ 20A	M10H . x x x x x ¹⁾ -	. WU3R2	
				32A	M20 . x x x x - -	. WU3R2	
				64 □ 32A	N20 . x - x - x x	. WU3R2	
50A	N33F . x x x - x -	. WU3R2					
88 □ 63A	N40 . x - x x -	. WU3R2					
3-pole position 1 latched position 2 with spring return to off		60°+30°	3	48 □ 20A	M10H . x x x x x ¹⁾ -	. WU3R1	
				32A	M20 . x x x x - -	. WU3R1	
				64 □ 32A	N20 . x - x - x x	. WU3R1	
50A	N33F . x - x - x -	. WU3R1					
88 □ 63A	N40 . x - x - x -	. WU3R1					

Ordering example: AC21 63A base mounting, reversing switch 3-pole, position 2 with spring to off N40 V WU3R1

1) Plastic enclosed switches are delivered with switch type M10.

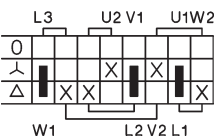
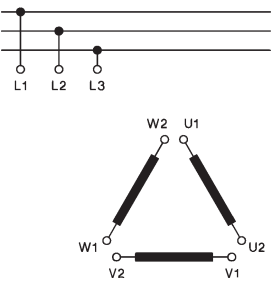
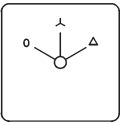
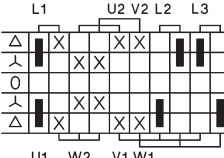
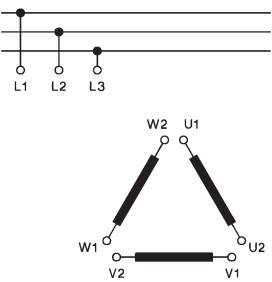
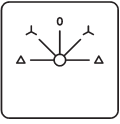
Switching programs

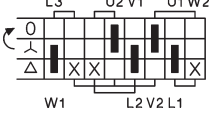
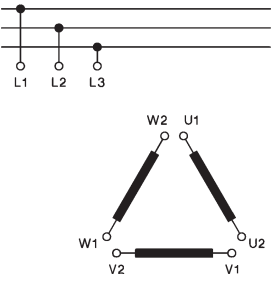
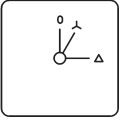
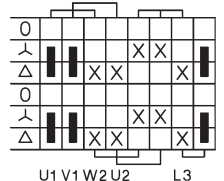
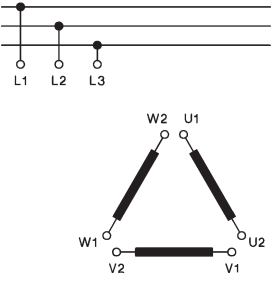
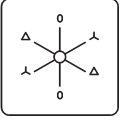
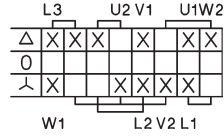
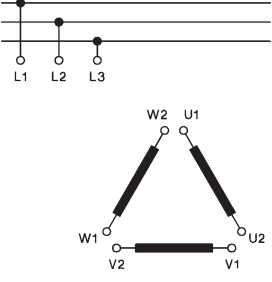
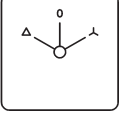
Description	Wiring diagram	Switching angle	Number of cells ↓ Size ↓ AC21	Type	Design see page 6-8 E. Z. V. SMA. P. G.	Switch pro- gram	Escutcheon plate
Star-Delta switches SD							
1 rotary direction 		60°	4	48 □ 20A 32A	M10H . x x x x x ¹⁾ - M20 . x x x x - -	. SD . SD	
			64 □ 32A 50A	N20 . x - x - x x N33F . x - x - x -	. SD . SD		
			88 □ 63A 90A 115A	N40 . x - x - x - N61 . x - x - x - N80 . x - x - - -	. SD . SD . SD		
			132 □ 150A 250A	N100 . x - x - - - N200 . x - x - - -	. SD . SD		
both rotary directions 		45°	5	48 □ 20A 32A	M10H . x x x x x ¹⁾ - M20 . x x x x - -	. SDR . SDR	
			64 □ 32A 50A	N20 . x - x - x x N33F . x - x - x -	. SDR . SDR		
			88 □ 63A 90A 115A	N40 . x - x - x - N61 . x - x - x - N80 . x - x - - -	. SDR . SDR . SDR		
			132 □ 150A 250A	N100 . x - x - - - N200 . x - x - - -	. SDR . SDR		
1 rotary direction spring return from  to off 		60°	4	48 □ 20A 32A	M10H . x x x x x ¹⁾ - M20 . x x x x - -	. SRD . SRD	
			64 □ 32A 50A	N20 . x - x - x x N33F . x - x - x -	. SRD . SRD		
			88 □ 63A 90A 115A	N40 . x - x - x - N60 . x - x - x - N80 . x - x - - -	. SRD . SRD . SRD		
			132 □ 150A 250A	N100 . x - x - - - N200 . x - x - - -	. SRD . SRD		
1 rotary direction with clockwise operation and backswitch interlock 		60°	5	48 □ 20A 32A	M10H . x x x x x ¹⁾ - M20 . x x x x - -	. SDRU . SDRU	
			64 □ 32A 50A	N20 . x - x - x x N33F . x - x - x -	. SDRU . SDRU		
			88 □ 63A 90A 115A	N40 . x - x - x - N60 . x - x - x - N80 . x - x - - -	. SDRU . SDRU . SDRU		
			132 □ 150A 250A	N100 . x - x - - - N200 . x - x - - -	. SDRU . SDRU		
Star-Delta selector switch 		60°	4	48 □ 20A 32A	M10H . x x x x x ¹⁾ - M20 . x x x x - -	. SDU . SDU	
			64 □ 32A 50A	N20 . x - x - x x N33F . x - x - x -	. SDU . SDU		
			88 □ 63A 90A 115A	N40 . x - x - x - N60 . x - x - x - N80 . x - x - - -	. SDU . SDU . SDU		
			132 □ 150A 250A	N100 . x - x - - - N200 . x - x - - -	. SDU . SDU		

Ordering example: AC21 32A cast enclosed, star-delta selector switch

N20 G SDU

1) Plastic enclosed switches are delivered with switch type M10.

Switching programs

Description	Wiring diagram	Switching angle	Number of cells ↓ Size ↓ AC21	Type	Design see page 6-8 E. Z. V. SMA. P. G.	Switch pro- gram	Escutcheon plate
with double outfeed phases for use with manual motor starter		60°	4 48 □ 20A 32A 64 □ 32A 50A 88 □ 63A 90A 115A 132 □ 150A 250A	M10H . M20 . N20 . N33F . N40 . N61 . N80 . N100 . N200 .	x x x x x ¹⁾ - x x x x - - x - x - x x x - x - x - x - x - x - x - x - x - x - x - - - x - x - - - x - x - - -	. SDMO . SDMO . SDMO . SDMO . SDMO . SDMO . SDMO . SDMO . SDMO	
with auxiliary contacts for contactor control, without main contacts, automatic zero setting in event of mains break- down		90°	4 48 □ 20A 32A 64 □ 32A 50A 88 □ 63A 90A 115A 132 □ 150A 250A	M10H . M20 . N20 . N33F . N40 . N61 . N80 . N100 . N200 .	x x x x x ¹⁾ - x x x x - - x - x - x x x - x - x - x - x - x - x - x - x - x - x - - - x - x - - - x - x - - -	. SDJ1 . SDJ1 . SDJ1 . SDJ1 . SDJ1 . SDJ1 . SDJ1 . SDJ1 . SDJ1	
with auxiliary contacts for contactor control, without main contacts, automatic zero setting in event of mains break- down, spring return to		90°+30°	4 48 □ 20A 32A 64 □ 32A 50A 88 □ 63A 90A 115A 132 □ 150A 250A	M10H . M20 . N20 . N33F . N40 . N61 . N80 . N100 . N200 .	x x x x x ¹⁾ - x x x x - - x - x - x x x - x - x - x - x - x - x - x - x - x - x - - - x - x - - - x - x - - -	. SDJ2 . SDJ2 . SDJ2 . SDJ2 . SDJ2 . SDJ2 . SDJ2 . SDJ2 . SDJ2	
as type SDJ1 but for both rotary directions		60°	7 48 □ 20A 32A 64 □ 32A 50A 88 □ 63A 90A 115A 132 □ 150A 250A	M10H . M20 . N20 . N33F . N40 . N61 . N80 . N100 . N200 .	x x x - - - x x x - - - x - x - x x x - x - - - x - x - x - x - x - - - x - x - - - x - x - - - x - x - - -	. SDRJ1 . SDRJ1 . SDRJ1 . SDRJ1 . SDRJ1 . SDRJ1 . SDRJ1 . SDRJ1 . SDRJ1	
with brake position (counter current braking) brake position is a momentary operation		45°+30°	5 48 □ 20A 32A 64 □ 32A 50A 88 □ 63A 90A 115A 132 □ 150A 250A	M10H . M20 . N20 . N33F . N40 . N61 . N80 . N100 . N200 .	x x x x x ¹⁾ - x x x x - - x - x - x x x - x - x - x - x - x - x - x - x - x - x - - - x - x - - - x - x - - -	. SDB . SDB . SDB . SDB . SDB . SDB . SDB . SDB . SDB	

Ordering example: AC21 250A panel mounting star-delta switch with brake position

N200 E SDB

1) Plastic enclosed switches are delivered with switch type M10.

Switching programs

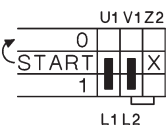
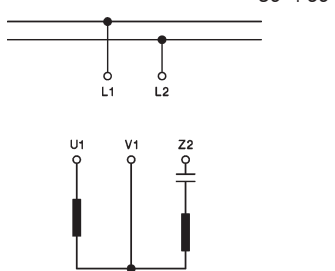
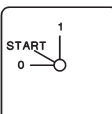
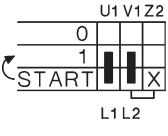
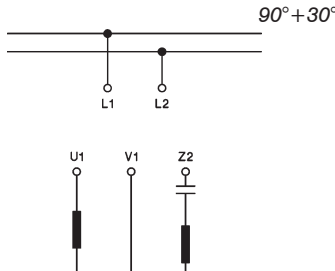
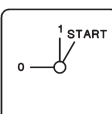
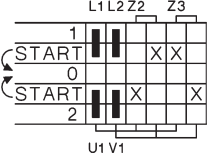
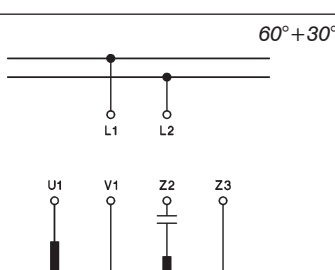
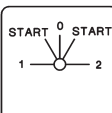
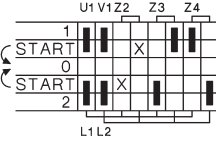
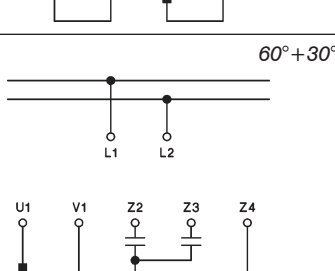
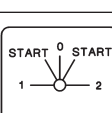
Description	Wiring diagram	Switching angle	Number of cells ↓ Size ↓ AC21	Type	Design see page 6-8 E. Z. V. SMA. P. G.	Switch pro- gram	Escutcheon plate
<p>for starting up single-phase motors with split-phase, spring return from START to Off</p> 	<p>30°+60°</p> 	<p>2</p>	<p>48 □ 20A 32A</p> <p>64 □ 32A 50A</p> <p>88 □ 63A</p>	<p>M10H . x x x x x¹⁾ - . HP1</p> <p>M20 . x x x x - - . HP1</p> <p>N20 . x - x - x x . HP1</p> <p>N33F . x - x - x - . HP1</p> <p>N40 . x - x - x - . HP1</p>			
<p>for starting up single-phase motors with split-phase, spring return from START to 1</p> 	<p>90°+30°</p> 	<p>2</p>	<p>48 □ 20A 32A</p> <p>64 □ 32A 50A</p> <p>88 □ 63A</p>	<p>M10H . x x x x x¹⁾ - . HP2</p> <p>M20 . x x x x - - . HP2</p> <p>N20 . x - x - x x . HP2</p> <p>N33F . x - x - x - . HP2</p> <p>N40 . x - x - x - . HP2</p>			
<p>for starting up single-phase motors with split-phase, both rotary directions</p> 	<p>60°+30°</p> 	<p>3</p>	<p>48 □ 20A 32A</p> <p>64 □ 32A 50A</p> <p>88 □ 63A</p>	<p>M10H . x x x x x¹⁾ - . HPR1</p> <p>M20 . x x x x - - . HPR1</p> <p>N20 . x - x - x x . HPR1</p> <p>N33F . x - x - x - . HPR1</p> <p>N40 . x - x - x - . HPR1</p>			
<p>as type HPR1 with starting and phase-shifting capacitor</p> 	<p>60°+30°</p> 	<p>4</p>	<p>48 □ 20A 32A</p> <p>64 □ 32A 50A</p> <p>88 □ 63A</p>	<p>M10H . x x x x x¹⁾ - . HPR2</p> <p>M20 . x x x x - - . HPR2</p> <p>N20 . x - x - x x . HPR2</p> <p>N33F . x - x - x - . HPR2</p> <p>N40 . x - x - x - . HPR2</p>			

Ordering example: AC21 63A panel mounting, split phase switch, both rotary directions **N40 E HPR1**

1) Plastic enclosed switches are delivered with switch type M10.

Switching programs

Description	Wiring diagram	Switching angle	Number of cells ↓ Size ↓ AC21	Type	Design see page 6-8 E. Z. V. SMA. P. G.	Switch pro- gram	Escutcheon plate
1 Dahlander winding 1 rotary direction 		60°	4	48 □ 20A 32A 64 □ 32A 50A 88 □ 63A 90A 115A 132 □ 150A 250A	M10H . x x x x x ¹⁾ - . P61 M20 . x x x x - - . P61 N20 . x - x - x x . P61 N33F . x - x - x - . P61 N40 . x - x - x - . P61 N61 . x - x - x - . P61 N80 . x - x - - - . P61 N100 . x - x - - - . P61 N200 . x - x - - - . P61		
1 Dahlander winding 1 rotary direction 		60°	4	48 □ 20A 32A 64 □ 32A 50A 88 □ 63A 90A 115A 132 □ 150A 250A	M10H . x x x x x ¹⁾ - . P62 M20 . x x x x - - . P62 N20 . x - x - x x . P62 N33F . x - x - x - . P62 N40 . x - x - x - . P62 N61 . x - x - x - . P62 N80 . x - x - - - . P62 N100 . x - x - - - . P62 N200 . x - x - - - . P62	 +007 	
1 Dahlander winding both rotary directions 		60°	7	48 □ 20A 32A 64 □ 32A 50A 88 □ 63A 90A 115A 132 □ 150A 250A	M10H . x x x - - - . P61R M20 . x x x - - - . P61R N20 . x - x - x - . P61R N33F . x - x - - - . P61R N40 . x - x - x - . P61R N61 . x - x - - - . P61R N80 . x - x - - - . P61R N100 . x - x - - - . P61R N200 . x - x - - - . P61R		
1 Dahlander winding 1 rotary direction, clockwise operation 		60°	5	48 □ 20A 32A 64 □ 32A 50A 88 □ 63A 90A 115A 132 □ 150A 250A	M10H . x x x x x ¹⁾ - . P61RU M20 . x x x x - - . P61RU N20 . x - x - x x . P61RU N33F . x - x - x - . P61RU N40 . x - x - x - . P61RU N61 . x - x - x - . P61RU N80 . x - x - - - . P61RU N100 . x - x - - - . P61RU N200 . x - x - - - . P61RU		
1 Dahlander winding 1 rotary direction, with auxiliary contacts for contactor control 		60°	5	48 □ 20A 32A 64 □ 32A 50A 88 □ 63A 90A 115A 132 □ 150A 250A	M10H . x x x x x ¹⁾ - . P61J M20 . x x x x - - . P61J N20 . x - x - x x . P61J N33F . x - x - x - . P61J N40 . x - x - x - . P61J N61 . x - x - x - . P61J N80 . x - x - - - . P61J N100 . x - x - - - . P61J N200 . x - x - - - . P61J		

Ordering example: AC21 32A cast enclosed, multi speed switch, 1 Dahlander winding, 1 rotary direction

N20 G P61

1) Plastic enclosed switches are delivered with switch type M10.

Switching programs

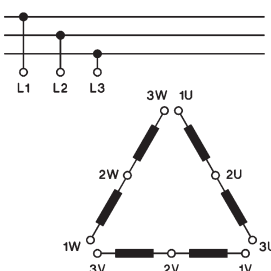
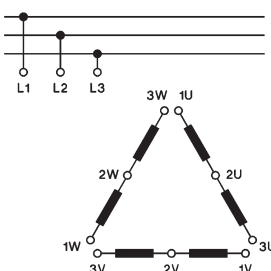
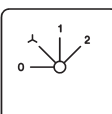
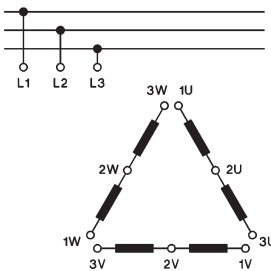
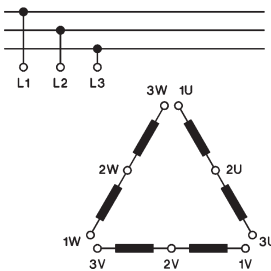
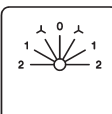
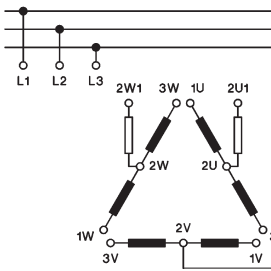
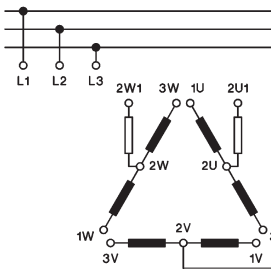
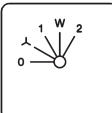
Description	Wiring diagram	Switching angle	Number of cells ↓ Size ↓ AC21	Type	Design see page 6-8 E. Z. V. SMA. P. G.	Switch pro- gram	Escutcheon plate
Multi speed switches P open Dahlander winding 1 rotary direction low speed with star-delta-start 		45°	6 48 □ 20A 32A 64 □ 32A 50A 88 □ 63A 90A 115A 132 □ 150A 250A	M10H . x x x - x ¹⁾ - . P91 M20 . x x x - - - . P91 N20 . x - x - x x . P91 N33F . x - x - x - . P91 N40 . x - x - x - . P91 N61 . x - x - x - . P91 N80 . x - x - - - . P91 N100 . x - x - - - . P91 N200 . x - x - - - . P91			
open Dahlander winding both rotary directions low speed with star-delta-start 		30°	8 48 □ 20A 32A 64 □ 32A 50A 88 □ 63A 90A 115A 132 □ 150A 250A	M10H . x x x - - - . P91R M20 . x x x - - - . P91R N20 . x - x - x - . P91R N33F . x - x - - - . P91R N40 . x - x - x - . P91R N61 . x - x - - - . P91R N80 . x - x - - - . P91R N100 . x - x - - - . P91R N200 . x - x - - - . P91R			
open Dahlander winding 1 rotary direction, low speed with star-delta-start, with additional start position (starting resistor) 		30°	7 48 □ 20A 32A 64 □ 32A 50A 88 □ 63A 90A 115A 132 □ 150A 250A	M10H . x x x - - - . P91W M20 . x x x - - - . P91W N20 . x - x - x - . P91W N33F . x - x - - - . P91W N40 . x - x - x - . P91W N61 . x - x - - - . P91W N80 . x - x - - - . P91W N100 . x - x - - - . P91W N200 . x - x - - - . P91W			

Ordering example: AC21 250A panel mounting, multi speed switch, 1 rotary direction, low speed with star-delta-start

N200 E P91

1) Plastic enclosed switches are delivered with switch type M10.

Switching programs

Description	Wiring diagram	Switching angle	Number of cells ↓ Size ↓ AC21	Type	Design see page 6-8 E. Z. V. SMA. P. G.	Switch pro- gram	Escutcheon plate
2 separate windings 1 rotary direction 	60°	3	48 □ 20A 32A 64 □ 32A 50A 88 □ 63A 90A 115A 132 □ 150A 250A	M10H . x x x x x ¹⁾ - . P63 M20 . x x x x - - . P63 N20 . x - x - x x . P63 N33F . x - x - x - . P63 N40 . x - x - x - . P63 N61 . x - x - x - . P63 N80 . x - x - - - . P63 N100 . x - x - - - . P63 N200 . x - x - - - . P63			
2 separate windings 1 rotary direction 	60°	3	48 □ 20A 32A 64 □ 32A 50A 88 □ 63A 90A 115A 132 □ 150A 250A	M10H . x x x x x ¹⁾ - . P64 M20 . x x x x - - . P64 N20 . x - x - x x . P64 N33F . x - x - x - . P64 N40 . x - x - x - . P64 N61 . x - x - x - . P64 N80 . x - x - - - . P64 N100 . x - x - - - . P64 N200 . x - x - - - . P64	 +007 		
2 separate windings both rotary directions 	60°	5	48 □ 20A 32A 64 □ 32A 50A 88 □ 63A 90A 115A 132 □ 150A 250A	M10H . x x x x x ¹⁾ - . P66 M20 . x x x x - - . P66 N20 . x - x - x x . P66 N33F . x - x - x - . P66 N40 . x - x - x - . P66 N61 . x - x - x - . P66 N80 . x - x - - - . P66 N100 . x - x - - - . P66 N200 . x - x - - - . P66			
2 separate windings 1 opened 1 rotary direction 	60°	4	48 □ 20A 32A 64 □ 32A 50A 88 □ 63A 90A 115A 132 □ 150A 250A	M10H . x x x x x ¹⁾ - . P71 M20 . x x x x - - . P71 N20 . x - x - x x . P71 N33F . x - x - x - . P71 N40 . x - x - x - . P71 N61 . x - x - x - . P71 N80 . x - x - - - . P71 N100 . x - x - - - . P71 N200 . x - x - - - . P71			
2 separate windings 1 rotary direction low speed with star-delta-start 	45°	6	48 □ 20A 32A 64 □ 32A 50A 88 □ 63A 90A 115A 132 □ 150A 250A	M10H . x x x - x ¹⁾ - . P96 M20 . x x x - - - . P96 N20 . x - x - x x . P96 N33F . x - x - x - . P96 N40 . x - x - x - . P96 N61 . x - x - x - . P96 N80 . x - x - - - . P96 N100 . x - x - - - . P96 N200 . x - x - - - . P96			

Ordering example: AC21 250A panel mounting, multi speed switch, 2 separate windings, low speed with star-delta-start **N200 E P96**

1) Plastic enclosed switches are delivered with switch type M10.

Switching programs

Description	Wiring diagram	Switching angle	Number of cells ↓ Size ↓ AC21	Type	Design see page 6-8 E. Z. V. SMA. P. G.	Switch pro- gram	Escutcheon plate
Multi speed switches P							
2 separate windings 1 rotary direction both speeds with star-delta-start		45°	8 48 □ 20A	M10H . x x x - - - . P122			
			32A	M20 . x x x - - - . P122			
			64 □ 32A	N20 . x - x - x - . P122			
			50A	N33F . x - x - - - . P122			
1 Dahlander winding A 1 normal winding B 3 speeds 1 rotary direction 0-A Δ-B Δoder Δ-A Δ		45°	88 □ 63A	N40 . x - x - x - . P122			
			90A	N61 . x - x - - - . P122			
			115A	N80 . x - x - - - . P122			
			132 □ 150A	N100 . x - x - - - . P122			
250A	N200 . x - x - - - . P122						
1 Dahlander winding A 1 normal winding B 3 speeds 1 rotary direction 0-A Δ-B Δoder Δ-A Δ		45°	6 48 □ 20A	M10H . x x x - x ¹⁾ - . P93			
			32A	M20 . x x x - - - . P93			
			64 □ 32A	N20 . x - x - x x . P93			
			50A	N33F . x - x - x - . P93			
88 □ 63A	N40 . x - x - x - . P93						
	90A				N61 . x - x - x - . P93		
	115A				N80 . x - x - - - . P93		
	132 □ 150A				N100 . x - x - - - . P93		
250A	N200 . x - x - - - . P93						
1 Dahlander winding A 1 normal winding B 3 speeds 1 rotary direction 0-B Δoder Δ-A Δ-A Δ		45°	6 48 □ 20A	M10H . x x x - x ¹⁾ - . P94			
			32A	M20 . x x x - - - . P94			
			64 □ 32A	N20 . x - x - x - . P94			
			50A	N33F . x - x - x - . P94			
88 □ 63A	N40 . x - x - x - . P94						
	90A				N61 . x - x - x - . P94		
	115A				N80 . x - x - - - . P94		
	132 □ 150A				N100 . x - x - - - . P94		
250A	N200 . x - x - - - . P94						
1 Dahlander winding A 1 normal winding B 3 speeds 1 rotary direction 0-A Δ-A Δ-B Δoder Δ		45°	6 48 □ 20A	M10H . x x x - x ¹⁾ - . P95			
			32A	M20 . x x x - - - . P95			
			64 □ 32A	N20 . x - x - x x . P95			
			50A	N33F . x - x - x - . P95			
88 □ 63A	N40 . x - x - x - . P95						
	90A				N61 . x - x - x - . P95		
	115A				N80 . x - x - - - . P95		
	132 □ 150A				N100 . x - x - - - . P95		
250A	N200 . x - x - - - . P95						
1 Dahlander winding A 1 normal winding B 3 speeds both rotary directions		45°	9 48 □ 20A	M10H . x x x - - - . P93R			
			32A	M20 . x x x - - - . P93R			
			64 □ 32A	N20 . x - x - - - . P93R			
			50A	N33F . x - x - - - . P93R			
88 □ 63A	N40 . x - x - - - . P93R						
	90A				N61 . x - x - - - . P93R		
	115A				N80 . x - x - - - . P93R		
	132 □ 150A				N100 . x - x - - - . P93R		
250A	N200 . x - x - - - . P93R						

Ordering example: AC21 250A panel mounting, multi speed switch, 1 Dahlander winding A,
1 normal winding B, 3 speeds, both rotary directions **N200 E P93R**

1) Plastic enclosed switches are delivered with switch type M10.

Switching programs

Description	Wiring diagram	Switching angle	Number of cells ↓ Size ↓ AC21	Type	Design see page 6-8 E. Z. V. SMA. P. G.	Switch pro- gram	Escutcheon plate
1 Dahlander winding A 1 normal winding B 3 speeds both rotary directions		45°	9 48 □ 20A	M10H . x x x - - - . P94R M20 . x x x - - - . P94R			
			64 □ 32A	N20 . x - x - - - . P94R N33F . x - x - - - . P94R			
			88 □ 63A	N40 . x - x - - - . P94R N61 . x - x - - - . P94R N80 . x - x - - - . P94R			
			132 □ 150A	N100 . x - x - - - . P94R N200 . x - x - - - . P94R			
			250A				
1 Dahlander winding A 1 normal winding B 3 speeds both rotary directions		45°	8 48 □ 20A	M10H . x x x - - - . P95R M20 . x x x - - - . P95R			
			64 □ 32A	N20 . x - x - x - . P95R N33F . x - x - - - . P95R			
			88 □ 63A	N40 . x - x - x - . P95R N61 . x - x - - - . P95R N80 . x - x - - - . P95R			
			132 □ 150A	N100 . x - x - - - . P95R N200 . x - x - - - . P95R			
			250A				
2 Dahlander windings 4 speeds 1 rotary direction O - A Δ - B Δ - A ∞ - B ∞		30°	8 48 □ 20A	M10H . x x x - - - . P124 M20 . x x x - - - . P124			
			64 □ 32A	N20 . x - x - x - . P124 N33F . x - x - - - . P124			
			88 □ 63A	N40 . x - x - x - . P124 N61 . x - x - - - . P124 N80 . x - x - - - . P124			
			132 □ 150A	N100 . x - x - - - . P124 N200 . x - x - - - . P124			
			250A				
2 Dahlander windings 4 speeds both rotary directions		30°	12 48 □ 20A	M10H . x x x - - - . P124R M20 . x x x - - - . P124R			
			64 □ 32A	N20 . x - x - - - . P124R N33F . x - x - - - . P124R			
			88 □ 63A	N40 . x - x - - - . P124R N61 . x - x - - - . P124R N80 . x - x - - - . P124R			
			132 □ 150A	N100 . x - x - - - . P124R N200 . x - x - - - . P124R			
			250A				

Ordering example: AC21 250A Base mounting, multi speed switch, 2 Dahlander windings, 4 speeds, 1 rotary direction

N200 V P124

Switching programs

Description	Wiring diagram	Switching angle	Number of cells ↓ Size ↓ AC21	Type	Design see page 6-8 E. Z. V. SMA. P. G.	Switch pro- gram	Escutcheon plate
Changeover switches with spring return to off UR							
1-pole		30°	1 48 □ 20A	M10H . x x x x x ¹⁾ - . UR1 M20 . x x x x - - . UR1			
			64 □ 32A	N20 . x - x - x x . UR1 N33F . x - x - x - . UR1			
			88 □ 63A	N40 . x - x - x - . UR1			
							+264
2-pole		30°	2 48 □ 20A	M10H . x x x x x ¹⁾ - . UR2 M20 . x x x x - - . UR2			
			64 □ 32A	N20 . x - x - x x . UR2 N33F . x - x - x - . UR2			
			88 □ 63A	N40 . x - x - x - . UR2			
							+264
3-pole		30°	3 48 □ 20A	M10H . x x x x x ¹⁾ - . UR3 M20 . x x x x - - . UR3			
			64 □ 32A	N20 . x - x - x x . UR3 N33F . x - x - x - . UR3			
			88 □ 63A	N40 . x - x - x - . UR3			
							+264
Changeover switches with 1 latched and 1 momentary position UK							
1-pole position 1 latched position 2 with spring return		60°+30°	1 48 □ 20A	M10H . x x x x x ¹⁾ - . UK1 M20 . x x x x - - . UK1			
			64 □ 32A	N20 . x - x - x x . UK1 N33F . x - x - x - . UK1			
			88 □ 63A	N40 . x - x - x - . UK1			
2-pole position 1 latched position 2 with spring return		60°+30°	2 48 □ 20A	M10H . x x x x x ¹⁾ - . UK2 M20 . x x x x - - . UK2			
			64 □ 32A	N20 . x - x - x x . UK2 N33F . x - x - x - . UK2			
			88 □ 63A	N40 . x - x - x - . UK2			
3-pole position 1 latched position 2 with spring return		60°+30°	3 48 □ 20A	M10H . x x x x x ¹⁾ - . UK3 M20 . x x x x - - . UK3			
			64 □ 32A	N20 . x - x - x x . UK3 N33F . x - x - x - . UK3			
			88 □ 63A	N40 . x - x - x - . UK3			

Ordering example: AC21 63A panel mounting, changeover switch, position 1 latched, position 2 with spring return, 3-pole: **N40 E UK3**

1) Plastic enclosed switches are delivered with switch type M10.

Switching programs

Description	Wiring diagram	Switching angle	Number of cells ↓ Size ↓ AC21	Type	Design see page 6-8 E. Z. V. SMA. P. G.	Switch pro- gram	Escutcheon plate
-------------	----------------	-----------------	---	------	---	------------------------	---------------------

Double throw switches with spring return to off WR

1-pole		30°	1	48 □ 20A 32A	M10H . x x x x x ¹⁾ - . W1R M20 . x x x x - - . W1R	
			64 □ 32A 50A	N20 . x - x - x x . W1R N33F . x - x - x - . W1R		
			88 □ 63A	N40 . x - x - x - . W1R		
2-pole		30°	2	48 □ 20A 32A	M10H . x x x x x ¹⁾ - . W2R M20 . x x x x - - . W2R	
			64 □ 32A 50A	N20 . x - x - x x . W2R N33F . x - x - x - . W2R		
			88 □ 63A	N40 . x - x - x - . W2R		
3-pole		30°	3	48 □ 20A 32A	M10H . x x x x x ¹⁾ - . W3R M20 . x x x x - - . W3R	
			64 □ 32A 50A	N20 . x - x - x x . W3R N33F . x - x - x - . W3R		
			88 □ 63A	N40 . x - x - x - . W3R		

Start-Stop switches S

Start-switch, 1-pole		30°	1	48 □ 20A 32A	M10H . x x x x x ¹⁾ - . SE M20 . x x x x - - . SE	
			64 □ 32A 50A	N20 . x - x - x x . SE N33F . x - x - x - . SE		
Start-switch, 2-pole		30°	1	48 □ 20A 32A	M10H . x x x x x ¹⁾ - . S2E M20 . x x x x - - . S2E	
			64 □ 32A 50A	N20 . x - x - x x . S2E N33F . x - x - x - . S2E		
Start-switch, 3-pole		30°	2	48 □ 20A 32A	M10H . x x x x x ¹⁾ - . S3E M20 . x x x x - - . S3E	
			64 □ 32A 50A	N20 . x - x - x x . S3E N33F . x - x - x - . S3E		

Bestellbeispiel: AC21 50A base mounting, Start-switch, 3-pole

N33F V S3E

1) Plastic enclosed switches are delivered with switch type M10.

Switching programs

Description	Wiring diagram	Switching angle	Number of cells ↓ Size ↓ AC21	Type	Design see page 6-8 E. Z. V. SMA. P. G.	Switch pro- gram	Escutcheon plate
Start-Stop switches S							
Stop-switch, 1-pole		30°	1 48 □ 20A 32A 64 □ 32A 50A 88 □ 63A	M10H . x x x x x ^{x1)} - M20 . x x x x - -	. SA . SA		
Stop-switch, 2-pole		30°	1 48 □ 20A 32A 64 □ 32A 50A 88 □ 63A	M10H . x x x x x ^{x1)} - M20 . x x x x - -	. S2A . S2A		
Stop-switch, 3-pole		30°	2 48 □ 20A 32A 64 □ 32A 50A 88 □ 63A	M10H . x x x x x ^{x1)} - M20 . x x x x - -	. S3A . S3A		
Start-Stop-switch, 1-pole		30°	1 48 □ 20A 32A 64 □ 32A 50A	M10H . x x x x x ^{x1)} - M20 . x x x x - -	. SEA . SEA		
Start-Stop-switch, 1-pole position START with spring return to 1		90° + 30°	1 48 □ 20A 32A 64 □ 32A 50A	M10H . x x x x x ^{x1)} - M20 . x x x x - -	. S392 . S392		
Start-Stop-switch, 1-pole for reversing contactors		60° + 30°	2 48 □ 20A 32A 64 □ 32A 50A	M10H . x x x x x ^{x1)} - M20 . x x x x - -	. S2EA . S2EA		
Start-Stop-switch, 1-pole for reversing contactors with limit switches		30°	2 48 □ 20A 32A 64 □ 32A 50A	M10H . x x x x x ^{x1)} - M20 . x x x x - -	. S22 . S22		

Ordering example: AC21 50A panel mounting, Start-Stop-switch, 1-pole for reversing contactors

N33F E S2EA

1) Plastic enclosed switches are delivered with switch type M10.

Switching programs

Description	Wiring diagram	Switching angle	Number of cells ↓ Size ↓ AC21	Type	Design see page 6-8 E. Z. V. SMA. P. G.	Switch pro- gram	Escutcheon plate
-------------	----------------	-----------------	---	------	---	------------------------	---------------------

Voltmeter selector switches V

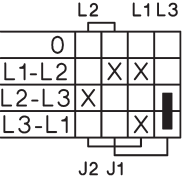
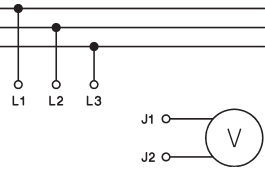
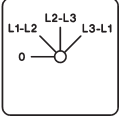
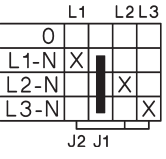
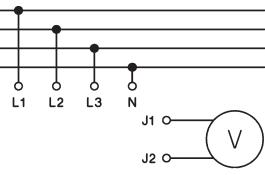
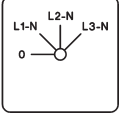
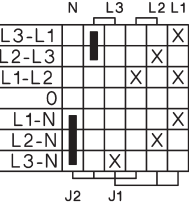
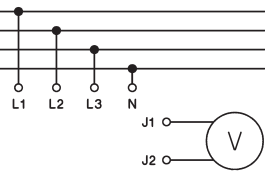
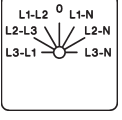
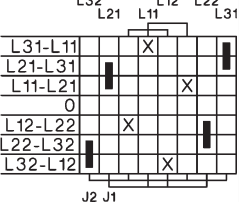
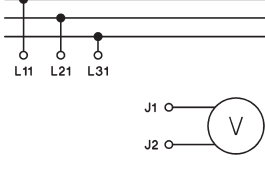
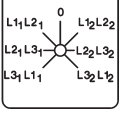
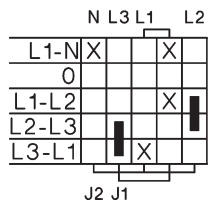
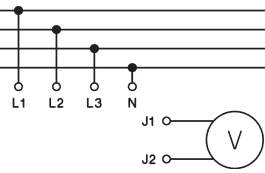
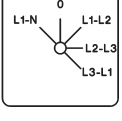
3 line voltages 		45°	2 48 □ 20A 32A 64 □ 32A 50A	M10H . x x x x x ¹⁾ - . V3 M20 . x x x x - - . V3 N20 . x - x - x x . V3 N33F . x x x - x - . V3	
3 phase voltages 		45°	2 48 □ 20A 32A 64 □ 32A 50A	M10H . x x x x x ¹⁾ - . V0 M20 . x x x x - - . V0 N20 . x - x - x x . V0 N33F . x x x - x - . V0	
3 line voltages and 3 phase voltages 		30°	3 48 □ 20A 32A 64 □ 32A 50A	M10H . x x x x x ¹⁾ - . V1 M20 . x x x x - - . V1 N20 . x - x - x x . V1 N33F . x x x - x - . V1	
2 3-phase systems 2 x 3 line voltages 		45°	4 48 □ 20A 32A 64 □ 32A 50A	M10H . x x x x x ¹⁾ - . V32 M20 . x x x x - - . V32 N20 . x - x - x x . V32 N33F . x - x - x - . V32	
3 line voltages and 1 phase voltage 		45°	3 48 □ 20A 32A 64 □ 32A 50A	M10H . x x x x x ¹⁾ - . V13 M20 . x x x x - - . V13 N20 . x - x - x x . V13 N33F . x x x - x - . V13	

Ordering example: AC21 50A panel mounting, Voltmeter selector switch, 3 line voltages and 1 phase voltage

N33F E V13

1) Plastic enclosed switches are delivered with switch type M10.

Switching programs

Description	Wiring diagram	Switching angle	Number of cells ↓ Size ↓ AC21	Type	Design see page 6-8 E. Z. V. SMA. P. G.	Switch program	Escutcheon plate
1-pole, for current transformer		90°	1	48 □ 20A 32A	M10H . x x x x x ¹⁾ - . M11 M20 . x x x x - - . M11		
				64 □ 32A 50A	N20 . x - x - x x . M11 N33F . x x x - x - . M11		
				88 □ 63A	N40 . x - x - x - . M11		
2-pole, for 1 current transformer or direct current measurement		90°	2	48 □ 20A 32A	M10H . x x x x x ¹⁾ - . M12 M20 . x x x x - - . M12		
				64 □ 32A 50A	N20 . x - x - x x . M12 N33F . x x x - x - . M12		
				88 □ 63A 90A 115A	N40 . x - x - x - . M12 N60 . x - x - x - . M12 N80 . x - x - - - . M12		
				132 □ 150A 250A	N100 . x - x - - - . M12 N200 . x - x - - - . M12		
1-pole, for 2 current transformers		90°	2	48 □ 20A 32A	M10H . x x x x x ¹⁾ - . M21 M20 . x x x x - - . M21		
				64 □ 32A 50A	N20 . x - x - x x . M21 N33F . x x x - x - . M21		
				88 □ 63A	N40 . x - x - x - . M21		
2-pole, for 2 current transformers or direct current measurement in 2 phases		90°	3	48 □ 20A 32A	M10H . x x x x x ¹⁾ - . M22 M20 . x x x x - - . M22		
				64 □ 32A 50A	N20 . x - x - x x . M22 N33F . x x x - x - . M22		
				88 □ 63A 90A 115A	N40 . x - x - x - . M22 N60 . x - x - x - . M22 N80 . x - x - - - . M22		
				132 □ 150A 250A	N100 . x - x - - - . M22 N200 . x - x - - - . M22		
1-pole, for 3 current transformers		90°	3	48 □ 20A 32A	M10H . x x x x x ¹⁾ - . M31 M20 . x x x x - - . M31		
			4	64 □ 32A 50A	N20 . x - x - x x . M31 N33F . x - x - x - . M31		
				88 □ 63A	N40 . x - x - x - . M31		

Ordering example: AC21 63A panel mounting, ammeter selector switch, for 3 current transformers 1-pole

N40 V M31

1) Plastic enclosed switches are delivered with switch type M10.

Switching programs

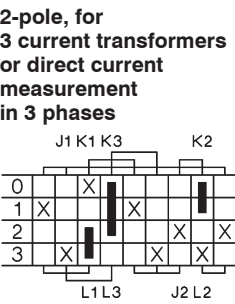
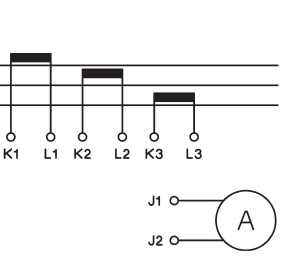
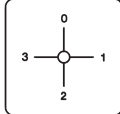
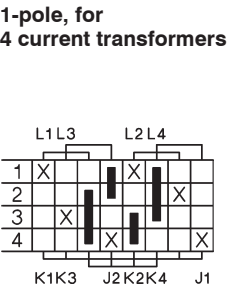
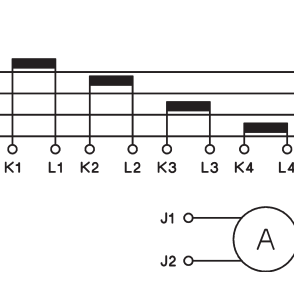
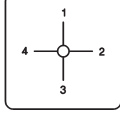
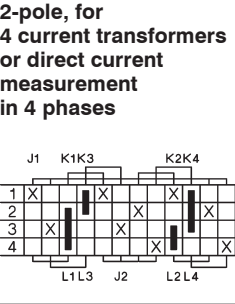
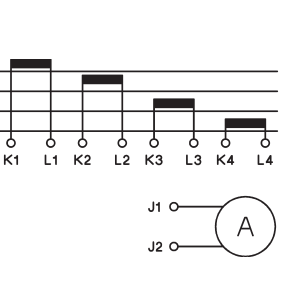
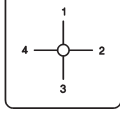
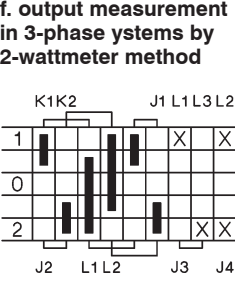
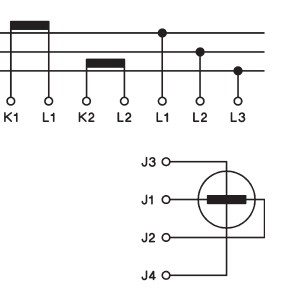
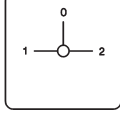
Description	Wiring diagram	Switching angle	Number of cells ↓ Size ↓ AC21	Type	Design see page 6-8 E. Z. V. SMA. P. G.	Switch pro- gram	Escutcheon plate
2-pole, for 3 current transformers or direct current measurement in 3 phases 		90°	6	48 □ 20A 32A	M10H . x x x x x ¹⁾ - . M32 M20 . x x x - - - . M32		
			64 □ 32A 50A	N20 . x - x - x x . M32 N33F . x - x - x - . M32			
			88 □ 63A 90A 115A	N40 . x - x - x - . M32 N61 . x - x - x - . M32 N80 . x - x - - - . M32			
			132 □ 150A 250A	N100 . x - x - - - . M32 N200 . x - x - - - . M32			
1-pole, for 4 current transformers 		90°	4	48 □ 20A 32A	M10H . x x x x x ¹⁾ - . M41 M20 . x x x x - - . M41		
			64 □ 32A 50A	N20 . x - x - x x . M41 N33F . x - x - x - . M41			
			88 □ 63A	N40 . x - x - x - . M41			
2-pole, for 4 current transformers or direct current measurement in 4 phases 		90°	6	48 □ 20A 32A	M10H . x x x x x ¹⁾ - . M42 M20 . x x x x - - . M42		
			64 □ 32A 50A	N20 . x - x - x x . M42 N33F . x - x - x - . M42			
			88 □ 63A 90A 115A	N40 . x - x - x - . M42 N61 . x - x - x - . M42 N80 . x - x - - - . M42			
			132 □ 150A 250A	N100 . x - x - - - . M42 N200 . x - x - - - . M42			
f. output measurement in 3-phase systems by 2-wattmeter method 		90°	5	48 □ 20A 32A	M10H . x x x x x ¹⁾ - . M2W M20 . x x x x - - . M2W		
			64 □ 32A 50A	N20 . x - x - x x . M2W N33F . x - x - x - . M2W			
			88 □ 63A 90A 115A	N40 . x - x - x - . M2W N61 . x - x - x - . M2W N80 . x - x - - - . M2W			
			132 □ 150A 250A	N100 . x - x - - - . M2W N200 . x - x - - - . M2W			

Ordering example: AC21 63A panel mounting, ammeter selector switch, for 4 current transformers 1-pole

N40 V M41

1) Plastic enclosed switches are delivered with switch type M10.

Switching programs

Description	Wiring diagram	Switching angle	Number of cells ↓ Size ↓ AC21	Type	Design see page 6-8 E. Z. V. SMA. P. G.	Switch pro- gram	Escutcheon plate
Gang switches GR							
2 circuits A and B 1-pole 0 - A - A+B 		45°	1 48 □ 20A	M10H . x x x x x ¹⁾ - . GR11 M20 . x x x x - - . GR11	. GR11 . GR11 . GR11 . GR11 . GR11 . GR11		
			64 □ 32A	N20 . x - x - x x . GR11 N33F . x x x - x - . GR11			
			88 □ 63A	N40 . x - x - x - . GR11 N61 . x - x - x - . GR11 N80 . x - x - - - . GR11			
			132 □ 150A	N100 . x - x - - - . GR11 N200 . x - x - - - . GR11			
2 circuits A and B 1-pole 0 - A - B - A+B 		45°	1 48 □ 20A	M10H . x x x x x ¹⁾ - . GR12 M20 . x x x x - - . GR12	. GR12 . GR12 . GR12 . GR12 . GR12 . GR12		
			64 □ 32A	N20 . x - x - x x . GR12 N33F . x x x - x - . GR12			
			88 □ 63A	N40 . x - x - x - . GR12 N61 . x - x - x - . GR12 N80 . x - x - - - . GR12			
			132 □ 150A	N100 . x - x - - - . GR12 N200 . x - x - - - . GR12			
2 circuits A and B 2-pole 0 - A - A+B 		45°	2 48 □ 20A	M10H . x x x x x ¹⁾ - . GR21 M20 . x x x x - - . GR21	. GR21 . GR21 . GR21 . GR21 . GR21 . GR21		
			64 □ 32A	N20 . x - x - x x . GR21 N33F . x x x - x - . GR21			
			88 □ 63A	N40 . x - x - x - . GR21 N61 . x - x - x - . GR21 N80 . x - x - - - . GR21			
			132 □ 150A	N100 . x - x - - - . GR21 N200 . x - x - - - . GR21			
2 circuits A and B 2-pole 0 - A - B - A+B 		45°	2 48 □ 20A	M10H . x x x x x ¹⁾ - . GR22 M20 . x x x x - - . GR22	. GR22 . GR22 . GR22 . GR22 . GR22 . GR22		
			64 □ 32A	N20 . x - x - x x . GR22 N33F . x x x - x - . GR22			
			88 □ 63A	N40 . x - x - x - . GR22 N61 . x - x - x - . GR22 N80 . x - x - - - . GR22			
			132 □ 150A	N100 . x - x - - - . GR22 N200 . x - x - - - . GR22			
2 circuits A and B 3-pole 0 - A - A+B 		45°	3 48 □ 20A	M10H . x x x x x x ¹⁾ - . GR31 M20 . x x x x - - . GR31	. GR31 . GR31 . GR31 . GR31 . GR31 . GR31		
			64 □ 32A	N20 . x - x - x x . GR31 N33F . x - x - x - . GR31			
			88 □ 63A	N40 . x - x - x x . GR31 N61 . x - x - x - . GR31 N80 . x - x - - - . GR31			
			132 □ 150A	N100 . x - x - - - . GR31 N200 . x - x - - - . GR31			

Ordering example: AC21 250A panel mounting, gang switch, 2 circuits A and B, 3-pole **N200 E GR31**

1) Plastic enclosed switches are delivered with switch type M10.

Switching programs

Description	Wiring diagram	Switching angle	Number of cells ↓ Size ↓ AC21	Type	Design see page 6-8 E. Z. V. SMA. P. G.	Switch pro- gram	Escutcheon plate
2 circuits A and B 3-pole 0 - A - B - A+B 		45°	3 48 □ 20A 32A 64 □ 32A 50A 88 □ 63A 90A 115A 132 □ 150A 250A	M10H . x x x x x ¹⁾ - . GR32 M20 . x x x x - - . GR32 N20 . x - x - x x . GR32 N33F . x - x - x - . GR32 N40 . x - x - x - . GR32 N61 . x - x - x - . GR32 N80 . x - x - - - . GR32 N100 . x - x - - - . GR32 N200 . x - x - - - . GR32			
3 circuits A, B and C 1-pole 0 - A - A+B - A+B+C 		45°	2 48 □ 20A 32A 64 □ 32A 50A 88 □ 63A 90A 115A 132 □ 150A 250A	M10H . x x x x x ¹⁾ - . GR14 M20 . x x x x - - . GR14 N20 . x - x - x x . GR14 N33F . x - x - x - . GR14 N40 . x - x - x - . GR14 N61 . x - x - x - . GR14 N80 . x - x - - - . GR14 N100 . x - x - - - . GR14 N200 . x - x - - - . GR14			
3 circuits A, B and C 2-pole 0 - A - A+B - A+B+C 		45°	3 48 □ 20A 32A 64 □ 32A 50A 88 □ 63A 90A 115A 132 □ 150A 250A	M10H . x x x x x ¹⁾ - . GR23 M20 . x x x x - - . GR23 N20 . x - x - x x . GR23 N33F . x - x - x - . GR23 N40 . x - x - x - . GR23 N61 . x - x - x - . GR23 N80 . x - x - - - . GR23 N100 . x - x - - - . GR23 N200 . x - x - - - . GR23			
3 circuits A, B and C 3-pole 0 - A - A+B - A+B+C 		45°	5 48 □ 20A 32A 64 □ 32A 50A 88 □ 63A 90A 115A 132 □ 150A 250A	M10H . x x x x x ¹⁾ - . GR33 M20 . x x x x - - . GR33 N20 . x - x - x x . GR33 N33F . x - x - x - . GR33 N40 . x - x - x - . GR33 N61 . x - x - x - . GR33 N80 . x - x - - - . GR33 N100 . x - x - - - . GR33 N200 . x - x - - - . GR33			

Ordering example: AC21 250A panel mounting, gang switch, 3 circuits A, B and C, 3-pole

N200 E GR33

1) Plastic enclosed switches are delivered with switch type M10.

Switching programs

Description	Wiring diagram	Switching angle	Number of cells ↓ Size ↓ AC21	Type	Design see page 6-8 E. Z. V. SMA. P. G.	Switch pro- gram	Escutcheon plate	
Series-Parallel switches SP								
2 circuits A and B 2-pole 0 - A + B - A,B (parallel)		45°	2	48 □ 20A	M10H . x x x x x ¹⁾ - . SP1	. SP1		
				64 □ 32A	N20 . x - x - x x . SP1			. SP1
				88 □ 63A	N33F . x x x - x - . SP1			
				132 □ 150A	N40 . x - x - x - . SP1			
90A	N61 . x - x - x - . SP1	. SP1						
115A	N80 . x - x - - - . SP1							
132 □ 250A	N100 . x - x - - - . SP1	. SP1						
	N200 . x - x - - - . SP1							
2 circuits A and B 2-pole 0 - A,B (parall.) - A - A+B		90°	3	48 □ 20A	M10H . x x x x x ¹⁾ - . SP4	. SP4		
				64 □ 32A	N20 . x - x - x x . SP4			. SP4
				88 □ 63A	N33F . x x x - x - . SP4			
				132 □ 150A	N40 . x - x - x - . SP4			
90A	N61 . x - x - x - . SP4	. SP4						
115A	N80 . x - x - - - . SP4							
132 □ 250A	N100 . x - x - - - . SP4	. SP4						
	N200 . x - x - - - . SP4							
2 circuits A and B for 3-phase systems 0 - A+B - A - B - A,B		30°	2	48 □ 20A	M10H . x x x x x ¹⁾ - . SP3	. SP3		
				64 □ 32A	N20 . x - x - x x . SP3			. SP3
				88 □ 63A	N33F . x x x - x - . SP3			
				132 □ 150A	N40 . x - x - x - . SP3			
90A	N61 . x - x - x - . SP3	. SP3						
115A	N80 . x - x - - - . SP3							
132 □ 250A	N100 . x - x - - - . SP3	. SP3						
	N200 . x - x - - - . SP3							

Ordering example: AC21 250A panel mounting, series-parallel switch, 2 circuits for 3-phase systems

N200 E SP3

1) Plastic enclosed switches are delivered with switch type M10.

Switching programs

Description	Wiring diagram	Switching angle	Number of cells ↓ Size ↓ AC21	Type	Design see page 6-8 E. Z. V. SMA. P. G.	Switch pro- gram	Escutcheon plate
Multi step switches 1-pole without Off ST.1							
3 steps		60°	2	48 □ 20A	M10H . x x x x x ¹⁾ -	. ST31	
				32A	M20 . x x x x - -	. ST31	
				64 □ 32A	N20 . x - x - x x	. ST31	
				50A	N33F . x x x - x -	. ST31	
				88 □ 63A	N40 . x - x - x -	. ST31	
90A	N61 . x - x - x -	. ST31					
115A	N80 . x - x - - -	. ST31					
132 □ 150A	N100 . x - x - - -	. ST31					
250A	N200 . x - x - - -	. ST31					
4 steps		60°	2	48 □ 20A	M10H . x x x x x ¹⁾ -	. ST41	
				32A	M20 . x x x x - -	. ST41	
				64 □ 32A	N20 . x - x - x x	. ST41	
				50A	N33F . x x x - x -	. ST41	
				88 □ 63A	N40 . x - x - x -	. ST41	
90A	N61 . x - x - x -	. ST41					
115A	N80 . x - x - - -	. ST41					
132 □ 150A	N100 . x - x - - -	. ST41					
250A	N200 . x - x - - -	. ST41					
5 steps		60°	3	48 □ 20A	M10H . x x x x x ¹⁾ -	. ST51	
				32A	M20 . x x x x - -	. ST51	
				64 □ 32A	N20 . x - x - x x	. ST51	
				50A	N33F . x x x - x -	. ST51	
				88 □ 63A	N40 . x - x - x -	. ST51	
90A	N61 . x - x - x -	. ST51					
115A	N80 . x - x - - -	. ST51					
132 □ 150A	N100 . x - x - - -	. ST51					
250A	N200 . x - x - - -	. ST51					
6 steps		60°	3	48 □ 20A	M10H . x x x x x ¹⁾ -	. ST61	
				32A	M20 . x x x x - -	. ST61	
				64 □ 32A	N20 . x - x - x x	. ST61	
				50A	N33F . x x x - x -	. ST61	
				88 □ 63A	N40 . x - x - x -	. ST61	
90A	N61 . x - x - x -	. ST61					
115A	N80 . x - x - - -	. ST61					
132 □ 150A	N100 . x - x - - -	. ST61					
250A	N200 . x - x - - -	. ST61					
7 steps		45°	4	48 □ 20A	M10H . x x x x x ¹⁾ -	. ST71	
				32A	M20 . x x x x - -	. ST71	
				64 □ 32A	N20 . x - x - x x	. ST71	
				50A	N33F . x - x - x -	. ST71	
				88 □ 63A	N40 . x - x - x -	. ST71	
90A	N61 . x - x - x -	. ST71					
115A	N80 . x - x - - -	. ST71					
132 □ 150A	N100 . x - x - - -	. ST71					
250A	N200 . x - x - - -	. ST71					

Ordering example: AC21 250A panel mounting, multi step switch 1-pole without off, 7 steps

N200 E ST71

1) Plastic enclosed switches are delivered with switch type M10.

Switching programs

Description	Wiring diagram	Switching angle	Number of cells ↓ Size ↓ AC21	Type	Design see page 6-8 E. Z. V. SMA. P. G.	Switch pro- gram	Escutcheon plate
Multi step switches 1-pole without Off ST.1							
8 steps		45°	4	48 □ 20A	M10H . x x x x x ¹⁾ - . ST81		
				32A	M20 . x x x x - - . ST81		
				64 □ 32A	N20 . x - x - x x . ST81		
				50A	N33F . x - x - x - . ST81		
				88 □ 63A	N40 . x - x - x - . ST81		
90A	N61 . x - x - x - . ST81						
115A	N80 . x - x - - - . ST81						
132 □ 150A	N100 . x - x - - - . ST81						
250A	N200 . x - x - - - . ST81						
9 steps		30°	5	48 □ 20A	M10H . x x x x x ¹⁾ - . ST91		
				32A	M20 . x x x x - - . ST91		
				64 □ 32A	N20 . x - x - x x . ST91		
				50A	N33F . x - x - x - . ST91		
				88 □ 63A	N40 . x - x - x - . ST91		
90A	N61 . x - x - x - . ST91						
115A	N80 . x - x - - - . ST91						
132 □ 150A	N100 . x - x - - - . ST91						
250A	N200 . x - x - - - . ST91						
10 steps		30°	5	48 □ 20A	M10H . x x x x x ¹⁾ - . ST101		
				32A	M20 . x x x x - - . ST101		
				64 □ 32A	N20 . x - x - x x . ST101		
				50A	N33F . x - x - x - . ST101		
				88 □ 63A	N40 . x - x - x - . ST101		
90A	N61 . x - x - x - . ST101						
115A	N80 . x - x - - - . ST101						
132 □ 150A	N100 . x - x - - - . ST101						
250A	N200 . x - x - - - . ST101						
11 steps		30°	6	48 □ 20A	M10H . x x x - x ¹⁾ - . ST111		
				32A	M20 . x x x - - - . ST111		
				64 □ 32A	N20 . x - x - x x . ST111		
				50A	N33F . x - x - x - . ST111		
				88 □ 63A	N40 . x - x - x - . ST111		
90A	N61 . x - x - x - . ST111						
115A	N80 . x - x - - - . ST111						
132 □ 150A	N100 . x - x - - - . ST111						
250A	N200 . x - x - - - . ST111						
12 steps		30°	6	48 □ 20A	M10H . x x x - x ¹⁾ - . ST121		
				32A	M20 . x x x - - - . ST121		
				64 □ 32A	N20 . x - x - x x . ST121		
				50A	N33F . x - x - x - . ST121		
				88 □ 63A	N40 . x - x - x - . ST121		
90A	N61 . x - x - x - . ST121						
115A	N80 . x - x - - - . ST121						
132 □ 150A	N100 . x - x - - - . ST121						
250A	N200 . x - x - - - . ST121						

Ordering example: AC21 250A panel mounting, multi step switch 1-pole without off, 12 steps

N200 E ST121

1) Plastic enclosed switches are delivered with switch type M10.

Switching programs

Description	Wiring diagram	Switching angle	Number of cells ↓ Size ↓ AC21	Type	Design see page 6-8 E. Z. V. SMA. P. G.	Switch pro- gram	Escutcheon plate
Multi step switches 1-pole with Off ST0.1							
2 steps		60°	1 48 □ 20A	M10H . x x x x x ¹⁾ - . ST021			
			32A	M20 . x x x x - - . ST021			
			64 □ 32A	N20 . x - x - x x . ST021			
			50A	N33F . x x x - x - . ST021			
			88 □ 63A	N40 . x - x - x - . ST021			
90A	N61 . x - x - x - . ST021						
115A	N80 . x - x - - - . ST021						
132 □ 150A	N100 . x - x - - - . ST021						
250A	N200 . x - x - - - . ST021						
+422							
3 steps		45°	2 48 □ 20A	M10H . x x x x x ¹⁾ - . ST031			
			32A	M20 . x x x x - - . ST031			
			64 □ 32A	N20 . x - x - x x . ST031			
			50A	N33F . x x x - x - . ST031			
			88 □ 63A	N40 . x - x - x - . ST031			
90A	N61 . x - x - x - . ST031						
115A	N80 . x - x - - - . ST031						
132 □ 150A	N100 . x - x - - - . ST031						
250A	N200 . x - x - - - . ST031						
+127							
4 steps		30°	2 48 □ 20A	M10H . x x x x x ¹⁾ - . ST041			
			32A	M20 . x x x x - - . ST041			
			64 □ 32A	N20 . x - x - x x . ST041			
			50A	N33F . x x x - x - . ST041			
			88 □ 63A	N40 . x - x - x - . ST041			
90A	N61 . x - x - x - . ST041						
115A	N80 . x - x - - - . ST041						
132 □ 150A	N100 . x - x - - - . ST041						
250A	N200 . x - x - - - . ST041						
+112							
5 steps		45°	3 48 □ 20A	M10H . x x x x x ¹⁾ - . ST051			
			32A	M20 . x x x x - - . ST051			
			64 □ 32A	N20 . x - x - x x . ST051			
			50A	N33F . x x x - x - . ST051			
			88 □ 63A	N40 . x - x - x - . ST051			
90A	N61 . x - x - x - . ST051						
115A	N80 . x - x - - - . ST051						
132 □ 150A	N100 . x - x - - - . ST051						
250A	N200 . x - x - - - . ST051						
+423							
6 steps		45°	4 48 □ 20A	M10H . x x x x x ¹⁾ - . ST061			
			32A	M20 . x x x x - - . ST061			
			64 □ 32A	N20 . x - x - x x . ST061			
			50A	N33F . x - x - x - . ST061			
			88 □ 63A	N40 . x - x - x - . ST061			
90A	N61 . x - x - x - . ST061						
115A	N80 . x - x - - - . ST061						
132 □ 150A	N100 . x - x - - - . ST061						
250A	N200 . x - x - - - . ST061						
+128							

Ordering example: AC21 250A panel mounting, multi step switch 1-pole with off, 6 steps

N200 E ST061

1) Plastic enclosed switches are delivered with switch type M10.

Switching programs

Description	Wiring diagram	Switching angle	Number of cells ↓ Size ↓ AC21	Type	Design see page 6-8 E. Z. V. SMA. P. G.	Switch pro- gram	Escutcheon plate
Multi step switches 1-pole with Off ST0.1							
7 steps		45°	4	48 □ 20A	M10H . x x x x x ¹⁾ - . ST071	. ST071	
				32A	M20 . x x x x - - . ST071		
				64 □ 32A	N20 . x - x - - x x . ST071		
				50A	N33F . x - x - - x - . ST071		
				88 □ 63A	N40 . x - x - - x - . ST071		
90A	N61 . x - x - - x - . ST071						
115A	N80 . x - x - - - - . ST071						
132 □ 150A	N100 . x - x - - - - . ST071						
250A	N200 . x - x - - - - . ST071						
8 steps		30°	5	48 □ 20A	M10H . x x x x x ¹⁾ - . ST081	. ST081	
				32A	M20 . x x x x - - . ST081		
				64 □ 32A	N20 . x - x - - x x . ST081		
				50A	N33F . x - x - - x - . ST081		
				88 □ 63A	N40 . x - x - - x - . ST081		
90A	N61 . x - x - - x - . ST081						
115A	N80 . x - x - - - - . ST081						
132 □ 150A	N100 . x - x - - - - . ST081						
250A	N200 . x - x - - - - . ST081						
9 steps		30°	5	48 □ 20A	M10H . x x x x x ¹⁾ - . ST091	. ST091	
				32A	M20 . x x x x - - . ST091		
				64 □ 32A	N20 . x - x - - x x . ST091		
				50A	N33F . x - x - - x - . ST091		
				88 □ 63A	N40 . x - x - - x - . ST091		
90A	N61 . x - x - - x - . ST091						
115A	N80 . x - x - - - - . ST091						
132 □ 150A	N100 . x - x - - - - . ST091						
250A	N200 . x - x - - - - . ST091						
10 steps		30°	6	48 □ 20A	M10H . x x x - - x ¹⁾ - . ST0101	. ST0101	
				32A	M20 . x x x - - - - . ST0101		
				64 □ 32A	N20 . x - x - - x x . ST0101		
				50A	N33F . x - x - - x - . ST0101		
				88 □ 63A	N40 . x - x - - x - . ST0101		
90A	N61 . x - x - - x - . ST0101						
115A	N80 . x - x - - - - . ST0101						
132 □ 150A	N100 . x - x - - - - . ST0101						
250A	N200 . x - x - - - - . ST0101						
11 steps		30°	6	48 □ 20A	M10H . x x x - - x ¹⁾ - . ST0111	. ST0111	
				32A	M20 . x x x - - - - . ST0111		
				64 □ 32A	N20 . x - x - - x x . ST0111		
				50A	N33F . x - x - - x - . ST0111		
				88 □ 63A	N40 . x - x - - x - . ST0111		
90A	N61 . x - x - - x - . ST0111						
115A	N80 . x - x - - - - . ST0111						
132 □ 150A	N100 . x - x - - - - . ST0111						
250A	N200 . x - x - - - - . ST0111						

Ordering example: AC21 250A panel mounting, multi step switch 1-pole with off, 11 steps

N200 E ST0111

1) Plastic enclosed switches are delivered with switch type M10.

Switching programs

Description	Wiring diagram	Switching angle	Number of cells ↓ Size ↓ AC21	Type	Design see page 6-8 E. Z. V. SMA. P. G.	Switch pro- gram	Escutcheon plate
Multi step switches 2-pole without Off ST.2							
3 steps		60°	3	48 □ 20A 32A	M10H . x x x x x ¹⁾ - M20 . x x x x - -	. ST32 . ST32	
			64 □ 32A 50A	N20 . x - x - x x N33F . x x x - x -	. ST32 . ST32		
			88 □ 63A 90A 115A	N40 . x - x - x - N61 . x - x - x - N80 . x - x - - -	. ST32 . ST32 . ST32		
			132 □ 150A 250A	N100 . x - x - - - N200 . x - x - - -	. ST32 . ST32		
			4 steps		60°	4	
64 □ 32A 50A	N20 . x - x - x x N33F . x - x - x -	. ST42 . ST42					
88 □ 63A 90A 115A	N40 . x - x - x - N61 . x - x - x - N80 . x - x - - -	. ST42 . ST42 . ST42					
132 □ 150A 250A	N100 . x - x - - - N200 . x - x - - -	. ST42 . ST42					
5 steps		60°	5			48 □ 20A 32A	M10H . x x x x x ¹⁾ - M20 . x x x x - -
64 □ 32A 50A			N20 . x - x - x x N33F . x - x - x -	. ST52 . ST52			
88 □ 63A 90A 115A			N40 . x - x - x - N61 . x - x - x - N80 . x - x - - -	. ST52 . ST52 . ST52			
132 □ 150A 250A			N100 . x - x - - - N200 . x - x - - -	. ST52 . ST52			
6 steps				60°	6	48 □ 20A 32A	M10H . x x x - x ¹⁾ - M20 . x x x - - -
64 □ 32A 50A	N20 . x - x - x x N33F . x - x - x -	. ST62 . ST62					
88 □ 63A 90A 115A	N40 . x - x - x - N61 . x - x - x - N80 . x - x - - -	. ST62 . ST62 . ST62					
132 □ 150A 250A	N100 . x - x - - - N200 . x - x - - -	. ST62 . ST62					
7 steps		45°			7	48 □ 20A 32A	M10H . x x x - - - M20 . x x x - - -
64 □ 32A 50A			N20 . x - x - x - N33F . x - x - - -	. ST72 . ST72			
88 □ 63A 90A 115A			N40 . x - x - x - N61 . x - x - - - N80 . x - x - - -	. ST72 . ST72 . ST72			
132 □ 150A 250A			N100 . x - x - - - N200 . x - x - - -	. ST72 . ST72			

Ordering example: AC21 250A panel mounting, multi step switch 2-pole without off, 7 steps

N200 E ST72

1) Plastic enclosed switches are delivered with switch type M10.

Switching programs

Description	Wiring diagram	Switching angle	Number of cells ↓ Size ↓ AC21	Type	Design see page 6-8 E. Z. V. SMA. P. G.	Switch pro- gram	Escutcheon plate
Multi step switches 2-pole without Off ST.2							
8 steps		45°	8 48 □ 20A	M10H . x x x - - - . ST82			
			32A	M20 . x x x - - - . ST82			
			64 □ 32A	N20 . x - x - x - . ST82			
			50A	N33F . x - x - - - . ST82			
88 □ 63A	N40 . x - x - x - . ST82						
90A	N61 . x - x - - - . ST82						
115A	N80 . x - x - - - . ST82						
132 □ 150A	N100 . x - x - - - . ST82						
250A	N200 . x - x - - - . ST82						
9 steps		30°	9 48 □ 20A	M10H . x x x - - - . ST92			
			32A	M20 . x x x - - - . ST92			
			64 □ 32A	N20 . x - x - - - . ST92			
			50A	N33F . x - x - - - . ST92			
88 □ 63A	N40 . x - x - - - . ST92						
90A	N61 . x - x - - - . ST92						
115A	N80 . x - x - - - . ST92						
132 □ 150A	N100 . x - x - - - . ST92						
250A	N200 . x - x - - - . ST92						
10 steps		30°	10 48 □ 20A	M10H . x x x - - - . ST102			
			32A	M20 . x x x - - - . ST102			
			64 □ 32A	N20 . x - x - - - . ST102			
			50A	N33F . x - x - - - . ST102			
88 □ 63A	N40 . x - x - - - . ST102						
90A	N61 . x - x - - - . ST102						
115A	N80 . x - x - - - . ST102						
132 □ 150A	N100 . x - x - - - . ST102						
250A	N200 . x - x - - - . ST102						
11 steps		30°	11 48 □ 20A	M10H . x x x - - - . ST112			
			32A	M20 . x x x - - - . ST112			
			64 □ 32A	N20 . x - x - - - . ST112			
			50A	N33F . x - x - - - . ST112			
88 □ 63A	N40 . x - x - - - . ST112						
90A	N61 . x - x - - - . ST112						
115A	N80 . x - x - - - . ST112						
132 □ 150A	N100 . x - x - - - . ST112						
250A	N200 . x - x - - - . ST112						
12 steps		30°	12 48 □ 20A	M10H . x x x - - - . ST122			
			32A	M20 . x x x - - - . ST122			
			64 □ 32A	N20 . x - x - - - . ST122			
			50A	N33F . x - x - - - . ST122			
88 □ 63A	N40 . x - x - - - . ST122						
90A	N61 . x - x - - - . ST122						
115A	N80 . x - x - - - . ST122						
132 □ 150A	N100 . x - x - - - . ST122						
250A	N200 . x - x - - - . ST122						

Ordering example: AC21 250A panel mounting, multi step switch 2-pole without off, 12 steps

N200 E ST122

Switching programs

Description	Wiring diagram	Switching angle	Number of cells ↓ Size ↓ AC21	Type	Design see page 6-8 E. Z. V. SMA. P. G.	Switch pro- gram	Escutcheon plate
Multi step switches 2-pole with Off ST0.2							
2 steps		60°	2 48 □ 20A	M10H . x x x x x ¹⁾ - . ST022 M20 . x x x x - - . ST022			
			64 □ 32A	N20 . x - x - x x . ST022 N33F . x x x - x - . ST022			
			88 □ 63A	N40 . x - x - x - . ST022 N61 . x - x - x - . ST022 N80 . x - x - - - . ST022			
			132 □ 150A	N100 . x - x - - - . ST022 N200 . x - x - - - . ST022			
3 steps		45°	3 48 □ 20A	M10H . x x x x x ¹⁾ - . ST032 M20 . x x x x - - . ST032			
			64 □ 32A	N20 . x - x - x x . ST032 N33F . x x x - x - . ST032			
			88 □ 63A	N40 . x - x - x - . ST032 N61 . x - x - x - . ST032 N80 . x - x - - - . ST032			
			132 □ 150A	N100 . x - x - - - . ST032 N200 . x - x - - - . ST032			
4 steps		30°	4 48 □ 20A	M10H . x x x x x ¹⁾ - . ST042 M20 . x x x x - - . ST042			
			64 □ 32A	N20 . x - x - x x . ST042 N33F . x - x - x - . ST042			
			88 □ 63A	N40 . x - x - x - . ST042 N61 . x - x - x - . ST042 N80 . x - x - - - . ST042			
			132 □ 150A	N100 . x - x - - - . ST042 N200 . x - x - - - . ST042			
5 steps		45°	6 48 □ 20A	M10H . x x x - x ¹⁾ - . ST052 M20 . x x x - - - . ST052			
			64 □ 32A	N20 . x - x - x x . ST052 N33F . x - x - x - . ST052			
			88 □ 63A	N40 . x - x - x - . ST052 N61 . x - x - x - . ST052 N80 . x - x - - - . ST052			
			132 □ 150A	N100 . x - x - - - . ST052 N200 . x - x - - - . ST052			
6 steps		45°	7 48 □ 20A	M10H . x x x - x ¹⁾ - . ST062 M20 . x x x - - - . ST062			
			64 □ 32A	N20 . x - x - x - . ST062 N33F . x - x - - - . ST062			
			88 □ 63A	N40 . x - x - x - . ST062 N61 . x - x - - - . ST062 N80 . x - x - - - . ST062			
			132 □ 150A	N100 . x - x - - - . ST062 N200 . x - x - - - . ST062			

Ordering example: AC21 250A panel mounting, multi step switch 2-pole with off, 6 steps

N200 E ST062

1) Plastic enclosed switches are delivered with switch type M10.

Switching programs

Description	Wiring diagram	Switching angle	Number of cells ↓ Size ↓ AC21	Type	Design see page 6-8 E. Z. V. SMA. P. G.	Switch pro- gram	Escutcheon plate
Multi step switches 2-pole with Off ST0.2							
7 steps		45°	8	48 □ 20A 32A	M10H . x x x - - - M20 . x x x - - -	. ST072 . ST072	
			64 □	32A 50A	N20 . x - x - x - N33F . x - x - - -	. ST072 . ST072	
			88 □	63A 90A 115A	N40 . x - x - x - N61 . x - x - - - N80 . x - x - - -	. ST072 . ST072 . ST072	
			132 □	150A 250A	N100 . x - x - - - N200 . x - x - - -	. ST072 . ST072	
8 steps		30°	9	48 □ 20A 32A	M10H . x x x - - - M20 . x x x - - -	. ST082 . ST082	
			64 □	32A 50A	N20 . x - x - - - N33F . x - x - - -	. ST082 . ST082	
			88 □	63A 90A 115A	N40 . x - x - - - N61 . x - x - - - N80 . x - x - - -	. ST082 . ST082 . ST082	
			132 □	150A 250A	N100 . x - x - - - N200 . x - x - - -	. ST082 . ST082	
9 steps		30°	10	48 □ 20A 32A	M10H . x x x - - - M20 . x x x - - -	. ST092 . ST092	
			64 □	32A 50A	N20 . x - x - - - N33F . x - x - - -	. ST092 . ST092	
			88 □	63A 90A 115A	N40 . x - x - - - N61 . x - x - - - N80 . x - x - - -	. ST092 . ST092 . ST092	
			132 □	150A 250A	N100 . x - x - - - N200 . x - x - - -	. ST092 . ST092	
10 steps		30°	11	48 □ 20A 32A	M10H . x x x - - - M20 . x x x - - -	. ST0102 . ST0102	
			64 □	32A 50A	N20 . x - x - - - N33F . x - x - - -	. ST0102 . ST0102	
			88 □	63A 90A 115A	N40 . x - x - - - N61 . x - x - - - N80 . x - x - - -	. ST0102 . ST0102 . ST0102	
			132 □	150A 250A	N100 . x - x - - - N200 . x - x - - -	. ST0102 . ST0102	
11 steps		30°	12	48 □ 20A 32A	M10H . x x x - - - M20 . x x x - - -	. ST0112 . ST0112	
			64 □	32A 50A	N20 . x - x - - - N33F . x - x - - -	. ST0112 . ST0112	
			88 □	63A 90A 115A	N40 . x - x - - - N61 . x - x - - - N80 . x - x - - -	. ST0112 . ST0112 . ST0112	
			132 □	150A 250A	N100 . x - x - - - N200 . x - x - - -	. ST0112 . ST0112	

Ordering example: AC21 250A panel mounting, multi step switch 2-pole with off, 11 steps N200 E ST0112

Switching programs

Description	Wiring diagram	Switching angle	Number of cells ↓ Size ↓ AC21	Type	Design see page 6-8 E. Z. V. SMA. P. G.	Switch pro- gram	Escutcheon plate
Multi step switches 3-pole without Off ST.3							
3 steps		60°	5	48 □ 20A 32A	M10H . x x x x x ¹⁾ - M20 . x x x x - -	. ST33 . ST33	
				64 □ 32A 50A	N20 . x - x - x x N33F . x - x - x -	. ST33 . ST33	
				88 □ 63A 90A 115A	N40 . x - x - x - N61 . x - x - x - N80 . x - x - - -	. ST33 . ST33 . ST33	
				132 □ 150A 250A	N100 . x - x - - - N200 . x - x - - -	. ST33 . ST33	
4 steps		60°	6	48 □ 20A 32A	M10H . x x x - x ¹⁾ - M20 . x x x - - -	. ST43 . ST43	
				64 □ 32A 50A	N20 . x - x - x x N33F . x - x - x -	. ST43 . ST43	
				88 □ 63A 90A 115A	N40 . x - x - x - N61 . x - x - x - N80 . x - x - - -	. ST43 . ST43 . ST43	
				132 □ 150A 250A	N100 . x - x - - - N200 . x - x - - -	. ST43 . ST43	
5 steps		60°	8	48 □ 20A 32A	M10H . x x x - - - M20 . x x x - - -	. ST53 . ST53	
				64 □ 32A 50A	N20 . x - x - x - N33F . x - x - - -	. ST53 . ST53	
				88 □ 63A 90A 115A	N40 . x - x - x - N61 . x - x - - - N80 . x - x - - -	. ST53 . ST53 . ST53	
				132 □ 150A 250A	N100 . x - x - - - N200 . x - x - - -	. ST53 . ST53	
6 steps		60°	9	48 □ 20A 32A	M10H . x x x - - - M20 . x x x - - -	. ST63 . ST63	
				64 □ 32A 50A	N20 . x - x - - - N33F . x - x - - -	. ST63 . ST63	
				88 □ 63A 90A 115A	N40 . x - x - - - N61 . x - x - - - N80 . x - x - - -	. ST63 . ST63 . ST63	
				132 □ 150A 250A	N100 . x - x - - - N200 . x - x - - -	. ST63 . ST63	
7 steps		45°	11	48 □ 20A 32A	M10H . x x x - - - M20 . x x x - - -	. ST73 . ST73	
				64 □ 32A 50A	N20 . x - x - - - N33F . x - x - - -	. ST73 . ST73	
				88 □ 63A 90A 115A	N40 . x - x - - - N61 . x - x - - - N80 . x - x - - -	. ST73 . ST73 . ST73	
				132 □ 150A 250A	N100 . x - x - - - N200 . x - x - - -	. ST73 . ST73	

Ordering example: AC21 250A panel mounting, multi step switch 3-pole without off, 7 steps

N200 E ST73

1) Plastic enclosed switches are delivered with switch type M10.

Switching programs

Description	Wiring diagram	Switching angle	Number of cells ↓ Size ↓ AC21	Type	Design see page 6-8 E. Z. V. SMA. P. G.	Switch pro- gram	Escutcheon plate
Multi step switches 3-pole without Off ST.3							
8 steps		45°	12 48 □ 20A	M10H . x x x - - - . ST83 M20 . x x x - - - . ST83			
			64 □ 32A	N20 . x - x - - - . ST83 N33F . x - x - - - . ST83			
			88 □ 63A	N40 . x - x - - - . ST83 90A N61 . x - x - - - . ST83 115A N80 . x - x - - - . ST83			
			132 □ 150A	N100 . x - x - - - . ST83 250A N200 . x - x - - - . ST83			
9 steps		30°	14 48 □ 20A	M10H . x - x - - - . ST93 M20 . x - x - - - . ST93			
			64 □ 32A	N20 . x - x - - - . ST93 N33F . x - x - - - . ST93			
			88 □ 63A	N40 . x - x - - - . ST93 90A N61 . x - x - - - . ST93 115A N80 . x - x - - - . ST93			
			132 □ 150A	N100 . x - x - - - . ST93 250A N200 . x - x - - - . ST93			
10 steps		30°	15 48 □ 20A	M10H . x - x - - - . ST103 M20 . x - x - - - . ST103			
			64 □ 32A	N20 . x - x - - - . ST103 N33F . x - x - - - . ST103			
			88 □ 63A	N40 . x - x - - - . ST103 90A N61 . x - x - - - . ST103 115A N80 . x - x - - - . ST103			
			132 □ 150A	N100 . x - x - - - . ST103 250A N200 . x - x - - - . ST103			
11 steps		30°	17 48 □ 20A	M10H . x - x - - - . ST113 M20 . x - x - - - . ST113			
			64 □ 32A	N20 . x - x - - - . ST113 N33F . x - x - - - . ST113			
			88 □ 63A	N40 . x - x - - - . ST113 90A N61 . x - x - - - . ST113 115A N80 . x - x - - - . ST113			
			132 □ 150A	N100 . x - x - - - . ST113 250A N200 . x - x - - - . ST113			
12 steps		30°	18 48 □ 20A	M10H . x - x - - - . ST123 M20 . x - x - - - . ST123			
			64 □ 32A	N20 . x - x - - - . ST123 N33F . x - x - - - . ST123			
			88 □ 63A	N40 . x - x - - - . ST123 90A N61 . x - x - - - . ST123 115A N80 . x - x - - - . ST123			
			132 □ 150A	N100 . x - x - - - . ST123 250A N200 . x - x - - - . ST123			

Ordering example: AC21 250A panel mounting, multi step switch 3-pole without off, 12 steps

N200 E ST123

Switching programs

Description	Wiring diagram	Switching angle	Number of cells ↓ Size ↓ AC21	Type	Design see page 6-8 E. Z. V. SMA. P. G.	Switch pro- gram	Escutcheon plate
Multi step switches 3-pole with Off ST0.3							
2 steps		60°	3	48 □ 20A	M10H . x x x x x ¹⁾ - . ST023 M20 . x x x x - - . ST023		
				64 □ 32A	N20 . x - x - x x . ST023 N33F . x x x - x - . ST023		
				88 □ 63A	N40 . x - x - x - . ST023 90A N61 . x - x - x - . ST023 115A N80 . x - x - - - . ST023		
				132 □ 150A	N100 . x - x - - - . ST023 250A N200 . x - x - - - . ST023		
				+422			
3 steps		45°	5	48 □ 20A	M10H . x x x x x ¹⁾ - . ST033 M20 . x x x x - - . ST033		
				64 □ 32A	N20 . x - x - x x . ST033 N33F . x - x - x - . ST033		
				88 □ 63A	N40 . x - x - x - . ST033 90A N61 . x - x - x - . ST033 115A N80 . x - x - - - . ST033		
				132 □ 150A	N100 . x - x - - - . ST033 250A N200 . x - x - - - . ST033		
				+127			
4 steps		30°	6	48 □ 20A	M10H . x x x - x ¹⁾ - . ST043 M20 . x x x - - - . ST043		
				64 □ 32A	N20 . x - x - x x . ST043 N33F . x - x - x - . ST043		
				88 □ 63A	N40 . x - x - x - . ST043 90A N61 . x - x - x - . ST043 115A N80 . x - x - - - . ST043		
				132 □ 150A	N100 . x - x - - - . ST043 250A N200 . x - x - - - . ST043		
				+112			
5 steps		45°	9	48 □ 20A	M10H . x x x - - - . ST053 M20 . x x x - - - . ST053		
				64 □ 32A	N20 . x - x - - - . ST053 N33F . x - x - - - . ST053		
				88 □ 63A	N40 . x - x - - - . ST053 90A N61 . x - x - - - . ST053 115A N80 . x - x - - - . ST053		
				132 □ 150A	N100 . x - x - - - . ST053 250A N200 . x - x - - - . ST053		
				+423			
6 steps		45°	11	48 □ 20A	M10H . x x x - - - . ST063 M20 . x x x - - - . ST063		
				64 □ 32A	N20 . x - x - - - . ST063 N33F . x - x - - - . ST063		
				88 □ 63A	N40 . x - x - - - . ST063 90A N61 . x - x - - - . ST063 115A N80 . x - x - - - . ST063		
				132 □ 150A	N100 . x - x - - - . ST063 250A N200 . x - x - - - . ST063		
				+128			

Ordering example: AC21 250A panel mounting, multi step switch 3-pole with off, 6 steps **N200 E ST063**

1) Plastic enclosed switches are delivered with switch type M10.

Switching programs

Description	Wiring diagram	Switching angle	Number of cells ↓ Size ↓ AC21	Type	Design see page 6-8 E. Z. V. SMA. P. G.	Switch pro- gram	Escutcheon plate
Multi step switches 3-pole with Off ST0.3							
7 steps		45°	12 48 □ 20A	M10H . x x x - - - . ST073 M20 . x x x - - - . ST073			
			64 □ 32A	N20 . x - x - - - . ST073 N33F . x - x - - - . ST073			
			88 □ 63A	N40 . x - x - - - . ST073 N61 . x - x - - - . ST073 N80 . x - x - - - . ST073			
			132 □ 150A	N100 . x - x - - - . ST073 N200 . x - x - - - . ST073			
			250A				
8 steps		30°	14 48 □ 20A	M10H . x - x - - - . ST083 M20 . x - x - - - . ST083			
			64 □ 32A	N20 . x - x - - - . ST083 N33F . x - x - - - . ST083			
			88 □ 63A	N40 . x - x - - - . ST083 N61 . x - x - - - . ST083 N80 . x - x - - - . ST083			
			132 □ 150A	N100 . x - x - - - . ST083 N200 . x - x - - - . ST083			
			250A				
9 steps		30°	15 48 □ 20A	M10H . x - x - - - . ST093 M20 . x - x - - - . ST093			
			64 □ 32A	N20 . x - x - - - . ST093 N33F . x - x - - - . ST093			
			88 □ 63A	N40 . x - x - - - . ST093 N61 . x - x - - - . ST093 N80 . x - x - - - . ST093			
			132 □ 150A	N100 . x - x - - - . ST093 N200 . x - x - - - . ST093			
			250A				
10 steps		30°	17 48 □ 20A	M10H . x - x - - - . ST0103 M20 . x - x - - - . ST0103			
			64 □ 32A	N20 . x - x - - - . ST0103 N33F . x - x - - - . ST0103			
			88 □ 63A	N40 . x - x - - - . ST0103 N61 . x - x - - - . ST0103 N80 . x - x - - - . ST0103			
			132 □ 150A	N100 . x - x - - - . ST0103 N200 . x - x - - - . ST0103			
			250A				
11 steps		30°	18 48 □ 20A	M10H . x - x - - - . ST0113 M20 . x - x - - - . ST0113			
			64 □ 32A	N20 . x - x - - - . ST0113 N33F . x - x - - - . ST0113			
			88 □ 63A	N40 . x - x - - - . ST0113 N61 . x - x - - - . ST0113 N80 . x - x - - - . ST0113			
			132 □ 150A	N100 . x - x - - - . ST0113 N200 . x - x - - - . ST0113			
			250A				

Ordering example: AC21 250A panel mounting, multi step switch 3-pole with off, 11 steps N200 E ST0113

Mini-Cam Switches M4H

Panel mounting E, IP40

Central fixing Z

Central fixing without escutcheon plate ZO

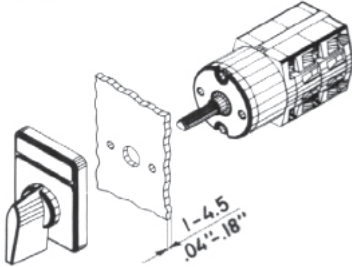

Mounting holes

D366-f

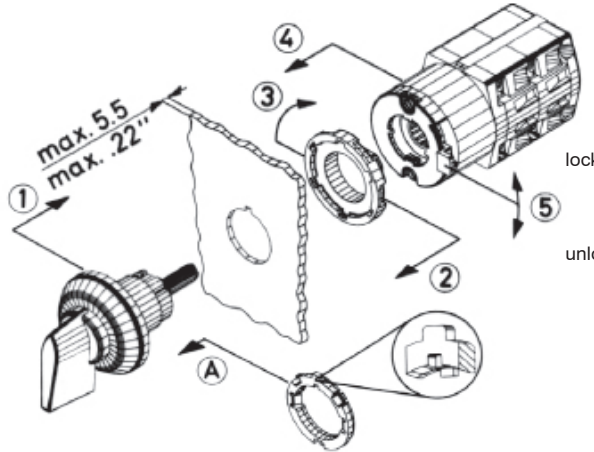
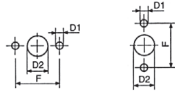

Central fixing 16mm

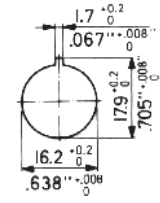

unlock Central fixing 22mm

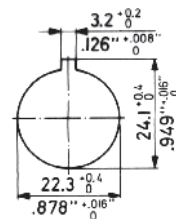

Single hole mountings are generally delivered for a 16mm (.64") mounting.

Using the forwarded adapter ring, it is possible to alter the single hole mountings from 22mm (.88"). For that purpose the adapter ring has to be attached onto the threaded part of the body in such a manner, that 1. the flat side of the adapter ring shows towards the front seal and 2. the inner nose fits into the notch of the body. The adapter ring has to be pushed towards the front seal.

Optional extras	ordering code	for design	M4H Z ... +SRE	M4H Z ... +SA.	M4H ZO ... +SA.	M4H Z ... +SRE+SA.
Additional escutcheon plate	+SRE	E, Z, ZO				
Additional escutcheon plate	+SRE2	E, Z, ZO				
Key operated switch with lock KABA	+SA1	Z, ZO				
with lock Ronis	+SA2	Z, ZO				

Wrench J7400
for switches M4H with central fixing is necessary

Panel mounting E

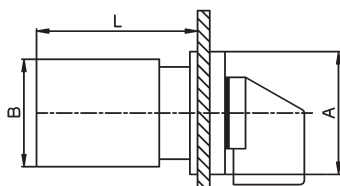

Central fixing Z, ZO

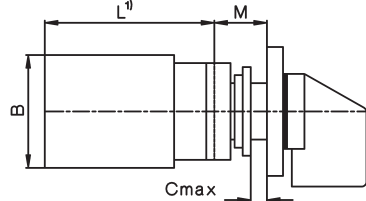

ZO

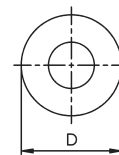

Z

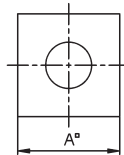

Type	A	B	D	M	Dimension L for ... cells								
					1	2	3	4	5	6	7	8	
M4H	mm	30	28	29,5	12,5	38,5	50,5	62,5	74,5	86,5	98,5	110,5	122,5

Technical data

Type	according to specifications	AC21A		AC15		Motor rating AC3							
		General use	10A/500V 10A/300V	2,5A 1,5A A300	380V 440V	3 phase 3-pole			1 phase 2-pole				
M4H	IEC, VDE, BS, SEV UL, CSA				Volt	110	220	380	110	220	380		
					kW	0,65	1,5	2,2	0,3	0,55	-	0,75	
					HP	0,75	1	-	0,33	0,75	0,75	-	

Type	according to specifications	Motor rating AC23 3-pole			2-pole			
		Volt	110	220	380	110	220	380
M4H	IEC, VDE, BS, SEV UL, CSA	kW	0,75	1,8	3	0,37	0,75	1,1
		HP	-	-	-	-	-	-

additional data for wiring according to UL and CSA

Type	type of wire	temp. rating of wire	torque value for field wiring terminals
M4H	copper wire only	60/75°C	0,6Nm / 5lb - inch

Mini-Cam Switches M4H

Switch programs

Description	Wiring diagram	AC21 500V 10A AC15 230V 2,5A AC3 4x400V 2,2kW	escutch. 30 x 30	numb. of cells	Type	Design			Switch pro- gram
						E. ↓	Z. ↓	ZO. ↓	
On-Off-switch A									
1-pole				1	M4H .	x	x	x	. A1
2-pole				1	M4H .	x	x	x	. A2
3-pole				2	M4H .	x	x	x	. A3
4-pole				2	M4H .	x	x	x	. A4
6-pole				3	M4H .	x	x	x	. A6
Changeover switch U									
1-pole				1	M4H .	x	x	x	. U1
2-pole				2	M4H .	x	x	x	. U2
3-pole				3	M4H .	x	x	x	. U3
4-pole				4	M4H .	x	x	x	. U4
Changeover switch without off W									
1-pole				1	M4H .	x	x	x	. W1
2-pole				2	M4H .	x	x	x	. W2
3-pole				3	M4H .	x	x	x	. W3
4-pole				4	M4H .	x	x	x	. W4
6-pole				6	M4H .	x	x	x	. W6
Reversing switch WU									
2-pole				2	M4H .	x	x	x	. WU2
3-pole				3	M4H .	x	x	x	. WU3
3-pole with spring return to 0				3	M4H .	x	x	x	. WU3R2
Star-delta switch SD									
1 rotary direction				4	M4H .	x	x	x	. SD
both rotary directions				5	M4H .	x	x	x	. SDR
Changeover with spring return UR									
1-pole				1	M4H .	x	x	x	. UR1
2-pole				2	M4H .	x	x	x	. UR2
3-pole				3	M4H .	x	x	x	. UR3
Start switch									
1-pole				1	M4H .	x	x	x	. SE
Stop switch									
1-pole				1	M4H .	x	x	x	. SA

Ordering example: Stop switch, 1-pole, Central fixing: **M4H Z SA**

Mini-Cam Switches M4H

Switch programs

Description	Wiring diagram	AC21 500V 10A AC15 230V 2,5A AC3 4x400V 2,2kW	escutch. 30 x 30	numb. of cells	Type	Design			Switch program
						.E. ↓	.Z. ↓	.ZO. ↓	
Start-Stop switch				1	M4H	x	x	x	. SEA
Start-Stop switch position START with spring return to 1				1	M4H	x	x	x	. S392
Start-Stop switch for reversing contactors				2	M4H	x	x	x	. S2EA
Voltmeter selector switch V 3 line voltages				2	M4H	x	x	x	. V3
3 phase voltages				2	M4H	x	x	x	. V0
3 line voltages 3 phase voltages				3	M4H	x	x	x	. V1
Ammeter selector switch A 1-pole, 3 current transformer				4	M4H	x	x	x	. M31
Gang switch GR 2 circuits A and B 1-pole 0 - A - A+B				1	M4H	x	x	x	. GR11
2 circuits A and B 1-pole 0 - A - B - A+B				1	M4H	x	x	x	. GR12
3 circuits A, B and C 1-pole				2	M4H	x	x	x	. GR14
Multi step switch without 0 ST 3 steps, 1-pole				2	M4H	x	x	x	. ST31
3 steps, 2-pole				3	M4H	x	x	x	. ST32
3 steps, 3-pole				5	M4H	x	x	x	. ST33

Ordering example: Multi step switch without 0, 3 steps, 3-pole, panel mounting: **M4H E ST33**



Mini-Cam Switches M4H

Switch programs

Description	Wiring diagram	AC21 500V 10A AC15 230V 2,5A AC3 4x400V 2,2kW	escutch. 30 x 30	numb. of cells	Type	Design			Switch pro- gram
						.E. ↓	.Z. ↓	.ZO. ↓	
Multi step switch without 0 ST									
4 steps, 1-pole				2	M4H .	x	x	x	.ST41
4 steps, 2-pole				4	M4H .	x	x	x	.ST42
4 steps, 3-pole				6	M4H .	x	x	x	.ST43
5 steps, 1-pole				3	M4H .	x	x	x	.ST51
5 steps, 2-pole				5	M4H .	x	x	x	.ST52
6 steps, 1-pole				3	M4H .	x	x	x	.ST61
6 steps, 2-pole				6	M4H .	x	x	x	.ST62
Multi step switch with 0 ST0.									
2 steps, 1-pole				1	M4H .	x	x	x	.ST021
2 steps, 2-pole				2	M4H .	x	x	x	.ST022
2 steps, 3-pole				3	M4H .	x	x	x	.ST023
3 steps, 1-pole				2	M4H .	x	x	x	.ST031
3 steps, 2-pole				3	M4H .	x	x	x	.ST032
3 steps, 3-pole				5	M4H .	x	x	x	.ST033
4 steps, 1-pole				2	M4H .	x	x	x	.ST041
4 steps, 2-pole				4	M4H .	x	x	x	.ST042
4 steps, 3-pole				6	M4H .	x	x	x	.ST043
5 steps, 1-pole				3	M4H .	x	x	x	.ST051
5 steps, 2-pole				5	M4H .	x	x	x	.ST052
6 steps, 1-pole				4	M4H .	x	x	x	.ST061
7 steps, 1-pole				4	M4H .	x	x	x	.ST071
8 steps, 1-pole				5	M4H .	x	x	x	.ST081
9 steps, 1-pole				5	M4H .	x	x	x	.ST091
10 steps, 1-pole				6	M4H .	x	x	x	.ST0101

Ordering example: Multi step switch with 0, 10 steps, 1-pole, Central fixing without escutcheon plate: **M4H ZO ST0101**

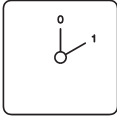
Load Switches for resistive or slightly inductive loads or switching without load

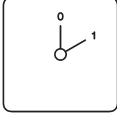
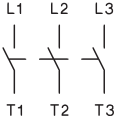
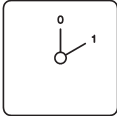
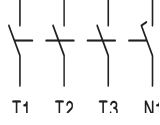
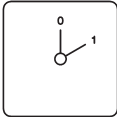
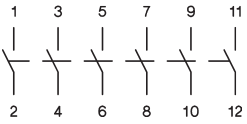
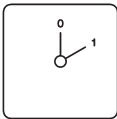
Description	Wiring diagram	Switching angle	Number of cells ↓ Size ↓ AC21	Type	Design		Switch program	Escutcheon plate
					.E.	.V.		
On-Off-switches A								
1-pole		60°	2 88 □ 125A	L100	x	x	. A1	
			1 180A					
			1 132 □ 400A	L400	x	x	. A1	
			3 600A	L600	x	x	. A1	
			2 800A	L800	x	x	. A1	
3 1200A	L1200	x	x	. A1				
2-pole		60°	2 88 □ 125A	L100	x	x	. A2	
			2 180A					
			2 132 □ 400A	L400	x	x	. A2	
			3 600A	L600	x	x	. A2	
			4 800A	L800	x	x	. A2	
			6 1200A	L1200	x	x	. A2	
3-pole		60°	4 88 □ 125A	L100	x	x	. A3	
			3 180A					
			3 132 □ 400A	L400	x	x	. A3	
			6 600A	L600	x	x	. A3	
			6 800A	L800	x	x	. A3	
			9 1200A	L1200	x	x	. A3	
4-pole 4. pole early make		60°	4 88 □ 125A	L100	x	x	. A4	
			4 180A					
			4 132 □ 400A	L400	x	x	. A4	
			6 600A	L600	x	x	. A4	
			8 800A	L800	x	x	. A4	
12 1200A	L1200	x	x	. A4				
6-pole		60°	6 88 □ 125A	L100	x	x	. A6	
			6 180A					
			6 132 □ 400A	L400	x	x	. A6	
			9 600A	L600	x	x	. A6	
			12 800A	L800	x	x	. A6	
			18 1200A	L1200	x	x	. A6	

For switches with the design **V.** it is necessary to state the installation depth - that is, the distance between mounting level of the switch and the inside edge of the door (dimension T).

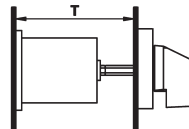

Further informations page
 Technical Data 261
 Dimensions 266

Load Switches for resistive or slightly inductive loads or switching without load

Description	Wiring diagram	Switching angle	Number of cells ↓ Size ↓ AC21	Type	Design		Switch program	Escutcheon plate
					.E.	.V.		
Changeover switches U								
1-pole		60°	2 88 □ 125A	L100 .	x	x	. U1	
			2 180A	L160 .	x	x	. U1	
			2 132 □ 400A	L400 .	x	x	. U1	
			3 600A	L600 .	x	x	. U1	
			4 800A	L800 .	x	x	. U1	
6 1200A	L1200 .	x	x	. U1				
2-pole		60°	4 88 □ 125A	L100 .	x	x	. U2	
			4 180A	L160 .	x	x	. U2	
			4 132 □ 400A	L400 .	x	x	. U2	
			6 600A	L600 .	x	x	. U2	
			8 800A	L800 .	x	x	. U2	
12 1200A	L1200 .	x	x	. U2				
3-pole		60°	6 88 □ 125A	L100 .	x	x	. U3	
			6 180A	L160 .	x	x	. U3	
			6 132 □ 400A	L400 .	x	x	. U3	
			9 600A	L600 .	x	x	. U3	
			12 800A	L800 .	x	x	. U3	
18 1200A	L1200 .	x	x	. U3				
4-pole 4. pole early make		60°	8 88 □ 125A	L100 .	x	x	. U4	
			8 180A	L160 .	x	x	. U4	
			8 132 □ 400A	L400 .	x	x	. U4	
			12 600A	L600 .	x	x	. U4	
			16 800A	L800 .	x	x	. U4	
24 1200A	L1200 .	x	x	. U4				
Changeover switches without off W								
1-pole		60°	2 88 □ 125A	L100 .	x	x	. W1	
			2 180A	L160 .	x	x	. W1	
			2 132 □ 400A	L400 .	x	x	. W1	
			3 600A	L600 .	x	x	. W1	
			4 800A	L800 .	x	x	. W1	
6 1200A	L1200 .	x	x	. W1				
2-pole		60°	4 88 □ 125A	L100 .	x	x	. W2	
			4 180A	L160 .	x	x	. W2	
			4 132 □ 400A	L400 .	x	x	. W2	
			6 600A	L600 .	x	x	. W2	
			8 800A	L800 .	x	x	. W2	
12 1200A	L1200 .	x	x	. W2				
3-pole		60°	6 88 □ 125A	L100 .	x	x	. W3	
			6 180A	L160 .	x	x	. W3	
			6 132 □ 400A	L400 .	x	x	. W3	
			9 600A	L600 .	x	x	. W3	
			12 800A	L800 .	x	x	. W3	
18 1200A	L1200 .	x	x	. W3				
4-pole 4. pole early make		60°	8 88 □ 125A	L100 .	x	x	. W4	
			8 180A	L160 .	x	x	. W4	
			8 132 □ 400A	L400 .	x	x	. W4	
			12 600A	L600 .	x	x	. W4	
			16 800A	L800 .	x	x	. W4	
24 1200A	L1200 .	x	x	. W4				

Ordering example: AC1 1200A panel mounting, changeover switch without off 4-pole L1200 E W4

Operating Knobs and Handles

Types of handles

In the standard version, the switches are supplied with a black twist knob or instrument knob (M10H - N33F), except for design SMA, which has a grey toggle knob. Switches of size L, which consist of 2 or 3 switch columns, come with a black hand wheel. If required, the switch can be supplied with other knobs, which can later easily be exchanged. All operating knobs have an insert, which sets the position of the knob in relation to the switch shaft. This insert can be mounted in 8 different positions (at intervals of 45°), causing the angle of each individual switch setting to be rotated by 45°.

In the standard version, the switch terminals are positioned left and right (except M10H). When the knob insert is turned by 90°, the lay-out of the terminals changes to top and bottom.

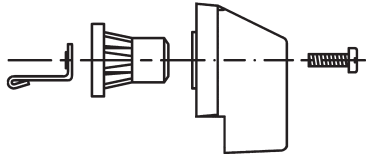

All operating knobs can be moved on the hexagonal shaft, to permit adaptation to different sheet thicknesses, etc.

Type	M10 M10H M20	N20 N33F	N40 N61 N80 L100 L160	N100 N200 L400 L600 L800 L1200
Knob movement mm	5	5	7	9
Hexagonal shaft dimension mm	5	7	9	12

Ordering example: Cam switch N61 V U3 with Instrument knob red
Order type: **N61 V U3 +G3**
Dimensions see page 267

Knobs and handles Description	Colour	Ordering Code	M10 M10H M20	N20 N33F	N40 N61 N80 L100 L160	N100 N200 L400 L600 L800 L1200
Instrument knob Standard for M10 to N200	grey	+G1	X	X		
	black	+G2	X	X	X	X
	red	+G3	X	X		
	white	+G5	X	X		
Toggle knob	grey	+K1	X	X		
	black	+K2	X	X		
	red	+K3	X	X		
	white	+K5	X	X		
	blue	+K6	X			
Hand wheel	black	+HR				X



Escutcheon Plates

TELUX-Cam Switches in designs E, V, P, PF, SM, UP, Z and KE are supplied with a square escutcheon plate consisting of a black frame and plexi insert plate. The markings are printed in black on the back of the insert plate. To protect the markings so that they remain easy to read, the back of the insert plate is lined with silver foil. In addition, rectangular plates can be provided for all switch sizes, which can be fitted on all switches after mounting.

Square plate



Rectangular plate
(with square plate)
Slot on the cover plate
upper side

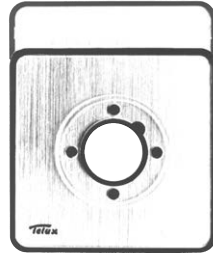

Preferred position of the slot
on bottom of
the cover plate

Slot for additional plate

TELUX-Cam Switches in design SMA, for distribution boards with 45mm inside edge of installation cover, is supplied with a grey cover and black markings.



Special engraved markings on escutcheon plates are limited by the available space. In the case of relatively large production runs or frequent use of the text, we recommend ordering of a printing block. This will be invoiced at cost price, and the engraving will not be charged for. This investment generally pays with batches from 50 pieces upwards.

The "escutcheon plate" column of the selection and ordering tables for switch programs indicates the standard plate and, in some cases, an additional plate that is often used for the programs in question. If such a plate, listed in the selection table, is desired, the appropriate code number should be stated when ordering a switch and switch program.

Should only **plates** or **parts** of the latter be ordered, the order type is assembled as shown by the following example.

Code letter of switch sizes

M10, M10H, M20	A
N20, N33F	E
N40, N61, N80, L100, L160	H
N100, N200, L400, L600, L800, L1200	L

Ordering example: Escutcheon plate silver, complete, for cam switch M10, marked with MAN OFF AUTO, angle of rotation 60°

Order type:

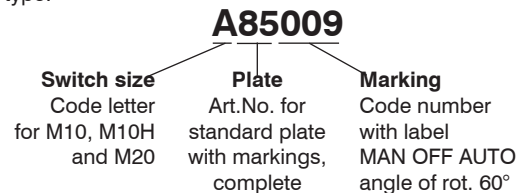

However, if a **switch** with non-standard lettering is required, only three-digit code number for the marking need be added to the order type (see next page).

Dimensions see page 267

Description	Order type Switch size Code letter	Plate Art.No.	Marking Code number
Escutcheon plate for designs E, V, P, Z, SM, KE and UP Escutcheon frame black, plexi insert plate silver, markings black			
Plexi insert plate silver	A E H L	.85...	... (see pp. 244-248)
Plexi insert plate yellow	A E H L	.80...	... (see pp. 244-248)
Escutcheon frame black	A E H L	.8203	-
Rectangular escutcheon plate for designs E, V, Z and SM Escutcheon frame black, plexi insert plate silver, markings black			
Plexi insert plate silver	A E H L	.885..	... (see pp. 244-248)
Plexi insert plate yellow	A E H L	.895..	... (see pp. 244-248)
Escutcheon frame black	A E H L	.8503	-
Installation cover for design SMA grey cover, markings black	A - - -	.68...	... (see page 246)

Escutcheon Plates

Selected standard markings

The markings that are most commonly required are shown below, together with code letters for the switch size and the code number.

Ordering example: Switch type M10H E A3 with escutcheon plate "OFF ON" and additional rectangular escutcheon plate "PUMP"

Order type: **M10H E A3 +003 +516**

Code letter of switch sizes

M10, M10H, M20
N20, N33F
N40, N61, N80, L100, L160
N100, N200, L400, L600, L800, L1200

A
E
H
L

Blank escutcheon plates

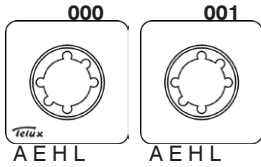

Switching angle 30°

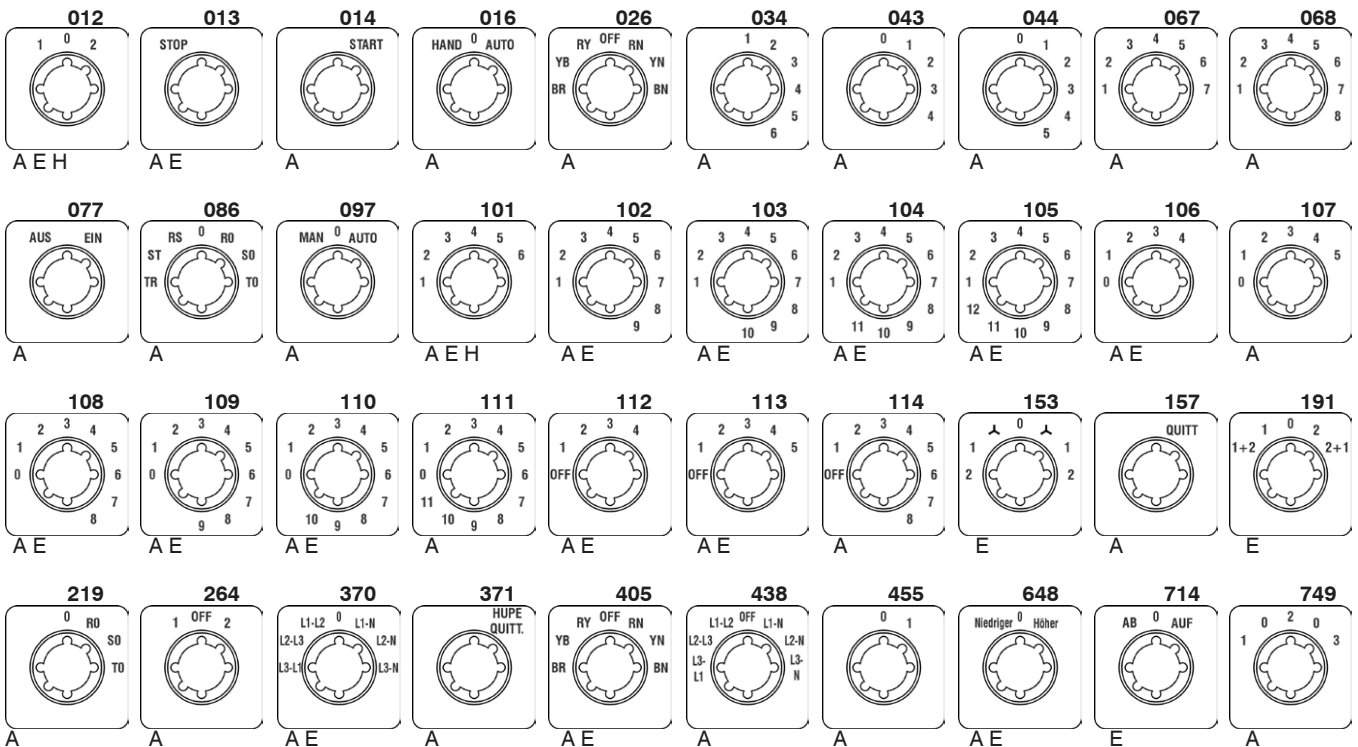

Switching angle 45°

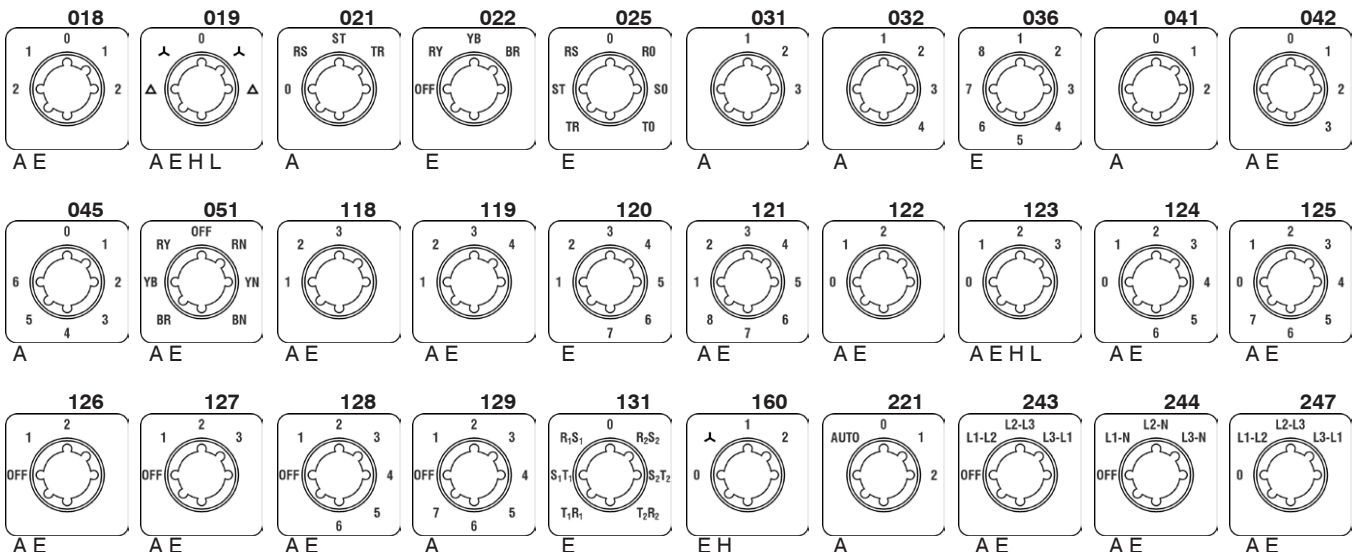

Escutcheon Plates

Switching angle 45°

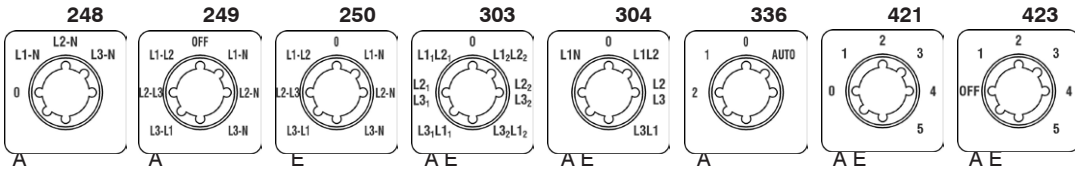

Switching angle 60°

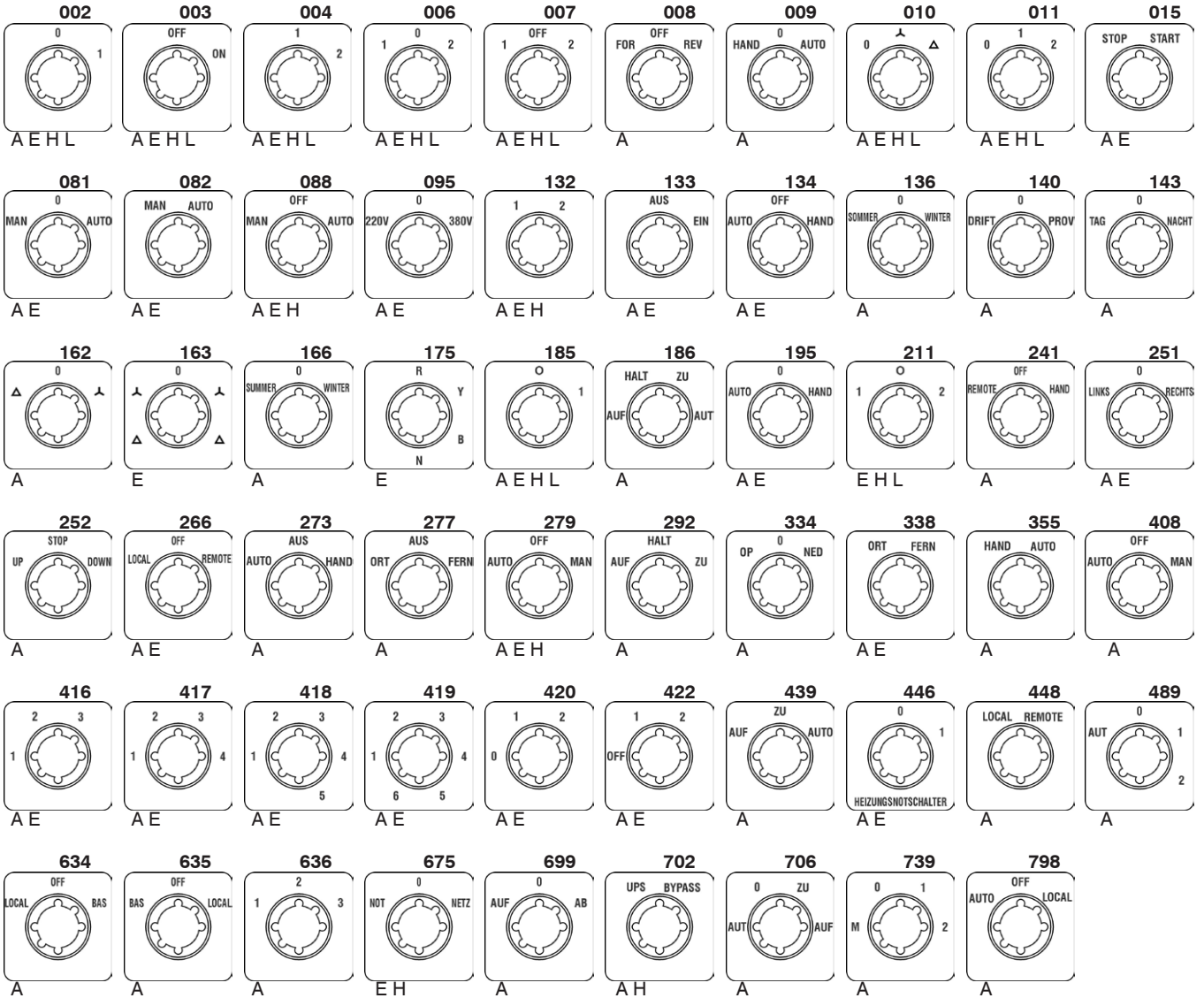

Escutcheon Plates

Switching angle 90°

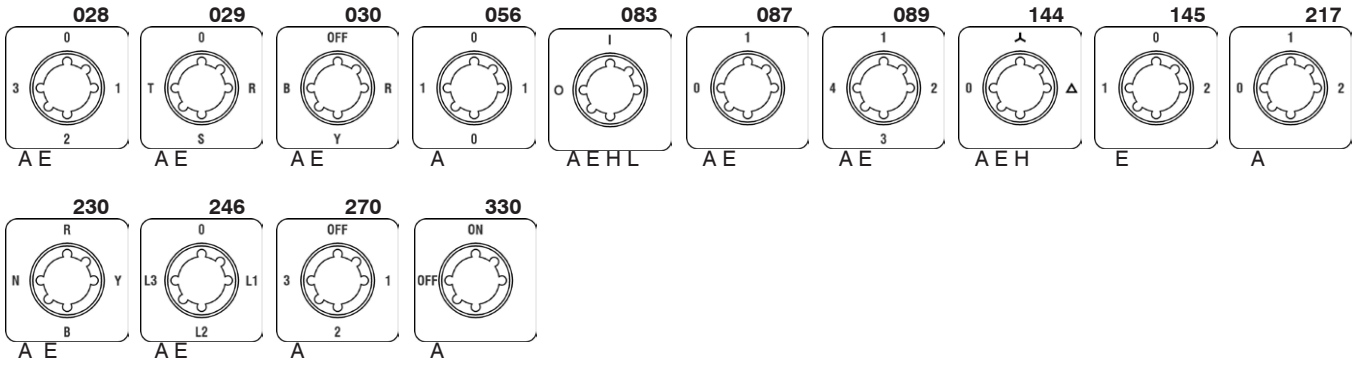

Miscellaneous

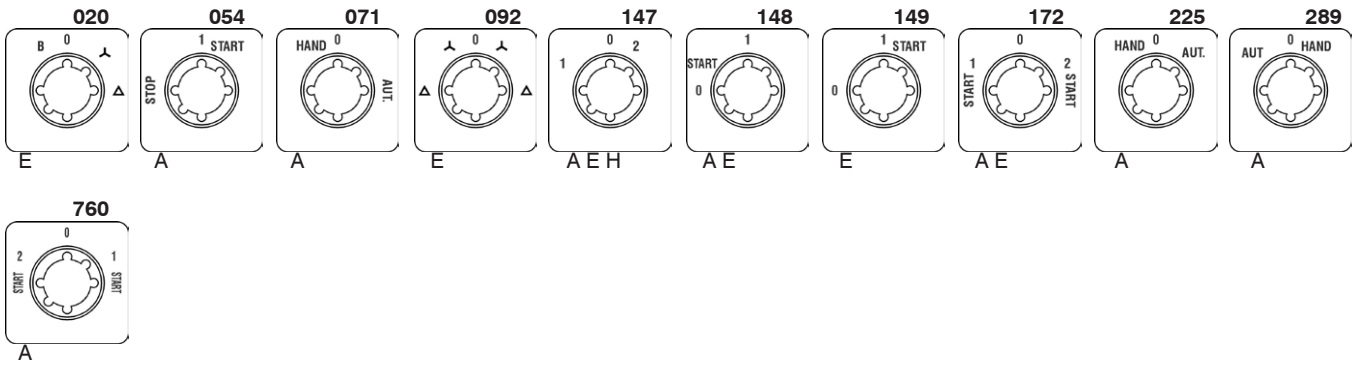

Rectangular additional escutcheon plates

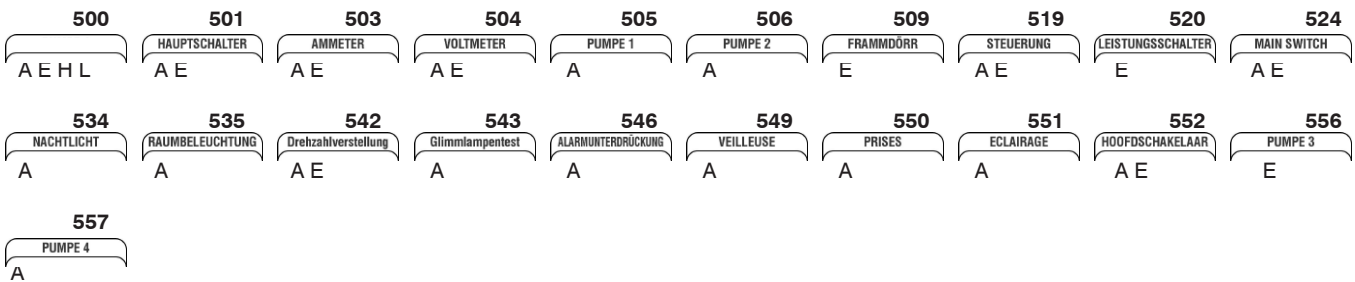

Covers for design SMA

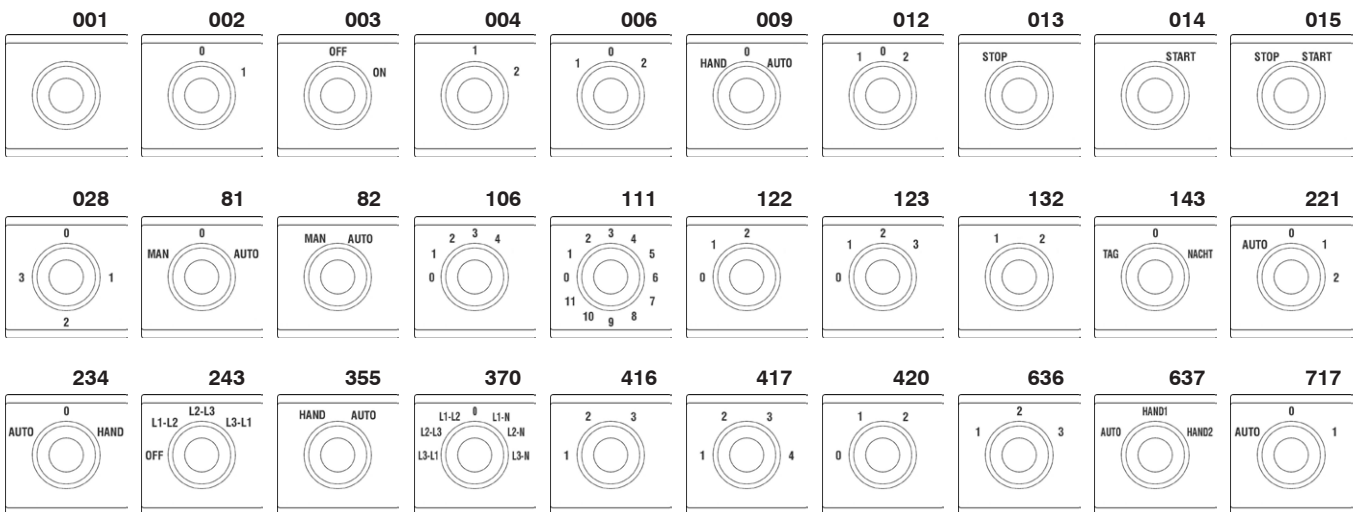

Switching angles

Arrangement of switch settings

All feasible arrangements of switch settings are shown, and defined by position numbers, in the following tables. Not only the switching angles, but also switches with latched or momentary settings, or combinations of the two, are distinguished from one another.

Knowledge of the following variations is particularly important when planning special switches. It is necessary to state the position number when ordering special switches, as the cheapest version will otherwise be selected.

All the switches types listed can be supplied with switching angles other than those indicated, provided that they are permitted by the switch program (additional charge).

Switching angle 30°

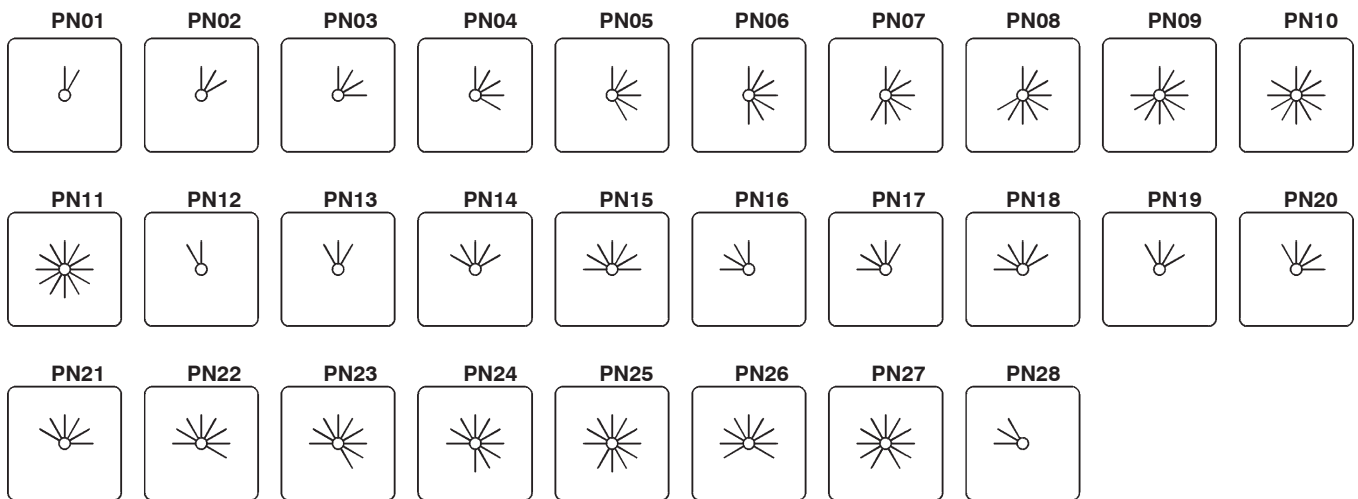

Switching angle 45°

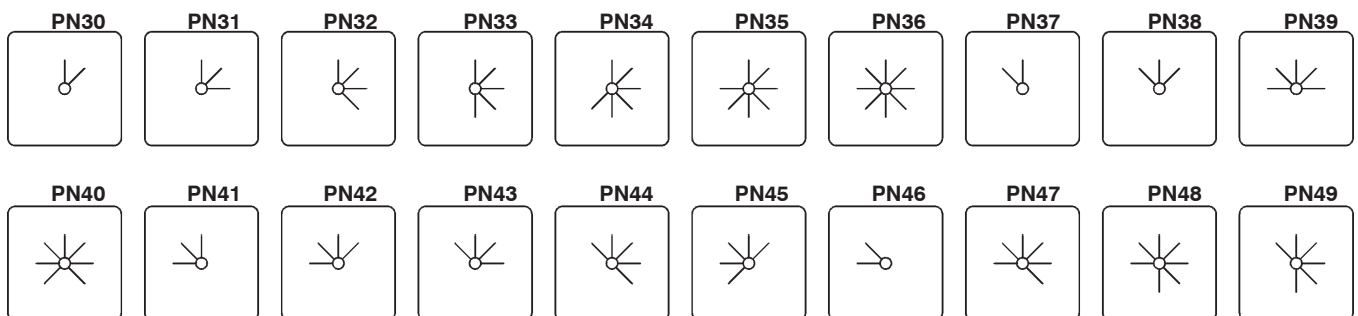

Switching angle 60°

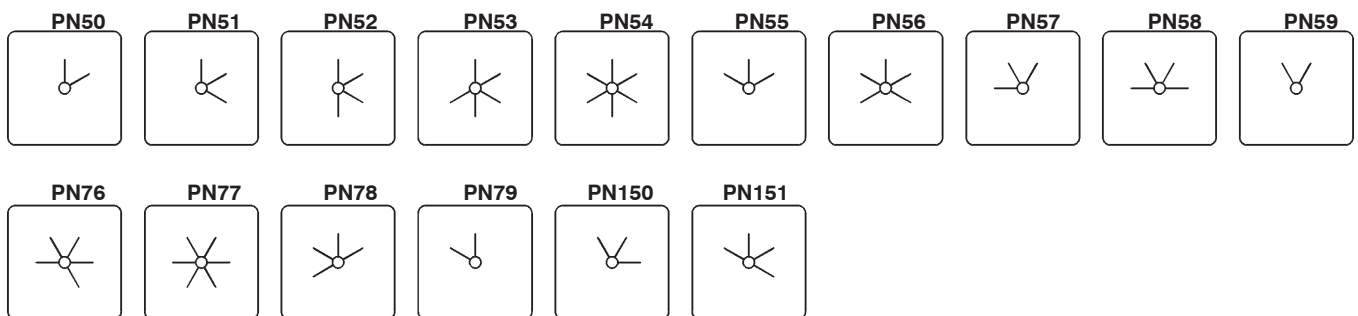

Switching angle 45/90°

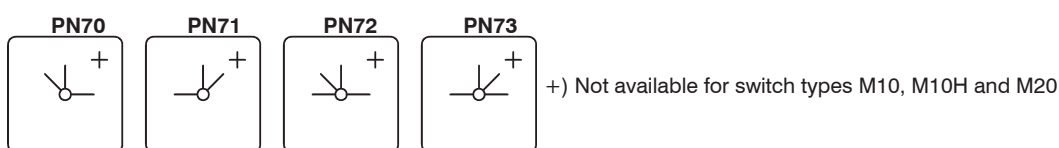

Switching angles

Switching angle 90°

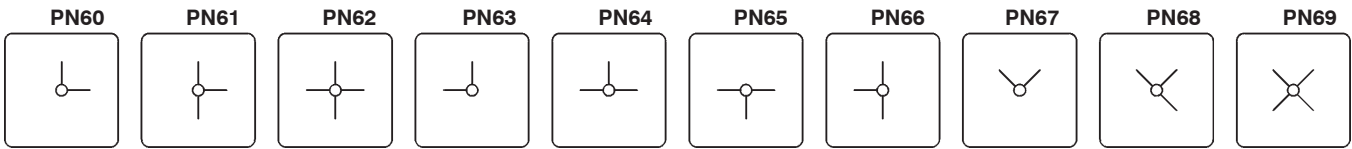

Momentary settings and special combinations

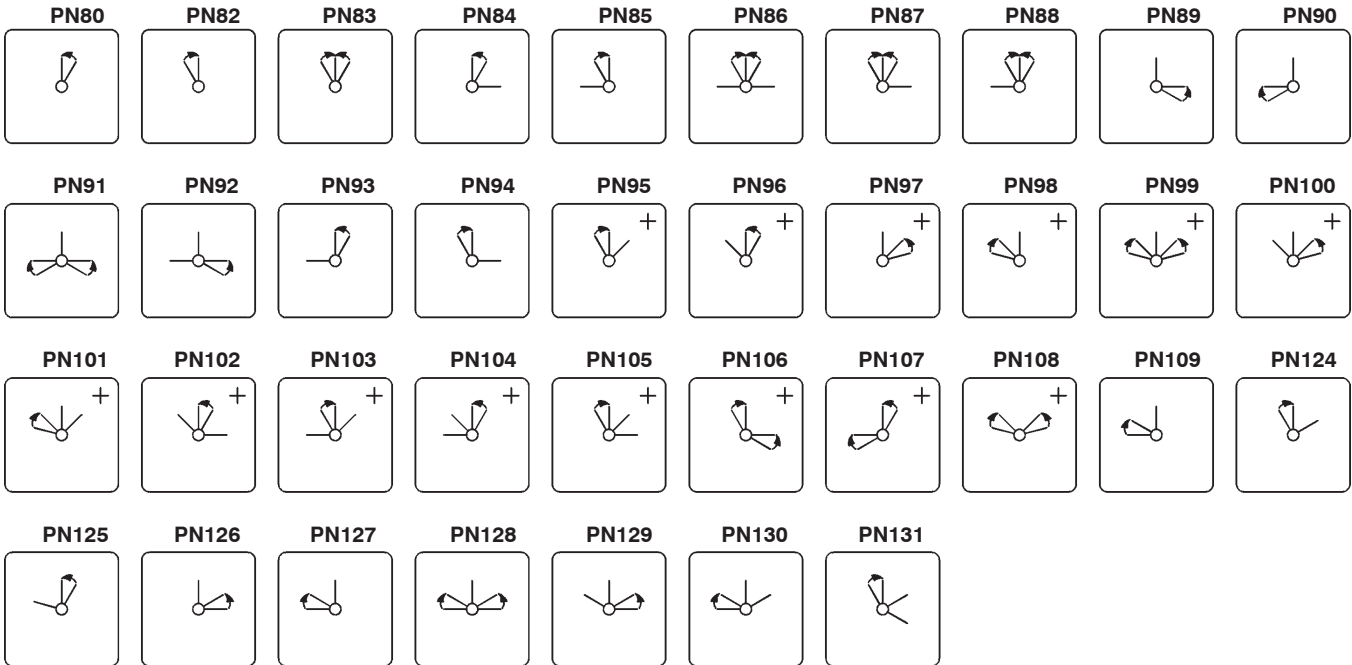

Spring return over several settings

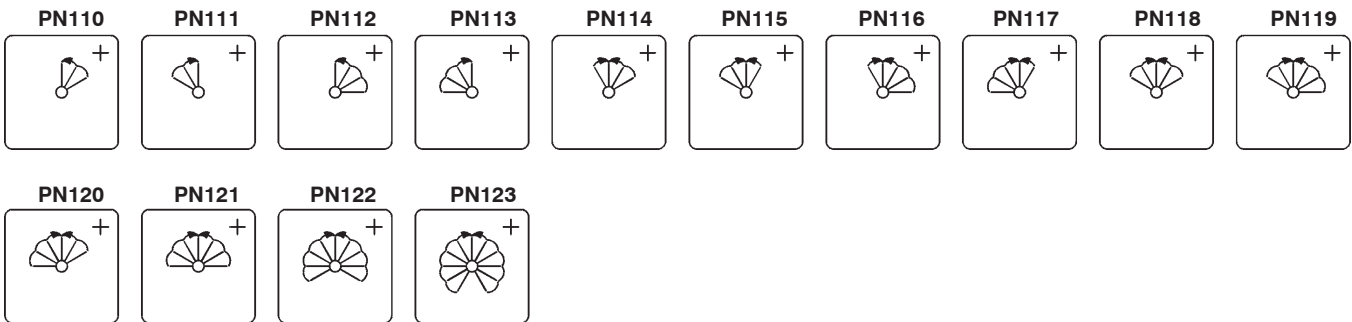

+) Not available for switch types M10, M10H and M20

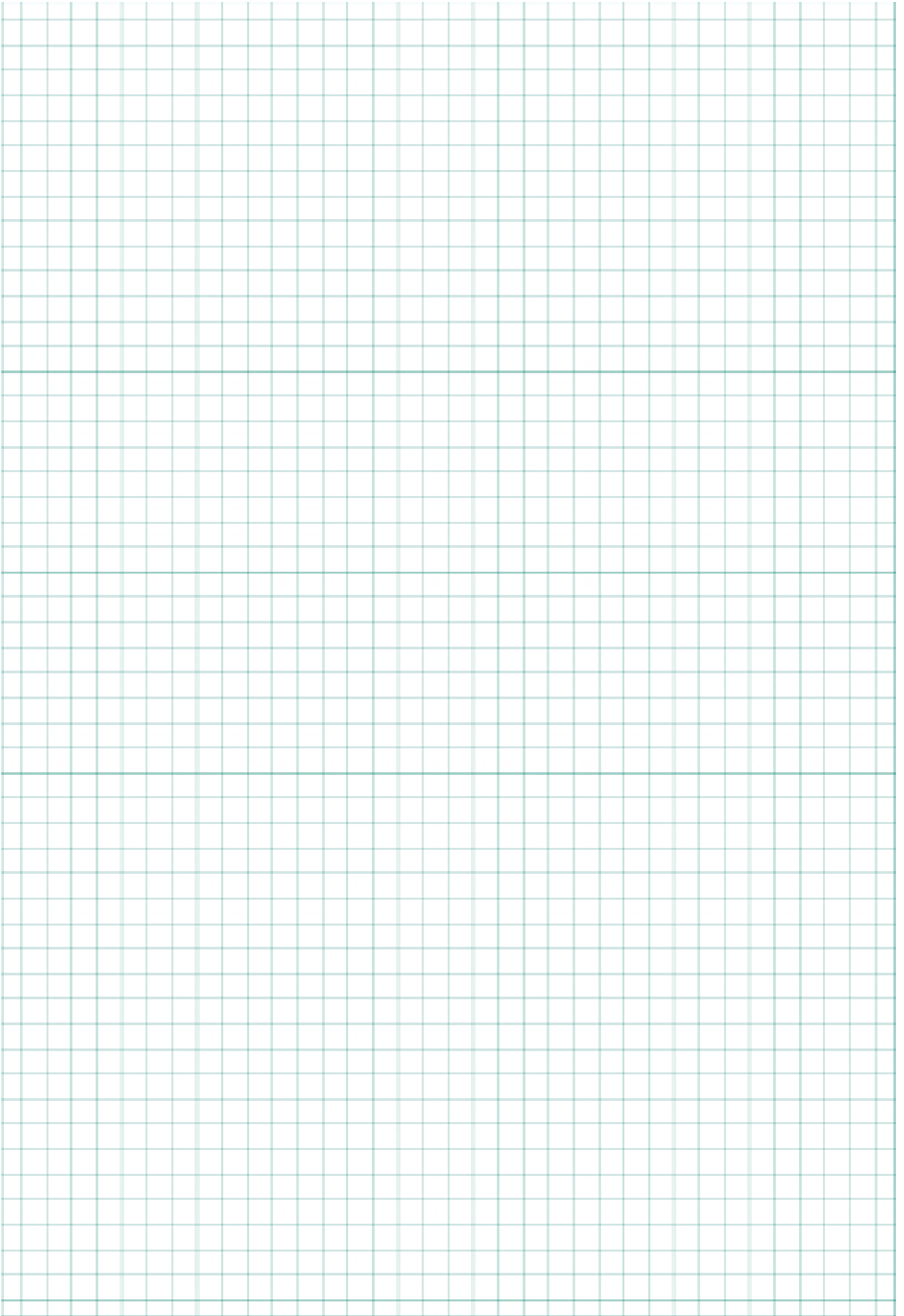

Door couplings

For switches with door couplings it is necessary to state the installation depth - that is, the distance between mounting level of the switch and the inside edge of the door (dimension T).

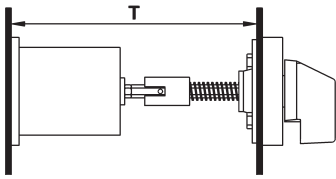

Door couplings are available for switches to be installed in switchgear cabinets or distribution boards with hinged doors. These permit the doors to be opened without removal of the operating knobs.

Ordering example: Cam switch N100 V A3 with lockable door coupling, moisture protected IP65, dimension T=580mm
Order type: **N100 V A3 +TK2FR/580**

Dimensions see page 269



	Ordering Code	Suitable for designs	Suitable for switch type
Door coupling Protection class from front: IP65 5-hole mounting	+TKE/...	V, SM	M10H, M20, N20, N33F
Door coupling locked Protection class from front: IP65 5-hole mounting Doors only open at a given switch setting: unless otherwise stated, the "OFF" setting.	+TK2E/...	V, SM	M10H, M20, N20, N33F
Door coupling locked Protection class from front: IP65 Central fixing Ø22mm Doors only open at a given switch setting: unless otherwise stated, the "OFF" setting.	+TK2Z/...	V, SM	M10H, M20, N20, N33F
Door coupling Protection class from front: IP40 5-hole mounting	+TK/...	V	N40, N61, N80, N100, N200 L100, L160, L400, L600 L800
Door coupling Protection class from front: IP54 5-hole mounting	+TKFR/...	V	N40, N60, N80, N100, N200 L100, L160, L400, L600 L800
Door coupling locked Protection class from front: IP40 5-hole mounting Doors only open at a given switch setting: unless otherwise stated, the "OFF" setting.	+TK2/...	V	N40, N61, N80, N100, N200 L100, L160, L400, L600 L800
Door coupling locked Protection class from front: IP54 5-hole mounting Doors only open at a given switch setting: unless otherwise stated, the "OFF" setting.	+TK2FR/...	V	N40, N61, N80, N100, N200 L100, L160, L400, L600 L800

Lockable switches

Key-operated and lockable switches are supplied with two keys. Additional keys or other types of lock on request.

Ordering example: Cam switch N20 E A3 key operated
Order type: **N20 E A3 + SA**

Dimensions see page 270 and 271



Key operated switch
Lock Willenthal FT101, key removable in all lockable settings.
Other types of lock on request.
Maximum number of cells
M10 - N33F: 6 N40, N61: 2
Key operated switch, key removable only in some settings. Add letter of setting where key is removable to ordering code according to the scetch below.

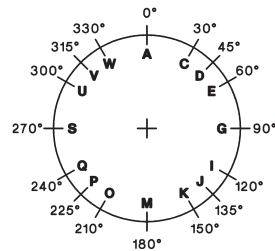

Key operated switch IP65
Lock Ronis R455, key removable in all lockable settings.
Key operated switch, key removable only in some settings. Add letter of setting where key is removable to ordering code according to the scetch above.

Key operated switch
Lock KABA8, key removable in all lockable settings.
Key operated switch, key removable only in some settings. Add letter of setting where key is removable to ordering code according the scetch below.

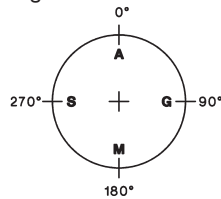

Key operated switch with barrel for special security functions
Lock EVVA EHZ50/5 Nickel matt
Special version which prevents not only switching but also access to the cable ends and removal of the switch when locked.
Maximum number of cells
Design E, P: 4
Design UP: 3

Key operated switch for special security functions without lock
for use of lock EVVA EHZ50/5 or with same dimensions
Maximum number of cells
Design E, P: 4
Design UP: 3





Ordering Code	Suitable for designs	Suitable for switch type
+SA +SA/.	E, V, SM E, V P SMA UP	M10H, M20, N20, N33F N40, N61 M10, N20, N33F, N40, N60 M10H, M20 M10
+SA +SA/.	Z, ZO	M10H, M20
+SAK +SAK/.	E	M10H, M20
+SASI	E P UP	M10H, M20 M10, M20 M10, M20
+SASO	E P UP	M10H, M20 M10, M20 M10, M20

Padlock devices

A range of padlock devices designed to prevent from being turned on by unauthorized personnel, or during maintenance and repair work, can be supplied.

Dimensions see page 272

Ordering example: Cam switch N33F E A3 with interlocking device SV3 suitable for 3 padlocks
Order type: **N33F E A3 +SV3**

Padlock device Description	Ordering Code	Suitable for designs	Suitable for switch type
 <p>Padlock device Standard version black, otherwise red, for 1 or 2 padlocks. Shackles up to Ø6mm Standard version black 64 x 64mm, otherwise red 64 x 64mm</p>	<p>+SV1 +SV1R</p> <p>+SV164 +SV164R</p>	<p>E, V, SM P, PF</p> <p>E, V P, PF</p>	<p>M10H, M20 M10</p> <p>M10H, N20, N33F N20, N33F</p>
 <p>Padlock device Standard version black, otherwise yellow insert plate and red twist knob for 1-3 padlocks. Shackles up to Ø8,5mm Prior to insertion of the first padlock, a red locking ledge must be depressed. This indicates that the switch is locked.</p>	<p>+SV3 +SV3R E, V</p>	<p>E, V E, V L800, L1200 PF</p>	<p>N40, N61, N80, L100, L160 N100, N200, L400, L600, N40, N61, N80, N100, N200</p>
 <p>Padlock device Standard base grey, locking ring black, or with yellow base and red locking ring. Locking ring for 1-3 padlocks. Shackles up to Ø6mm Standard base grey, locking ring black 88 x 88mm, or with yellow base and red locking ring 88 x 88mm</p>	<p>+SV4 +SV4R</p> <p>+SV488 +SV488R</p>	<p>E, V SM P, PF</p> <p>E, V E, V P, PF</p>	<p>M10H, N20, N33F M10H, N20, N33F N20, N33F</p> <p>N20, N33F N40, N61, N80 N40, N61, N80</p>
 <p>Key lock device With a cylinder lock in the lock attachment, one or more switch settings are lockable (state when ordering). The operating knob can only be turned when unlocked. The key can be withdrawn wheter locked or unlocked. Special versions, in which the key cannot be withdrawn when in some (unlockable) settings can be supplied.</p>	<p>+SZ</p>	<p>E, V SM</p>	<p>alle M10H, M20, N20, N33F</p>
<p>Key lock device Special version for on-off switches, in which it is possible to switch off without a key.</p>	<p>+SZ2</p>	<p>E, V SM</p>	<p>alle M10H, M20, N20, N33F</p>

Switch interlocks

A wide range of locks and interlocking devices, designed to prevent accidental or hazardous switching, can be supplied.

Ordering example: Cam switch N20 E A3 with push button switch lock
Order type: **N20 E A3 + DV**

Dimensions see page 273

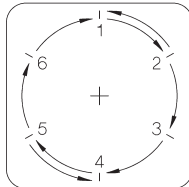
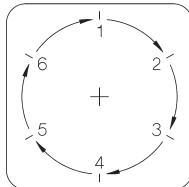
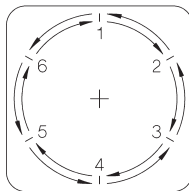

Description	Ordering Code	Suitable for designs	Suitable for switch type
Push button interlock The switch can only be actuated when the pushbutton is simultaneously depressed (two-handed operation).	+DV	E, V	all
Interlock with electrical contact The switch can only be actuated when the pushbutton, which also operates a make and break contact, is actuated (for external interlocking devices or safety measures).	+ET	E, V	all
Magnetic interlock The switch can only be actuated when an electromagnet is simultaneously excited. When ordering, voltage and percentage duty cycle of the magnet coil should be stated.	+MV	E	N20, N33F, N40, N61, N80 N100, N200
Circular switch Switches that have the maximum number of settings for a given switching angle can be made without a stop position, permitting direct switching from the last to the first setting.	+RU	all	all
Backswitch 1 Special version of the circular switch, in which the switch can only be turned in one direction.	+RS1	all	all
Backswitch 2 Special version of the circular switch, in which, in given positions, the switch can only be operated in one direction.	+RS2	all	all

Couplings and stop mechanism

A range of couplings and stop mechanisms for trouble-free operation of switches with a very large number of contacts can be supplied.

Dimension see page 274

Ordering example: Cam switch N200 V ST0113 spread over three columns interconnected by gears

Order type: **N200 V ST0113 +ZK3**



Description	Ordering Code	Suitable for designs	Suitable for switch type
<p>Coupling of two columns For simultaneous drive of two switch columns (with very large number of switch cells or limited installation depth).</p>	+ZK2	E, V	all
<p>Coupling of three columns For simultaneous drive of three switch columns.</p>	+ZK3	E, V	all
<p>Coupling of different switch sizes For attachment of control switches (auxiliary contacts) to larger switches. M10H, M20 in sizes E and H. N20 to N80 in size L.</p>	+ZWK	E L800, L1200	N40, N61, N80, L100, L160 N100, N200, L400, L600,
<p>Delayed action switch Using a delayed action coupling, two switch shafts - a main shaft and delayed shaft - can be coupled, such that the delayed shaft is rotated together with the main shaft once a given angle of rotation is reached (e.g. for off-load return of switches used with pole-changing motors).</p>	+SK	E, V G, GF	N20, N33F, N40, N61, N80 N20
<p>Second stop mechanism With switches in which a large number of contacts is simultaneously operated, use of a second stop mechanism is sometimes necessary, in order to ensure precise switching to the next setting.</p>	+RW2	all	all
<p>Metal stop mechanism for extreme mechanical stress on the stop mechanism, e.g. where many contacts are switched at the same time. Not for PN110 to PN123</p>	+MRW E, V	E, V E, V L800, L1200 G, GF	N40, N61, N80, L100, L160 N100, N200, L400, L600, N20

Special versions

A number of special versions can be supplied for adaptation of switches to various conditions of use.

Ordering example: Cam switch M10H E U3 with large front plate
Order type: **M10H E U3 +GFP**



Description	Ordering Code	Suitable for designs	Suitable for switch type
Switch shaft sealing For increased front protection class on IP54.	+WD	E, V SM	N20 to L1200 N20, N33F
Front plate/switch shaft sealing For increased front protection class on IP65. In this version, a wider hole is required for the shaft. Dimensions see page 272	+FPWD	E, V, SM	N20, N33F
Extended switch shaft For adaptation of switch designs V and SM to the enclosure depth. State additional shaft length when ordering.	+VW/...	E, V SM	all M10H, M20, N20, N33F
Large front plate Switch with front plate and operating knob of the next size (for replacement of older, larger switches or aesthetic reasons).	+GFP	E, V, SM	M10H, N20, N33F
Switch with pilot lamp lamp red, 230V lamp red, 400V lamp green, 230V lamp green, 400V	+SLR/230 +SLR/400 +SLG/230 +SLG/400	E P UP	all M10, N20, N33F, N40, N61 M10, N20
Gold plated contacts For electronic circuits with low voltages and currents.	+GK	all	M10H, M20, N20, N33F
Tropical proof type	+TR	all	all
Neon safety switch For all-pole switching off of neon advertisement circuits by the Fire Brigade. Dimensions see page 274	+FEU	E	N20, N33F





Accessories

A number of special versions can be supplied for adaptation of switches to various conditions of use.

Dimensions see page 273

Ordering example: Cam switch N20 E A3 with terminal cover plate
Order type: **N20 E A3 +KLAD**

Description	Ordering Code	Suitable for designs	Suitable for switch type
Terminal cover plate Prevents accidental touching of live terminals (requirement for main switches according to VDE 0113) only for 2 cells for all cells	+KLAD	E, V	N20, N40, N61, N80 N100, N200
	+KLAD	E, V	N33F
Moisture proofing caps Protection class from rear: IP54. For protection of the switch from dust and moisture (e.g. when installed in machine pedestals). For switch mounting from the front and rear. Conical cable entry glands. Maximum number of cells: M10H 7 N20 5 N40 4 N61 2	+FR	E	M10H, N20, N40, N61
 Angled terminals For easy connection of inaccessible switches. Unless otherwise stated, all terminals specified with markings are equipped in this manner. A distinction is drawn between left and right angled terminals. Seen from the switch end, the left terminals are located above left and below right; conversely, right terminals are above right and below left.	+WK	E, V N100	M20, N20, N40, N61, N80, N100
 Fast-on connectors For 6,3 x 0,8mm plugs.	+AMPZ	E, V	M20, N20
Earth terminals 2 terminals, connected with one another, insulated from switch column: for earth conductors.	+PE	E, V, P, PF PF G, GF	all M10, N20, N33F, N40, N61 N80, N100, N200 N20
Additional rectangular escutcheon plate 1 line Dimensions see page 267	SRE	E, Z, V, SM	all
Big additional rectangular escutcheon plate for 2 lines Dimensions see page 267	SRE2	E, V	M10H, M20, N20, N33F
Spare key for key operated switches with Lock Willenhal FT101	J7101	E, V, P SMA	M10H, M20, N20, N33F, N40 M10H, M20
Spare key for key operated switches with Lock Ronis R455	B4-R455	Z, ZO	M10H, M20
Wrench for switches with central fixing	J7049	Z, ZO	M10H, M20

Switching Programs according to Customer Requirements

As a result of their modular construction, TELUX cam switches are particularly suitable for manufacturing of special variants. According to its function, each pair of contacts in the switch is adapted to the desired program by appropriate design of the cam plate. In the case of switches with an overall switching angle of more than 180°, provision must be made for a cam plate in each switching cell, controlling two opposite, independent contact pairs with matching programs (does not apply to M10, M10H, M20 and N20).

Depending on the desired contact program for the special switch, it may often be impossible to make full use of all switching cells, that is, to include the maximum possible number of contacts. In determining the number of cells or switch length, one-contact cells will sometimes be resorted to.

Switch sizes M10, M10H, M20 and N20 are exceptions to this rule. Here, two cam plates can be built into each cell, so that both contacts are independently controlled (full use of the cells with special programs).

In all special switches with overall switching angles of less than 180°, the number of cells required is calculated by having the total number of contacts in the switching program.

When planning for switches with special programs, choice of the optimum switching angle thus plays an important part. The listing of all the options for lay-out of switch settings, on pages 247 and 248, should be an aid to planning (position numbers PN).

If special markings are to be engraved on the escutcheon plates, it is vital to take account of the available space. It is advisable to use abbreviations.

We provide forms (see page 275) on request, free of charge, to give a clear overview when special programs are being defined. Switch size, design, type of operating knob and desired switching angle, as well as the function of the contacts, are entered on these forms. Provision has also been made in them for entry of details as to escutcheon plate engravings or other special requirements.

Ordering Example

Order sheet D399E		Cam switches with special switching program		Customer:																																	
Switch Type M4H <input type="checkbox"/> M10 <input type="checkbox"/> M10H <input checked="" type="checkbox"/> M20 <input type="checkbox"/> N20 <input type="checkbox"/> N33F L100 <input type="checkbox"/> N40 L160 <input type="checkbox"/> N61 L400 <input type="checkbox"/> N80 L600 <input type="checkbox"/> N100 L800 <input type="checkbox"/> N200 L1200 <input type="checkbox"/>		Benedict GmbH A-1220 Vienna, Liebgasse 7 Phone: 251 51-0 Fax: 251 51-88																																			
Design Panel mounting E <input type="checkbox"/> Central fixing Z <input checked="" type="checkbox"/> ZO <input type="checkbox"/> Base mounting V <input type="checkbox"/> Snap-on mount SM <input type="checkbox"/> SMA <input type="checkbox"/> Plastic enclosure P <input type="checkbox"/> IP65 PF <input type="checkbox"/> Cast enclosure G <input checked="" type="checkbox"/> IP65 GF <input type="checkbox"/>		Explanations: Contact closed over several positions <input checked="" type="checkbox"/> Spring return from pos. <input type="checkbox"/>		Handles Twist knob R (standard) <input type="checkbox"/> Instrument knob G (standard M4H) <input checked="" type="checkbox"/> Toggle knob K (standard SMA) <input type="checkbox"/> Pointer knob Z <input type="checkbox"/> Ball type handle B <input type="checkbox"/> Lever handle H <input type="checkbox"/> Hand wheel HR <input type="checkbox"/>																																	
				Handle colour black (standard) <input checked="" type="checkbox"/> red <input type="checkbox"/> grey (standard SMA) <input type="checkbox"/> white <input type="checkbox"/> cream-coloured <input type="checkbox"/> yellow <input type="checkbox"/> blue <input type="checkbox"/>																																	
Optional extras Circular switch <input type="checkbox"/> Key removeable <input type="checkbox"/>		<table border="1"> <thead> <tr> <th>Marking for switch position</th> <th>Degree</th> <th colspan="2"></th> </tr> </thead> <tbody> <tr> <td>OFF</td> <td>270</td> <td></td> <td></td> </tr> <tr> <td>1</td> <td>0</td> <td><input checked="" type="checkbox"/></td> <td><input checked="" type="checkbox"/></td> </tr> <tr> <td></td> <td>45</td> <td><input checked="" type="checkbox"/></td> <td><input checked="" type="checkbox"/></td> </tr> <tr> <td>2</td> <td>90</td> <td><input checked="" type="checkbox"/></td> <td><input checked="" type="checkbox"/></td> </tr> <tr> <td>START</td> <td>120</td> <td><input checked="" type="checkbox"/></td> <td><input checked="" type="checkbox"/></td> </tr> </tbody> </table>		Marking for switch position	Degree			OFF	270			1	0	<input checked="" type="checkbox"/>	<input checked="" type="checkbox"/>		45	<input checked="" type="checkbox"/>	<input checked="" type="checkbox"/>	2	90	<input checked="" type="checkbox"/>	<input checked="" type="checkbox"/>	START	120	<input checked="" type="checkbox"/>	<input checked="" type="checkbox"/>	<table border="1"> <thead> <tr> <th>Connect.</th> <th>Terminals</th> <th>Connect.</th> <th>Terminals</th> </tr> </thead> <tbody> <tr> <td></td> <td>1 3 5 7 9 11 13 15 17 19 21 23 25 27 29 31 33 35 37 39 41 43 45 47</td> <td></td> <td>2 4 6 8 10 12 14 16 18 20 22 24 26 28 30 32 34 36 38 40 42 44 46 48</td> </tr> </tbody> </table>		Connect.	Terminals	Connect.	Terminals		1 3 5 7 9 11 13 15 17 19 21 23 25 27 29 31 33 35 37 39 41 43 45 47		2 4 6 8 10 12 14 16 18 20 22 24 26 28 30 32 34 36 38 40 42 44 46 48
Marking for switch position	Degree																																				
OFF	270																																				
1	0	<input checked="" type="checkbox"/>	<input checked="" type="checkbox"/>																																		
	45	<input checked="" type="checkbox"/>	<input checked="" type="checkbox"/>																																		
2	90	<input checked="" type="checkbox"/>	<input checked="" type="checkbox"/>																																		
START	120	<input checked="" type="checkbox"/>	<input checked="" type="checkbox"/>																																		
Connect.	Terminals	Connect.	Terminals																																		
	1 3 5 7 9 11 13 15 17 19 21 23 25 27 29 31 33 35 37 39 41 43 45 47		2 4 6 8 10 12 14 16 18 20 22 24 26 28 30 32 34 36 38 40 42 44 46 48																																		

Order sheet A4 see page 275

Utilization Categories

For easier choice of devices and in order to make the comparison of different products simpler are utilization categories for cam switches according to IEC 947-3, VDE 0660 Part 107 and

auxiliary contacts according to IEC 947-5-1 and VDE 0660 Part 200 determined. The Table below offers diverse utilization categories and assorted test conditions.

Kind of current	Category		Typical applications	Rated operational current	Test conditions for the number of on-load operating cycles (normal service)						Test conditions for making and breaking capacities (operation in fault case)					
	fre-quent operation	infre-quent operation			Make			Break			Make			Break		
					I/I _e	U/U _e	cosφ	I _c /I _e	U _r /U _e	cosφ	I/I _e	U/U _e	cosφ	I _c /I _e	U _r /U _e	cosφ
Alternating Current	AC20A	AC20B	No-load conditions	all values	-	-	-	-	-	-	-	-	-	-	-	-
	AC21A	AC21B	Switching of resistive loads including moderate overloads	all values	1	1	0,95	1	1	0,95	1,5	1,05	0,95	1,5	1,05	0,95
	AC22A	AC22B	Switching of mixed resistive and inductive loads including moderate overloads	all values	1	1	0,8	1	1	0,8	3	1,05	0,65	3	1,05	0,65
	AC23A	AC23B	Switching of motor loads or other highly inductive loads	0 < I _e ≤ 100A all values 100A < I _e	1	1	0,65	1	1	0,65	10	1,05	0,45	8	1,05	0,45
	AC2		Slip-ring motors: Starting, plugging	all values	2,5	1	0,65	2,5	1	0,65	4	1,05	0,65	4	1,05	0,65
	AC3		Squirrel-cage motors: Starting, switching off motors during running	0 < I _e ≤ 100A all values 100A < I _e	I _e ≤ 17A 6 1 I _e > 17A	0,65	I _e ≤ 17A 1 0,17 I _e > 17A	0,65	10	1,05	0,45	8	1,05	0,35	0,45	0,35
	AC4		Squirrel-cage motors: Starting, plugging, inching	0 < I _e ≤ 100A all values 100A < I _e	I _e ≤ 17A 6 1 I _e > 17A	0,65	I _e ≤ 17A 6 1 I _e > 17A	0,65	12	1,05	0,45	10	1,05	0,35	0,45	0,35
	AC15		Control of electromagnetic loads (> 72VA)	-	10	1	0,7	1	1	0,4	10	1,1	0,3	10	1,1	0,3
					I/I _e	U/U _e	L/R ¹⁾	I _c /I _e	U _r /U _e	L/R ¹⁾	I/I _e	U/U _e	L/R ¹⁾	I _c /I _e	U _r /U _e	L/R ¹⁾
Direct current	DC20A	DC20B	No-load conditions	all values	-	-	-	-	-	-	-	-	-	-	-	-
	DC21A	DC21B	Switching of resistive loads including moderate overloads	all values	1	1	1	1	1	1	1,5	1,05	1	1,5	1,05	1
	DC22A	DC22B	Switching of mixed resistive a. induct. loads incl. moderate overloads (shunt motors)	all values	1	1	2	1	1	2	4	1,05	2,5	4	1,05	2,5
	DC23A	DC23B	Switching of highly inductive loads (e.g. series motors)	all values	1	1	7,5	1	1	7,5	4	1,05	15	4	1,05	15
	DC3		Shunt-motors: Starting, plugging, inching	all values	2,5	1	2	2,5	1	2	4	1,05	2,5	4	1,05	2,5
	DC5		Series-motors: Starting, plugging, inching	all values	2,5	1	7,5	2,5	1	7,5	4	1,05	15	4	1,05	15

U_e Rated operational voltage, U Voltage before make, U_r Recovery voltage, I_e Rated operational current, I Current made, I_c Current broken
1) Time in milliseconds (ms)

Note:
By plugging, is understood stopping or reversing the motor rapidly by reversing motor primary connections while the motor is running.
By inching (jogging), is understood energizing a motor once or repeatedly for short periods to obtain small movements of the driven mechanism.

Technical Data

Data according to IEC 947-3, IEC 947-5-1, VDE 0660, EN 60947-3, EN 60947-5-1

Type	M10 P	M10H	M10HD	M20	N20	N33F	N40	N61	N80	N100	N200
Rated therm. current I_{th} open A	20	20	10	32	32	50	63	90	115	150	250
Rated therm. current I_{the} encl. A	20	20	10	32	32	50	63	90	115	150	250
Rated operational voltage U_e V	440	690 ¹⁾	690 ¹⁾	690 ¹⁾	690 ¹⁾	690 ¹⁾	690 ¹⁾	690 ¹⁾	690 ¹⁾	690 ¹⁾	690 ¹⁾
Disconnection property ²⁾ acc. to VDE, IEC up to V	440	440	440	440	440	440	690	440	440	690	690
Breaking capacity I_{eff}											
3 x 220-440V A	160	160	-	220	220	260	380	520	740	900	1100
3 x 500V A	-	100	-	160	160	200	290	380	560	680	850
3 x 660-690V A	-	80	-	120	120	150	200	290	520	450	-
Utilization categ. AC21A, AC21B Switching of resistive loads including moderate overloads											
Rated operational current I_e A	20	20	10	32	32	50	63	90	115	150	250
Utilization categ. AC23A, AC23B Switching of motor loads or other highly inductive loads											
Rated current I_e 400V A	16	16	-	30	30	45	45	60	85	105	135
Power rating 220-240V kW	4	4	-	7,5	7,5	11	15	22	30	40	40
3-phase 3-pole 380-440V kW	7,5	7,5	-	15	15	22	22	30	45	55	70
500V kW	-	7,5	-	15	15	22	22	30	45	55	70
660-690V kW	-	7,5	-	15	15	22	18,5	30	45	45	-
Star-Delta-Switches for squirrel cage motors											
Power rating 3-phase 3-pole 220-240V kW	3,7	3,7	-	7,5	7,5	8	11	15	18,5	37	40
380-415V kW	7,5	7,5	-	15	15	18,5	18,5	25	30	40	70
Utilization category AC3 Switching of three-phase motors											
Rated current I_e 400V A	12	12	-	22	22	30	30	50	60	80	135
Power rating 220-240V kW	3	3	-	5,5	5,5	7,5	7,5	15	18,5	37	40
3-phase 3-pole 380-440V kW	5,5	5,5	-	11	11	15	15	25	30	40	70
500V kW	-	5,5	-	11	11	15	15	25	30	40	70
660-690V kW	-	5,5	-	11	11	15	15	25	30	40	-
Utilization category AC4 squirrel cage motors, inching											
Power rating 220-240V kW	0,55	0,55	-	2,2	2,2	3,7	4	5,5	6	11	18,5
3-phase 3-pole 380-440V kW	1,5	1,5	-	4	4	5,5	7,5	11	15	18,5	35
500V kW	-	1,5	-	4	4	5,5	7,5	11	15	22	35
660-690V kW	-	1,5	-	4	4	5,5	7,5	11	15	22	-
Utilization category AC15 Control of electromagnetic loads, contactors,											
Rated current I_e up to 240V A	6	6	2,5	12	12	16	-	-	-	-	-
380 - 440V A	4	4	1,5	6	6	7	-	-	-	-	-
2-pole in series 500V A	-	5	-	8	8	10	-	-	-	-	-
Utilization categ. DC21A, DC21B Switching of resistive loads											
Time constant L/R \leq 1ms											
Rated current I_e 1-pole 30V A	20	20	10	32	32	40	63	80	100	150	250
60V A	4	4	-	6	6	20	30	30	30	-	-
110V A	0,6	0,6	-	3	3	4	6	6	6	-	-
220V A	0,5	0,5	-	0,8	0,8	0,8	1,3	1,3	1,3	2,5	2,5
440V A	-	-	-	0,4	0,4	0,4	0,6	0,6	0,6	0,7	0,7
Utilization category DC3 - DC5 Switching of shunt motors and series motors											
Time constant L/R \leq 15ms											
Rated current I_e 1-pole 30V A	8	8	-	13	13	16	25	32	40	60	100
60V A	1	1	-	2,4	2,4	4	12	12	12	-	-
110V A	0,3	0,3	-	0,5	0,5	1,6	2,4	2,4	2,4	-	-
Protection class of terminals ³⁾	IP00	IP20	IP20	IP00	IP00	IP20	IP00	IP00	IP00	IP00	IP00

1) suitable for: earthed-neutral systems, overvoltage category I to III, pollution degree 3 (standard-industry): $U_{imp} = 6kV$. Data for other conditions on request

2) valid for lines with grounded common neutral termination, overvoltage category III, pollution degree 3.

3) Protection degree of the terminals with connected insulated conductor. Additional protection with terminal cover (KLAD).

Technical Data

Data according to IEC 947-3, IEC 947-5-1, VDE 0660, EN 60947-3, EN 60947-5-1

Type		M10 P	M10H	M10HD	M20	N20	N33F	N40	N61	N80	N100	N200
Cable cross-sections												
solid	mm ²	1-2,5	1-2,5 ¹⁾	1,5-6	1,5-6	1,5-6	2,5-10	2,5-16 ¹⁾	6-25 ¹⁾	6-35	10-50 ¹⁾	50-150
flexible	mm ²	0,75-2,5	0,75-2,5 ¹⁾	1-4	1-4	1-4	1,5- 6	2,5-10 ¹⁾	6-25 ¹⁾	6-35	10-35 ¹⁾	35-120
flexible w. multicore cable end	mm ²	0,75-2,5	0,75-1,5	1-4	1-4	1-4	1,5- 6	2,5-6	6-16	6-35	10-25	-
Conductors to clamp per pole		2	2	2	2	2	2	2	1	1	1	1
Size of terminal screw		M3	M3,5	M4	M4	M4	M4	M5	2xM5	2xM5	2xM6	M10
Tightening torque	Nm lb.inch	0,6-1,2 5-11	0,8-1,4 7-12	1,2-1,8 11-16	1,2-1,8 11-16	1,2-1,8 11-16	1,2-1,8 11-16	2,5-3 22-26	2,5-3 22-26	2,5-3 22-26	3,5-4,5 31-40	10 88
Short circuit protection												
Max. fuse size	gL (gG) A	20	20	20	35	35	50	63	100	125	160	250
Rated short-time withstand current (1sec. current)	A	250	250	-	400	400	500	800	1000	1400	1800	3000
Rated conditional short-circuit current	kA _{eff}	10	10	1	10	10	10	10	10	10	10	10
Short-time capacity												
Load duration	3s A	100	100	-	200	200	350	400	600	720	1000	2000
	10s A	60	60	-	130	130	230	250	400	480	600	1200
Note: Ratings applies to contacts already closed	30s A	35	35	-	85	85	110	160	250	300	500	600
	60s A	25	25	-	65	65	80	110	200	250	370	480
Power loss at AC21A												
per pole	A W	20 0,6	20 0,5	10 0,5	32 0,9	32 1,1	50 1,9	63 2	85 2,8	115 4,4	150 5,7	250 21
Switching of capacitive loads												
maximum making capacity up to 500V	A	140	140	-	300	300	350	400	600	700	900	1800

Data according to UL and cUL

Type		M10 P	M10H	M10HD	M20	N20	N33F	N61	N80	N100	N200	L400
Rated voltage	V~	300	600	600	600	600	600	600	600	600	600	600
Rated operational current "General Use" with jumper	A A	20 15	20 -	10 -	35 25	35 25	60 40	90 60	115 80	130 -	250 -	350 -
DOL-Rating 3-phase	110-120V 200-208V 220-240V	hp hp hp	1½ 2 3	1½ 2 3	- 5 5	5 5 5	7½ 10 15	- - -	10 15 20	15 25 30	15 25 30	15 25 30
	440-480V 550-600V	hp hp	- 7½	5 -	10 15	10 15	25 30	- 40	40 50	40 50	60 75	60 75
DOL-Rating 1-phase	110-120V 200-208V 220-240V	hp hp hp	½ 1 1½	½ 1 1½	- 3 5	1½ 3 5	3 5 7½	- - -	5 7½ 10	7½ 15 15	7½ 15 20	7½ 15 20
Fuse size (RK5) Manual Motor Controller 5kA / 600V and Motor Disconnect	A	40 ²⁾	40	-	80	80	150	-	200	300	350	350
Heavy pilot duty	AC	A300	A600	A600	A600	A600	A600	-	-	-	-	-
Cable cross sections												
solid	AWG	12 - 20	12 - 20	10 - 18	10 - 18	10 - 18	10 - 12	10 - 12	10 - 12	10 - 14	-	-
flexible	AWG	14 - 20	14 - 20	8 - 18	8 - 18	8 - 18	6 - 12	2 - 12	2 - 12	1 - 14	250kcmil	500kcmil
Tightening torque	Nm lb.inch	1.7 15	1-1.7 9-15	1.7-2.8 15-25	1.7-2.8 15-25	1.7-2.8 15-25	2.3-2.8 20-25	2.8 25	2.8 25	4.5 40	- -	- -

1) Maximum cable cross-section with prepared conductor

2) 5kA / 300V

Technical Data

Data according to IEC 947-3, IEC 947-5-1, VDE 0660, EN 60947-3, EN 60947-5-1

Type		L100	L160	L400	L600	L800	L1200
Rated insulation voltage U_i	V	690 ²⁾	690 ²⁾	690 ²⁾	690 ²⁾	690 ²⁾	690 ²⁾
Rated thermal current I_{th} openA	125	180	400	600	800	1200	
Rated thermal current I_{the} encl. A	125	180	400	600	800	1200	
with conductor	mm ²	50	70	40x5	40x10	busbar 2x40x10	busbar 2x50x10
Utilization category AC21A, AC21B							
Switching of resistive loads, including moderate overloads							
Rated operational current I_e	A	125	180	400	400	400	400
Shot-time current-carrying capacity							
Load duration	1s	-	-	4800	6500	8500	10000
	3s	800	1200	3600	5000	6500	8000
	10s	500	800	2000	3200	4000	5800
Note: Ratings applies to contacts already closed	30s	320	480	1200	1700	2200	3200
	60s	180	380	960	1300	1700	2300
Cable cross-sections							
solid or stranded	mm ²	25-50 ¹⁾	cable lug	busbar	busbar	busbar	busbar
flexible	mm ²	25-50 ¹⁾	70	40x5	40x10	2x40x10	2x50x10
flexible with multicore cable end	mm ²	25-35	-	-	-	-	-
Size of terminal screw		2xM5	M8	M12	M16	M16	M16
Number of conductors to clamp per pole		1	1	1	2	1	1
Short circuit protection							
Max. fuse size	slow, gL (gG) A	125	200	400	630	800	1250

1) Maximum cable cross-section with prepared conductor

2) suitable for: earthed-neutral systems, overvoltage category I to III, pollution degree 3 (standard-industry): $U_{imp} = 6kV$. Data for other conditions on request

Dimensions (mm)

Panel mounting E M10 - N100

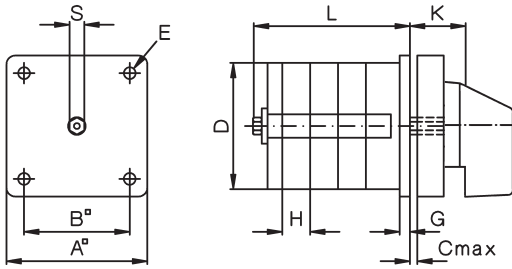

N200

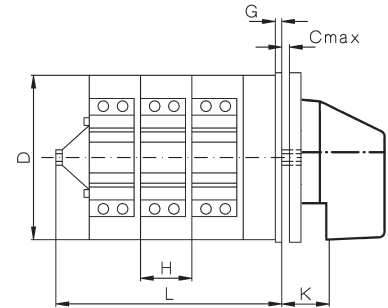
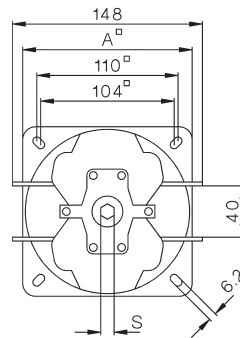

Type	A	B	C	D	D1	D2	D3	E	G	H	KS
M10H	48	36	5	44 ¹⁾	5	8	-	4	3,5	9,5	19
M20	48	36	5	56	5	8	57	4	3,5	12,5	19
N20	64	48	5	56	5	12	-	4,2	3	12,5	20
N33F	64	48	5	58 ²⁾	5	12	-	4,2	3	15,5	20
N40	86	68	7	80	6	12	82	5,2	3,5	18	24,5
N61	86	68	7	80	6	12	82	5,2	3,5	29,5	24,5
N80	86	68	7	80	6	12	82	5,2	3,5	29,5	24,5
N100	132	110	9	128	7	16	129	6,2	5	30	37
N200	132	110	9	128	7	16	-	6,2	5	40	37

1) 44,5 x 42

Mounting holes: built in from ear
Mounting screw: J3631N M=1,2-1,4 Nm

2) 58 x 58

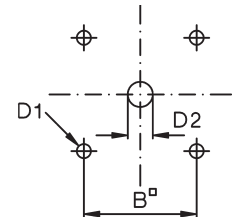

Mounting holes: built in from front

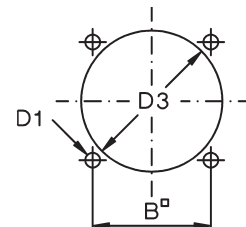

Type	Dimension L with .. cells														
	1	2	3	4	5	6	7	8	9	10	11	12	13	14	15
M10H	36,5	46	55,5	65	74,5	84	93,5	103	112,5	122	131,5	141	-	-	-
M20	38,5	51	63,5	76	88,5	101	113,5	126	138,5	151	163,5	176	-	-	-
N20	40,5	53	65,5	78	90,5	103	115,5	128	140,5	153	165,5	178	190,5	203	215,5
N33F	44	59,5	75	90,5	106	121,5	137	152,5	168	183,5	199	214,5	230	245,5	261
N40	52,5	70,5	88,5	106,5	124,5	142,5	160,5	178,5	196,5	214,5	232,5	250,5	268,5	286,5	304,5
N61	64	93,5	123	152,5	182	211,5	241	270,5	300	329,5	359	388,5	-	-	-
N80	64	93,5	123	152,5	182	211,5	241	270,5	300	329,5	359	388,5	-	-	-
N100	88	118	148	178	208	238	268	298	328	358	388	418	-	-	-
N200	96	136	176	216	256	296	336	376	416	456	496	536	-	-	-

Central fixing Z M10H, M20, N33F

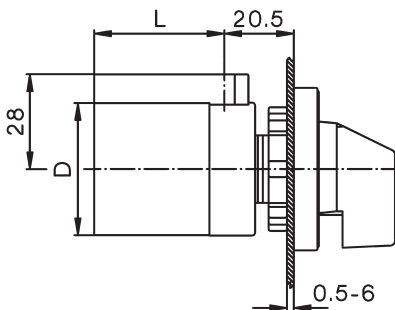

Central fixing without escutcheon plate ZO M10H, M20

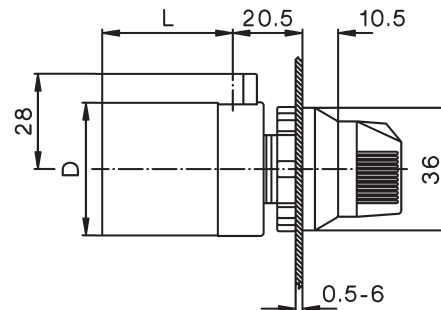

Mounting hole:

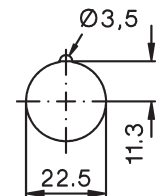

Further dimensions see tables above

Mini-Cam Switches M4H

Panel mounting E

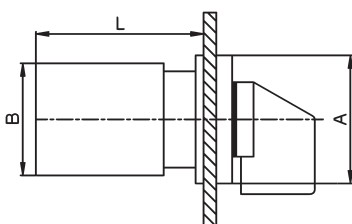

Central fixing Z, ZO

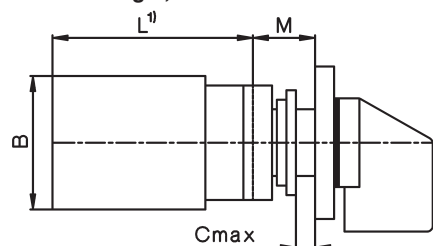

ZO

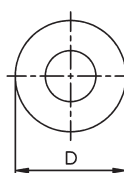

Z

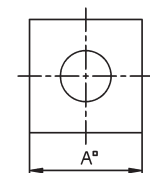

Typ	A	B	D	M	Dimension L with .. cells								
					1	2	3	4	5	6	7	8	
M4H	mm	30	28	29,5	12,5	38,5	50,5	62,5	74,5	86,5	98,5	110,5	122,5

Mounting holes see page 236

Flush mounting UP M10

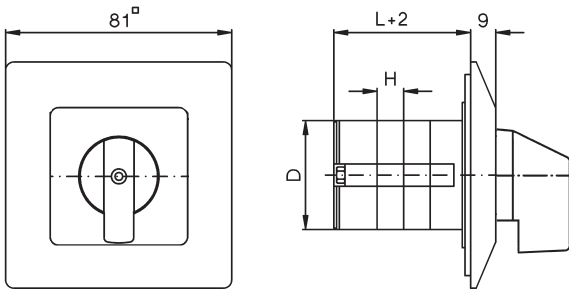

Base mounting V M10H - N100

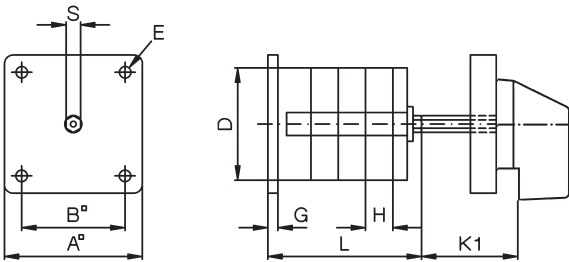

N200

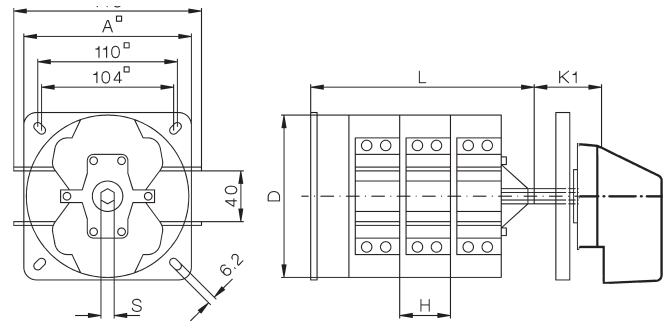

Type	A	B	D	D1	D2	E	G	H	I	K	K1	
M10	48	36	39	5	8	4	3,5	9,5	6	19	41	SW5
M10H	48	36	44 ¹⁾	5	8	4,2	3	9,5	6	19	41	SW5
M20	48	36	56	5	8	4,2	3	12,5	6	19	47	SW5
N20	64	48	56	5	12	4,2	3	12,5	0	20	29	SW7
N33F	64	48	58 ²⁾	5	12	4,2	3	15,5	0	20	31,5	SW7
N40	86	68	80	6	12	5,2	3,5	18	-	-	38,5	SW9
N61	86	68	80	6	12	5,2	3,5	29,5	-	-	49,5	SW9
N80	86	68	80	6	12	5,2	3,5	29,5	-	-	49,5	SW9
N100	132	110	128	7	16	6,2	5	30	-	-	79,5	SW12
N200	132	110	128	7	16	6,2	5	40	-	-	104	SW12

Mounting holes: for escutcheon plate

1) 42 x 44,5

2) 58 x 58

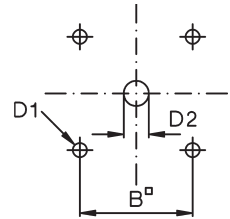

Type	Dimensions L with .. cells														
	1	2	3	4	5	6	7	8	9	10	11	12	13	14	15
M10	34,5	44	53,5	63	72,5	82	91,5	101	110,5	120	129,5	139	-	-	-
M10H	36,5	46	55,5	65	74,5	84	93,5	103	112,5	122	131,5	141	-	-	-
M20	38,5	51	63,5	76	88,5	101	113,5	126	138,5	151	163,5	176	-	-	-
N20	40,5	53	65,5	78	90,5	103	115,5	128	140,5	153	165,5	178	190,5	203	215,5
N33F	44	59,5	75	90,5	106	121,5	137	152,5	168	183,5	199	214,5	230	245,5	261
N40	52,5	70,5	88,5	106,5	124,5	142,5	160,5	178,5	196,5	214,5	232,5	250,5	268,5	286,5	304,5
N61	64	93,5	123	152,5	182	211,5	241	270,5	300	329,5	359	388,5	-	-	-
N80	64	93,5	123	152,5	182	211,5	241	270,5	300	329,5	359	388,5	-	-	-
N100	88	118	148	178	208	238	268	298	328	358	388	418	-	-	-
N200	96	136	176	216	256	296	336	376	416	456	496	536	-	-	-

Snap-on mounting SM M10H - N33F for 35mm DIN-rail mounting according to DIN EN 50022

Dimensions see tables above

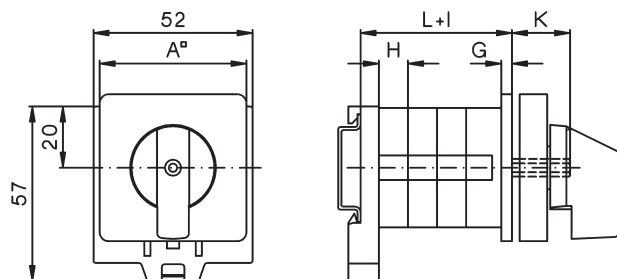

Switch with installation cover SMA M10H, M20 for 35mm DIN-rail mounting according to DIN EN 50022

Type	Dimension X with .. cells					Dimension Y with .. cells				
	1, 2	3	4	5	1, 2	3	4	5		
M10H	44	44	61	76	60	60	75	90		
M20	44	61	76	76	60	75	90	90		

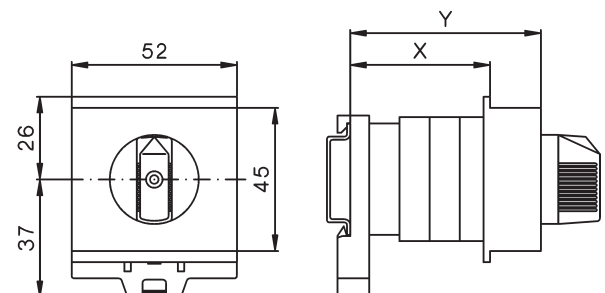

**Plastic enclosed switches P, PF
M10 - N61**

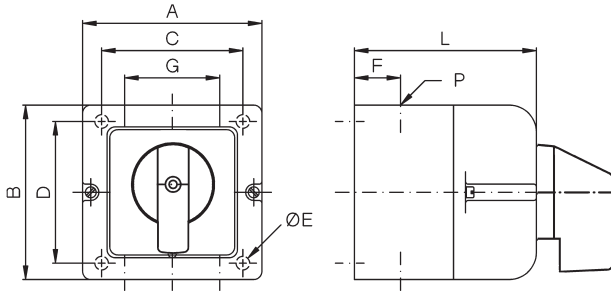

N100, N200

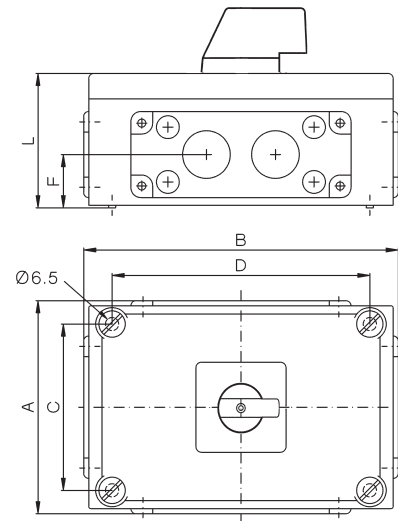

N61, N80

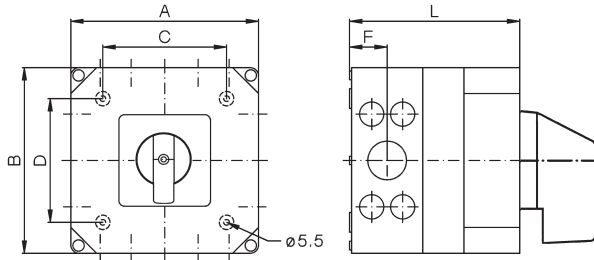

1) knock outs for M40/M32 + 4x M20 at top and bottom
M32/M25 + 4x M20 at the right and left hand side,

2) 2 flange plates with hole 50,5 at top and bottom

3) 2 flange plates with hole 50,5 at top and bottom, can also be mounted at the right and left hand side

Type	A	B	C	D	E	F	G	P	Dimension L with .. cells					
									1	2	3	4	5	6
M10	66	64	50	36	5	15,5	26	M20	43	52	62	71	81	90
N20	82	78	57	53	4,5	17	29	M20	66	66	80	94	108	122
N33F	112	108	85	50	5	20	50	M25	92	92	92	110	128	146
N40	112	108	85	50	5	20	50	M25	92	92	110	128	146	164
N61	112	108	85	50	5	20	50	M25	92	110	-	-	-	-
N61	182	180	120	120	5,5	36,5	-	1)	-	-	165	215	215	-
N80	182	180	120	120	5,5	36,5	-	1)	110	110	165	215	215	-
N100	210	310	165	255	6,5	52,5	-	2)	130	130	180	-	-	-
N200	310	310	255	255	6,5	52,5	-	3)	130	180	230	-	-	-

**Motor terminal box mounting KE
M10 - N33F**

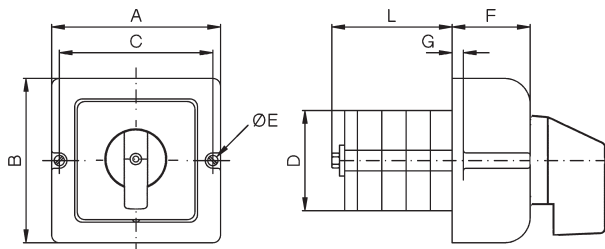

Mounting holes

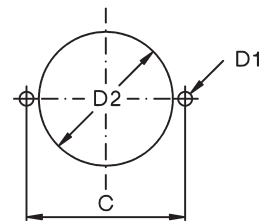

Type	A	B	C	D	D1	D2	E	F	G	Dimension L with .. cells					
										2	3	4	5	6	
M10	66	64	58	39	4	48	3,2	24	6	22	31,5	41	50,5	60	
N20	82	78	71	48	5	57	4,2	34	5	24,5	37	49,5	62	74,5	
N33F	112	108	100	56	5	70	4,2	49	11	32,5	48	63,5	79	94,5	

**Plastic enclosed motor starter PM
N20**

Typ	P	Dimension L with .. cells					
		1	2	3	4	5	6
N20	M25	80	80	80	92,5	105	117,5

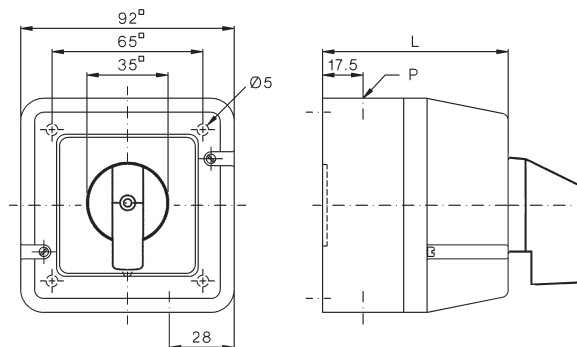

Cast aluminium enclosed switches G, GF N20

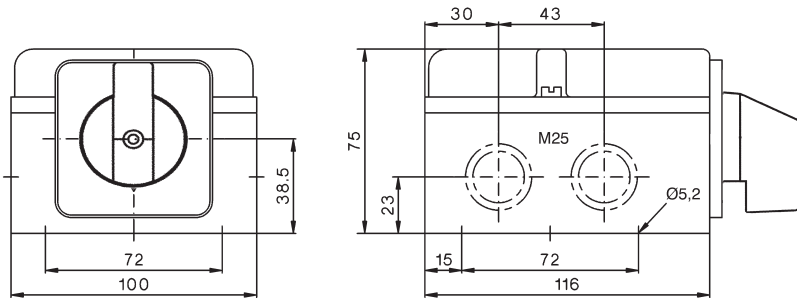

Plastic enclosure horizontal PLF (Replacement for cast aluminium enclosure G, GF) N40, N61, N80

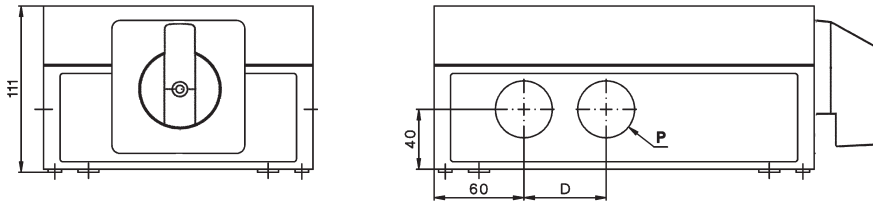

Type	N40 1 - 6 cells N61 1 - 3 cells N80 1 - 3 cells	N40 7 - 10 cells N61 4 - 6 cells N80 4 - 6 cells
A	182	254
B	167	239
C	120	190
D	-	65
P	2 x Ø40,5 (M40)	4 x Ø40,5 (M40)

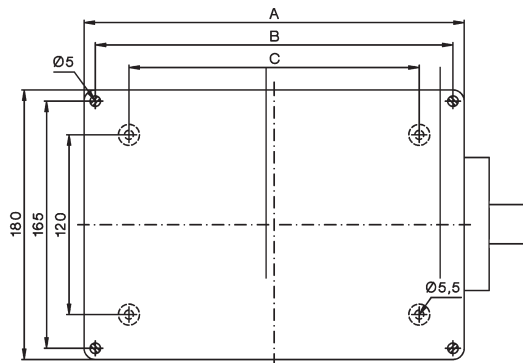

Load Switches

Panel mounting E
L100 - 400, L800, L1200

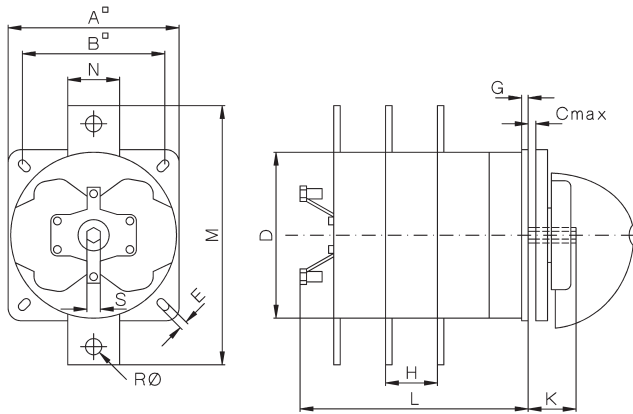

L600

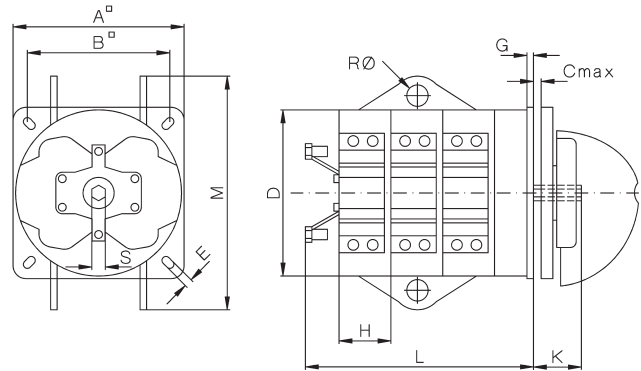

Base mounting V
L100 - 400, L800, L1200

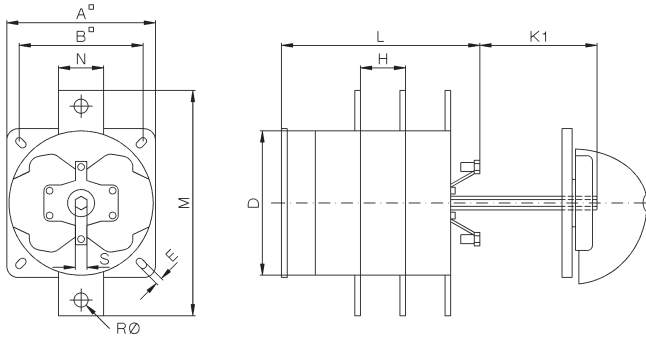

L600

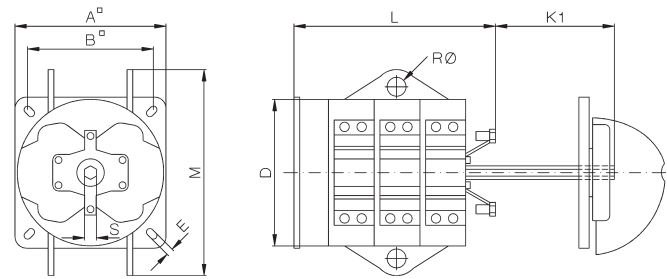

Type	A	B	C	D	D1	D2	E	G	H	K	K1	M	N	R	S
L100	86	68	7	80	6	12	5,2	3,5	18	24,5	38,5	103	27	-	SW9
L160	86	68	7	80	6	12	5,2	3,5	29,5	24,5	38,5	115	-	8,5	SW9
L400	132	110	9	128	7	16	6,2	5	40	37	104	200	40	12,5	SW12
L600	132	110	9	128	7	16	6,2	5	40	37	104	180	-	16,5	SW12
L800	132	110	9	128	7	16	6,2	5	40	37	104	240	40	16,5	SW12
L1200	132	110	9	128	7	16	6,2	5	40	37	104	240	40	16,5	SW12

Mounting holes:

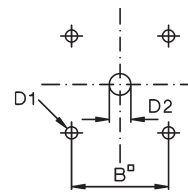

Type	Dimension L with .. cells											
	1	2	3	4	5	6	7	8	9	10	11	12
L100	52,5	70,5	88,5	106,5	124,5	142,5	160,5	178,5	196,5	214,5	232,5	250,5
L160	64	93,5	123	152,5	182	211,5	241	270,5	300	329,5	359	388,5
L400	96	136	176	216	256	296	336	376	416	456	496	536
L600	96	136	176	216	256	296	336	376	416	456	496	536
L800	96	136	176	216	256	296	336	376	416	456	496	536
L1200	96	136	176	216	256	296	336	376	416	456	496	536

Operating Knobs and Handles

Instrument knob G.

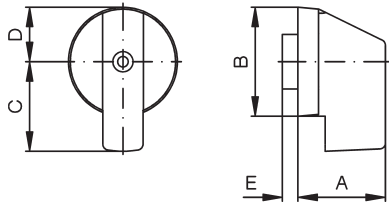

Type	A	B	C	D	E
M10, M10H, M20	23	28	24	14	4
N20, N33F	27	36	32	18	3
N40, N61, N80, L100, L160	36	47	42	24	3,5
N100, N200	48,10	75	63	37,5	-

Twist knob R.

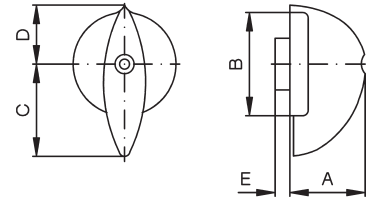

Type	A	B	C	D	E
M10, M10H, M20	20,5	28	25	15	4
N20, N33F	24	36	29,5	19	3
N40, N61, N80, L100, L160	31	49	41	28	3,5
N100, N200, L400, L600, L800, L1200	50	75	62	41	2,5

Toggle knob K.

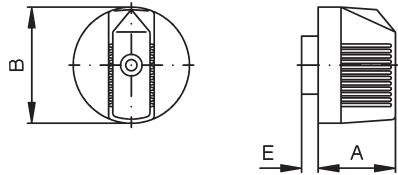

Type	A	B	E
M10, M10H, M20	18,5	28	4
N20, N33F	24	36	3

Hand wheel HR

N100, N200,
L400, L600, L800, L1200

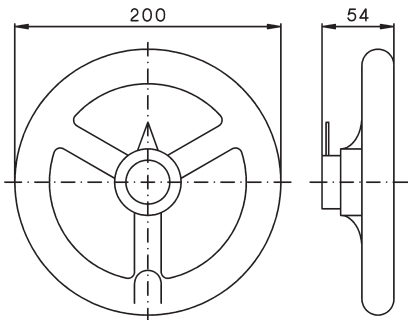

Ball type handle B.

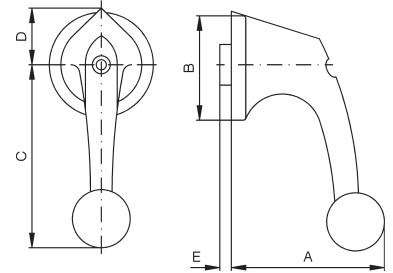

Type	A	B	C	D	E
N20, N33F	53	36,5	64	21	3
N40, N61, N80, L100, L160	62	49	82	31	3,5
N100, N200, L400, L600, L800, L1200	63	75	110	45	2,5

Code number for colour

grey	.1	white	.5
black	.2	blue	.6
red	.3	yellow	.7
cream-coloured	.4	euro-white	.8

Escutcheon plates

Escutcheon plate

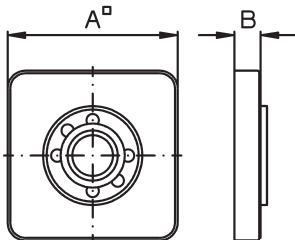

Type	A	B
M10, M10H, M20	48	7,5
N20, N33F	64	7,5
N40, N61, N80, L100, L160	88	8
N100, N200, L400, L600, L800, L1200	132	9

Rectangular additional plate SRE

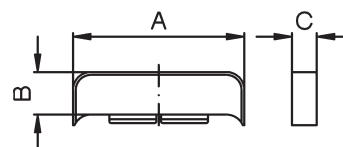

Type	A	B	C
M10, M10H, M20	48	12	7,5
N20, N33F	64	14	7,5
N40, N61, N80, L100, L160	88	22	8
N100, N200, L400, L600, L800, L1200	132	31	9

Special drives

**Removable knob drive STGR, STGR2
M10H - N33F**

Type	B	C	D1	D2	D3
M10H, M20	36	5	5	12	18
N20, N33F	48	5	5	12	18

Replace dimension D2 with dimension D3 for STGR2
Dimension L see page 262

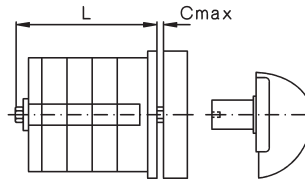
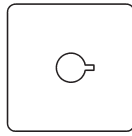

Mounting holes

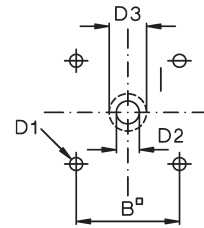

Door couplings

Dimension T is a minimum value. In case of order the dimension T is necessary.

**Door coupling TK, TKFR
N40 - L1200**

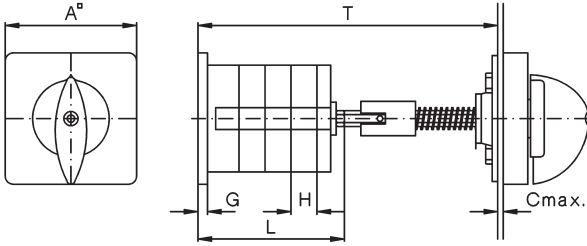

**Door coupling, lockable TK2, TK2FR
N40 - L1200**

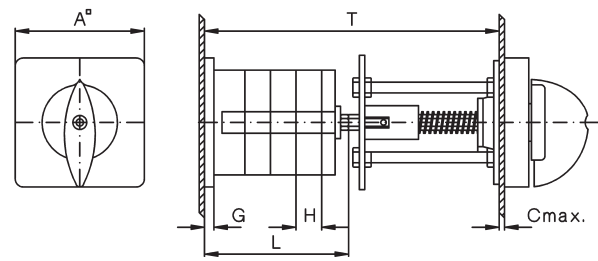

**Door coupling TKE, TK2E
M10H, M20, N20, N33F**

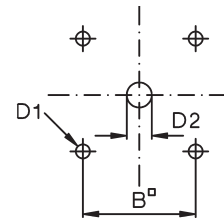
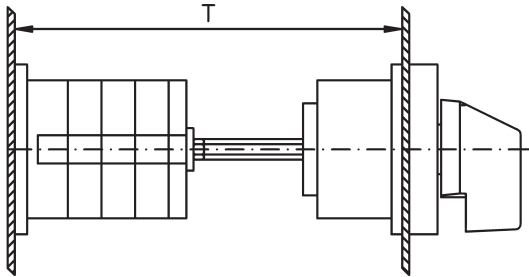

**Mounting holes:
TK, TKFR, TK2, TK2FR
TKE, TK2E**

**Door coupling, lockable TK2Z
M10H, M20, N20, N33F**

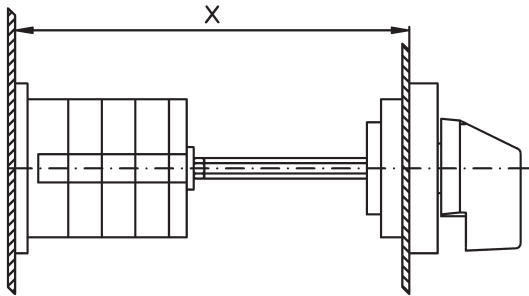

**Mounting holes:
TKZ**

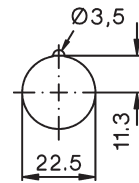

Further dimensions see pages 262 and 263.

Dimension T is a minimum value dependent on switch Type and number of cells. For ordering dimension T is necessary

Type	A	B	C	D1	D2	Minimum dimension T with .. cells							
						1	2	3	4	5	6	7	8
M10H	48	36	5	5	8	108	117,5	127	136,5	146	155,5	165	174,5
M20	48	36	5	5	8	100	112,5	125	137,5	150	162,5	175	187,5
N20	64	48	5	5	10	100	112,5	125	137,5	150	162,5	175	187,5
N33F	64	48	5	5	10	103	118,5	134	149,5	165	180,5	196	211,5
N40	88	48	7	6	12	134	152	170	188	206	224	242	260
N61	88	48	7	6	12	145,5	175	245,5	234	263,5	293	322,5	352
N80	88	48	7	6	12	145,5	175	245,5	234	263,5	293	322,5	352
N100	132	110	9	7	15	202	232	262	292	322	352	382	412
N200	132	110	9	7	15	212	252	292	332	372	412	452	492
L100	88	48	7	6	12	-	152	-	188	-	224	-	260
L160	88	48	7	6	12	145,5	175	245,5	234	263,5	293	322,5	352
L400	132	110	9	7	15	212	252	292	332	372	412	452	492
L600	132	110	9	7	15	-	-	292	-	-	412	-	-
L800	132	110	9	7	15	-	252	-	332	-	412	452	492
L1200	132	110	9	7	15	-	-	292	-	-	412	-	-

Key operated switches SA

Panel mounting E
M10 - N61

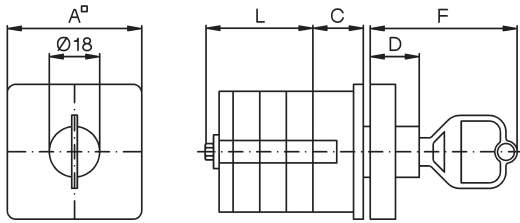

Type	A	B	C	D	D1	D2	F
M10H, M20	48	36	18	17,5	5	18,5	52,5
N20, N33F	64	48	10	17,5	5	18,5	52,5
N40, N61	88	68	23,5	15	6	18,5	50

Mounting holes

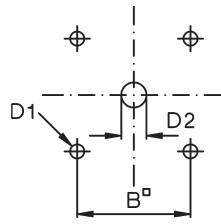

Dimension L see page 262

Base mounting V
M10 - N61

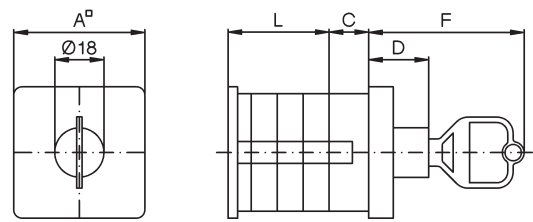

Type	A	C	D	F
M10H, M20	48	18	22	57
N20, N33F	64	8	22	57
N40, N61	88	15	15	50

Dimension L see page 263

Central fixing Z
M10H Z ... + SA
M20 Z ... + SA

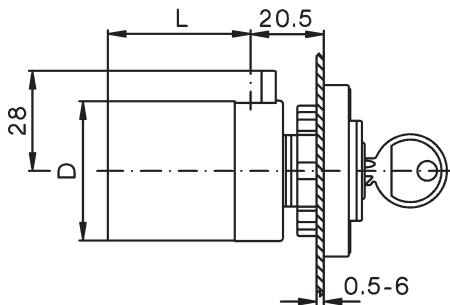

Central fixing without escutcheon plate ZO
M10H ZO ... + SA
M20 ZO ... + SA

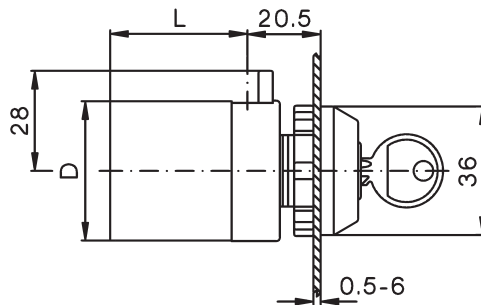

Mounting holes:

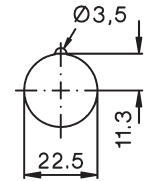

Further dimensions see page 262

DIN rail mounting SMA
M10H, M20

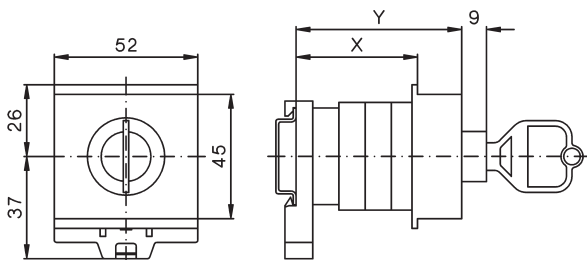

Type	Dimension X with .. cells				Dimension Y with .. cells			
	1	2	3	4	1	2	3	4
M10H	44	75	75	91	60	90	90	107
M20	59	75	75	91	75	90	90	107

Flush mounting UP
M10

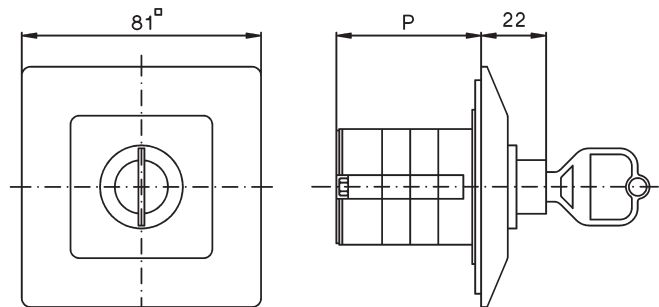

Type	Dimension P with .. cells	
M10	1	2
M10	47,5	57

Plastic enclosed switches P, PF
M10, N20, N33F, N40, N61

Type	Dimension P with .. cells			
	1	2	3	4
M10	62	71	81	90
N20	66	80	94	108
N33F	92	110	110	128
N40	92	110	-	-
N61	110	-	-	-

Further dimensions see page 264

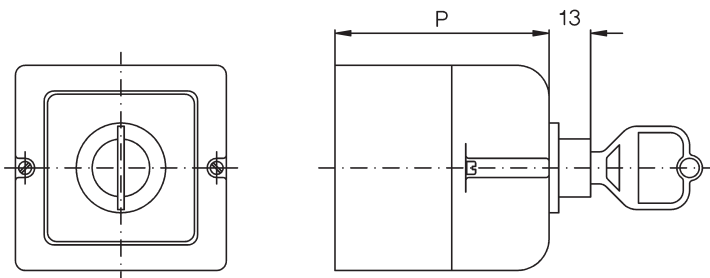

Key operated switches

Key operated switch SAK
Panel mounting E M10H, M20

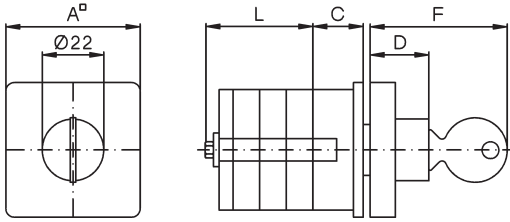

Type	A	B	C	D	D1	D2	F
M10H, M20	48	36	25	21	5	22,5	49

Mounting holes

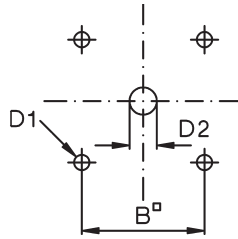

Key operated switch SAK
Base mounting V M10H, M20

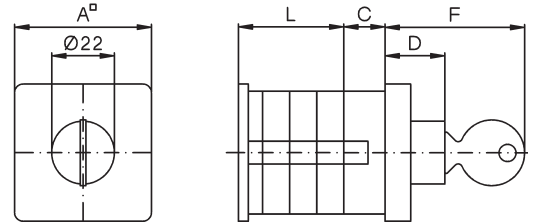

Type	A	C	D	F
M10H, M20	48	25	21	49

Key operated switch SASI
Panel mounting E M10, M20

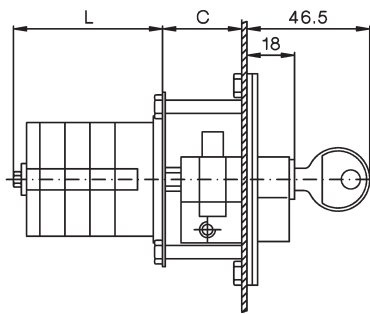
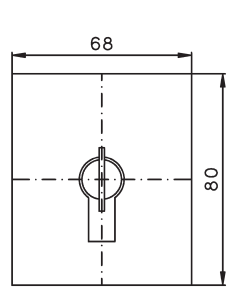

Mounting holes M10, M20

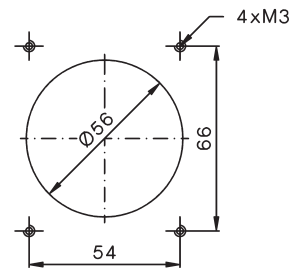

Type	M10	M20
C	20	20

Dimension L see page 262

Key operated switch SASI
Plastic enclosed P M10, M20

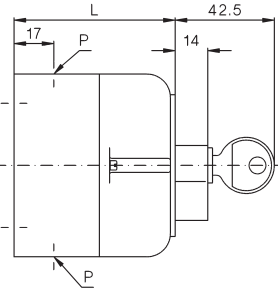
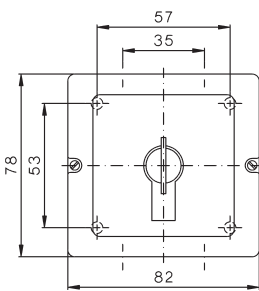

Typ	Dimension P with .. cells				P
	1	2	3	4	
M10	67	79,5	92	104,5	2xM20
M20	79,5	92	104,5	117	2xM20

Key operated switch SASI
Flush mounting UP M10, M20

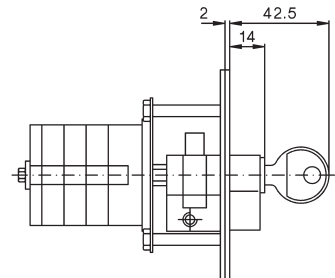
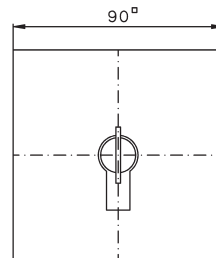

Padlock devices

Padlock device SV1 (max. 2 padlocks with stirrup Ø6mm)
M10H, M20
Mounting holes design E, V

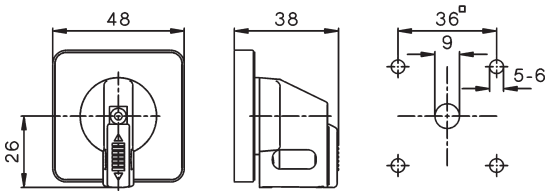

Padlock device SV164
M10H - N33F
Mounting holes design E, V

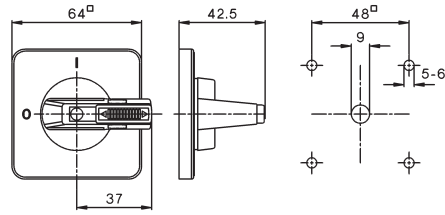

Padlock device SV3 (max. 3 padlocks with stirrup Ø8,5mm)
Panel mounting E
N20 - N200, L100 - L1200

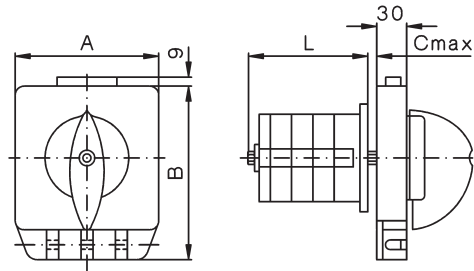

Base mounting V
N20 - N200, L100 - L1200

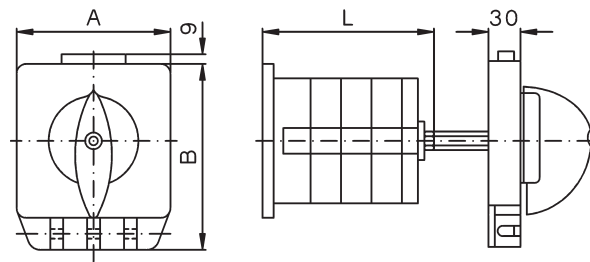

Further dimensions see page 263

Type	A	B	C
N20, N33F	102	128	5
N40, N61, N80, L100, L160	102	128	7
N100, N200, L400, L600, L800, L1200	132	159	9

Padlock device SV4 (max. 3 padlocks with stirrup Ø6mm)
M10H - N33F

Mounting holes design E, V

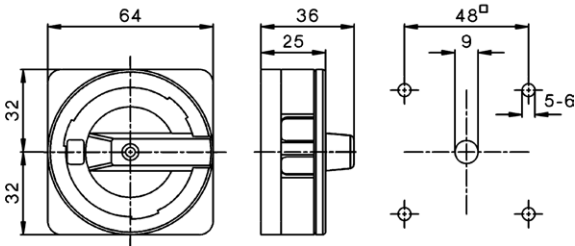

Padlock device SV4 (max. 3 padlocks with stirrup Ø6mm)
N40 - N80, L100 - L160
Padlock device SV488
N20, N33F

Mounting holes design E, V

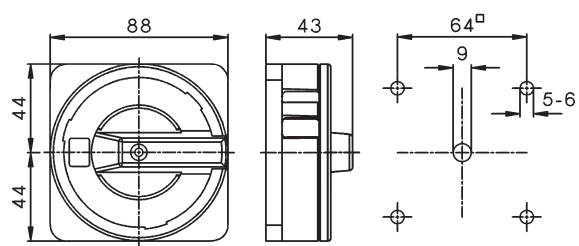

Front plate/switch shaft sealing FPWD
N20, N33F

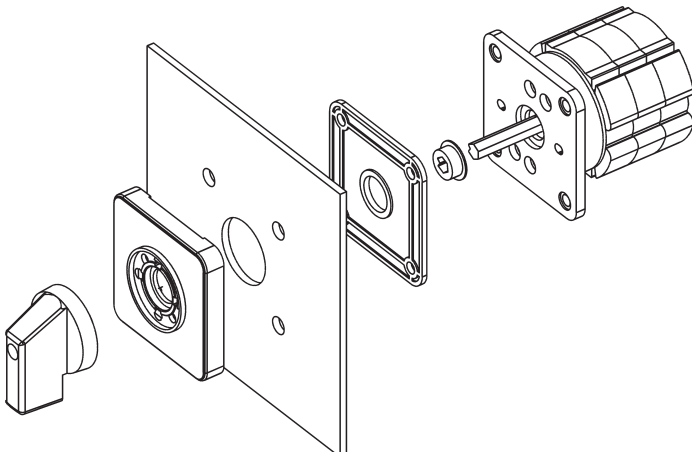

Mounting holes

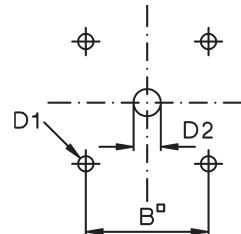

Typ	B	D1	D2
N20, N33F	48	5	17

Interlocks

Lock switch SZ, SZ2 Panel mounting E

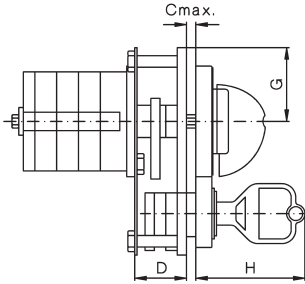
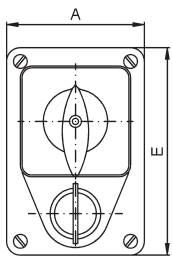

Base mounting V

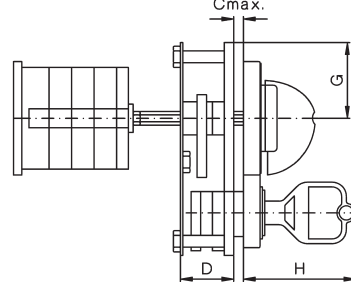
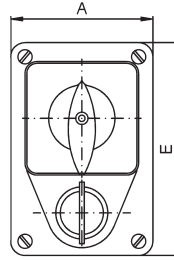

Mounting holes

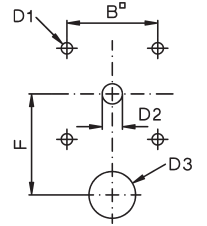

Type	A	B	C	D	D1	D2	D3	E	F	G	H
M10H, M20	60	36	3	22,5	5	8	18,5	90	40	32	47,5
N20, N33F	60	36	3	22,5	5	12	18,5	90	45	32	47,5
N40, N61, N80, L100, L160	90	68	4	24	6	12	18,5	142	61	61,5	48
N100, N200, L400, L600, L800, L1200	140	110	4	27	7	15	18,5	180	83	90,5	49

Push-button switch lock DV

Switch interlock with electrical contact ET Panel mounting E

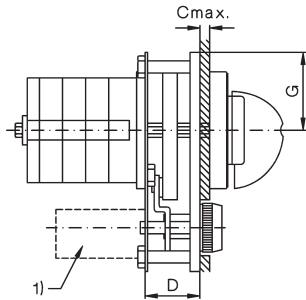
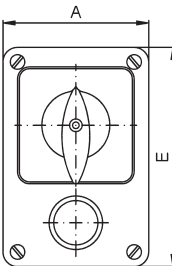

Base mounting V

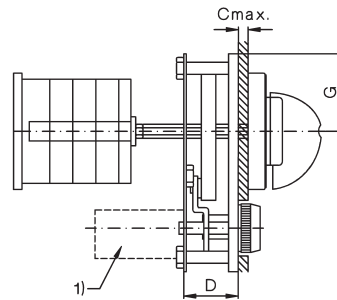
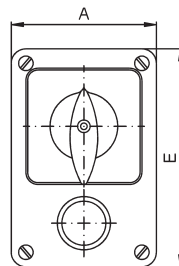

Mounting holes

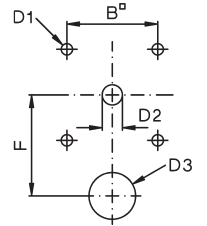

Type	A	B	C	D	D1	D2	D3	E	F	G
M10H, M20	60	36	3	22,5	5	8	26	90	45	32
N20, N33F	60	36	3	22,5	5	10	26	90	45	32
N40, N601 N80, L100, L160	90	68	4	25	6	12	29	142	61	61,5
N100, N200, L400, L600, L800, L1200	140	110	4	41	7	15	29	180	83	90,5

1) only at +ET

Moisture proofing caps for panel switches FR M10H

Type	Dimension L with .. cells						
	1	2	3	4	5	6	7
M10H	55	55	75	75	88	106	106

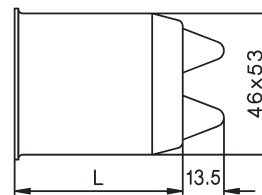
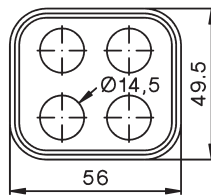

Moisture proofing caps for panel switches FR N20, N40, N61

Type	A	B	D	E	Dimension L with .. cells				
					1	2	3	4	5
N20	60	48	59	5,5	68	68	68	91	91
N40	87	68	83	5,5	82	82	117	117	-

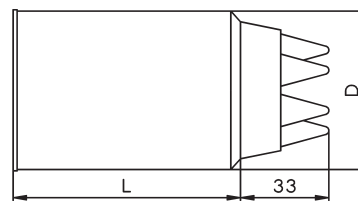
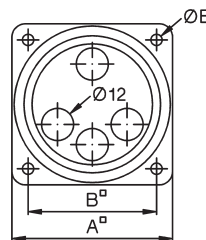

Interlocks

Geared switch with two columns ZK2
Panel mounting E

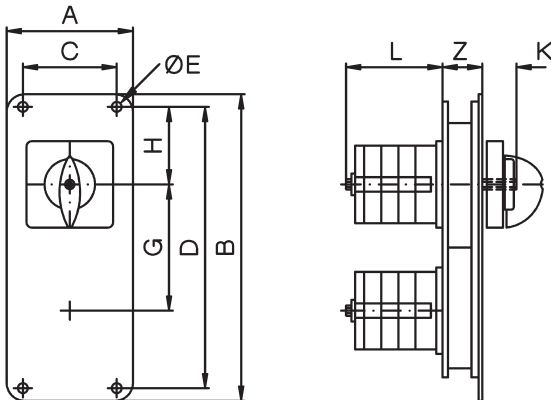

Base mounting V

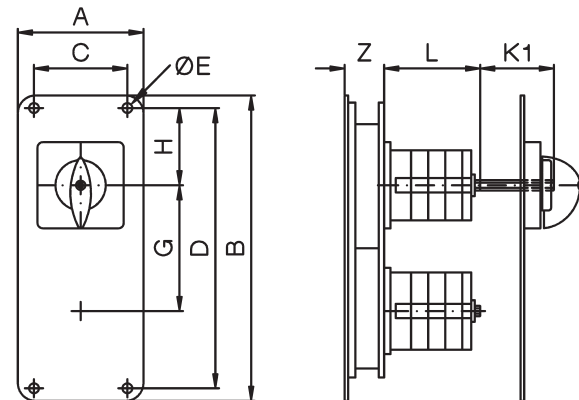

Type	A	B	C	D	E	G	H	Z
M10H, M20	70	170	52	156	5,5	70	43	22
N20, N33F	70	170	52	156	5,5	70	43	22
N40, N61, N80, L100, L160	170	190	150	168	6,5	100	43	23
N100, N200, L400, L600, L800, L1200	180	340	150	310	6,5	140	80	25

Further dimensions see pages 262 and 263

Geared switch with three columns ZK3
Panel mounting E

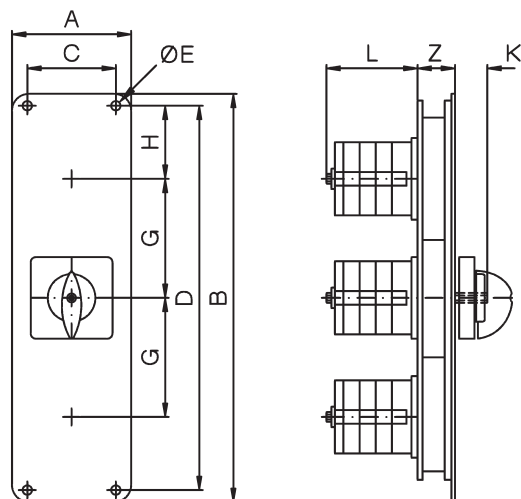

Base mounting V

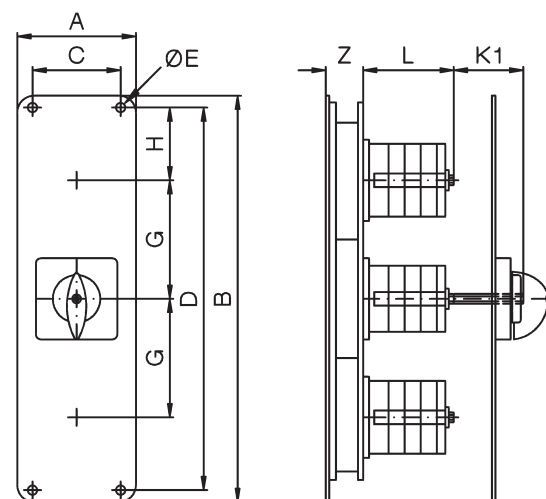

Type	A	B	C	D	E	G	H	Z
M10H, M20	70	240	52	226	5,5	70	43	22
N20, N33F	70	240	52	226	5,5	70	43	22
N40, N61, N80, L100, L160	170	290	150	269	6,5	100	43	23
N100, N200, L400, L600, L800, L1200	180	490	150	460	6,5	140	80	25

Further dimensions see pages 262 and 263

Neon safety switch N20 E .. +FEU, N33F E .. +FEU

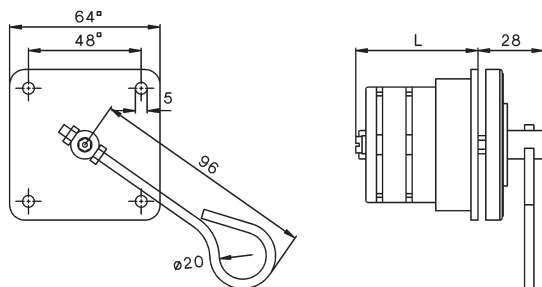

Further dimensions see pages 262

Order sheet D399E

Switch Type
M4H
M10
M10H
M20
N20
N33F L100
N40 L160
N61 L400
N80 L600
N100 L800
N200 L1200

Cam switches with special switching program

Benedict GmbH

A-1220, Vienna, Liebigasse 7
Tel.: 251 51-0 Fax: 251 51-88

Customer:

Explanations:

Contact closed over
several positions
Spring return from pos.



Handles

Instrument knob	G (standard)
Twist knob	R (standard N40 ->)
Toggle knob	K (standard SMA)
Ball type handle	B
Hand wheel	HR

Handle colour

black (standard)
red
grey (standard SMA)
white
cream-coloured
yellow
blue

Connect.

Terminals

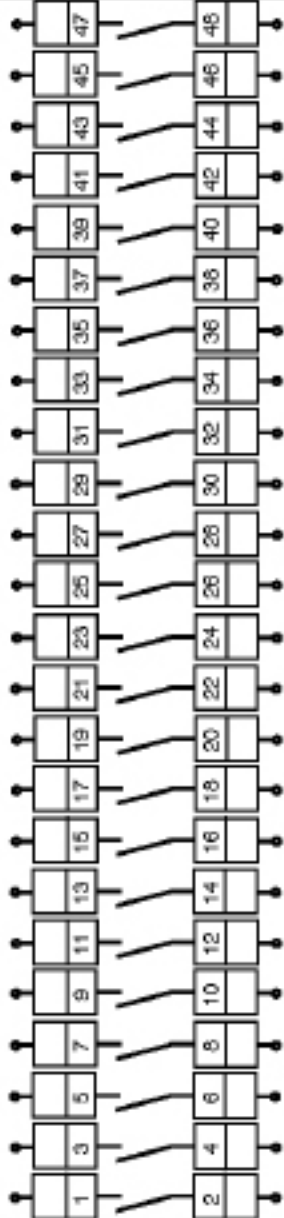

Terminals

Connect.

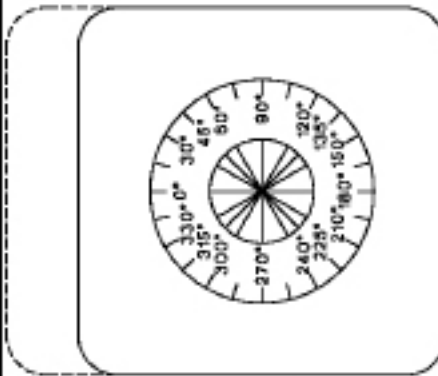

Degree

Marking for switch positions

Optional extras

Circular switch

Key removeable

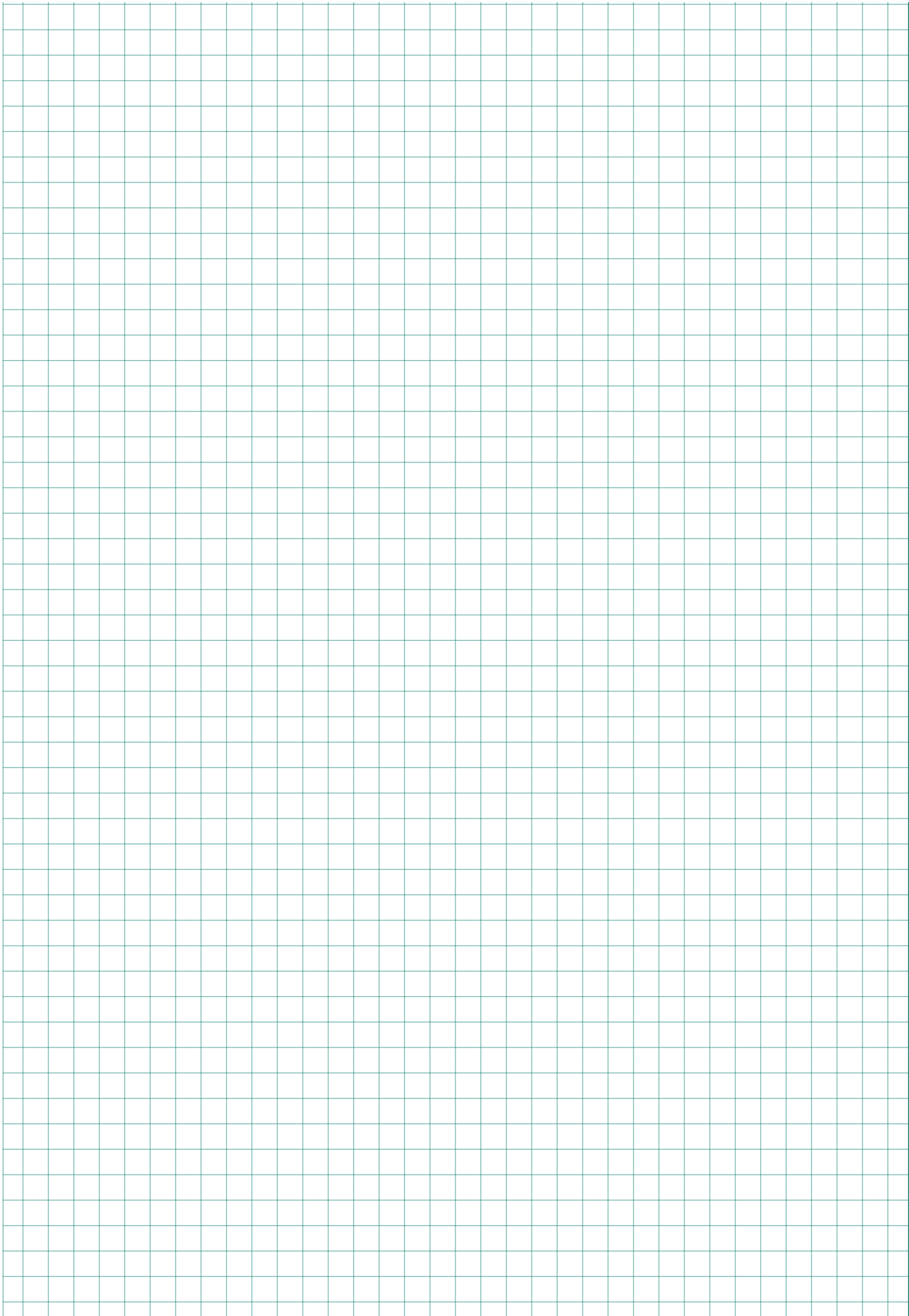

Index

Page



Main Switches for Panel Mounting
Main Switches-Emergency-Stop for Single Hole Mounting

280
281



Main Switches for Base Mounting with Door Clutch

282



Main Switches-Emergency-Stop for Panel Mounting
Main Switches-Emergency-Stop for Single Hole Mounting

286
287



Main Switches-Emergency-Stop for Base Mounting
with Door Clutch

288



Main Switches-Emergency-Stop for Distribution Boards

290



Maintenance and Safety Switches, in Plastic Enclosure

291



Switch Disconnectors for Panel Mounting

292



Switch Disconnectors for Single Hole Mounting

293



Switch Disconnectors for Base Mounting

293



Switch Disconnectors for Distribution Boards

295



Switch Disconnectors in Plastic Enclosure

296



Add-on modules

297



Technical Data

299



Dimensions

300

Contactors, Motor-Starter

Circuit Breakers

Manual Motor-Starters

Switches

AC-Main Switches

DC-Switch Disconnector

Push Buttons

Representatives, Suppliers

Ratings								Protection degree from front in mounted position	Panel mounting 4 hole mount. IP66	Single hole mount. Ø22,5mm IP66				
Type	Rated current Therm.			Motor			Plate Switch	EH4	EHN4	EHN1	Z	ZHN1	ZH1	
	I _{th} open A	AC21 A	at U _e V	AC3 3~400V kW	AC23 3~400V kW									mm
LTS20	20	20	690	5,5	16	7,5	48 [□]						LTS20 E ¹⁾ ..	LTS20 Z ¹⁾ ..
LTS25	25	25	690	7,5	20	10	48 [□]						LTS25 E ¹⁾ ..	LTS25 Z ¹⁾ ..
LTS32	32	32	690	11	25	12,5	48 [□]						LTS32 E ¹⁾ ..	LTS32 Z ¹⁾ ..
LTS40	40	40	690	15	32	16	48 [□]						LTS40 E ¹⁾ ..	LTS40 Z ¹⁾ ..
LTS63	63	63	690	18,5	45	22	48 [□]						LTS63 E ¹⁾ ..	-
LTS80	80	80	690	18,5	45	22	48 [□]						LTS80 E ¹⁾ ..	-
LTS85	85	85	690	22	60	30	64 [□]						LTS85 E ¹⁾ ..	-
LTS100	100	100	690	30	72	37	64 [□]						LTS100 E ¹⁾ ..	-
LTS125	125	125	690	37	85	45	64 [□]						LTS125 E ¹⁾ ..	-
LT160	160	160	690	45	110	55	88 [□]						LT160 E ¹⁾ ..	-

Switch disconnecter LT.. 20 - 160A

Switch disconnectors are to be used as an ON-OFF-switch where a high breaking capacity with high contact pressure and in fact better short circuit behavior is necessary. These applications are:

Main switches according to IEC/EN 60204 respectively VDE0113 with interlocking device, terminal protection and restrictive contacts.

Switch disconnectors according to IEC/EN 60947-3 and VDE 0660 part 107 with break distance for 690V.

Motor switches 3-pole or 4-pole; according to IEC/EN 60947-3 respectively VDE 0660 part 107, motor switches series LT are dimensioned for switching high rated current AC3 and AC23A.

Switch program

On-Off Switch 3-pole	A3
On-Off Switch 4-pole	A4
On-Off Switch 6-pole	A6
On-Off Switch 8-pole	A8
Changeover Switches 3-pole	U3
Changeover Switches 4-pole	U4
On-Off Switch 3-pole	T300 (for LT160)
On-Off Switch 4-pole	T400 (for LT160)

Main switches and Main switches with Emergency-Stop function

According to standards IEC/EN60204 or VDE0113, all electrical equipment of industrial machines must be equipped with a main switch. This must permit disconnection of all the electrical equipment during cleaning, maintenance and repair work, and other extended periods when it is stationary. In case of two or more main switches, an interlock system must be used. It is recommended to use a multiple-pole main switch (cam switch).

Main switches have to correspond to:

- Switch disconnecter according to IEC/EN 60947-3 and VDE 0660 part 107 for utilization category AC23-B or DC-23B.
- Disconnectors are selected according to thermal rated current. They must possess a contact that ensures load switching via the contactors (see switching program A3-10). This contact must have a sufficient AC15 switching capacity.
- The interruption capacity of the switch must equal or exceed the locked rotor current of the largest motor plus the total current of all other electrical equipment in the circuit.

Requirements:

Interruption of the electrical equipment, with only on and off positions clearly marked with O and I.

It must be lockable in the off setting.

The line terminals of the main switch must be protected according to utilization category IP2X.

Colour of handle black or grey.

Main switches with Emergency-Off function are additional supplied with red handles and contrasting yellow escutcheon plates.

1) Main Switches (H1/H4 Main Switches-Emergency-Stop (HN1/HN4))
Switch Disconnectors (without H(N)1/4)

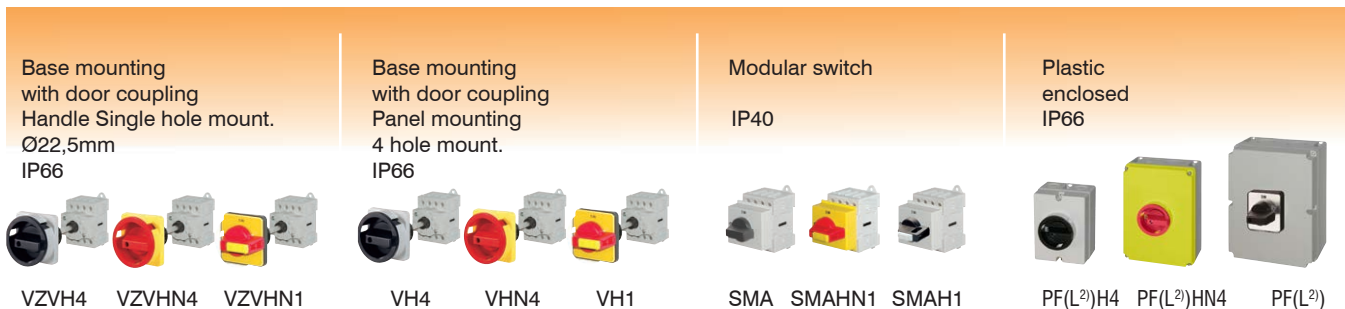

Base mounting with door coupling Handle Single hole mount. Ø22,5mm IP66	Base mounting with door coupling Panel mounting 4 hole mount. IP66	Modular switch IP40	Plastic enclosed IP66
VZVH4 VZVHN4 VZVHN1	VH4 VHN4 VH1	SMA SMAHN1 SMAH1	PF(L ²)H4 PF(L ²)HN4 PF(L ²)
LTS20 VZV ¹⁾ ..	LTS20 V ¹⁾ ..	LTS20 SMA ¹⁾ ..	LTS20 PF(L ²) ¹⁾ ..
LTS25 VZV ¹⁾ ..	LTS25 V ¹⁾ ..	LTS25 SMA ¹⁾ ..	LTS25 PF(L ²) ¹⁾ ..
LTS32 VZV ¹⁾ ..	LTS32 V ¹⁾ ..	LTS32 SMA ¹⁾ ..	LTS32 PF(L ²) ¹⁾ ..
LTS40 VZV ¹⁾ ..	LTS40 V ¹⁾ ..	LTS40 SMA ¹⁾ ..	LTS40 PF(L ²) ¹⁾ ..
LTS63 VZV ¹⁾ ..	LTS63 V ¹⁾ ..	LTS63 SMA ¹⁾ ..	LTS63 PFL ¹⁾ ..
LTS80 VZV ¹⁾ ..	LTS80 V ¹⁾ ..	LTS80 SMA ¹⁾ ..	LTS80 PFL ¹⁾ ..
LTS85 VZV ¹⁾ ..	LTS85 V ¹⁾ ..	LTS85 SMA ¹⁾ ..	LTS85 PFL ¹⁾ ..
LTS100 VZV ¹⁾ ..	LTS100 V ¹⁾ ..	LTS100 SMA ¹⁾ ..	LTS100 PFL ¹⁾ ..
LTS125 VZV ¹⁾ ..	LTS125 V ¹⁾ ..	LTS125 SMA ¹⁾ ..	LTS125 PFL ¹⁾ ..
-	LT160 V ¹⁾ ..	-	LT160 PF ¹⁾ .. ³⁾

Approvals

Area	USA, Canada / UL	Europe	Russia / EAC	CB/CCA-Certificates
Type				

Switch disconnecter (UL-Listed as MANUAL MOTOR CONTROLLER and suitable as MOTOR DISCONNECT)

LTS20	o	o	o	o	
LTS25	o	o	o	o	
LTS32	o	o	o	o	
LTS40	o	o	o	o	
LTS63	o	o	o	o	
LTS80	o	o	o	o	
LTS85	o	o	-	-	
LTS100	o	o	-	-	
LTS125	o	o	-	-	
LT160	o	o	-	o	

o in standard version approved
/ No testing required CE
x in test
- Not provided for test till now

Terminal screws

Devices Type	Kind of connection		Tightening torque		Protection class of terminals ⁴⁾
	screw with clamp box	Screwdriver	Nm	lb. inch	
Switch Disconnectors LTS20, LTS25 LTS32, LTS40 LTS63, LTS80 LTS85, LTS100, LTS125	 M3,5 M5 M6	 Pz2 Pz2 Pz3	1,7 - 2,3 2,8 - 4 1,7 - 4,5	15 - 20 25 - 35 15 - 40	IP20 IP20 IP20 IP20
LT160	M10		14	124	IP20









1) Main Switches (H1/H4 Main Switches-Emergency-Stop (HN1/HN4))
Switch Disconnectors (without H(N)1/4)

2) PFL... larger enclosure

3) IP... Type..

4) Protection degree of the terminals with connected insulated conductor. Additional protection with terminal cover (KLAD).

Main Switches for Panel Mounting, lockable IP66, c(UL)us Type 3R

	max. padlocks	AC21 690V	AC23 3x400V	Plate	Type	Pack pcs.	Weight kg/pcs.
3-pole, padlock device SV1 							
		20A	7,5kW	48 □ ¹⁾	LTS20 EH1 A3	1	0,15
		25A	10kW	48 □ ¹⁾	LTS25 EH1 A3	1	0,15
		32A	12,5kW	48 □ ¹⁾	LTS32 EH1 A3	1	0,15
		40A	16kW	48 □ ¹⁾	LTS40 EH1 A3	1	0,15
		63A	22kW	48 □ ¹⁾	LTS63 EH1 A3	1	0,17
		80A	22kW	48 □ ¹⁾	LTS80 EH1 A3	1	0,17
4-pole, padlock device SV1 							
		20A	7,5kW	48 □ ¹⁾	LTS20 EH1 A4	1	0,19
		25A	10kW	48 □ ¹⁾	LTS25 EH1 A4	1	0,19
		32A	12,5kW	48 □ ¹⁾	LTS32 EH1 A4	1	0,19
		40A	16kW	48 □ ¹⁾	LTS40 EH1 A4	1	0,19
		63A	22kW	48 □ ¹⁾	LTS63 EH1 A4	1	0,21
		80A	22kW	48 □ ¹⁾	LTS80 EH1 A4	1	0,21
3-pole, padlock device SV4(34) 							
		20A	7,5kW	64 □ ²⁾	LTS20 EH4 A3	1	0,17
		25A	10kW	64 □ ²⁾	LTS25 EH4 A3	1	0,17
		32A	12,5kW	64 □ ²⁾	LTS32 EH4 A3	1	0,17
		40A	16kW	64 □ ²⁾	LTS40 EH4 A3	1	0,17
		63A	22kW	64 □ ²⁾	LTS63 EH4 A3	1	0,19
		80A	22kW	64 □ ²⁾	LTS80 EH4 A3	1	0,19
		80A	30kW	64 □ ²⁾	LTS85 EH4 A3	1	0,39
		100A	37kW	64 □ ²⁾	LTS100 EH4 A3	1	0,39
		125A	45kW	64 □ ²⁾	LTS125 EH4 A3	1	0,39
		160A	55kW	88 □	LT160 EH34 T300	1	1,16
4-pole, padlock device SV4(34) 							
		20A	7,5kW	64 □ ²⁾	LTS20 EH4 A4	1	0,20
		25A	10kW	64 □ ²⁾	LTS25 EH4 A4	1	0,20
		32A	12,5kW	64 □ ²⁾	LTS32 EH4 A4	1	0,20
		40A	16kW	64 □ ²⁾	LTS40 EH4 A4	1	0,20
		63A	22kW	64 □ ²⁾	LTS63 EH4 A4	1	0,23
		80A	22kW	64 □ ²⁾	LTS80 EH4 A4	1	0,23
		80A	30kW	64 □ ²⁾	LTS85 EH4 A4	1	0,44
		100A	37kW	64 □ ²⁾	LTS100 EH4 A4	1	0,44
		125A	45kW	64 □ ²⁾	LTS125 EH4 A4	1	0,44
		160A	55kW	88 □	LT160 EH34 T400	1	1,55

Add-on modules see page 297



Extended Switch Shaft for switches for panel mounting type suffix +VW“x“

x = panel thickness

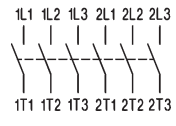

1) Types with padlock device 64 □ type suffix **64**, ordering example: LTS32 EH1**64** A3, on request

2) Types with padlock device 88 □ type suffix **88**, ordering example: LTS32 EH4**88** A3, on request

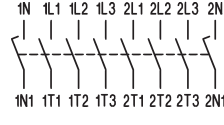

Main Switches for Panel Mounting, lockable IP66, cUL_{us} Type 3R

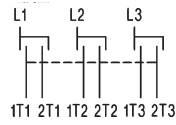
	max. padlocks	AC21 690V	AC23 3x400V	Plate	Type	Pack pcs.	Weight kg/pcs.
6-pole, padlock device SV4 							
		20A	7,5kW	64 □	LTS20 EH4 A6	1	0,30
		25A	10kW	64 □	LTS25 EH4 A6	1	0,30
		32A	12,5kW	64 □	LTS32 EH4 A6	1	0,30
		40A	16kW	64 □	LTS40 EH4 A6	1	0,30
		63A	22kW	64 □	LTS63 EH4 A6	1	0,34
		80A	22kW	64 □	LTS80 EH4 A6	1	0,34
8-pole, padlock device SV4 							
		20A	7,5kW	64 □	LTS20 EH4 A8	1	0,38
		25A	10kW	64 □	LTS25 EH4 A8	1	0,38
		32A	12,5kW	64 □	LTS32 EH4 A8	1	0,38
		40A	16kW	64 □	LTS40 EH4 A8	1	0,38
		63A	22kW	64 □	LTS63 EH4 A8	1	0,42
		80A	22kW	64 □	LTS80 EH4 A8	1	0,42

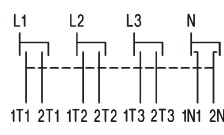
Changeover Switches with padlockdevice for Panel Mounting, lockable IP66

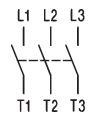

3-pole, padlock device SV4 							
		20A	7,5kW	64 □	LTS20 EH4 U3	1	0,30
		25A	10kW	64 □	LTS25 EH4 U3	1	0,30
		32A	12,5kW	64 □	LTS32 EH4 U3	1	0,30
		40A	16kW	64 □	LTS40 EH4 U3	1	0,30
		63A	22kW	64 □	LTS63 EH4 U3	1	0,34
4-pole, padlock device SV4 							
		20A	7,5kW	64 □	LTS20 EH4 U4	1	0,38
		25A	10kW	64 □	LTS25 EH4 U4	1	0,38
		32A	12,5kW	64 □	LTS32 EH4 U4	1	0,38
		40A	16kW	64 □	LTS40 EH4 U4	1	0,38
		63A	22kW	64 □	LTS63 EH4 U4	1	0,42

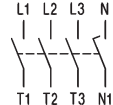
Main Switches for Single Hole Mounting IP66, cUL_{us} Type 4X

	max. padlocks	AC21 690V	AC23 3x400V	Plate	Type	Pack pcs.	Weight kg/pcs.
3-pole, padlock device SV1 							
		20A	7,5kW	48 □	LTS20 ZH1 A3	1	0,16
		25A	10kW	48 □	LTS25 ZH1 A3	1	0,16
		32A	12,5kW	48 □	LTS32 ZH1 A3	1	0,16
		40A	16kW	48 □	LTS40 ZH1 A3	1	0,16
4-pole, padlock device SV1 							
		20A	7,5kW	48 □	LTS20 ZH1 A4	1	0,20
		25A	10kW	48 □	LTS25 ZH1 A4	1	0,20
		32A	12,5kW	48 □	LTS32 ZH1 A4	1	0,20
		40A	16kW	48 □	LTS40 ZH1 A4	1	0,20

Add-on modules see page 297

Main Switches, Base Mounting with Door Clutch for Single-Hole Mounting
 Depth X is adjustable (delivered with X_{max} see below), IP66,  Type 4X

	max. padlocks	AC21 690V	AC23 3x400V	Plate	Type	Pack pcs.	Weight kg/pcs.
3-pole, padlock device SV4 							
		20A	7,5kW	64 □	LTS20 VZVH4 A3	1	0,19
		25A	10kW	64 □	LTS25 VZVH4 A3	1	0,19
		32A	12,5kW	64 □	LTS32 VZVH4 A3	1	0,19
		40A	16kW	64 □	LTS40 VZVH4 A3	1	0,19
		63A	22kW	64 □	LTS63 VZVH4 A3	1	0,22
		80A	22kW	64 □	LTS80 VZVH4 A3	1	0,22
		85A	30kW	64 □	LTS85 VZVH4 A3	1	0,40
		100A	37kW	64 □	LTS100 VZVH4 A3	1	0,40
		125A	45kW	64 □	LTS125 VZVH4 A3	1	0,40
4-pole, padlock device SV4 							
		20A	7,5kW	64 □	LTS20 VZVH4 A4	1	0,20
		25A	10kW	64 □	LTS25 VZVH4 A4	1	0,20
		32A	12,5kW	64 □	LTS32 VZVH4 A4	1	0,20
		40A	16kW	64 □	LTS40 VZVH4 A4	1	0,20
		63A	22kW	64 □	LTS63 VZVH4 A4	1	0,26
		80A	22kW	64 □	LTS80 VZVH4 A4	1	0,26
		85A	30kW	64 □	LTS85 VZVH4 A4	1	0,45
		100A	37kW	64 □	LTS100 VZVH4 A4	1	0,45
		125A	45kW	64 □	LTS125 VZVH4 A4	1	0,45
6-pole, padlock device SV4 							
		20A	7,5kW	64 □	LTS20 VZVH4 A6	1	0,32
		25A	10kW	64 □	LTS25 VZVH4 A6	1	0,32
		32A	12,5kW	64 □	LTS32 VZVH4 A6	1	0,32
		40A	16kW	64 □	LTS40 VZVH4 A6	1	0,32
		63A	22kW	64 □	LTS63 VZVH4 A6	1	0,37
		80A	22kW	64 □	LTS80 VZVH4 A6	1	0,37
8-pole, padlock device SV4 							
		20A	7,5kW	64 □	LTS20 VZVH4 A8	1	0,34
		25A	10kW	64 □	LTS25 VZVH4 A8	1	0,34
		32A	12,5kW	64 □	LTS32 VZVH4 A8	1	0,34
		40A	16kW	64 □	LTS40 VZVH4 A8	1	0,34
		63A	22kW	64 □	LTS63 VZVH4 A8	1	0,45
		80A	22kW	64 □	LTS80 VZVH4 A8	1	0,45

Depth
 Single Hole Mounting Ø22mm
 LTS.. VZV..

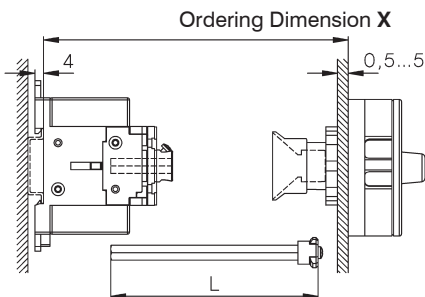

Type		X min	X max	L
LTS20-80 VZV..	3, 4-pole	91	190	X - 40±3
LTS20-80 VZV..	6, 8-pole	111	190	X - 60±3
LTS85-125 VZV..	3, 4-pole	95	190	X - 44±3

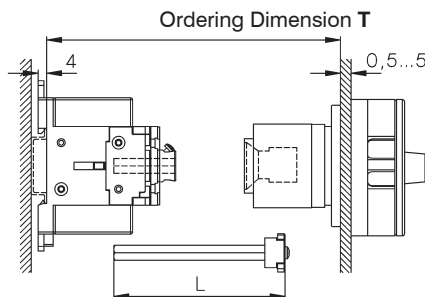

4-Hole Mounting
 LTS.. V(H).. (3, 4-pole)



Type		T min	T max	L	Type	T min	T max
LTS20-80 VH..		111	190	T - 60±3	LT160 VH..	120	450
LTS85-125 VH..		115	190	T - 64±3			

greater X- and T-Dimensions (max. 380mm for LTS..) on request

Main Switches, Base Mounting with Door Clutch, Padlock Device for 4-Hole Mounting
 Depth T is adjustable (delivered with T_{max} see page 271), IP66, cUL_{us} Type 4X

	max. padlocks	AC21 690V	AC23 3x400V	Plate	Type	Pack pcs.	Weight kg/pcs.
3-pole, padlock device SV4(34)  							
		20A	7,5kW	64 □ ¹⁾	LTS20 VH4 A3	1	0,20
		25A	10kW	64 □ ¹⁾	LTS25 VH4 A3	1	0,20
		32A	12,5kW	64 □ ¹⁾	LTS32 VH4 A3	1	0,20
		40A	16kW	64 □ ¹⁾	LTS40 VH4 A3	1	0,20
		63A	22kW	64 □ ¹⁾	LTS63 VH4 A3	1	0,24
		80A	22kW	64 □ ¹⁾	LTS80 VH4 A3	1	0,24
		85A	30kW	64 □ ¹⁾	LTS85 VH4 A3	1	0,40
		100A	37kW	64 □ ¹⁾	LTS100 VH4 A3	1	0,40
		125A	45kW	64 □ ¹⁾	LTS125 VH4 A3	1	0,40
		160A	55kW	88 □	LT160 VH34 T300	1	1,38

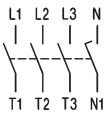
4-pole, padlock device SV4(34)  							
		20A	7,5kW	64 □ ¹⁾	LTS20 VH4 A4	1	0,21
		25A	10kW	64 □ ¹⁾	LTS25 VH4 A4	1	0,21
		32A	12,5kW	64 □ ¹⁾	LTS32 VH4 A4	1	0,21
		40A	16kW	64 □ ¹⁾	LTS40 VH4 A4	1	0,21
		63A	22kW	64 □ ¹⁾	LTS63 VH4 A4	1	0,28
		80A	22kW	64 □ ¹⁾	LTS80 VH4 A4	1	0,28
		85A	30kW	64 □ ¹⁾	LTS85 VH4 A4	1	0,45
		100A	37kW	64 □ ¹⁾	LTS100 VH4 A4	1	0,45
		125A	45kW	64 □ ¹⁾	LTS125 VH4 A4	1	0,45
		160A	55kW	88 □	LT160 VH34 T400	1	1,77

Emergency-Stop-Main Switches, Base Mounting with Door Clutch for Single-Hole Mounting
 Depth X is not adjustable, declare depth X when ordering, IP66, cUL_{us} Type 4X

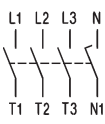
4-pole, padlock device SV4  							
		20A	7,5kW	64 □	LTS20 VZH4 A4 X..	1	0,18
		25A	10kW	64 □	LTS25 VZH4 A4 X..	1	0,18
		32A	12,5kW	64 □	LTS32 VZH4 A4 X..	1	0,18
		40A	16kW	64 □	LTS40 VZH4 A4 X..	1	0,18
		63A	22kW	64 □	LTS63 VZH4 A4 X..	1	0,25
		80A	22kW	64 □	LTS80 VZH4 A4 X..	1	0,25

Declare depth X when ordering

Type	Preference values for X
LT.. VZH..	80, 85, 104, 129 (tolerance -3, +1,5)

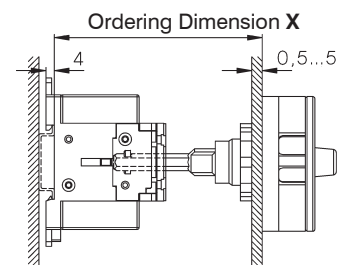

Add-on modules see page 297

1) Types with padlock device 88 'type suffix **88**, ordering example: LTS32 VHN**488** A3, on request

Main Switches for Distribution Boards, lockable IP40, Open Type

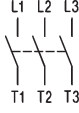
		max. padlocks	AC21 690V	AC23 3x400V	Plate	Type	Pack pcs.	Weight kg/pcs.
3-pole, padlock device SV1  								
			20A	7,5kW	52x45	LTS20 SMAH1 A3 ²⁾	1	0,15
			25A	10kW	52x45	LTS25 SMAH1 A3 ²⁾	1	0,15
			32A	12,5kW	52x45	LTS32 SMAH1 A3 ²⁾	1	0,15
			40A	16kW	52x45	LTS40 SMAH1 A3 ²⁾	1	0,15
			63A	22kW	52x45	LTS63 SMAH1 A3 ²⁾	1	0,18
			80A	22kW	52x45	LTS80 SMAH1 A3 ²⁾	1	0,18
			85A	30kW	78x45	LTS85 SMAH1 A3	1	0,37
		100A	37kW	78x45	LTS100 SMAH1 A3	1	0,37	
		125A	45kW	78x45	LTS125 SMAH1 A3	1	0,37	

4-pole, padlock device SV1  								
			20A	7,5kW	52x45	LTS20 SMAH1 A4 ²⁾	1	0,16
			25A	10kW	52x45	LTS25 SMAH1 A4 ²⁾	1	0,16
			32A	12,5kW	52x45	LTS32 SMAH1 A4 ²⁾	1	0,16
			40A	16kW	52x45	LTS40 SMAH1 A4 ²⁾	1	0,16
			63A	22kW	52x45	LTS63 SMAH1 A4 ²⁾	1	0,21
			80A	22kW	52x45	LTS80 SMAH1 A4 ²⁾	1	0,21
			85A	30kW	78x45	LTS85 SMAH1 A4	1	0,42
		100A	37kW	78x45	LTS100 SMAH1 A4	1	0,42	
		125A	45kW	78x45	LTS125 SMAH1 A4	1	0,42	

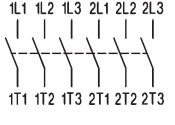
6-pole, padlock device SV1 (64)  								
			20A	7,5kW	52x45	LTS20 SMAH1 A6	1	0,29
			25A	10kW	52x45	LTS25 SMAH1 A6	1	0,29
			32A	12,5kW	52x45	LTS32 SMAH1 A6	1	0,29
			40A	16kW	52x45	LTS40 SMAH1 A6	1	0,29
			63A	22kW	97x45	LTS63 SMAH1 A6 ¹⁾	1	0,34
		80A	22kW	97x45	LTS80 SMAH1 A6 ¹⁾	1	0,34	

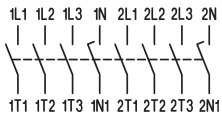
8-pole, padlock device SV164  								
			20A	7,5kW	97x45	LTS20 SMAH1 A8	1	0,31
			25A	10kW	97x45	LTS25 SMAH1 A8	1	0,31
			32A	12,5kW	97x45	LTS32 SMAH1 A8	1	0,31
			40A	16kW	97x45	LTS40 SMAH1 A8	1	0,31
			63A	22kW	126x45	LTS63 SMAH1 A8	1	0,42
		80A	22kW	126x45	LTS80 SMAH1 A8	1	0,42	

Changeover Switch with Padlock Device for Distribution Boards, lockable

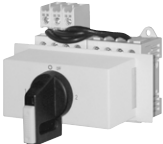
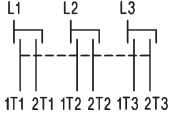

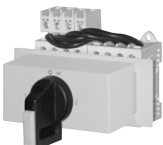
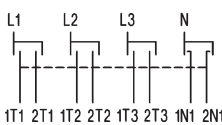









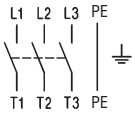













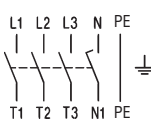













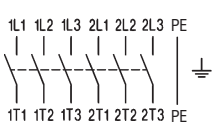









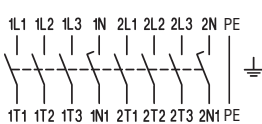









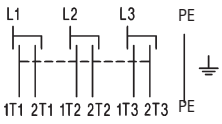





3-pole, padlock device SV164  								
			20A	7,5kW	97x45	LTS20 SMAH1 U3	1	0,29
			25A	10kW	97x45	LTS25 SMAH1 U3	1	0,29
			32A	12,5kW	97x45	LTS32 SMAH1 U3	1	0,29
			40A	16kW	97x45	LTS40 SMAH1 U3	1	0,29
		63A	22kW	97x45	LTS63 SMAH1 U3	1	0,34	

4-pole, padlock device SV164  								
			20A	7,5kW	97x45	LTS20 SMAH1 U4	1	0,31
			25A	10kW	97x45	LTS25 SMAH1 U4	1	0,31
			32A	12,5kW	97x45	LTS32 SMAH1 U4	1	0,31
			40A	16kW	97x45	LTS40 SMAH1 U4	1	0,31
		63A	22kW	126x45	LTS63 SMAH1 U4	1	0,42	

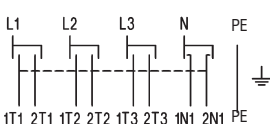
1) With padlock device SV164









2) Emergency-Stop-Main Switches for Distribution Boards, lockable with low height handle, IP40
 Type with Type-suffix „+SV1N“ e.g.: **LTS40 SMAHN1 A3 +SV1N**

Maintenance and Safety Switches, in Plastic Enclosure, lockable IP66, Type 4X

	max. padlocks	AC21 690V	AC23 3x400V	Plate	Type	Pack pcs.	Weight kg/pcs.	
3-pole, padlock device SV4(34)  								
 		20A	7,5kW	64 	LTS20 PF(L ¹)H4 A3	1	0,32	
		25A	10kW	64 	LTS25 PF(L ¹)H4 A3	1	0,32	
		32A	12,5kW	64 	LTS32 PF(L ¹)H4 A3	1	0,32	
		40A	16kW	64 	LTS40 PF(L ¹)H4 A3	1	0,32	
		63A	22kW	64 	LTS63 PFLH4 A3	1	0,60	
		80A	22kW	64 	LTS80 PFLH4 A3	1	0,60	
	Larger enclosure		85A	30kW	64 	LTS85 PFLH4 A3	1	0,78
	Type: ..PFL..	on request	100A	37kW	64 	LTS100 PFLH4 A3	1	0,78
		125A	45kW	64 	LTS125 PFLH4 A3	1	0,78	
		160A	55kW	88 	LT160 PFH34 T300	1	2,09	
4-pole, padlock device SV4(34)  								
 		20A	7,5kW	64 	LTS20 PF(L ¹)H4 A4	1	0,33	
		25A	10kW	64 	LTS25 PF(L ¹)H4 A4	1	0,33	
		32A	12,5kW	64 	LTS32 PF(L ¹)H4 A4	1	0,33	
		40A	16kW	64 	LTS40 PF(L ¹)H4 A4	1	0,33	
		63A	22kW	64 	LTS63 PFLH4 A4	1	0,64	
		80A	22kW	64 	LTS80 PFLH4 A4	1	0,64	
	Larger enclosure		85A	30kW	64 	LTS85 PFLH4 A4	1	0,83
	Type appendix +PF3	on request	100A	37kW	64 	LTS100 PFLH4 A4	1	0,83
+PF3/M50	on request	125A	45kW	64 	LTS125 PFLH4 A4	1	0,83	
		160A	55kW	88 	LT160 PFH34 T400	1	2,47	
6-pole, padlock device SV4  								
 		20A	7,5kW	64 	LTS20 PFLH4 A6	1	1,39	
		25A	10kW	64 	LTS25 PFLH4 A6	1	1,39	
		32A	12,5kW	64 	LTS32 PFLH4 A6	1	1,39	
		40A	16kW	64 	LTS40 PFLH4 A6	1	1,39	
		63A	22kW	64 	LTS63 PFLH4 A6	1	1,42	
		80A	22kW	64 	LTS80 PFLH4 A6	1	1,42	
	knockoutlets M50/40							
	+PF3/M50	on request						
8-pole, padlock device SV4  								
 		20A	7,5kW	64 	LTS20 PFLH4 A8	1	1,44	
		25A	10kW	64 	LTS25 PFLH4 A8	1	1,44	
		32A	12,5kW	64 	LTS32 PFLH4 A8	1	1,44	
		40A	16kW	64 	LTS40 PFLH4 A8	1	1,44	
		63A	22kW	64 	LTS63 PFLH4 A8	1	1,50	
		80A	22kW	64 	LTS80 PFLH4 A8	1	1,50	
	knockoutlets M50/40							
	+PF3/M50	on request						
Changeover Switch with Padlock Device, lockable								
3-pole, padlock device SV4  								
 		20A	7,5kW	64 	LTS20 PFLH4 U3	1	1,39	
		25A	10kW	64 	LTS25 PFLH4 U3	1	1,39	
		32A	12,5kW	64 	LTS32 PFLH4 U3	1	1,39	
		40A	16kW	64 	LTS40 PFLH4 U3	1	1,39	
		63A	22kW	64 	LTS63 PFLH4 U3	1	1,42	
		80A	22kW	64 	LTS80 PFLH4 U3	1	1,42	
4-pole, padlock device SV4  								
 		20A	7,5kW	64 	LTS20 PFLH4 U4	1	1,44	
		25A	10kW	64 	LTS25 PFLH4 U4	1	1,44	
		32A	12,5kW	64 	LTS32 PFLH4 U4	1	1,44	
		40A	16kW	64 	LTS40 PFLH4 U4	1	1,44	
		63A	22kW	64 	LTS63 PFLH4 U4	1	1,50	
		80A	22kW	64 	LTS80 PFLH4 U4	1	1,50	

1) PFL.... larger enclosure

Emergency-Stop-Main Switches for Panel Mounting, lockable IP66, Type 3R

	max. padlocks	AC21 690V	AC23 3x400V	Plate	Type	Pack pcs.	Weighth kg/pcs.
3-pole, padlock device SV1 							
		20A	7,5kW	48 ^{□ 1)}	LTS20 EHN1 A3	1	0,15
		25A	10kW	48 ^{□ 1)}	LTS25 EHN1 A3	1	0,15
		32A	12,5kW	48 ^{□ 1)}	LTS32 EHN1 A3	1	0,15
		40A	16kW	48 ^{□ 1)}	LTS40 EHN1 A3	1	0,15
		63A	22kW	48 ^{□ 1)}	LTS63 EHN1 A3	1	0,17
		80A	22kW	48 ^{□ 1)}	LTS80 EHN1 A3	1	0,17
4-pole, padlock device SV1 							
		20A	7,5kW	48 ^{□ 1)}	LTS20 EHN1 A4	1	0,19
		25A	10kW	48 ^{□ 1)}	LTS25 EHN1 A4	1	0,19
		32A	12,5kW	48 ^{□ 1)}	LTS32 EHN1 A4	1	0,19
		40A	16kW	48 ^{□ 1)}	LTS40 EHN1 A4	1	0,19
		63A	22kW	48 ^{□ 1)}	LTS63 EHN1 A4	1	0,21
		80A	22kW	48 ^{□ 1)}	LTS80 EHN1 A4	1	0,21
3-pole, padlock device SV4(34) 							
		20A	7,5kW	64 ^{□ 2)}	LTS20 EHN4 A3	1	0,17
		25A	10kW	64 ^{□ 2)}	LTS25 EHN4 A3	1	0,17
		32A	12,5kW	64 ^{□ 2)}	LTS32 EHN4 A3	1	0,17
		40A	16kW	64 ^{□ 2)}	LTS40 EHN4 A3	1	0,17
		63A	22kW	64 ^{□ 2)}	LTS63 EHN4 A3	1	0,19
		80A	22kW	64 ^{□ 2)}	LTS80 EHN4 A3	1	0,19
		85A	30kW	64 ^{□ 2)}	LTS85 EHN4 A3	1	0,39
		100A	37kW	64 ^{□ 2)}	LTS100 EHN4 A3	1	0,39
		125A	45kW	64 ^{□ 2)}	LTS125 EHN4 A3	1	0,39
		160A	55kW	88 [□]	LT160 EHN34 T300	1	1,16
4-pole, padlock device SV4(34) 							
		20A	7,5kW	64 ^{□ 2)}	LTS20 EHN4 A4	1	0,20
		25A	10kW	64 ^{□ 2)}	LTS25 EHN4 A4	1	0,20
		32A	12,5kW	64 ^{□ 2)}	LTS32 EHN4 A4	1	0,20
		40A	16kW	64 ^{□ 2)}	LTS40 EHN4 A4	1	0,20
		63A	22kW	64 ^{□ 2)}	LTS63 EHN4 A4	1	0,23
		80A	22kW	64 ^{□ 2)}	LTS80 EHN4 A4	1	0,23
		85A	30kW	64 ^{□ 2)}	LTS85 EHN4 A4	1	0,44
		100A	37kW	64 ^{□ 2)}	LTS100 EHN4 A4	1	0,44
		125A	45kW	64 ^{□ 2)}	LTS125 EHN4 A4	1	0,44
		160A	55kW	88 [□]	LT160 EHN34 T400	1	1,55

Add-on modules see page 297

Extended Switch Shaft for switches for panel mounting



type suffix +VW"x"

x = panel thickness

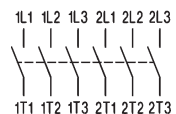

1) Types with padlock device 64 type suffix **64**, ordering example: LTS32 EHN1**64** A3, on request

2) Types with padlock device 88 type suffix **88**, ordering example: LTS32 EHN**88** A3, on request

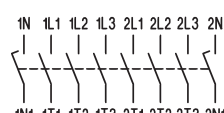

Emergency-Stop-Main Switches for Panel Mounting, lockable IP66, Type 3R

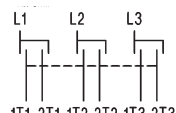
	max. padlocks	AC21 690V	AC23 3x400V	Plate	Type	Pack pcs.	Weight kg/pcs.
6-pole, padlock device SV4 							
		20A	7,5kW	64 □	LTS20 EHN4 A6	1	0,30
		25A	10kW	64 □	LTS25 EHN4 A6	1	0,30
		32A	12,5kW	64 □	LTS32 EHN4 A6	1	0,30
		40A	16kW	64 □	LTS40 EHN4 A6	1	0,30
		63A	22kW	64 □	LTS63 EHN4 A6	1	0,34
		80A	22kW	64 □	LTS80 EHN4 A6	1	0,34
8-pole, padlock device SV4 							
		20A	7,5kW	64 □	LTS20 EHN4 A8	1	0,38
		25A	10kW	64 □	LTS25 EHN4 A8	1	0,38
		32A	12,5kW	64 □	LTS32 EHN4 A8	1	0,38
		40A	16kW	64 □	LTS40 EHN4 A8	1	0,38
		63A	22kW	64 □	LTS63 EHN4 A8	1	0,42
		80A	22kW	64 □	LTS80 EHN4 A8	1	0,42

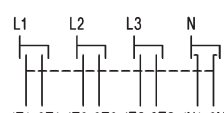
Changeover Switch with Padlock Device for Panel Mounting, lockable IP66

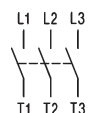

3-pole, padlock device SV4 							
		20A	7,5kW	64 □	LTS20 EHN4 U3	1	0,30
		25A	10kW	64 □	LTS25 EHN4 U3	1	0,30
		32A	12,5kW	64 □	LTS32 EHN4 U3	1	0,30
		40A	16kW	64 □	LTS40 EHN4 U3	1	0,30
		63A	22kW	64 □	LTS63 EHN4 U3	1	0,34
4-pole, padlock device SV4 							
		20A	7,5kW	64 □	LTS20 EHN4 U4	1	0,38
		25A	10kW	64 □	LTS25 EHN4 U4	1	0,38
		32A	12,5kW	64 □	LTS32 EHN4 U4	1	0,38
		40A	16kW	64 □	LTS40 EHN4 U4	1	0,38
		63A	22kW	64 □	LTS63 EHN4 U4	1	0,42

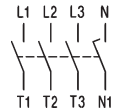
Main Switches Emergency-Stop for Single Hole Mounting, lockable IP66 Type 4X

	max. padlocks	AC21 690V	AC23 3x400V	Plate	Type	Pack pcs.	Weight kg/pcs.
3-pole, padlock device SV1 							
		20A	7,5kW	48 □	LTS20 ZHN1 A3	1	0,16
		25A	10kW	48 □	LTS25 ZHN1 A3	1	0,16
		32A	12,5kW	48 □	LTS32 ZHN1 A3	1	0,16
		40A	16kW	48 □	LTS40 ZHN1 A3	1	0,16
4-pole, padlock device SV1 							
		20A	7,5kW	48 □	LTS20 ZHN1 A4	1	0,20
		25A	10kW	48 □	LTS25 ZHN1 A4	1	0,20
		32A	12,5kW	48 □	LTS32 ZHN1 A4	1	0,20
		40A	16kW	48 □	LTS40 ZHN1 A4	1	0,20

Add-on modules see page 295

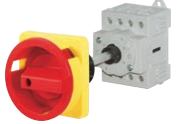
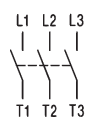
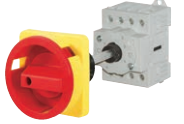
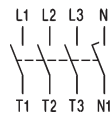
Emergency-Stop-Main Switches, Base Mounting with Door Clutch for Single-Hole Mounting
 Depth X is adjustable (delivered with X_{max} see below), IP66, cUL_{us} Type 4X

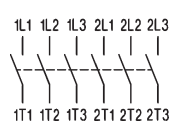
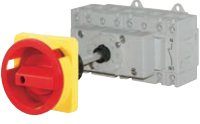
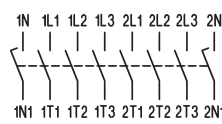
	max. padlocks	AC21 690V	AC23 3x400V	Plate	Type	Pack pcs.	Weight kg/pcs.
3-pole, padlock device SV4							
 	3	20A	7,5kW	64 □	LTS20 VZVHN4 A3	1	0,19
		25A	10kW	64 □	LTS25 VZVHN4 A3	1	0,19
		32A	12,5kW	64 □	LTS32 VZVHN4 A3	1	0,19
		40A	16kW	64 □	LTS40 VZVHN4 A3	1	0,19
		63A	22kW	64 □	LTS63 VZVHN4 A3	1	0,22
		80A	22kW	64 □	LTS80 VZVHN4 A3	1	0,22
		85A	30kW	64 □	LTS85 VZVHN4 A3	1	0,40
		100A	37kW	64 □	LTS100 VZVHN4 A3	1	0,40
		125A	45kW	64 □	LTS125 VZVHN4 A3	1	0,40
	4-pole, padlock device SV4						
 	3	20A	7,5kW	64 □	LTS20 VZVHN4 A4	1	0,20
		25A	10kW	64 □	LTS25 VZVHN4 A4	1	0,20
		32A	12,5kW	64 □	LTS32 VZVHN4 A4	1	0,20
		40A	16kW	64 □	LTS40 VZVHN4 A4	1	0,20
		63A	22kW	64 □	LTS63 VZVHN4 A4	1	0,26
		80A	22kW	64 □	LTS80 VZVHN4 A4	1	0,26
		85A	30kW	64 □	LTS85 VZVHN4 A4	1	0,45
		100A	37kW	64 □	LTS100 VZVHN4 A4	1	0,45
		125A	45kW	64 □	LTS125 VZVHN4 A4	1	0,45
	6-pole, padlock device SV4						
 	3	20A	7,5kW	64 □	LTS20 VZVHN4 A6	1	0,32
		25A	10kW	64 □	LTS25 VZVHN4 A6	1	0,32
		32A	12,5kW	64 □	LTS32 VZVHN4 A6	1	0,32
		40A	16kW	64 □	LTS40 VZVHN4 A6	1	0,32
		63A	22kW	64 □	LTS63 VZVHN4 A6	1	0,37
		80A	22kW	64 □	LTS80 VZVHN4 A6	1	0,37
8-pole, padlock device SV4							
 	3	20A	7,5kW	64 □	LTS20 VZVHN4 A8	1	0,34
		25A	10kW	64 □	LTS25 VZVHN4 A8	1	0,34
		32A	12,5kW	64 □	LTS32 VZVHN4 A8	1	0,34
		40A	16kW	64 □	LTS40 VZVHN4 A8	1	0,34
	63A	22kW	64 □	LTS63 VZVHN4 A8	1	0,45	
	80A	22kW	64 □	LTS80 VZVHN4 A8	1	0,45	

Depth
 Single Hole Mounting Ø22mm
 LTS.. VZV..

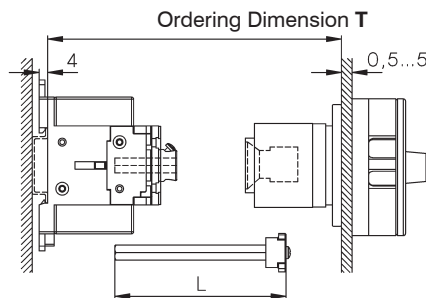
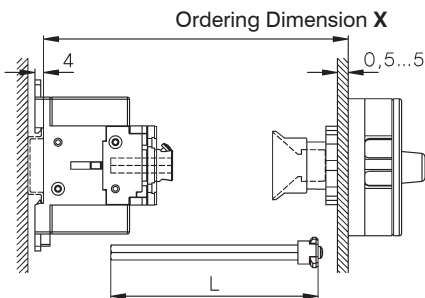

4-Hole Mounting
 LTS.. V(HN).. (3, 4-pole)





Type		X min	X max	L	Type	T min	T max	L	Type	T min	T max
LTS20-80 VZV..	3, 4-polig	91	190	X - 40±3	LTS20-80 VH..	111	190	T - 60±3	LT160 VH..	120	450
LTS20-80 VZV..	6, 8-polig	111	190	X - 60±3	LTS85-125 VH..	115	190	T - 64±3			
LTS85-125 VZV..	3, 4-polig	95	190	X - 44±3							

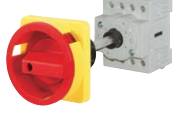
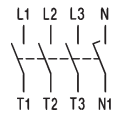

greater X- and T-Dimensions (max. 380mm for LTS..) on request

Emergency-Stop-Main Switches, Base Mounting with Door Clutch, Padlock Device for 4-Hole Mounting, Depth T is adjustable (delivered with T_{max} see page 282), IP66,  Type 4X

	max. padlocks	AC21 690V	AC23 3x400V	Schild	Type	Pack pcs.	Weight kg/pcs.
3-pole, padlock device SV4(34)  		20A	7,5kW	64 ¹⁾	LTS20 VHN4 A3	1	0,20
		25A	10kW	64 ¹⁾	LTS25 VHN4 A3	1	0,20
		32A	12,5kW	64 ¹⁾	LTS32 VHN4 A3	1	0,20
	40A	16kW	64 ¹⁾	LTS40 VHN4 A3	1	0,20	
	63A	22kW	64 ¹⁾	LTS63 VHN4 A3	1	0,24	
	80A	22kW	64 ¹⁾	LTS80 VHN4 A3	1	0,24	
	85A	30kW	64 ¹⁾	LTS85 VHN4 A3	1	0,40	
	100A	37kW	64 ¹⁾	LTS100 VHN4 A3	1	0,40	
	125A	45kW	64 ¹⁾	LTS125 VHN4 A3	1	0,40	
	160A	55kW	88 ¹⁾	LT160 VHN34 T300	1	1,38	

4-pole, padlock device SV4(34)  		20A	7,5kW	64 ¹⁾	LTS20 VHN4 A4	1	0,21
		25A	10kW	64 ¹⁾	LTS25 VHN4 A4	1	0,21
		32A	12,5kW	64 ¹⁾	LTS32 VHN4 A4	1	0,21
	40A	16kW	64 ¹⁾	LTS40 VHN4 A4	1	0,21	
	63A	22kW	64 ¹⁾	LTS63 VHN4 A4	1	0,28	
	80A	22kW	64 ¹⁾	LTS80 VHN4 A4	1	0,28	
	85A	30kW	64 ¹⁾	LTS85 VHN4 A4	1	0,45	
	100A	37kW	64 ¹⁾	LTS100 VHN4 A4	1	0,45	
	125A	45kW	64 ¹⁾	LTS125 VHN4 A4	1	0,45	
	160A	55kW	88 ¹⁾	LT160 VHN34 T400	1	1,77	

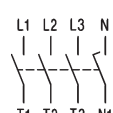
Emergency-Stop-Main Switches, Base Mounting with Door Clutch for Single-Hole Mounting Depth X is not adjustable, declare depth X when ordering, IP66,  Type 4x

4-pole, padlock device SV4  		20A	7,5kW	64 ¹⁾	LTS20 VZHN4 A4 X..	1	0,18
		25A	10kW	64 ¹⁾	LTS25 VZHN4 A4 X..	1	0,18
		32A	12,5kW	64 ¹⁾	LTS32 VZHN4 A4 X..	1	0,18
		40A	16kW	64 ¹⁾	LTS40 VZHN4 A4 X..	1	0,18
		63A	22kW	64 ¹⁾	LTS63 VZHN4 A4 X..	1	0,25
		80A	22kW	64 ¹⁾	LTS80 VZHN4 A4 X..	1	0,25

Declare depth X when ordering

Type	Preference values for X
LTS.. VZH..	80, 85, 104, 129 (tolerance -3, +1,5)

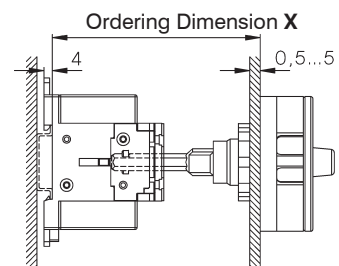

Add-on modules see page 297

1) Types with padlock device 88 ¹⁾ type suffix **88**, ordering example: LTS32 VHN**488** A3, on request

Emergency-Stop-Main Switches for Distribution Boards, lockable IP40, Open Type

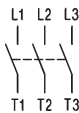
	max. padlocks	AC21 690V	AC23 3x400V	Plate	Type	Pack pcs.	Weight kg/pcs.
3-pole, padlock device SV1 		20A	7,5kW	52x45	LTS20 SMAHN1 A3 ²⁾	1	0,15
		25A	10kW	52x45	LTS25 SMAHN1 A3 ²⁾	1	0,15
		32A	12,5kW	52x45	LTS32 SMAHN1 A3 ²⁾	1	0,15
		40A	16kW	52x45	LTS40 SMAHN1 A3 ²⁾	1	0,15
		63A	22kW	52x45	LTS63 SMAHN1 A3 ²⁾	1	0,18
		80A	22kW	52x45	LTS80 SMAHN1 A3 ²⁾	1	0,18
		85A	30kW	78x45	LTS85 SMAHN1 A3	1	0,37
		100A	37kW	78x45	LTS100 SMAHN1 A3	1	0,37
		125A	45kW	78x45	LTS125 SMAHN1 A3	1	0,37

4-pole, padlock device SV1 		20A	7,5kW	52x45	LTS20 SMAHN1 A4 ²⁾	1	0,16
		25A	10kW	52x45	LTS25 SMAHN1 A4 ²⁾	1	0,16
		32A	12,5kW	52x45	LTS32 SMAHN1 A4 ²⁾	1	0,16
		40A	16kW	52x45	LTS40 SMAHN1 A4 ²⁾	1	0,16
		63A	22kW	52x45	LTS63 SMAHN1 A4 ²⁾	1	0,21
		80A	22kW	52x45	LTS80 SMAHN1 A4 ²⁾	1	0,21
		85A	30kW	78x45	LTS85 SMAHN1 A4	1	0,42
		100A	37kW	78x45	LTS100 SMAHN1 A4	1	0,42
		125A	45kW	78x45	LTS125 SMAHN1 A4	1	0,42

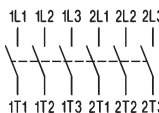
6-pole, padlock device SV1(64) 		20A	7,5kW	52x45	LTS20 SMAHN1 A6	1	0,29
		25A	10kW	52x45	LTS25 SMAHN1 A6	1	0,29
		32A	12,5kW	52x45	LTS32 SMAHN1 A6	1	0,29
		40A	16kW	52x45	LTS40 SMAHN1 A6	1	0,29
		63A	22kW	97x45	LTS63 SMAHN1 A6 ¹⁾	1	0,34
		80A	22kW	97x45	LTS80 SMAHN1 A6 ¹⁾	1	0,34

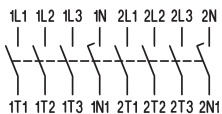
8-pole, padlock device SV164 		20A	7,5kW	97x45	LTS20 SMAHN1 A8	1	0,31
		25A	10kW	97x45	LTS25 SMAHN1 A8	1	0,31
		32A	12,5kW	97x45	LTS32 SMAHN1 A8	1	0,31
		40A	16kW	97x45	LTS40 SMAHN1 A8	1	0,31
		63A	22kW	126x45	LTS63 SMAHN1 A8	1	0,42
		80A	22kW	126x45	LTS80 SMAHN1 A8	1	0,42

Changeover Switch with Padlock Device for Distribution Boards, lockable

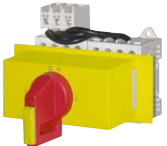
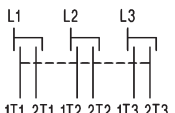

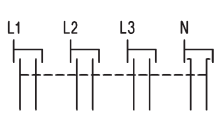









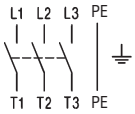









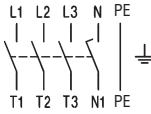











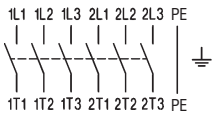







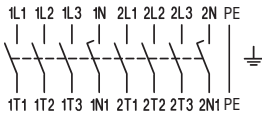







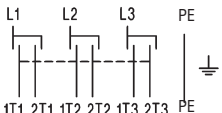



3-pole, padlock device SV164 		20A	7,5kW	97x45	LTS20 SMAHN1 U3	1	0,29
		25A	10kW	97x45	LTS25 SMAHN1 U3	1	0,29
		32A	12,5kW	97x45	LTS32 SMAHN1 U3	1	0,29
		40A	16kW	97x45	LTS40 SMAHN1 U3	1	0,29
		63A	22kW	97x45	LTS63 SMAHN1 U3	1	0,34

4-pole, padlock device SV164 		20A	7,5kW	97x45	LTS20 SMAHN1 U4	1	0,31
		25A	10kW	97x45	LTS25 SMAHN1 U4	1	0,31
		32A	12,5kW	97x45	LTS32 SMAHN1 U4	1	0,31
		40A	16kW	97x45	LTS40 SMAHN1 U4	1	0,31
		63A	22kW	126x45	LTS63 SMAHN1 U4	1	0,42

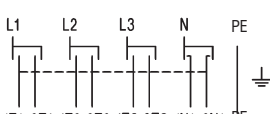
1) With padlock device SV164









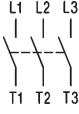

2) Emergency-Stop-Main Switches for Distribution Boards, lockable with low height handle, IP40
 Type with Type-suffix „+SV1N“ e.g.: **LTS40 SMAHN1 A3 +SV1N**

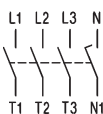
Maintenance and Safety Emergency-Stop-Main Switches, in Plastic Enclosure, lockable IP66,  us Type 4X

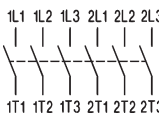

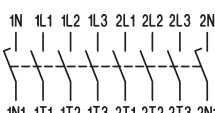
	max. padlocks	AC21 690V	AC23 3x400V	Plate	Type	Pack pcs.	Weight kg/pcs.
3-pole, padlock device SV4(34) 							
		20A	7,5kW	64 	LTS20 PF(L ¹⁾)HN4 A3	1	0,32
		25A	10kW	64 	LTS25 PF(L ¹⁾)HN4 A3	1	0,32
		32A	12,5kW	64 	LTS32 PF(L ¹⁾)HN4 A3	1	0,32
		40A	16kW	64 	LTS40 PF(L ¹⁾)HN4 A3	1	0,32
		63A	22kW	64 	LTS63 PFLHN4 A3	1	0,60
		80A	22kW	64 	LTS80 PFLHN4 A3	1	0,60
		Larger enclosure Type: ..PFL..	on request	125A	45kW	64 	LTS125 PFLHN4 A3
		160A	55kW	88 	LT160 PFHN34 T300	1	2,09
4-pole, padlock device SV4(34) 							
		20A	7,5kW	64 	LTS20 PF(L ¹⁾)HN4 A4	1	0,33
		25A	10kW	64 	LTS25 PF(L ¹⁾)HN4 A4	1	0,33
		32A	12,5kW	64 	LTS32 PF(L ¹⁾)HN4 A4	1	0,33
		40A	16kW	64 	LTS40 PF(L ¹⁾)HN4 A4	1	0,33
		63A	22kW	64 	LTS63 PFLHN4 A4	1	0,64
		80A	22kW	64 	LTS80 PFLHN4 A4	1	0,64
		Larger enclosure Type appendix +PF3	on request	100A	37kW	64 	LTS100 PFLHN4 A4
+PF3/M50	on request	125A	45kW	64 	LTS125 PFLHN4 A4	1	0,83
		160A	55kW	88 	LT160 PFHN34 T400	1	2,47
6-pole, padlock device SV4 							
		20A	7,5kW	64 	LTS20 PFLHN4 A6	1	1,39
		25A	10kW	64 	LTS25 PFLHN4 A6	1	1,39
		32A	12,5kW	64 	LTS32 PFLHN4 A6	1	1,39
		40A	16kW	64 	LTS40 PFLHN4 A6	1	1,39
		63A	22kW	64 	LTS63 PFLHN4 A6	1	1,42
		80A	22kW	64 	LTS80 PFLHN4 A6	1	1,42
		knockoutlets M50/40 +PF3/M50	on request				
8-pole, padlock device SV4 							
		20A	7,5kW	64 	LTS20 PFLHN4 A8	1	1,44
		25A	10kW	64 	LTS25 PFLHN4 A8	1	1,44
		32A	12,5kW	64 	LTS32 PFLHN4 A8	1	1,44
		40A	16kW	64 	LTS40 PFLHN4 A8	1	1,44
		63A	22kW	64 	LTS63 PFLHN4 A8	1	1,50
		80A	22kW	64 	LTS80 PFLHN4 A8	1	1,50
		knockoutlets M50/40 +PF3/M50	on request				
Changeover Switch with Padlock Device, lockable							
3-pole, padlock device SV4 							
		20A	7,5kW	64 	LTS20 PFLHN4 U3	1	1,39
		25A	10kW	64 	LTS25 PFLHN4 U3	1	1,39
		32A	12,5kW	64 	LTS32 PFLHN4 U3	1	1,39
		40A	16kW	64 	LTS40 PFLHN4 U3	1	1,39
		63A	22kW	64 	LTS63 PFLHN4 U3	1	1,42
		80A	22kW	64 	LTS80 PFLHN4 U3	1	1,42
4-pole, padlock device SV4 							
		20A	7,5kW	64 	LTS20 PFLHN4 U4	1	1,44
		25A	10kW	64 	LTS25 PFLHN4 U4	1	1,44
		32A	12,5kW	64 	LTS32 PFLHN4 U4	1	1,44
		40A	16kW	64 	LTS40 PFLHN4 U4	1	1,44
		63A	22kW	64 	LTS63 PFLHN4 U4	1	1,50
		80A	22kW	64 	LTS80 PFLHN4 U4	1	1,50

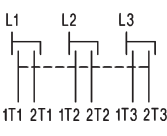
1) PFL.... larger enclosure

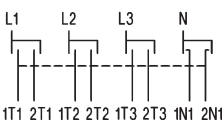



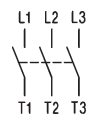

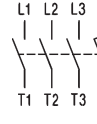
Switch Disconnectors for Panel Mounting, IP66,  Type 3R

		AC21 690V	AC23 3x400V	Plate	Type	Pack pcs.	Weight kg/pcs.
On-Off Switches 3-pole							
		20A	7,5kW	48 □	LTS20 E A3	1	0,15
		25A	10kW	48 □	LTS25 E A3	1	0,15
		32A	12,5kW	48 □	LTS32 E A3	1	0,15
		40A	16kW	48 □	LTS40 E A3	1	0,15
		63A	22kW	48 □	LTS63 E A3	1	0,17
		80A	22kW	48 □	LTS80 E A3	1	0,17
		85A	30kW	64 □	LTS85 E A3	1	0,39
		100A	37kW	64 □	LTS100 E A3	1	0,39
		125A	45kW	64 □	LTS125 E A3	1	0,39
		160A	55kW	88 □	LT160 E T300	1	1,10
On-Off Switches 4-pole							
		20A	7,5kW	48 □	LTS20 E A4	1	0,18
		25A	10kW	48 □	LTS25 E A4	1	0,18
		32A	12,5kW	48 □	LTS32 E A4	1	0,18
		40A	16kW	48 □	LTS40 E A4	1	0,18
		63A	22kW	48 □	LTS63 E A4	1	0,21
		80A	22kW	48 □	LTS80 E A4	1	0,21
		85A	30kW	64 □	LTS85 E A4	1	0,44
		100A	37kW	64 □	LTS100 E A4	1	0,44
		125A	45kW	64 □	LTS125 E A4	1	0,44
		160A	55kW	88 □	LT160 E T400	1	1,50
On-Off Switches 6-pole							
		20A	7,5kW	64 □	LTS20 E A6	1	0,30
		25A	10kW	64 □	LTS25 E A6	1	0,30
		32A	12,5kW	64 □	LTS32 E A6	1	0,30
		40A	16kW	64 □	LTS40 E A6	1	0,30
		63A	22kW	64 □	LTS63 E A6	1	0,36
		80A	22kW	64 □	LTS80 E A6	1	0,36
On-Off Switches 8-pole							
		20A	7,5kW	64 □	LTS20 E A8	1	0,32
		25A	10kW	64 □	LTS25 E A8	1	0,32
		32A	12,5kW	64 □	LTS32 E A8	1	0,32
		40A	16kW	64 □	LTS40 E A8	1	0,32
		63A	22kW	64 □	LTS63 E A8	1	0,43
		80A	22kW	64 □	LTS80 E A8	1	0,43
Changeover Switches 3-pole							
		20A	7,5kW	64 □	LTS20 E U3	1	0,31
		25A	10kW	64 □	LTS25 E U3	1	0,31
		32A	12,5kW	64 □	LTS32 E U3	1	0,31
		40A	16kW	64 □	LTS40 E U3	1	0,31
		63A	22kW	64 □	LTS63 E U3	1	0,37
Changeover Switches 4-pole							
		20A	7,5kW	64 □	LTS20 E U4	1	0,33
		25A	10kW	64 □	LTS25 E U4	1	0,33
		32A	12,5kW	64 □	LTS32 E U4	1	0,33
		40A	16kW	64 □	LTS40 E U4	1	0,33
		63A	22kW	64 □	LTS63 E U4	1	0,44

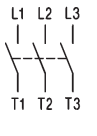
Switch Disconnectors for Single Hole Mounting, lockable IP66, c(UL)us Type 4X

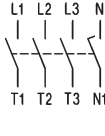
	AC21 690V	AC23 3x400V	Plate	Type	Pack pcs.	Weight kg/pcs.
On-Off Switches 3-pole						
 	20A	7,5kW	48 □	LTS20 Z A3	1	0,16
	25A	10kW	48 □	LTS25 Z A3	1	0,16
	32A	12,5kW	48 □	LTS32 Z A3	1	0,16
	40A	16kW	48 □	LTS40 Z A3	1	0,16
On-Off Switches 4-pole						
 	20A	7,5kW	48 □	LTS20 Z A4	1	0,20
	25A	10kW	48 □	LTS25 Z A4	1	0,20
	32A	12,5kW	48 □	LTS32 Z A4	1	0,20
	40A	16kW	48 □	LTS40 Z A4	1	0,20

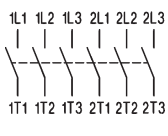
Switch Disconnectors, Base Mounting with Door Clutch for Single-Hole Mounting
Depth X is adjustable (delivered with X_{max} see page 294), IP66, c(UL)us Type 4X

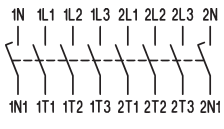
	AC21 690V	AC23 3x400V	Plate	Type	Pack pcs.	Weight kg/pcs.
On-Off Switches 3-pole						
 	20A	7,5kW	64 □	LTS20 VZV A3	1	0,19
	25A	10kW	64 □	LTS25 VZV A3	1	0,19
	32A	12,5kW	64 □	LTS32 VZV A3	1	0,19
	40A	16kW	64 □	LTS40 VZV A3	1	0,19
	63A	22kW	64 □	LTS63 VZV A3	1	0,22
	80A	22kW	64 □	LTS80 VZV A3	1	0,22
	85A	30kW	64 □	LTS85 VZV A3	1	0,40
	100A	37kW	64 □	LTS100 VZV A3	1	0,40
	125A	45kW	64 □	LTS125 VZV A3	1	0,40
	On-Off Switches 4-pole					
 	20A	7,5kW	64 □	LTS20 VZV A4	1	0,20
	25A	10kW	64 □	LTS25 VZV A4	1	0,20
	32A	12,5kW	64 □	LTS32 VZV A4	1	0,20
	40A	16kW	64 □	LTS40 VZV A4	1	0,20
	63A	22kW	64 □	LTS63 VZV A4	1	0,26
	80A	22kW	64 □	LTS80 VZV A4	1	0,26
	85A	30kW	64 □	LTS85 VZV A4	1	0,45
	100A	37kW	64 □	LTS100 VZV A4	1	0,45
	125A	45kW	64 □	LTS125 VZV A4	1	0,45
	On-Off Switches 6-pole					
 	20A	7,5kW	64 □	LTS20 VZV A6	1	0,32
	25A	10kW	64 □	LTS25 VZV A6	1	0,32
	32A	12,5kW	64 □	LTS32 VZV A6	1	0,32
	40A	16kW	64 □	LTS40 VZV A6	1	0,32
	63A	22kW	64 □	LTS63 VZV A6	1	0,37
	80A	22kW	64 □	LTS80 VZV A6	1	0,37
On-Off Switches 8-pole						
 	20A	7,5kW	64 □	LTS20 VZV A8	1	0,34
	25A	10kW	64 □	LTS25 VZV A8	1	0,34
	32A	12,5kW	64 □	LTS32 VZV A8	1	0,34
	40A	16kW	64 □	LTS40 VZV A8	1	0,34
	63A	22kW	64 □	LTS63 VZV A8	1	0,45
	80A	22kW	64 □	LTS80 VZV A8	1	0,45

Switch Disconnecter, Base Mounting with Door Clutch for Single-Hole Mounting
 Depth X is adjustable (delivered with X_{max} see below), IP66,  Type 4X

Depth
 Single Hole Mounting Ø22mm
 LTS.. VZV..

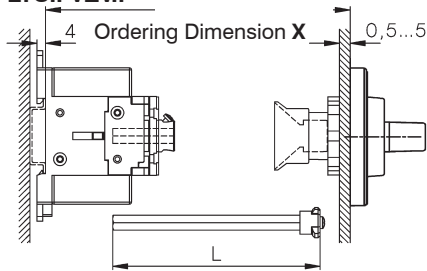



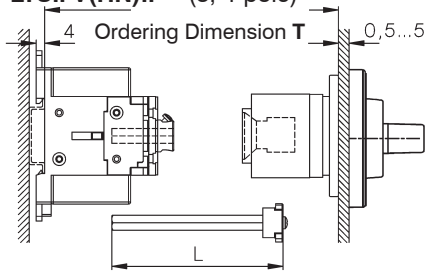

4-Hole Mounting
 LTS.. V(HN).. (3, 4-pole)



Type		X min	X max	L	Type	T min	T max	L	Type	T min	T max
LTS20-80 VZV..	3, 4-polig	91 -	190	X - 40±3	LTS20-80 V..	111 -	190	T - 60±3	LT160 V..	120 -	450
LTS20-80 VZV..	6, 8-polig	111 -	190	X - 60±3	LTS85-125 V..	115 -	190	T - 64±3			
LTS85-125 VZV..	3, 4-polig	95 -	190	X - 44±3							

greater X- and T-Dimensions (max. 380mm for LTS..) on request

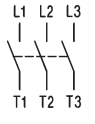
Switch Disconnecter, Base Mounting with Door Clutch for Hole Mounting
 Depth X is adjustable (delivered with T_{max} see above), IP66,  Type 4X

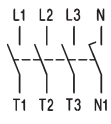
	max. padlocks	AC21 690V	AC23 3x400V	Plate	Type	Pack pcs.	Weight kg/pcs.
On-Off Switches 3-pole							
 		20A	7,5kW	64 □ 1)	LTS20 V A3	1	0,20
		25A	10kW	64 □ 1)	LTS25 V A3	1	0,20
		32A	12,5kW	64 □ 1)	LTS32 V A3	1	0,20
		40A	16kW	64 □ 1)	LTS40 V A3	1	0,20
		63A	22kW	64 □ 1)	LTS63 V A3	1	0,24
		80A	22kW	64 □ 1)	LTS80 V A3	1	0,24
		85A	30kW	64 □ 1)	LTS85 V A3	1	0,40
		100A	37kW	64 □ 1)	LTS100 V A3	1	0,40
		125A	45kW	64 □ 1)	LTS125 V A3	1	0,40
		160A	55kW	88 □	LT160 V T300	1	1,38
On-Off Switches 4-pole							
 		20A	7,5kW	64 □ 1)	LTS20 V A4	1	0,21
		25A	10kW	64 □ 1)	LTS25 V A4	1	0,21
		32A	12,5kW	64 □ 1)	LTS32 V A4	1	0,21
		40A	16kW	64 □ 1)	LTS40 V A4	1	0,21
		63A	22kW	64 □ 1)	LTS63 V A4	1	0,28
		80A	22kW	64 □ 1)	LTS80 V A4	1	0,28
		85A	30kW	64 □ 1)	LTS85 V A4	1	0,45
		100A	37kW	64 □ 1)	LTS100 V A4	1	0,45
		125A	45kW	64 □ 1)	LTS125 V A4	1	0,45
		160A	55kW	88 □	LT160 V T400	1	1,77

Add-on modules see page 297

1) Types with padlock device 88 r type suffix **88**, ordering example: LTS32 VHN488 A3, on request

Switch Disconnecter, Base Mounting with Door Clutch for Single-Hole Mounting
 Depth X is not adjustable, declare depth X when ordering, IP66, cUL_{us} Type 4X

	max. padlocks	AC21 690V	AC23 3x400V	Plate	Type	Pack pcs.	Weight kg/pcs.
On-Off Switches 4-pole							
		20A	7,5kW	64 □	LTS20 VZ A4 X..	1	0,18
		25A	10kW	64 □	LTS25 VZ A4 X..	1	0,18
		32A	12,5kW	64 □	LTS32 VZ A4 X..	1	0,18
		40A	16kW	64 □	LTS40 VZ A4 X..	1	0,18
		63A	22kW	64 □	LTS63 VZ A4 X..	1	0,25
		80A	22kW	64 □	LTS80 VZ A4 X..	1	0,25

Declare depth X when ordering

Type	Preference values for X
LTS.. VZ..	80, 85, 104, 129 (tolerance -3, +1,5)

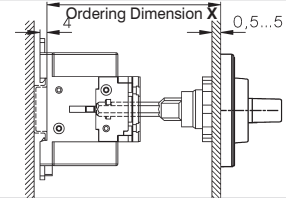

Add-on modules see page 297

Switch Disconnectors for Distribution Boards, IP40, cUL_{us} Open Type

On-Off Switches 3-pole							
		20A	7,5kW	52x45	LTS20 SMA A3	1	0,15
		25A	10kW	52x45	LTS25 SMA A3	1	0,15
		32A	12,5kW	52x45	LTS32 SMA A3	1	0,15
		40A	16kW	52x45	LTS40 SMA A3	1	0,15
		63A	22kW	52x45	LTS63 SMA A3	1	0,17
		80A	22kW	52x45	LTS80 SMA A3	1	0,17
	85A	30kW	78x45	LTS85 SMA A3	1	0,37	
	100A	37kW	78x45	LTS100 SMA A3	1	0,37	
	125A	45kW	78x45	LTS125 SMA A3	1	0,37	

On-Off Switches 4-pole							
		20A	7,5kW	52x45	LTS20 SMA A4	1	0,16
		25A	10kW	52x45	LTS25 SMA A4	1	0,16
		32A	12,5kW	52x45	LTS32 SMA A4	1	0,16
		40A	16kW	52x45	LTS40 SMA A4	1	0,16
		63A	22kW	52x45	LTS63 SMA A4	1	0,21
		80A	22kW	52x45	LTS80 SMA A4	1	0,21
	85A	30kW	78x45	LTS85 SMA A4	1	0,42	
	100A	37kW	78x45	LTS100 SMA A4	1	0,42	
	125A	45kW	78x45	LTS125 SMA A4	1	0,42	

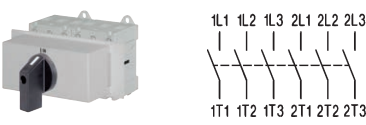

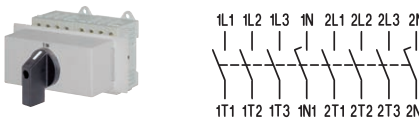

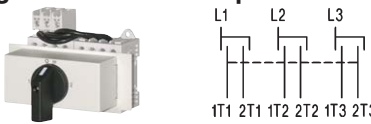

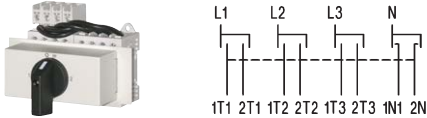

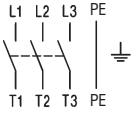

On-Off Switches 6-pole							
		20A	7,5kW	52x45	LTS20 SMA A6	1	0,29
		25A	10kW	52x45	LTS25 SMA A6	1	0,29
		32A	12,5kW	52x45	LTS32 SMA A6	1	0,29
		40A	16kW	52x45	LTS40 SMA A6	1	0,29
		63A	22kW	97x45	LTS63 SMA A6	1	0,34
		80A	22kW	97x45	LTS80 SMA A6	1	0,34

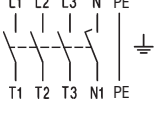
On-Off Switches 8-pole							
		20A	7,5kW	97x45	LTS20 SMA A8	1	0,31
		25A	10kW	97x45	LTS25 SMA A8	1	0,31
		32A	12,5kW	97x45	LTS32 SMA A8	1	0,31
		40A	16kW	97x45	LTS40 SMA A8	1	0,31
		63A	22kW	126x45	LTS63 SMA A8	1	0,42
		80A	22kW	126x45	LTS80 SMA A8	1	0,42

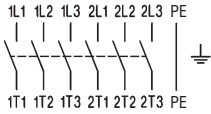
Changeover Switches 3-pole							
		20A	7,5kW	97x45	LTS20 SMA U3	1	0,30
		25A	10kW	97x45	LTS25 SMA U3	1	0,30
		32A	12,5kW	97x45	LTS32 SMA U3	1	0,30
		40A	16kW	97x45	LTS40 SMA U3	1	0,30
		63A	22kW	97x45	LTS63 SMA U3	1	0,35

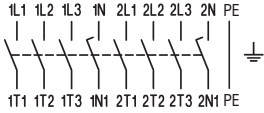

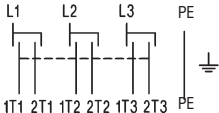

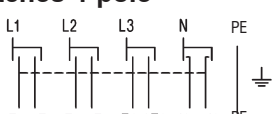









Changeover Switches 4-pole							
		20A	7,5kW	97x45	LTS20 SMA U4	1	0,32
		25A	10kW	97x45	LTS25 SMA U4	1	0,32
		32A	12,5kW	97x45	LTS32 SMA U4	1	0,32
		40A	16kW	97x45	LTS40 SMA U4	1	0,32
		63A	22kW	126x45	LTS63 SMA U4	1	0,43

Switch Disconnectors in Plastic Enclosure IP66, Type 4X



	AC21 690V	AC23 3x400V	Plate	Type	Pack pcs.	Weight kg/pcs.
On-Off Switches 3-pole  	20A	7,5kW	64 □	LTS20 PF(L ¹) A3	1	0,30
	25A	10kW	64 □	LTS25 PF(L ¹) A3	1	0,30
	32A	12,5kW	64 □	LTS32 PF(L ¹) A3	1	0,30
	40A	16kW	64 □	LTS40 PF(L ¹) A3	1	0,30
	63A	22kW	64 □	LTS63 PFL A3	1	0,58
	80A	22kW	64 □	LTS80 PFL A3	1	0,58
On-Off Switches 4-pole  	20A	7,5kW	64 □	LTS20 PF(L ¹) A4	1	0,31
	25A	10kW	64 □	LTS25 PF(L ¹) A4	1	0,31
	32A	12,5kW	64 □	LTS32 PF(L ¹) A4	1	0,31
	40A	16kW	64 □	LTS40 PF(L ¹) A4	1	0,31
	63A	22kW	64 □	LTS63 PFL A4	1	0,62
	80A	22kW	64 □	LTS80 PFL A4	1	0,62
On-Off Switches 6-pole  	20A	7,5kW	64 □	LTS20 PFL A6	1	1,39
	25A	10kW	64 □	LTS25 PFL A6	1	1,39
	32A	12,5kW	64 □	LTS32 PFL A6	1	1,39
	40A	16kW	64 □	LTS40 PFL A6	1	1,39
	63A	22kW	64 □	LTS63 PFL A6	1	1,42
	80A	22kW	64 □	LTS80 PFL A6	1	1,42
knockoutlets M50/40 +PF3/M50 on request						
On-Off Switches 8-pole  	20A	7,5kW	64 □	LTS20 PFL A8	1	1,44
	25A	10kW	64 □	LTS25 PFL A8	1	1,44
	32A	12,5kW	64 □	LTS32 PFL A8	1	1,44
	40A	16kW	64 □	LTS40 PFL A8	1	1,44
	63A	22kW	64 □	LTS63 PFL A8	1	1,50
	80A	22kW	64 □	LTS80 PFL A8	1	1,50
knockoutlets M50/40 +PF3/M50 on request						
Changeover Switches 3-pole  	20A	7,5kW	64 □	LTS20 PFL U3	1	1,39
	25A	10kW	64 □	LTS25 PFL U3	1	1,39
	32A	12,5kW	64 □	LTS32 PFL U3	1	1,39
	40A	16kW	64 □	LTS40 PFL U3	1	1,39
	63A	22kW	64 □	LTS63 PFL U3	1	1,42
	80A	22kW	64 □	LTS80 PFL U3	1	1,42
Changeover Switches 4-pole  	20A	7,5kW	64 □	LTS20 PFL U4	1	1,44
	25A	10kW	64 □	LTS25 PFL U4	1	1,44
	32A	12,5kW	64 □	LTS32 PFL U4	1	1,44
	40A	16kW	64 □	LTS40 PFL U4	1	1,44
	63A	22kW	64 □	LTS63 PFL U4	1	1,50
	80A	22kW	64 □	LTS80 PFL U4	1	1,50

1) PFL.... larger enclosure













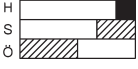

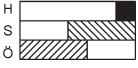
Add-on Modules for Main Switches, Panel Mounting and Single Hole Mounting

	for switch	Type	Pack pcs.	Weight kg/pcs.	
	4th Add-on Neutral Switching Pole 	LTS20 ... to LTS40 ... LTS63 ... , LTS80 ...	N40E N80E	1 1	0,035 0,042
	Aux. Contact Block 1NO + 1NC 	LTS20 ... to LTS125 ...	LH11	1	0,02
	Aux. Contact Block 1NO + 1NC Overlapping 	LTS20 ... to LTS125 ...	LH11X	1	0,02
	Aux. Contact Block 2NC 	LTS20 ... to LTS125 ...	LH20V/02E	1	0,02
	PE-Terminal 	LTS20 ... to LTS80 ... LT125 E.. to LT160 E..	PE80E LTXX-E/E	1 1	0,04 0,2
	N-Terminal 	LTS20 ... to LTS80 ... LT125 E.. to LT160 E..	PEN80E LTXX-N/E	1 1	0,04 0,2
	Terminal Cover 3-pole	LTS20 ... to LTS80 ... LTS85.. to LTS125. LT125.. to LT160..	KLAD70 KLAD125 XX-KLAD3	1 1 1	0,005 0,01 0,02
	Terminal Cover for 4th pole	Mains Load circuit	LTS20 ... to LTS80.. LTS20 ... to LTS80.. KLAD70N KLAD70NI	1 1	0,002 0,002
	Terminal Cover 4-pole	LTS85.. to LTS125. LT125.. to LT160..	KLAD125 XX-KLAD4	1 1	0,01 0,02

Accessories for Main Switches, Panel Mounting, Single Hole and Base Mounting

	for switch	Type	Pack pcs.	Weight kg/pcs.		
	Additional Escutcheon Plate Yellow, Marked with: HAUPTSCHALTER	for plate 48 ^r for plate 64 ^r	LTS.. .HN1.. LTS.. .HN4..	A91501 E91501	1 1	0,003 0,005
	Additional Escutcheon Plate Yellow, Marked with: MAIN SWITCH	for plate 48 ^r for plate 64 ^r	LTS.. .HN1.. LTS.. .HN4..	A91524 E91524	1 1	0,003 0,005
	Tab Terminal 6,3 x 0,8mm	LTS20 ... bis LTS40 ...	LG11073	10	0,001	

Add-on Modules for Main Switches, Base and Rail Mounting

		for switch	Type	Pack pcs.	Weight kg/pcs.	
	4th Add-on Neutral Switching Pole					
		LTS20 ... , LTS40 ... LTS63 ... , LTS80 ...	N40V N80V	1 1	0,035 0,042	
	Aux. Contact Block 1NO + 1NC					
		LTS20 ... to LTS125 ...	LH11	1	0,02	
	Aux. Contact Block 1NO + 1NC Overlapping					
		LTS20 ... to LTS125 ...	LH11X	1	0,02	
	Aux. Contact Block 2NO					
		LTS20 ... to LTS80 ...	LH20V/02E	1	0,02	
	PE-Terminal					
		LTS20 ... to LTS80 ... LT125 .. to LT160 .. LTXE-E/V	PE80V	1 1	0,04 0,2	
	N-Terminal					
		LTS20 ... to LTS80 ... LT125 .. to LT160 .. LTXE-N/V	PEN80V	1 1	0,04 0,2	
	Terminal Cover 3-pole					
		LTS20 ... to LTS40 ...	KLAD40	1	0,005	
		LTS63 ... to LTS80 ...	KLAD70	1	0,005	
		LTS85.. to LTS125.	KLAD125	1	0,01	
		LT125.. to LT160..	XX-KLAD3	1	0,02	
	Terminal Cover for 4th pole					
	Mains Load circuit	LTS63.., LTS80.. LTS63.., LTS80..	KLAD70N KLAD70NI	1 1	0,002 0,002	
	Terminal Cover 4-pole					
		LTS20 ... to LTS40 ...	KLAD40	1	0,005	
		LTS85.. to LTS125.	KLAD125	1	0,01	
		LT125.. to LT160..	XX-KLAD4	1	0,02	
	Additional Cover SMA for					
	4. Pole	N40V, N80V	grey	LG8628-2	1	0,047
	Aux. Contacts	LH..	yellow	LG8628-7	1	0,047
	PE and N-Terminal	PE80V, PEN80V				

Technical Data

Data according to IEC 947-3, IEC 947-5-1, VDE 0660, EN 60947-3, EN 60947-5-1

Type	LTS20	LTS25	LTS32	LTS40	LTS63	LTS80	LTS85	LTS100	LTS125	LT160	
Main contacts											
Rated thermal current I_{th} open	A	20	25	32	40	63	80	85	100	125	160
Rated thermal current I_{the} enclosed	A	20	25	32	40	63	80	85	100	110	160
Rated insulation voltage U_i 1)	V	690	690	690	690	690	690	1000 ⁵⁾	1000 ⁵⁾	1000 ⁵⁾	1000 ³⁾
Rated operational current I_e AC21A	A	20	25	32	40	63	80	85	100	125	160
Making capacity I_{eff} 3x380-440V	A	160	190	220	300	370	440	600	725	850	1050
Breaking capacity 3x220-240V	A	160	180	200	250	330	380	480	580	680	900
	A	160	180	200	250	330	380	480	580	680	850
	A	80	110	140	170	190	220	250	330	420	340
Disconnection property performed up to	V	690	690	690	690	690	690	1000	1000	1000	1000 ³⁾
Motor Switch AC3 3x400V	A	12	16	23	30	37	37	45	60	72	85
Motor Switch AC3 3x220-240V	kW	3	4	5,5	7,5	11	11	15	18,5	22	30
Direct switching of single motors 3x380-440V	kW	5,5	7,5	11	15	18,5	18,5	22	30	37	45
	kW	5,5	7,5	11	15	18,5	18,5	18,5	22	30	37
Main Switch AC23 3x400V	A	16	20	25	32	45	45	60	72	85	110
Motor Switch, AC23A, 3x220-240V	kW	4	5,5	7,5	9	15	15	18,5	22	30	30
Main Switch, AC23B 3x380-440V	kW	7,5	10	12,5	16	22	22	30	37	45	55
Safety Switch 3x660-690V	kW	5,5	7,5	11	15	18,5	18,5	22	30	37	37
Rated conditional short-circuit current kA_{eff}	10	10	10	10	10	10	10	10	10	5	30
Max. fuse size gL (gG)	A	25	35	40	40	63	80	100	100	125	160
Mechanical life $x10^3$	200	200	200	200	100	100	100	100	100	100	100
Rated short-time withstand current (1sec. current)	A	250	300	400	500	600	850	1000	1200	1500	3000
Power loss per pole AC21 = I_{th}	P/pole [W]	E, Z	0,322	0,503	0,824	1,288	2,739	4,416	3,851	5,330	8,328
		V, SMA, PF	0,364	0,569	0,933	1,458	2,739	4,416	3,851	5,330	8,328
	R/pole [mOhm]	E, Z	0,805	0,805	0,805	0,805	0,690	0,690	0,533	0,533	0,533
		V, SMA, PF	0,911	0,911	0,911	0,911	0,690	0,690	0,533	0,533	0,533
Maximum ambient temperature											
Operation	open	-40°C to +60°C									
	enclosed	-40°C to +40°C									
Storage		-50°C to +90°C									
Cable cross sections											
solid or stranded	mm ²	0,5 - 10			1 - 25 ⁶⁾			4 - 50		max.95	
	AWG	20 - 8 (10)			16 - 4 (10)			12 - 00 (10)		max.3/0	
flexible	mm ²	0,5 - 6			4 - 16 ⁶⁾			10 - 35		max.70	
	AWG	20 - 10			16 - 6			8 - 2		max.2/0	
flexible (+ multicore cable end)	mm ²	0,5 - 6			0,75 - 16 ⁶⁾			6 - 35		max.50	
	AWG	20 - 10			16 - 6			8 - 2		max.1/0	
Size of terminal screw		M3,5			M5			M6		M10	
Tightening torque	Nm	1,7 - 2,3			2,8 - 4			1,7 - 4,5		14	
Auxiliary contacts											
Rated insulation voltage U_i 1)	V	690			690			690		690	
Rated thermal current I_{th} , I_{the}	A	10			10			10		16	
Switching capacity AC15 380-450V	A	2,5/1,5			2,5/1,5			2,5/1,5		6/4	
	A	2/0,4			2/0,4			2/0,4		-	
Rated conditional short-circuit current kA_{eff}	3	3			3			3		3	
	A	10			10			10		16	
Cable cross sections											
solid or stranded	mm ²	0,75 - 2,5			0,75 - 2,5			0,75 - 2,5		max.4	
	AWG	14 - 12			14 - 12			14 - 12		max.12	
flexible (+ multicore cable end)	mm ²	0,75 - 2,5 (1,5)			0,75 - 2,5 (1,5)			0,75 - 2,5 (1,5)		max.2,5	
	AWG	18 - 14			18 - 14			18 - 14		max.14	
Data according to UL and cUL											
Type	LTS20	LTS25	LTS32	LTS40	LTS63	LTS80	LTS85	LTS100	LTS125	LT160	
Rated voltage	V	600	600	600	600	600	600	600	600	600	
Ampere-Rating "General use"	A	20	25	32	40	63	80	85	100	125	
DOL-Rating 3-phase	110-120V	HP	1	1,5	2	2	3	5	7,5	10	15
	220-240V	HP	3	5	5	5	10	10	20	25	30
	440-480V	HP	7,5	10	10	10	20	20	40	50	60
	550-600V	HP	10	10	15	15	25	25	50	60	60
DOL-Rating 1-phase	110-120V	HP	1	1	1	1	2	2	3	5	7,5
	200-208V	HP	1	2	2	2	3	3	7,5	10	10
	220-240V	HP	2	2	3	3	5	5	10	15	15
Fuse size (RK5) Manual Motor Controller	A	40	50	50	70	90	110	125	125	125	400 ⁴⁾
5kA / 600V Motor Disconnect	A	40	50	50	50	70	70	125	125	125	400 ⁴⁾
Tightening torque	Nm	1,7-2,3	1,7-2,3	1,7-2,3	1,7-2,3	2,8-4	2,8-4	1,7-4,5	1,7-4,5	1,7-4,5	14
	lb.inch	15-20	15-20	15-20	15-20	25-35	25-35	15-40	15-40	15-40	124

1) suitable for: earthed-neutral systems, overvoltage category I to III, pollution degree 3 (standard-industry): $U_{imp} = 6kV$.

2) the values after the slash are valid for switches 6-pole or more

3) Suitable for no load applications(AC20A) above 690V

4) Fuse RK1 / 10kA / 600V

5) $U_{imp} = 8kV$

6) LTS63..U. stranded 16mm², flexible 10mm²

Dimensions (mm)

Main Switches, Switch Disconnectors LT(S)..

Panel mounting LT(S).. E(HN)..
ON-OFF Switches 3-pole, 4-pole

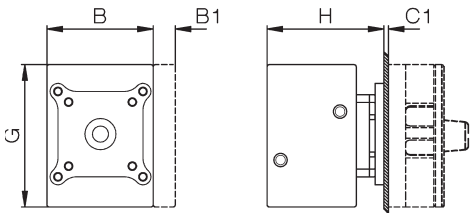

ON-OFF Switches 6-pole, 8-pole
Changeover Switches 3-pole, 4-pole

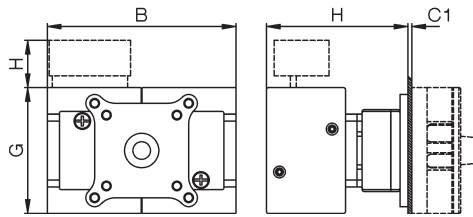

Mounting holes
Mounting screw: J3631N M=1,2-1,4 Nm

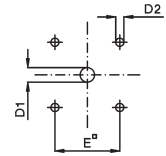

Single hole mounting LTS.. Z(HN)..
ON-OFF Switches 3-pole, 4-pole

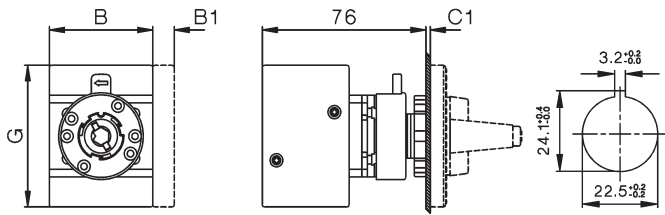

Mounting holes

Mounting of add-on modules LTS20 - LTS80
Panel mounting, Single hole mounting

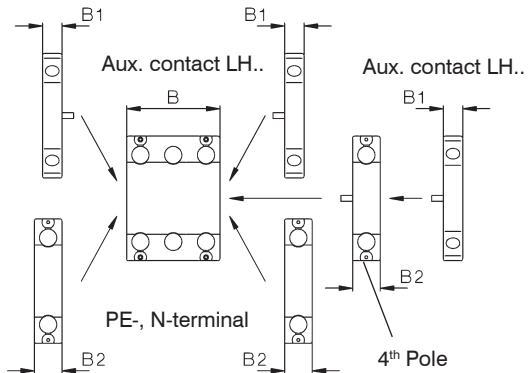

Type	Changeover ON-OFF Escutch. plate or padlock device	3-pole		4-pole		aux. contact B1	4 Pole				3,4-pole						
		A	B	B	B		B	PE B2	C1	D1	D2	E	F	G	3-pole 4-pole X	6-pole 8-pole X	H
LTS20-80..	48 □, SV1	48	48	62,5	-	-	10	14,5	1-5	9	5	36	-	64	54	-	24
LTS20-80..	64 □, SV4, SV164	64	48	62,5	97	126	10	14,5	1-5	9	5	48	-	64	54	74	24
LTS85-125..	64 □, SV4	64	78	78	-	-	10	-	1-5	9	5	48	-	85	60	-	-
LTS85-125..	88 □, SV488	88	78	78	-	-	10	-	1-5	9	6	68	-	85	60	-	-
LT160	88 □, SV34	88	112	150	224	-	-	-	1-4	13-17	6	68	49,3	108	96	98	-

Escutcheon plate
48 □

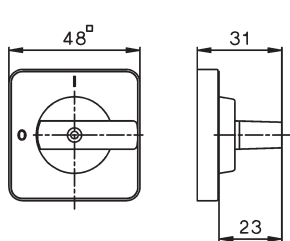

64 □

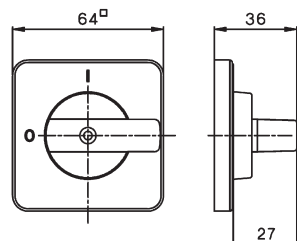

Padlock devices
SV1

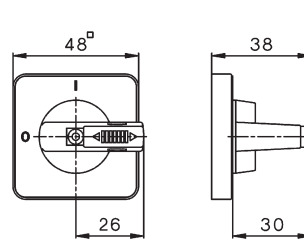

SV164

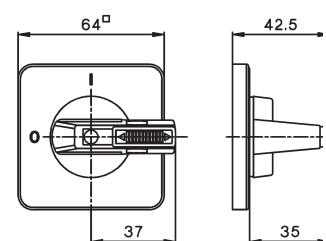

Padlock devices
SV4

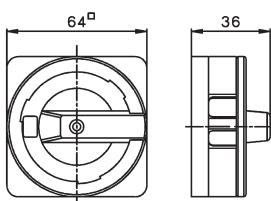

SV488

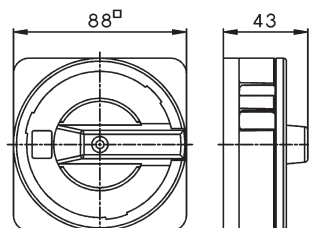

SV34

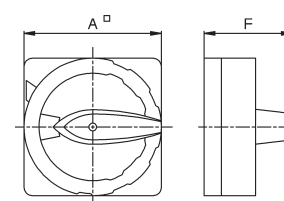

Extended Switch Shaft
+VW"x"

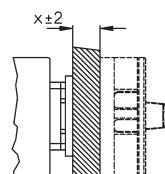

Dimensions (mm)

Main Switches, Switch Disconnectors LT(S)..

Base mounting LTS.. VZV(HN)..
ON-OFF Switches 3-pole, 4-pole

$L = X - 40 \pm 3$ for LTS20 - 80
 $L = X - 44 \pm 3$ for LTS85 - 125

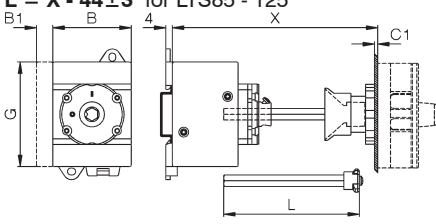

6-pole
for LTS20 - 40 only
 $L = X - 40 \pm 3$

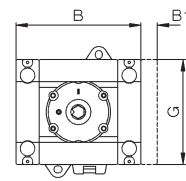

ON-OFF Switches 6-pole, 8-pole
Changeover Switches 3-pole, 4-pole
 $L = X - 60 \pm 3$

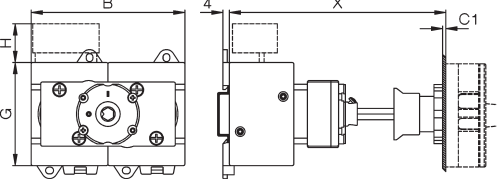

Mounting holes

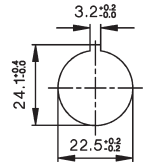

Base mounting LT(S).. V(HN)..
ON-OFF Switches 3-pole, 4-pole

$L = T - 60 \pm 3$ for LTS20 - 80
 $L = T - 64 \pm 3$ for LTS85 - 125

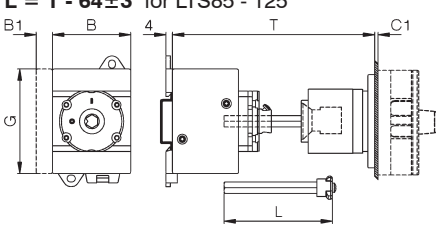

6-pole
for LTS20 - 40 only
 $L = T - 60 \pm 3$

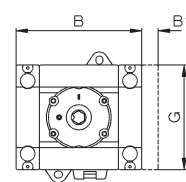

ON-OFF Switches 6-pole, 8-pole
Changeover Switches 3-pole, 4-pole
 $L = T - 80 \pm 3$ for LTS20 - 80 only

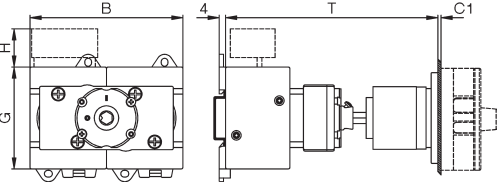

Mounting holes

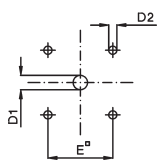

Base mounting LTS.. VZ(HN)..
ON-OFF Switches 3-pole, 4-pole
Preference values for X: 80, 85, 104, 129

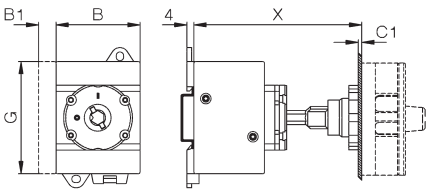

6-pole
for LTS20 - 40 only

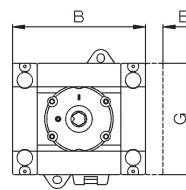

ON-OFF Switches 6-pole, 8-pole
Changeover Switches 3-pole, 4-pole

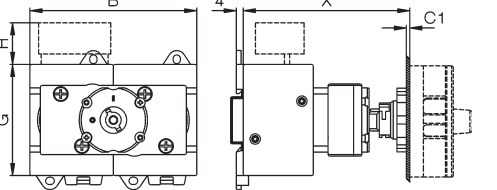

Mounting holes

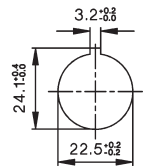

Type	Changeover ON-OFF Escutch. plate or padlock device	3-pole				4-pole		6-pole		3,4-pole 8-pole		aux. contact		4 Pole PE		C1	D1	D2	D3	E	G	K	K1	J	
		A	B	B	B	B	B	B1	B2	H															
LTS20 -40	64 [□] , SV4, SV164	64	48	48	77	97	10	14,5	24	1-5	9	5	M4	48	64	25	48	70							
LTS63, 80	64 [□] , SV4, SV164	64	48	62,5	97	126	10	14,5	24	1-5	9	5	M4	48	64	25	48	70							
LTS85-125..	64 [□] , SV4	64	78	78	-	-	10	-	-	1-5	9	5	M4	48	85	38	-	90							
LT125/160	88 [□] , SV34	88	112	150	224	-	-	-	-	1-4	13/27 ²⁾	6	M6	68	108	36	-	120							

Base mounting
ON-OFF Switches LTS20 - LTS80
3-pole, 4-pole
6-pole LTS20 -40

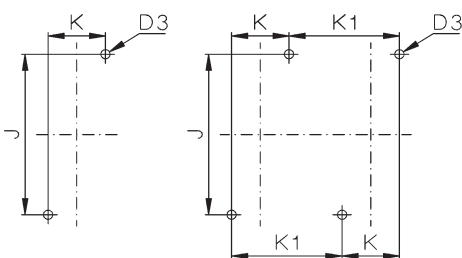

LTS85-125, LT160
3-pole, 4-pole

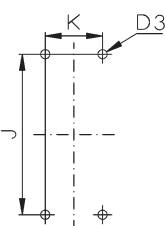

Mounting of Accessories LTS20 - LTS80
Base mounting, for distribution boards

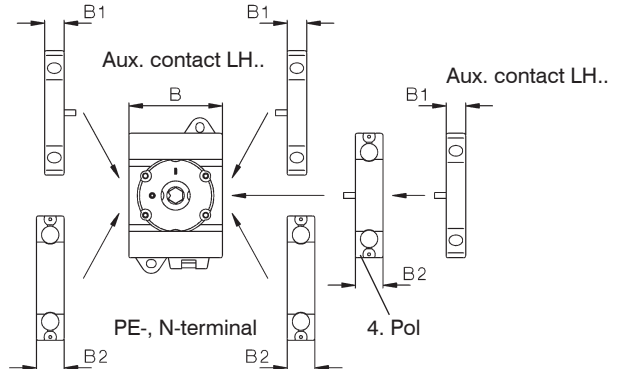

1) Ø 22-25 for LT80(100) VH(N)34 .. only
2) Ø 26-30 for LT125(160) VH(N)34 .. only

Dimensions (mm)

Main Switches, Switch Disconnectors LT(S)..

Installation cover LT(S).. SMA(HN)..

ON-OFF Switches 3-pole, 4-pole

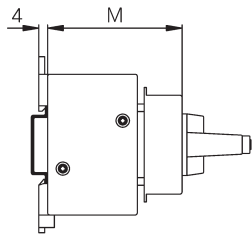
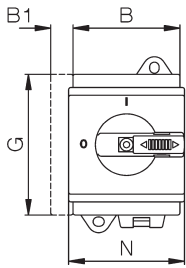

ON-OFF Switches 6-pole
for LTS20 - 40 only

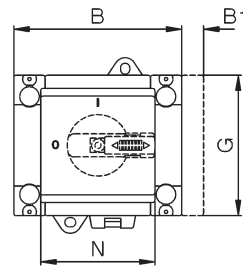

ON-OFF Switches 6-pole, 8-pole
Changeover Switches 3-pole, 4-pole

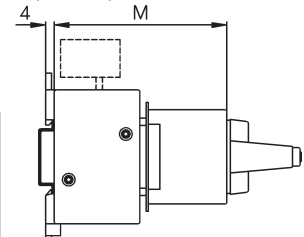
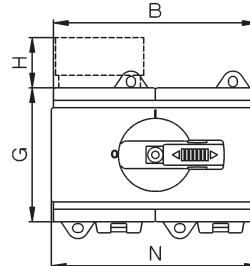

Type	padlock device	Changeover ON-OFF						G	3,4-pole			3,4-pole			H	
		3-pole	4-pole	6-pole	8-pole	aux. contact	4.pole PE		3-pole 4-pole	6-pole	8-pole	3-pole 4-pole	6-pole	8-pole		
		B	B	B	B	B1	B2	M		M	M	N	N	N		
LTS20 - 40	SV1, SV164	48	48	77	96	10	14,5	64	60	60	74	52	52	97 ²⁾	24	
LTS63, 80	SV1, SV164	48	62,5	96	125	10	14,5	64	60	74	74	52	97 ²⁾	126 ¹⁾		
LTS85-125..	SV164	78	78	-	-	10	-	85	60	-	-	78	-	-		

Installation cover with low height handle LTS SMAHN1.. +SV1N

Main switch 3-pole, 4-pole

LTS20 - LTS80

Padlock device SV1

Padlock device SV164

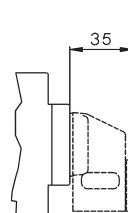
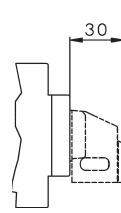
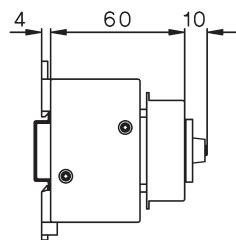
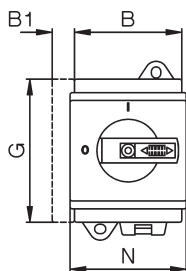

1) Original cover

2) Remove cover parts

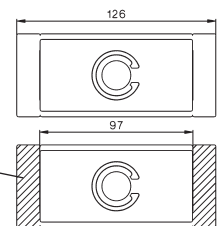

Maintenance and Safety Switches LT(S)..PF.

Type	pole	size	A	B	C	D1	D2	E	F	H
LTS20 PFH.. A. - LTS40 PFH.. A. ³⁾	3, 4	PF1	130	98	120	2x25,5/20,5	-	75	100	76
LTS20 PFLH.. A., LTS40 PFLH.. A. ³⁾	3, 4	PFL	180	98	170	2x25,5/20,5 / 16,5/12,5-	-	75	150	76
LTS20 PFLH.. A. - LTS40 PFLH.. A. ⁴⁾	6	PFL2	200	140	188,5	40,5/32,5+16,5+12,5	-	100	160	86
LTS63 PFLH.. A. - LTS80 PFLH.. A. ⁴⁾	3, 4	PFL2	200	140	188,5	40,5/32,5+16,5+12,5	-	100	160	86
+ PF3	3, 4	PFL3	240	176	228,5	2x40,5/32,5	-	120	200	120
+ PF3/M50	3, 4	PFL3	240	176	228,5	50,5/40,5	-	120	200	120
LTS85 PFLH.. A. - LTS125 PFLH.. A. ⁴⁾	3, 4	PFL2	200	140	188,5	40,5/32,5+16,5+12,5	-	100	160	86
LTS20 PFLH.. A. - LTS40 PFLH.. A. ⁵⁾	8	PFL3	240	176	228,5	2x40,5/32,5	-	120	200	120
LTS63 PFLH.. A. - LTS80 PFLH.. A. ⁵⁾	6, 8	PFL3	240	176	228,5	2x40,5/32,5	-	120	200	120
LTS85 PFLH.. A. - LTS125 PFLH.. A. ⁵⁾	3, 4	PFL3	240	176	228,5	50,5/40,5	-	120	200	120
LT160 PF..	3	PF4	300	200	-	2x50,5	25,5	172	272	172
LT160 PF..	4	PF5	300	280	-	2x50,5	-	254	254	180

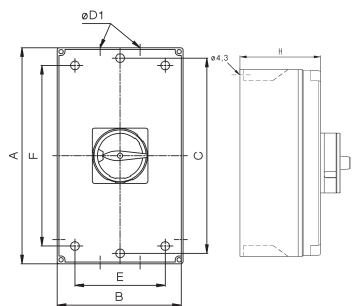

Switch Disconnectors in Plastic Enclosure LTS..PF.

Type	pole	size	A	B	C	D1	E	F	H
LTS20 PF A., LTS40 PF A. ³⁾	3, 4	PF1	130	98	121	2x25,5/20,5	75	100	76
LTS20 PFL A., LTS40 PFL A. ³⁾	3, 4	PFL	180	98	170	2x25,5/20,5 / 16,5/12,5	75	150	76
LTS63 PFL A., LTS80 PFL A. ⁴⁾	3, 4	PFL2	200	140	188,5	40,5/32,5+16,5+12,5	100	160	86
+ PF3	3, 4	PFL3	240	176	228,5	2x40,5/32,5	120	200	120
+ PF3/M50	3, 4	PFL3	240	176	228,5	50,5/40,5	120	200	120

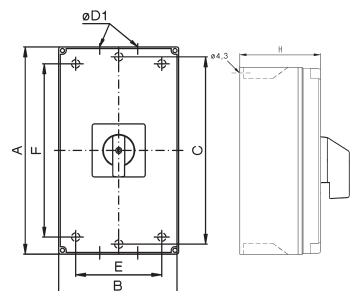

Max. quantity of poles + aux. contacts in enclosure:

3) LTS40 PF. A5 + LH11

4) LTS40 PFL.. A6, LTS80 PFL.. A5 + LH11, LTS125 PFL.. A4 + LH11

5) LTS40 PFL.. A10, LTS40 PFL.. U4 + LH11, LTS80 PFL.. A8, LTS80 PFL.. A6 + LH11, LTS80 PFL.. U4, LTS40 PFL.. U3 + LH11, LTS125 PFL.. A4+LH11

Index

Page



ON-OFF Switches for Panel Mounting

306



ON-OFF Switches for Single Hole Mounting

307



ON-OFF Switches for Base Mounting with Door Clutch

308



ON-OFF Switches for Distribution Boards

309



Main Switches for Panel Mounting

310



Main Switches for Single Hole Mounting

311



Main Switches for Base Mounting with Door Clutch

312



Main Switches for Distribution Boards

313



Main Switches in Plastic Enclosure

314



Technical Datas
Approvals
Dimensions

315

319

325

Contactors, Motor-Starter

Circuit Breakers

Manual Motor-Starters

Switches

AC-Main Switches

DC-Switch Disconnector

Push Buttons

Representatives, Suppliers

Ratings				DC-Switch Disconnectors				
Type	I _{th} open A	DC21B(DC-PV1) at U _e		Design	Panel mounting 4-hole mounting IP66 ¹⁾ Type 3R	Single hole mounting Ø22,5mm IP66 ¹⁾ Type 4X	Base mounting w. door coupling IP66 ¹⁾ Type 4X	Modular switch IP40 ¹⁾ Open Type
		4 poles in series A	V					
LS16	16	16	1000	.. E Z(O) VZV SMA ..	
LS25	25	25	1000	.. E Z(O) VZV SMA ..	
LS32	32	32	1000	.. E Z(O) VZV SMA ..	
LS40	40	25	1000	.. E ..	-	.. VZV SMA ..	
LS55	55	32	1000	.. E ..	-	.. VZV SMA ..	

Switch Disconnectors for Photovoltaic

Switch disconnectors „LS..“ are switch gears for interrupting the DC/AC-Inverter from the solar-panels. Photovoltaic-installations have to be equipped with DC-isolators according to IEC 60364-7-712.

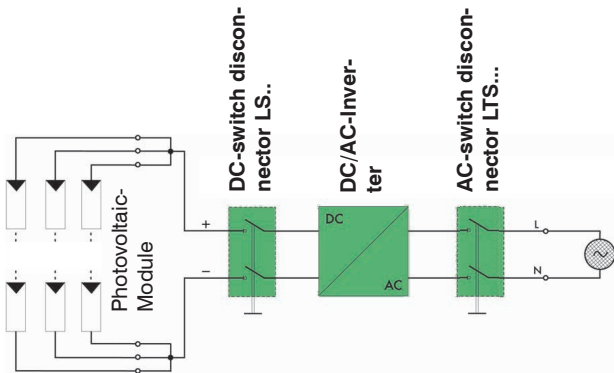

Switch disconnectors „LS..“ ensures a reliable switching up to 85A with 1500V in the category DC21B (DC-PV1).

The construction of the contacts and the material selection guarantee that no oxidation (small switching frequency) develops, and is thus prevented inadmissible heating-up.

The switch disconnector has 2, 4, 6 or 8 contacts, by serial or parallel wiring of the contacts the contact rating will be increased.

The switching speed at the manually operated handle does not have an effect on the switching attitude of the contacts.

Switching programs

Type	2-pole	2+2-pole 2 poles in series +2 poles parallel	4-pole	4-pole with jumpers Input on top Output bottom	4-pole with jumpers Input and Output bottom	4-pole with jumpers Input and Output on top
LS16	.. A2	.. A2+2	..A4(2 x A2)	.. A4B	.. A4O	.. A4U
LS25	.. A2	.. A2+2	..A4(2 x A2)	.. A4B	.. A4O	.. A4U
LS32	.. A2	.. A2+2	..A4(2 x A2)	.. A4B	.. A4O	.. A4U
LS40	.. A2	.. A2+2	..A4(2 x A2)	.. A4B	.. A4O	.. A4U
LS55	.. A2	.. A2+2	..A4(2 x A2)	.. A4B	.. A4O	.. A4U

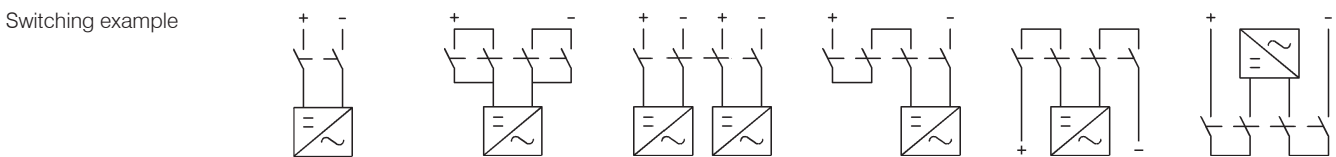
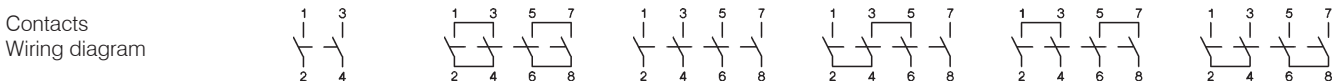

Ordering

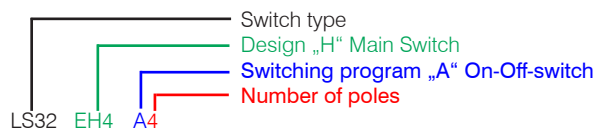

1) Protection in front and built in

DC-Main Switch

Panel mounting
Four-hole mounting
IP66¹⁾ Type 3R



Single hole mounting
Ø22,5mm IP66¹⁾
Type 4X



Base mounting
with door coupling
IP66¹⁾ Type 4X



Modular
switch IP40¹⁾
Open Type



Plastic enclosed
PFL..IP67 Type 4X



.. EH4 Z(O)H1 VZVH4 SMAH1 PFLH4 ..
.. EH4 Z(O)H1 VZVH4 SMAH1 PFLH4 ..
.. EH4 Z(O)H1 VZVH4 SMAH1 PFLH4 ..
.. EH4 ..	-	.. VZVH4 SMAH1 PFLH4 ..
.. EH4 ..	-	.. VZVH4 SMAH1 PFLH4 ..

Technical data for DC, according to IEC 60947-3, VDE0660, more data see page 315

Type		DC21B (DC-PV1)								DC22B			
		500V	600V	700V	800V	900V	1000V	1200V	1500V	500V	600V	800V	1000V
2 poles in series 	LS16 ..	16A	16A	16A	16A	16A	10A	7A	3A	7A	5,5A	2A	1A
	LS25..	25A	25A	25A	19A	17A	11,5A	8,5A	5A	8A	6A	2,5A	1,5A
	LS32 ..	32A	32A	32A	23A	20A	13A	10A	6A	9A	6,5A	3A	2A
	LS40 ..	40A	40A	37A	35A	31A	29A	11A	7,5A	-	-	-	-
	LS55..	55A	55A	55A	55A	43A	36A	17A	10A	-	-	-	-
2 poles in series + 2 parallel 	LS16 ..	29A	29A	22A	17A	16A	10A	7A	3A	-	-	-	-
	LS25..	45A	36A	27A	19A	17A	12A	9A	5A	-	-	-	-
	LS32 ..	58A	55A	32A	23A	20A	13A	10A	6A	-	-	-	-
	LS40 ..	72A	68A	49A	42A	31A	29A	11A	7,5A	-	-	-	-
	LS55..	85A	85A	77A	63A	43A	36A	17A	10A	-	-	-	-
4 poles in series 	LS16 ..	16A	16A	16A	16A	16A	16A	16A	16A	16A	16A	11,5A	8A
	LS25..	25A	25A	25A	25A	25A	25A	25A	25A	25A	25A	12A	9A
	LS32 ..	32A	32A	32A	32A	32A	32A	32A	32A	32A	32A	27,5A	10A
	LS40 ..	40A	40A	40A	40A	40A	40A	40A	40A	40A	40A	-	-
	LS55..	55A	55A	55A	55A	55A	55A	55A	55A	55A	55A	-	-
4 poles in series + 2 parallel 	LS16 ..	29A	29A	29A	29A	29A	29A	29A	20A	-	-	-	-
	LS25..	45A	45A	45A	45A	45A	45A	45A	26A	-	-	-	-
	LS32 ..	58A	58A	58A	58A	58A	58A	50A	32A	-	-	-	-
	LS40 ..	72A	72A	72A	72A	72A	72A	56A	42A	-	-	-	-
	LS55 ..	85A	85A	85A	85A	85A	85A	65A	55A	-	-	-	-

Switching programs

Type	6-pole	3+2-pole 3 poles in series +2 poles parallel	8-pole	4+2-pole 4 poles in series +2 poles parallel
LS16	...A6	.. A3+2	...A8	.. A4+2
LS25	...A6	.. A3+2	...A8	.. A4+2
LS32	...A6	.. A3+2	...A8	.. A4+2
LS40	...A6	.. A3+2	...A8	.. A4+2
LS55	...A6	.. A3+2	...A8	.. A4+2

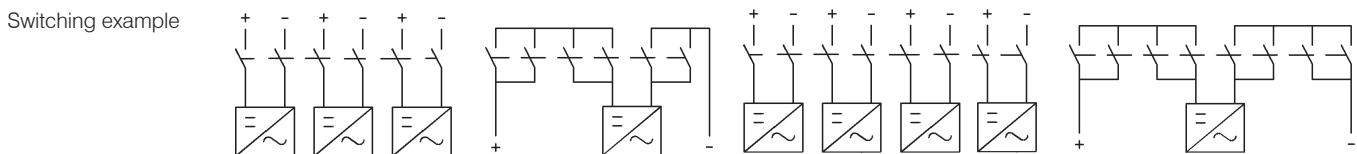
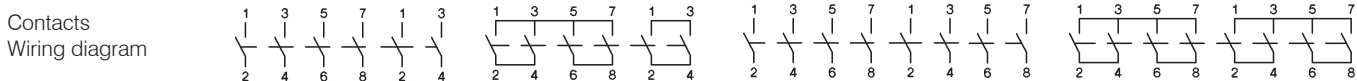

Insulated Jumper LSV.. for series and parallel switching of contacts



Type	Pack	Weight	
LS16, LS25, LS32	LSV-B1	100	6,6 g/pc.
LS40, LS55	LSV-B2	100	9,64 g/pc.

ON-OFF Switches for Panel Mounting, Escutcheon plate 64[□], IP66



	DC21B / DC-PV1 600V DC	1000V DC	Poles in series	Number of Strings	Type	Pack pcs	Weight kg/pcs.
	16A	10A	2	1	LS16 E A2	1	0,20
	25A	11,5A	2	1	LS25 E A2	1	0,20
	32A	13A	2	1	LS32 E A2	1	0,20
	40A	29A	2	1	LS40 E A2	1	0,41
	55A	36A	2	1	LS55 E A2	1	0,41

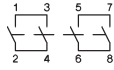

	29A	10A	2	1	LS16 E A2+2	1	0,25
	36A	11,5A	2	1	LS25 E A2+2	1	0,25
	55A	13A	2	1	LS32 E A2+2	1	0,25
	68A	29A	2	1	LS40 E A2+2	1	0,54
	85A	36A	2	1	LS55 E A2+2	1	0,54

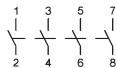

	16A	10A	2	2	LS16 E A4	1	0,23
	25A	11,5A	2	2	LS25 E A4	1	0,23
	32A	13A	2	2	LS32 E A4	1	0,23
	40A	29A	2	2	LS40 E A4	1	0,49
	55A	36A	2	2	LS55 E A4	1	0,49

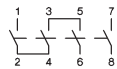

	16A	16A	4	1	LS16 E A4B	1	0,24
	25A	25A	4	1	LS25 E A4B	1	0,24
	32A	32A	4	1	LS32 E A4B	1	0,24
	40A	40A	4	1	LS40 E A4B	1	0,52
	55A	55A	4	1	LS55 E A4B	1	0,52

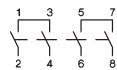

	16A	16A	4	1	LS16 E A4O	1	0,24
	25A	25A	4	1	LS25 E A4O	1	0,24
	32A	32A	4	1	LS32 E A4O	1	0,24
	40A	40A	4	1	LS40 E A4O	1	0,52
	55A	55A	4	1	LS55 E A4O	1	0,52

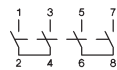

	16A	16A	4	1	LS16 E A4U	1	0,24
	25A	25A	4	1	LS25 E A4U	1	0,24
	32A	32A	4	1	LS32 E A4U	1	0,24
	40A	40A	4	1	LS40 E A4U	1	0,52
	55A	55A	4	1	LS55 E A4U	1	0,52

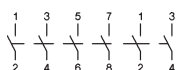

	16A	10A	2	3	LS16 E A6	1	0,36
	25A	11,5A	2	3	LS25 E A6	1	0,36
	32A	13A	2	3	LS32 E A6	1	0,36
	40A	29A	2	3	LS40 E A6	1	0,99
	55A	36A	2	3	LS55 E A6	1	0,99

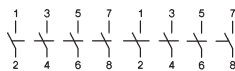

	16A	10A	2	4	LS16 E A8	1	0,41
	25A	11,5A	2	4	LS25 E A8	1	0,41
	32A	13A	2	4	LS32 E A8	1	0,41
	40A	29A	2	4	LS40 E A8	1	1,09
	55A	36A	2	4	LS55 E A8	1	1,09

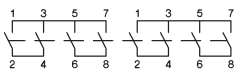

	29A	29A	4	1	LS16 E A4+2	1	0,46
	45A	45A	4	1	LS25 E A4+2	1	0,46
	58A	58A	4	1	LS32 E A4+2	1	0,46
	72A	72A	4	1	LS40 E A4+2	1	1,20
	85A	85A	4	1	LS55 E A4+2	1	1,20

Extended Switch Shaft for all switches for panel mounting

type suffix

+VW“x“

x = panel thickness

ON-OFF Switches for Single Hole Mounting Ø22mm, Escutcheon plate 48², IP66 US Type 4X



DC21B / DC-PV1 600V DC	DC 1000V DC	Poles in series	Number of Strings	Type	Pack pcs	Weight kg/pcs.
16A	10A	2	1	LS16 Z A2	1	0,21
25A	11,5A	2	1	LS25 Z A2	1	0,21
32A	13A	2	1	LS32 Z A2	1	0,21

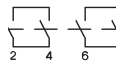

29A	10A	2	1	LS16 Z A2+2	1	0,26
36A	11,5A	2	1	LS25 Z A2+2	1	0,26
55A	13A	2	1	LS32 Z A2+2	1	0,26

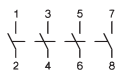

16A	10A	2	2	LS16 Z A4	1	0,23
25A	11,5A	2	2	LS25 Z A4	1	0,23
32A	13A	2	2	LS32 Z A4	1	0,23

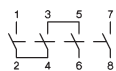

16A	16A	4	1	LS16 Z A4B	1	0,25
25A	25A	4	1	LS25 Z A4B	1	0,25
32A	32A	4	1	LS32 Z A4B	1	0,25

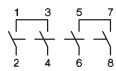

16A	16A	4	1	LS16 Z A4O	1	0,25
25A	25A	4	1	LS25 Z A4O	1	0,25
32A	32A	4	1	LS32 Z A4O	1	0,25

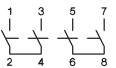

16A	16A	4	1	LS16 Z A4U	1	0,25
25A	25A	4	1	LS25 Z A4U	1	0,25
32A	32A	4	1	LS32 Z A4U	1	0,25

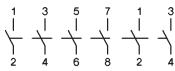

16A	10A	2	3	LS16 Z A6	1	0,38
25A	11,5A	2	3	LS25 Z A6	1	0,38
32A	13A	2	3	LS32 Z A6	1	0,38

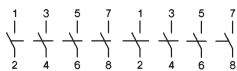

16A	10A	2	4	LS16 Z A8	1	0,43
25A	11,5A	2	4	LS25 Z A8	1	0,43
32A	13A	2	4	LS32 Z A8	1	0,43

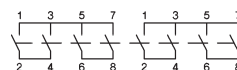

29A	29A	4	1	LS16 Z A4+2	1	0,48
45A	45A	4	1	LS25 Z A4+2	1	0,48
58A	58A	4	1	LS32 Z A4+2	1	0,48

ON-OFF Switches for Single Hole Mounting Ø22mm, without Escutcheon plate, IP66, US Typ 4X



Replace at the Type „Z“ with „ZO“ **LS.. ZO A.**

ON-OFF Switches f. Base Mounting w. Door Clutch f. Single Hole, Plate 64³, IP66,



Depth is adjustable
see page 317

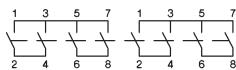
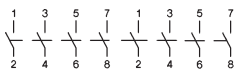
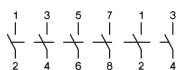
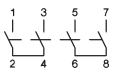
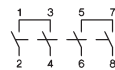
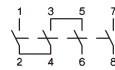
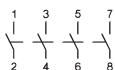
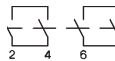

DC21B / DC-PV1 600V DC	1000V DC	Poles in series	Number of Strings	Type	Pack pcs	Weight kg/pcs.
16A	10A	2	1	LS16 VZV A2	1	0,22
25A	11,5A	2	1	LS25 VZV A2	1	0,22
32A	13A	2	1	LS32 VZV A2	1	0,22
40A	29A	2	1	LS40 VZV A2	1	0,51
55A	36A	2	1	LS55 VZV A2	1	0,51
29A	10A	2	1	LS16 VZV A2+2	1	0,27
36A	11,5A	2	1	LS25 VZV A2+2	1	0,27
55A	13A	2	1	LS32 VZV A2+2	1	0,27
68A	29A	2	1	LS40 VZV A2+2	1	0,55
85A	36A	2	1	LS55 VZV A2+2	1	0,55
16A	10A	2	2	LS16 VZV A4	1	0,25
25A	11,5A	2	2	LS25 VZV A4	1	0,25
32A	13A	2	2	LS32 VZV A4	1	0,25
40A	29A	2	2	LS40 VZV A4	1	0,56
55A	36A	2	2	LS55 VZV A4	1	0,56
16A	16A	4	1	LS16 VZV A4B	1	0,26
25A	25A	4	1	LS25 VZV A4B	1	0,26
32A	32A	4	1	LS32 VZV A4B	1	0,26
40A	40A	4	1	LS40 VZV A4B	1	0,58
55A	55A	4	1	LS55 VZV A4B	1	0,58
16A	16A	4	1	LS16 VZV A4O	1	0,26
25A	25A	4	1	LS25 VZV A4O	1	0,26
32A	32A	4	1	LS32 VZV A4O	1	0,26
40A	40A	4	1	LS40 VZV A4O	1	0,58
55A	55A	4	1	LS55 VZV A4O	1	0,58
16A	16A	4	1	LS16 VZV A4U	1	0,26
25A	25A	4	1	LS25 VZV A4U	1	0,26
32A	32A	4	1	LS32 VZV A4U	1	0,26
40A	40A	4	1	LS40 VZV A4U	1	0,58
55A	55A	4	1	LS55 VZV A4U	1	0,58
16A	10A	2	3	LS16 VZV A6	1	0,38
25A	11,5A	2	3	LS25 VZV A6	1	0,38
32A	13A	2	3	LS32 VZV A6	1	0,38
40A	29A	2	3	LS40 VZV A6	1	1,00
55A	36A	2	3	LS55 VZV A6	1	1,00
16A	10A	2	4	LS16 VZV A8	1	0,43
25A	11,5A	2	4	LS25 VZV A8	1	0,43
32A	13A	2	4	LS32 VZV A8	1	0,43
40A	29A	2	4	LS40 VZV A8	1	1,10
55A	36A	2	4	LS55 VZV A8	1	1,10
29A	29A	4	1	LS16 VZV A4+2	1	0,48
45A	45A	4	1	LS25 VZV A4+2	1	0,48
58A	58A	4	1	LS32 VZV A4+2	1	0,48
72A	72A	4	1	LS40 VZV A4+2	1	1,21
85A	85A	4	1	LS55 VZV A4+2	1	1,21

ON-OFF Switches for Distribution Boards, IP40, Open Type



DC21B / DC-PV1 600V DC	1000V DC	Poles in series	Number of Strings	Type	Pack pcs	Weight kg/pcs.
16A	10A	2	1	LS16 SMA A2	1	0,19
25A	11,5A	2	1	LS25 SMA A2	1	0,19
32A	13A	2	1	LS32 SMA A2	1	0,19
40A	29A	2	1	LS40 SMA A2	1	0,41
55A	36A	2	1	LS55 SMA A2	1	0,41

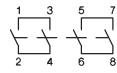

29A	10A	2	1	LS16 SMA A2+2	1	0,24
36A	11,5A	2	1	LS25 SMA A2+2	1	0,24
55A	13A	2	1	LS32 SMA A2+2	1	0,24
68A	29A	2	1	LS40 SMA A2+2	1	0,52
85A	36A	2	1	LS55 SMA A2+2	1	0,52

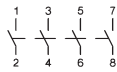

16A	10A	2	2	LS16 SMA A4	1	0,22
25A	11,5A	2	2	LS25 SMA A4	1	0,22
32A	13A	2	2	LS32 SMA A4	1	0,22
40A	29A	2	2	LS40 SMA A4	1	0,45
55A	36A	2	2	LS55 SMA A4	1	0,45

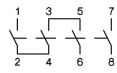

16A	16A	4	1	LS16 SMA A4B	1	0,23
25A	25A	4	1	LS25 SMA A4B	1	0,23
32A	32A	4	1	LS32 SMA A4B	1	0,23
40A	40A	4	1	LS40 SMA A4B	1	0,49
55A	55A	4	1	LS55 SMA A4B	1	0,49

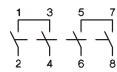

16A	16A	4	1	LS16 SMA A4O	1	0,23
25A	25A	4	1	LS25 SMA A4O	1	0,23
32A	32A	4	1	LS32 SMA A4O	1	0,23
40A	40A	4	1	LS40 SMA A4B	1	0,49
55A	55A	4	1	LS55 SMA A4B	1	0,49

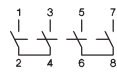

16A	16A	4	1	LS16 SMA A4U	1	0,23
25A	25A	4	1	LS25 SMA A4U	1	0,23
32A	32A	4	1	LS32 SMA A4U	1	0,23
40A	40A	4	1	LS40 SMA A4B	1	0,49
55A	55A	4	1	LS55 SMA A4B	1	0,49

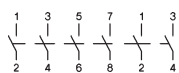

16A	10A	2	3	LS16 SMA A6	1	0,35
25A	11,5A	2	3	LS25 SMA A6	1	0,35
32A	13A	2	3	LS32 SMA A6	1	0,35
40A	29A	2	3	LS40 SMA A6	1	0,89
55A	36A	2	3	LS55 SMA A6	1	0,89

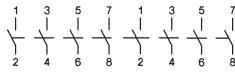

16A	10A	2	4	LS16 SMA A8	1	0,40
25A	11,5A	2	4	LS25 SMA A8	1	0,40
32A	13A	2	4	LS32 SMA A8	1	0,40
40A	29A	2	4	LS40 SMA A8	1	0,99
55A	36A	2	4	LS55 SMA A8	1	0,99

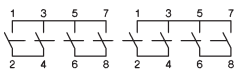

29A	29A	4	1	LS16 SMA A4+2	1	0,43
45A	45A	4	1	LS25 SMA A4+2	1	0,43
58A	58A	4	1	LS32 SMA A4+2	1	0,43
72A	72A	4	1	LS40 SMA A4+2	1	1,01
85A	85A	4	1	LS55 SMA A4+2	1	1,01

Main Switches for Panel Mounting, Escutcheon plate 64[□], IP66, US Type 4X



padlock device SV4



DC21B / DC-PV1 600V DC	DC 1000V DC	Poles in series	Number of Strings	Type	Pack pcs	Weight kg/pcs.
16A	10A	2	1	LS16 EH4 A2	1	0,21
25A	11,5A	2	1	LS25 EH4 A2	1	0,21
32A	13A	2	1	LS32 EH4 A2	1	0,21
40A	29A	2	1	LS40 EH4 A2	1	0,43
55A	36A	2	1	LS55 EH4 A2	1	0,43

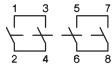

29A	10A	2	1	LS16 EH4 A2+2	1	0,26
36A	11,5A	2	1	LS25 EH4 A2+2	1	0,26
55A	13A	2	1	LS32 EH4 A2+2	1	0,26
68A	29A	2	1	LS40 EH4 A2+2	1	0,57
85A	36A	2	1	LS55 EH4 A2+2	1	0,57

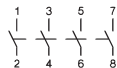

16A	16A	2	2	LS16 EH4 A4	1	0,24
25A	25A	2	2	LS25 EH4 A4	1	0,24
32A	32A	2	2	LS32 EH4 A4	1	0,24
40A	40A	2	2	LS40 EH4 A4	1	0,50
55A	55A	2	2	LS55 EH4 A4	1	0,50

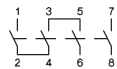

16A	10A	4	1	LS16 EH4 A4B	1	0,25
25A	11,5A	4	1	LS25 EH4 A4B	1	0,25
32A	13A	4	1	LS32 EH4 A4B	1	0,25
40A	29A	4	1	LS40 EH4 A4B	1	0,53
55A	36A	4	1	LS55 EH4 A4B	1	0,53

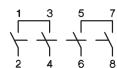

16A	16A	4	1	LS16 EH4 A4O	1	0,25
25A	25A	4	1	LS25 EH4 A4O	1	0,25
32A	32A	4	1	LS32 EH4 A4O	1	0,25
40A	40A	4	1	LS40 EH4 A4O	1	0,53
55A	55A	4	1	LS55 EH4 A4O	1	0,53

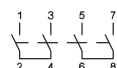

16A	16A	4	1	LS16 EH4 A4U	1	0,25
25A	25A	4	1	LS25 EH4 A4U	1	0,25
32A	32A	4	1	LS32 EH4 A4U	1	0,25
40A	40A	4	1	LS40 EH4 A4U	1	0,53
55A	55A	4	1	LS55 EH4 A4U	1	0,53

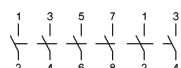

16A	10A	2	3	LS16 EH4 A6	1	0,37
25A	11,5A	2	3	LS25 EH4 A6	1	0,37
32A	13A	2	3	LS32 EH4 A6	1	0,37
40A	29A	2	3	LS40 EH4 A6	1	0,53
55A	36A	2	3	LS55 EH4 A6	1	0,53

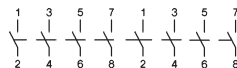

16A	10A	2	4	LS16 EH4 A8	1	0,42
25A	11,5A	2	4	LS25 EH4 A8	1	0,42
32A	13A	2	4	LS32 EH4 A8	1	0,42
40A	29A	2	4	LS40 EH4 A8	1	1,10
55A	36A	2	4	LS55 EH4 A8	1	1,10

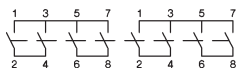

29A	29A	4	1	LS16 EH4 A4+2	1	0,47
45A	45A	4	1	LS25 EH4 A4+2	1	0,47
58A	58A	4	1	LS32 EH4 A4+2	1	0,47
72A	72A	4	1	LS40 EH4 A4+2	1	1,21
85A	85A	4	1	LS55 EH4 A4+2	1	1,21

Extended Switch Shaft for all switches for panel mounting

type suffix

+VW"x"

x = panel thickness

Main Switches for Single Hole Mounting Ø22mm, Escutcheon plate 48³, IP66, c us Type 4X



padlock device SV1



DC21B / DC-PV1 600V DC	DC 1000V DC	Poles in series	Number of Strings	Type	Pack pcs	Weight kg/pcs.
16A	10A	2	1	LS16 ZH1 A2	1	0,21
25A	11,5A	2	1	LS25 ZH1 A2	1	0,21
32A	13A	2	1	LS32 ZH1 A2	1	0,21

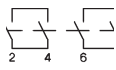

29A	10A	2	1	LS16 ZH1 A2+2	1	0,27
36A	11,5A	2	1	LS25 ZH1 A2+2	1	0,27
55A	13A	2	1	LS32 ZH1 A2+2	1	0,27

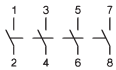

16A	10A	2	2	LS16 ZH1 A4	1	0,24
25A	11,5A	2	2	LS25 ZH1 A4	1	0,24
32A	13A	2	2	LS32 ZH1 A4	1	0,24

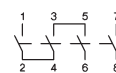

16A	16A	4	1	LS16 ZH1 A4B	1	0,25
25A	25A	4	1	LS25 ZH1 A4B	1	0,25
32A	32A	4	1	LS32 ZH1 A4B	1	0,25

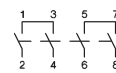

16A	16A	4	1	LS16 ZH1 A4O	1	0,25
25A	25A	4	1	LS25 ZH1 A4O	1	0,25
32A	32A	4	1	LS32 ZH1 A4O	1	0,25

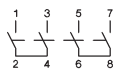

16A	16A	4	1	LS16 ZH1 A4U	1	0,25
25A	25A	4	1	LS25 ZH1 A4U	1	0,25
32A	32A	4	1	LS32 ZH1 A4U	1	0,25

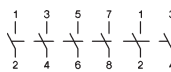

16A	10A	2	3	LS16 ZH1 A6	1	0,39
25A	11,5A	2	3	LS25 ZH1 A6	1	0,39
32A	13A	2	3	LS32 ZH1 A6	1	0,39

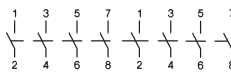

16A	10A	2	4	LS16 ZH1 A8	1	0,44
25A	11,5A	2	4	LS25 ZH1 A8	1	0,44
32A	13A	2	4	LS32 ZH1 A8	1	0,44

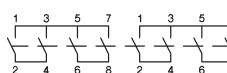

29A	29A	4	1	LS16 ZH1 A4+2	1	0,49
45A	45A	4	1	LS25 ZH1 A4+2	1	0,49
58A	58A	4	1	LS32 ZH1 A4+2	1	0,49

Main Switches f. Base Mounting, Door Clutch f. Single Hole, Escutcheon plate 64[□], IP66,



DC21B / DC-PV1 600V DC 1000V DC	Poles in series	Number of Strings	Type	Pack pcs	Weight kg/pcs.
16A 10A	2	1	LS16 VZVH4 A2	1	0,23
25A 11,5A	2	1	LS25 VZVH4 A2	1	0,23
32A 13A	2	1	LS32 VZVH4 A2	1	0,23
40A 29A	2	1	LS40 VZVH4 A2	1	0,51
55A 36A	2	1	LS55 VZVH4 A2	1	0,51

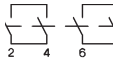

29A 10A	2	1	LS16 VZVH4 A2+2	1	0,28
36A 11,5A	2	1	LS25 VZVH4 A2+2	1	0,28
55A 13A	2	1	LS32 VZVH4 A2+2	1	0,28
68A 29A	2	1	LS40 VZVH4 A2+2	1	0,65
85A 36A	2	1	LS55 VZVH4 A2+2	1	0,65

Depth is adjustable
see page 317
padlock device SV4

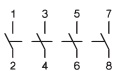

16A 10A	2	2	LS16 VZVH4 A4	1	0,26
25A 11,5A	2	2	LS25 VZVH4 A4	1	0,26
32A 13A	2	2	LS32 VZVH4 A4	1	0,26
40A 29A	2	2	LS40 VZVH4 A4	1	0,58
55A 36A	2	2	LS55 VZVH4 A4	1	0,58

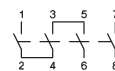

16A 16A	4	1	LS16 VZVH4 A4B	1	0,27
25A 25A	4	1	LS25 VZVH4 A4B	1	0,27
32A 32A	4	1	LS32 VZVH4 A4B	1	0,27
40A 40A	4	1	LS40 VZVH4 A4B	1	0,62
55A 55A	4	1	LS55 VZVH4 A4B	1	0,62

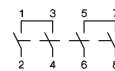

16A 16A	4	1	LS16 VZVH4 A4O	1	0,27
25A 25A	4	1	LS25 VZVH4 A4O	1	0,27
32A 32A	4	1	LS32 VZVH4 A4O	1	0,27
40A 40A	4	1	LS40 VZVH4 A4O	1	0,62
55A 55A	4	1	LS55 VZVH4 A4O	1	0,62

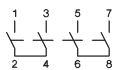

16A 16A	4	1	LS16 VZVH4 A4U	1	0,27
25A 25A	4	1	LS25 VZVH4 A4U	1	0,27
32A 32A	4	1	LS32 VZVH4 A4U	1	0,27
40A 40A	4	1	LS40 VZVH4 A4U	1	0,62
55A 55A	4	1	LS55 VZVH4 A4U	1	0,62

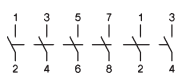

16A 10A	2	3	LS16 VZVH4 A6	1	0,39
25A 11,5A	2	3	LS25 VZVH4 A6	1	0,39
32A 13A	2	3	LS32 VZVH4 A6	1	0,39
40A 29A	2	3	LS40 VZVH4 A6	1	1,00
55A 36A	2	3	LS55 VZVH4 A6	1	1,00

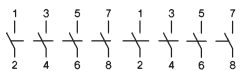



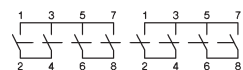



16A 10A	2	4	LS16 VZVH4 A8	1	0,44
25A 11,5A	2	4	LS25 VZVH4 A8	1	0,44
32A 13A	2	4	LS32 VZVH4 A8	1	0,44
40A 29A	2	4	LS40 VZVH4 A8	1	1,11
55A 36A	2	4	LS55 VZVH4 A8	1	1,11

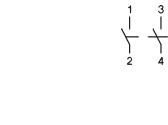

29A 29A	4	1	LS16 VZVH4 A4+2	1	0,49
45A 45A	4	1	LS25 VZVH4 A4+2	1	0,49
58A 58A	4	1	LS32 VZVH4 A4+2	1	0,49
72A 72A	4	1	LS40 VZVH4 A4+2	1	1,22
85A 85A	4	1	LS55 VZVH4 A4+2	1	1,22

Main Switches for Distribution Boards, IP40, Open Type

	DC21B / DC-PV1 600V DC	1000V DC	Poles in series	Number of Strings	Type	Pack pcs	Weight kg/pcs.
	16A	10A	2	1	LS16 SMAH1 A2	1	0,19
	25A	11,5A	2	1	LS25 SMAH1 A2	1	0,19
	32A	13A	2	1	LS32 SMAH1 A2	1	0,19
	40A	29A	2	1	LS40 SMAH1 A2	1	0,40
	55A	36A	2	1	LS55 SMAH1 A2	1	0,40
padlock device SV1 	29A	10A	2	1	LS16 SMAH1 A2+2 ¹⁾	1	0,25
	36A	11,5A	2	1	LS25 SMAH1 A2+2 ¹⁾	1	0,25
	55A	13A	2	1	LS32 SMAH1 A2+2 ¹⁾	1	0,25
	68A	29A	2	1	LS40 SMAH1 A2+2	1	0,54
	85A	36A	2	1	LS55 SMAH1 A2+2	1	0,54
	16A	10A	2	2	LS16 SMAH1 A4 ¹⁾	1	0,22
	25A	11,5A	2	2	LS25 SMAH1 A4 ¹⁾	1	0,22
	32A	13A	2	2	LS32 SMAH1 A4 ¹⁾	1	0,22
	40A	29A	2	2	LS40 SMAH1 A4	1	0,47
	55A	36A	2	2	LS55 SMAH1 A4	1	0,47
	16A	16A	4	1	LS16 SMAH1 A4B ¹⁾	1	0,23
	25A	25A	4	1	LS25 SMAH1 A4B ¹⁾	1	0,23
	32A	32A	4	1	LS32 SMAH1 A4B ¹⁾	1	0,23
	40A	40A	4	1	LS40 SMAH1 A4B	1	0,50
	55A	55A	4	1	LS55 SMAH1 A4B	1	0,50
	16A	16A	4	1	LS16 SMAH1 A4O ¹⁾	1	0,23
	25A	25A	4	1	LS25 SMAH1 A4O ¹⁾	1	0,23
	32A	32A	4	1	LS32 SMAH1 A4O ¹⁾	1	0,23
	40A	40A	4	1	LS40 SMAH1 A4B	1	0,50
	55A	55A	4	1	LS55 SMAH1 A4B	1	0,50
	16A	16A	4	1	LS16 SMAH1 A4U ¹⁾	1	0,23
	25A	25A	4	1	LS25 SMAH1 A4U ¹⁾	1	0,23
	32A	32A	4	1	LS32 SMAH1 A4U ¹⁾	1	0,23
	40A	40A	4	1	LS40 SMAH1 A4B	1	0,50
	55A	55A	4	1	LS55 SMAH1 A4B	1	0,50
	16A	10A	2	3	LS16 SMAH1 A6	1	0,36
	25A	11,5A	2	3	LS25 SMAH1 A6	1	0,36
	32A	13A	2	3	LS32 SMAH1 A6	1	0,36
	40A	29A	2	3	LS40 SMAH1 A6	1	0,90
	55A	36A	2	3	LS55 SMAH1 A6	1	0,90
	16A	10A	2	4	LS16 SMAH1 A8	1	0,41
	25A	11,5A	2	4	LS25 SMAH1 A8	1	0,41
	32A	13A	2	4	LS32 SMAH1 A8	1	0,41
	40A	29A	2	4	LS32 SMAH1 A8	1	0,41
	55A	36A	2	4	LS32 SMAH1 A8	1	0,41
	29A	29A	4	1	LS16 SMAH1 A4+2	1	0,46
	45A	45A	4	1	LS25 SMAH1 A4+2	1	0,46
	58A	58A	4	1	LS32 SMAH1 A4+2	1	0,46
	72A	72A	4	1	LS40 SMAH1 A4+2	1	1,12
	85A	85A	4	1	LS55 SMAH1 A4+2	1	1,12

¹⁾ Main Switches for Distribution Boards with low height handle, IP40,   Open Type

Type with Type-suffix „+SV1N“ e.g. **LS.. SMAH1 A2+2 +SV1N**

Main Switches in Plastic Enclosure, Escutcheon plate 64[□], IP66, Type 4X



padlock device SV4



DC21B / DC-PV1 600V DC	1000V DC	Poles in series	Number of Strings	Type	Pack pcs	Weight kg/pcs.
16A	10A	2	1	LS16 PFLH4 A2 ¹⁾	1	0,43
25A	11,5A	2	1	LS25 PFLH4 A2 ¹⁾	1	0,43
32A	13A	2	1	LS32 PFLH4 A2 ¹⁾	1	0,43
40A	29A	2	1	LS40 PFLH4 A2	1	1,59
55A	36A	2	1	LS55 PFLH4 A2	1	1,59

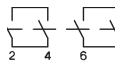

29A	10A	2	1	LS16 PFLH4 A2+2 ¹⁾	1	0,49
36A	11,5A	2	1	LS25 PFLH4 A2+2 ¹⁾	1	0,49
55A	13A	2	1	LS32 PFLH4 A2+2 ¹⁾	1	0,49
68A	29A	2	1	LS40 PFLH4 A2+2	1	1,74
85A	36A	2	1	LS55 PFLH4 A2+2	1	1,74

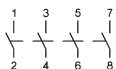

16A	10A	2	2	LS16 PFLH4 A4 ¹⁾	1	0,46
25A	11,5A	2	2	LS25 PFLH4 A4 ¹⁾	1	0,46
32A	13A	2	2	LS32 PFLH4 A4 ¹⁾	1	0,46
40A	29A	2	2	LS40 PFLH4 A4	1	1,67
55A	36A	2	2	LS55 PFLH4 A4	1	1,67

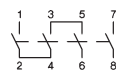

16A	16A	4	1	LS16 PFLH4 A4B ¹⁾	1	0,47
25A	25A	4	1	LS25 PFLH4 A4B ¹⁾	1	0,47
32A	32A	4	1	LS32 PFLH4 A4B ¹⁾	1	0,47
40A	40A	4	1	LS40 PFLH4 A4B	1	1,70
55A	55A	4	1	LS55 PFLH4 A4B	1	1,70

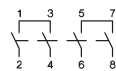

16A	16A	4	1	LS16 PFLH4 A4O ¹⁾	1	0,47
25A	25A	4	1	LS25 PFLH4 A4O ¹⁾	1	0,47
32A	32A	4	1	LS32 PFLH4 A4O ¹⁾	1	0,47
40A	40A	4	1	LS40 PFLH4 A4O	1	1,70
55A	55A	4	1	LS55 PFLH4 A4O	1	1,70

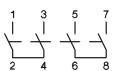

16A	16A	4	1	LS16 PFLH4 A4U ¹⁾	1	0,47
25A	25A	4	1	LS25 PFLH4 A4U ¹⁾	1	0,47
32A	32A	4	1	LS32 PFLH4 A4U ¹⁾	1	0,47
40A	40A	4	1	LS40 PFLH4 A4U	1	1,70
55A	55A	4	1	LS55 PFLH4 A4U	1	1,70

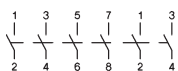

16A	10A	2	3	LS16 PFLH4 A6	1	1,53
25A	11,5A	2	3	LS25 PFLH4 A6	1	1,53
32A	13A	2	3	LS32 PFLH4 A6	1	1,53
40A	29A	2	3	LS40 PFLH4 A6	1	1,87
55A	36A	2	3	LS55 PFLH4 A6	1	1,87

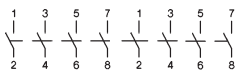

16A	10A	2	4	LS16 PFLH4 A8	1	1,58
25A	11,5A	2	4	LS25 PFLH4 A8	1	1,58
32A	13A	2	4	LS32 PFLH4 A8	1	1,58
40A	29A	2	4	LS40 PFLH4 A8	1	1,94
55A	36A	2	4	LS55 PFLH4 A8	1	1,94

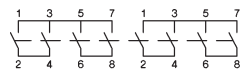

29A	29A	4	1	LS16 PFLH4 A4+2	1	1,63
45A	45A	4	1	LS25 PFLH4 A4+2	1	1,63
58A	58A	4	1	LS32 PFLH4 A4+2	1	1,63
72A	72A	4	1	LS40 PFLH4 A4+2	1	2,07
85A	85A	4	1	LS55 PFLH4 A4+2	1	2,07

Technical Data

Kind of current	Category	Typical applications	Test conditions for the number of on-load operating cycles (normal service)						Test conditions for making and breaking capacities (operation in fault case)											
			Make		U/U _e		L/R		Make		U/U _e		L/R							
			I/le	U/U _e	L/R	Break I _c /le	U _r /U _e	L/R	I/le	U/U _e	L/R	Break I _c /le	U _r /U _e	L/R						
Direct current	DC21A frequent operation	DC21B infrequent operation	Switching of resistive loads including moderate overloads						1	1	1ms	1	1	1ms	1,5	1,05	1ms	1,5	1,05	1ms
	DC22A frequent operation	DC22B infrequent operation	Switching of mixed resistive a.induct. loads incl. moderate overloads (shunt motors)						1	1	2ms	1	1	2ms	4	1,05	2,5ms	4	1,05	2,5ms
	DC-PV1		Switching of single PV string(s) without reverse- and overcurrents.						1	1	1ms	1	1	1ms	1,5	1,05	1ms	1,5	1,05	1ms
	DC-PV2		Switching of several PV strings with reverse- and overcurrents.						1	1	1ms	1	1	1ms	4	1,05	1ms	4	1,05	1ms





Data according to IEC 60947-3, VDE 0660, GB14048.3 (CCC China)

Main contacts		Type	LS16	LS25	LS32	LS40	LS55	
Rated thermal current I _{the}		A	16	25	32	40	55	
Rated insulation voltage U _i ¹⁾		V	1000	1000	1000	1500	1500	
Rated insulation voltage U _i ²⁾		V	1500	1500	1500	1500	1500	
Distance of contacts (per pole)		mm	8	8	8			
Rated operational current I_e								
DC21A and DC21B	1 pole	300V A	16	23	27	40	55	
		400V A	12	14	16	30	40	
DC21B	A1	500V A	9	11	13	19	25	
		600V A	6	8	10	15	20	
	1	700V A	4,5	6	7,5	10	15	
		800V A	3	4	5	8	10	
	2 pole in series	500V A	16	25	32	40	55	
		600V A	16	25	32	40	55	
	A2	700V A	16	23	27	35	55	
		800V A	16	20	23	30	45	
	1 2	900V A	13	16	20	25	35	
		1000V A	9	11	13	20	36	
2 poles in series + 2 poles parallel	500V A	29	45	58	72	85		
	600V A	29	45	50	64	80		
A2+2	700V A	16	23	27	35	55		
	800V A	16	20	23	30	45		
1 2 3 4	900V A	13	16	20	25	35		
	1000V A	9	11	13	20	25		
1200V A	6	8	10	10	15			
	1500V A	3	4	5	6	7,5		
3 poles in series + 2 poles parallel	500V A	29	45	58	72	85		
	600V A	29	45	50	72	85		
A3+2	700V A	29	38	45	72	85		
	800V A	29	38	45	68	85		
1 2 3 4 5 6	900V A	29	38	45	62	78		
	1000V A	29	38	45	58	70		
1200V A	12	14	16	-	-			
	1500V A	9	11	13	-	-		
4 poles in series	500V A	16	25	32	40	55		
	600V A	16	25	32	40	55		
A4	700V A	16	25	32	40	55		
	800V A	16	25	32	40	55		
1 2 3 4	900V A	16	25	32	40	55		
	1000V A	16	25	32	40	55		
1200V A	16	25	32	40	55			
	1500V A	16	20	23	30	40		
4 poles in series + 2 poles parallel	500V A	29	45	58	72	85		
	600V A	29	45	58	72	85		
A4+2	700V A	29	45	58	72	85		
	800V A	29	45	58	72	85		
1 2 3 4 5 6 7 8	900V A	29	45	58	72	85		
	1000V A	29	45	58	72	85		
1200V A	29	45	50	56	65			
	1500V A	16	20	23	42	55		
Rated operational current I_e								
AC21B	A2, A4	U _e max. 440V	A	16	25	32	40	55
	A2+2	U _e max. 440V	A	29	45	58	72	85

1) Suitable at overvoltage category I to III, pollution degree 3 (standard-industry): U_{imp} = 8kV.
 2) Suitable at overvoltage category I to III, pollution degree 2 (min. IP55): U_{imp} = 8kV.

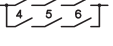

Technical Data

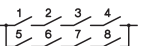
Data according to IEC 60947-3, VDE 0660

Main contacts		Type	LS16	LS25	LS32	LS40	LS55	
Rated operational current I_e DC-PV1	300V	A	16	23	27	40	55	
	400V	A	14	22	25	33	44	
1 pole A1 	500V	A	10	17	20	24	32	
	600V	A	7	12	15	19	25	
	700V	A	5	6	7	12	18	
	800V	A	3	4	5	10	13	
	900V	A	3	3	4	8	10	
	1000V	A	2	2	3	5	8	
	2 poles in series A2 	500V	A	16	25	32	40	55
600V		A	16	25	32	40	55	
700V		A	16	25	32	37	55	
800V		A	16	20	23	35	55	
900V		A	16	17	20	31	43	
1000V		A	10	11,5	13	29	36	
1100V		A	8	10	11,5	19	25	
1200V		A	7	8,5	10	11	17	
1300V		A	6	7	8	10	14	
1400V		A	5	6	7	9	12	
1500V		A	3	5	6	7,5	10	
2 poles in series + 2 poles parallel A2+2 		500V	A	29	45	58	72	85
		600V	A	29	45	55	68	85
	700V	A	22	27	32	49	77	
	800V	A	17	20	23	42	63	
	900V	A	16	17	20	31	43	
	1000V	A	10	11,5	13	29	36	
	1100V	A	8	10	11,5	19	25	
	1200V	A	7	8,5	10	11	17	
	1300V	A	6	7	8	10	14	
	1400V	A	5	6	7	9	12	
	1500V	A	3	5	6	7,5	10	
	3 poles in series + 2 poles parallel A3+2 	500V	A	29	45	58	72	85
		600V	A	29	45	58	72	85
700V		A	29	43	55	72	85	
800V		A	29	40	51	68	85	
900V		A	29	38	47	62	78	
1000V		A	29	38	45	58	70	
1100V		A	19	27	37	-	-	
1200V		A	17	25	28	-	-	
1300V		A	15	21	25	-	-	
1400V		A	12	18	22	-	-	
1500V		A	10	14	20	-	-	
4 poles in series A4 		500V	A	16	25	32	40	55
		600V	A	16	25	32	40	55
	700V	A	16	25	32	40	55	
	800V	A	16	25	32	40	55	
	900V	A	16	25	32	40	55	
	1000V	A	16	25	32	40	55	
	1100V	A	16	25	32	40	55	
	1200V	A	16	25	32	40	55	
	1300V	A	16	25	32	40	55	
	1400V	A	16	25	32	40	55	
	1500V	A	16	25	32	40	55	
	4 poles in series + 2 poles parallel A4+2 	500V	A	29	45	58	72	85
		600V	A	29	45	58	72	85
700V		A	29	45	58	72	85	
800V		A	29	45	58	72	85	
900V		A	29	45	58	72	85	
1000V		A	29	45	58	72	85	
1100V		A	29	45	54	60	68	
1200V		A	29	45	50	56	65	
1300V		A	26	39	44	50	61	
1400V		A	23	33	38	46	58	
1500V		A	20	26	32	42	55	

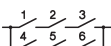
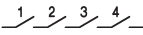
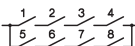

Technical Data

Data according to IEC 60947-3, VDE 0660

Main contacts		Type	LS16	LS25	LS32	LS40	LS55	
Rated operational current I_e DC-PV2	300V	A	16	23	27	40	55	
	400V	A	15	18	20	30	40	
1 pole A1 	500V	A	10	12	14	19	25	
	600V	A	5	6	8	10	13	
	700V	A	1,5	2	3	7	10	
	800V	A	1,5	2	3	6	8	
	900V	A	1	1,5	2	5	6	
	1000V	A	1	1,5	2	3	4	
	2 poles in series A2 	500V	A	16	25	32	40	55
		600V	A	14	21	27	40	55
		700V	A	13	19	22	35	55
		800V	A	12	15	17	33	49
900V		A	8	10	12	25	35	
1000V		A	4	5	6	16	20	
1100V		A	3	4	5	11	15	
1200V		A	2	3	4	8	12	
1300V		A	1,5	2	3	7	10	
1400V		A	1	2	3	7	9	
1500V	A	1	1,5	2	6	8		
2 poles in series + 2 poles parallel A2+2 	500V	A	25	39	50	72	85	
	600V	A	20	32	35	60	75	
	700V	A	13	19	22	38	60	
	800V	A	12	15	17	33	49	
	900V	A	8	10	12	25	35	
	1000V	A	4	5	6	16	25	
	1100V	A	3	4	5	10	15	
	1200V	A	2	3	4	8	12	
	1300V	A	1,5	2	3	7	10	
	1400V	A	1	2	3	7	9	
1500V	A	1	1,5	2	6	8		
3 poles in series + 2 poles parallel A3+2 	500V	A	-	-	-	72	85	
	600V	A	-	-	-	72	78	
	700V	A	-	-	-	62	69	
	800V	A	-	-	-	53	61	
	900V	A	-	-	-	44	55	
	1000V	A	-	-	-	35	50	
	1100V	A	-	-	-	-	-	
	1200V	A	-	-	-	-	-	
	1300V	A	-	-	-	-	-	
	1400V	A	-	-	-	-	-	
1500V	A	-	-	-	-	-		
4 poles in series A4 	500V	A	16	25	32	40	55	
	600V	A	16	25	32	40	55	
	700V	A	16	25	32	40	55	
	800V	A	16	25	32	40	55	
	900V	A	16	25	32	40	55	
	1000V	A	16	25	32	40	55	
	1100V	A	16	25	32	40	55	
	1200V	A	13,5	21	27	40	55	
	1300V	A	12	19	24	36	50	
	1400V	A	10,5	16	21	33	45	
1500V	A	9	14	18	30	40		
4 poles in series + 2 poles parallel A4+2 	500V	A	-	-	-	72	85	
	600V	A	-	-	-	72	85	
	700V	A	-	-	-	72	80	
	800V	A	-	-	-	67	75	
	900V	A	-	-	-	59	70	
	1000V	A	-	-	-	52	64	
	1100V	A	-	-	-	44	59	
	1200V	A	-	-	-	40	55	
	1300V	A	-	-	-	36	50	
	1400V	A	-	-	-	33	45	
1500V	A	-	-	-	30	40		

Technical Data



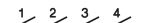



Data according to IEC 60947-3, VDE 0660

Main contacts		Type	LS16	LS25	LS32	LS40	LS55
Rated operational current I_e	500V	A	1	1,25	1,5	x	2,5
DC22B	600V	A	0,5	0,75	1	x	2,0
1 pole	800V	A	0,3	0,4	0,5	x	1,5
A1							
	1000V	A	0,15	0,2	0,25	x	1,0
	1200V	A	-	-	-	x	x
	1500V	A	-	-	-	x	x
2 poles in series	500V	A	7	8	9	x	x
A2	600V	A	5,5	6	6,5	x	x
	800V	A	2	2,5	3	x	x
	1000V	A	1	1,5	2	x	x
	1200V	A	-	-	-	x	x
	1500V	A	-	-	-	x	x
4 poles in series	500V	A	16	25	32	x	x
A4	600V	A	16	25	27,5	x	x
	800V	A	11,5	12	12,5	x	x
	1000V	A	8	9	10	x	x
	1200V	A	-	-	-	x	x
	1500V	A	-	-	-	x	x
Rated conditional short-circuit current		kA _{eff}	5	5	5	10	10
Max. fuse size	gL (gG)	A	40	63	80	125	160
Mechanical life		x10 ³	10	10	10	10	10
Rated short-time withstand current (1s)	lcw	A2, A4, A6, A8	800	900	1000	A2, A4: 1200	A2, A4: 1400
		A2+2, A3+2, A4+2	1300	1500	1700	A2+2: 2000	A2+2: 2400
Short circuit making capacity	lcm	A2, A4, A6, A8	800	900	1000	A2, A4: 1200	A2, A4: 1400
		A2+2, A3+2, A4+2	1300	1500	1700	A2+2: 2000	A2+2: 2400
Maximum cable cross sections (incl. jumper LSV-B1)							
solid or stranded		mm ²	4 - 16	4 - 16	4 - 16	2,5 - 25	2,5 - 25
flexible		mm ²	4 - 10	4 - 10	4 - 10	4 - 16	4 - 16
flexible (+ multicore cable end)		mm ²	4 - 10	4 - 10	4 - 10	2,5 - 16	2,5 - 16
Size of terminal screw			M4 Pz2	M4 Pz2	M4 Pz2	M5 Pz2	M5 Pz2
Tightening torque		Nm	1,7 - 1,8	1,7 - 1,8	1,7 - 1,8	2,5 - 2,8	2,5 - 2,8
2 cables per clamp without jumper LSV-B1 / LSV-B2							
solid or stranded		mm ²	16+(1,5-2,5) / 10+(1,5-6) / 6+(1,5-10) / 4+(1,5-10)			16+(1,5-2,5) / 10+(1,5-10) / 6+(1,5-10) / 4+(1,5-10)	
flexible		mm ²	16+(1,5-2,5) / 10+(1,5-4) / 6+(1,5-6)			16+(1,5-6) / 10+(1,5-10) / 6+(1,5-16) / 4+(1,5-16)	
& flexible + multicore cable end							
stranded		AWG	8+(16-12) / 10+(16-10) / 12+(16-8) 14+(16-8)			3+(18-10) / 4+(18-10) / 6+(18-8) 8+(18-8)	
solid		AWG	10+(16-12) / 12+(16-10) 14+(16-10)			10+(16-10) / 12+(16-10) / 14+(16-10) 12+(16-10) / 14+(16-10)	
Maximum ambient temperature							
Operation	open	°C				-40 to +65	
	enclosed	°C				-40 to +45	
Storage		°C				-50 to +90	
Power loss per switch at I _e max.			A	A	A	A	A
A2	(A)/ W	(16)/ 1	(25)/ 2,3	(32)/ 3,7	(40)/ 4	(55)/ 7,5	
A4	(A)/ W	(16)/ 2	(25)/ 4,6	(32)/ 7,4	(40)/ 8	(55)/ 15	
A6	(A)/ W	(16)/ 3	(25)/ 6,9	(32)/ 11,1	(40)/ 12	(55)/ 22,5	
A8	(A)/ W	(16)/ 4	(25)/ 9,2	(32)/ 14,8	(40)/ 16	(55)/ 30	
A2+2	(A)/ W	(29)/ 1,5	(45)/ 3,7	(58)/ 6	(72)/ 6,5	(85)/ 9	
A3+2	(A)/ W	(29)/ 2,3	(45)/ 5,6	(58)/ 9	(72)/ 9,8	(85)/ 14	
A4+2	(A)/ W	(29)/ 3	(45)/ 7,4	(58)/ 12	(72)/ 13	(85)/ 18	
Contact resistance per pole		mΩ	1,75	1,75	1,75	1,25	1,25

x in test

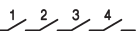
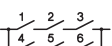
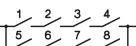





Technical Data

Data according to UL508I  File E359344, Category no.: NMSJ, and UL508 c  File E332938, Category no.: NRNT2, NRNT8

Type			LS16	LS25	LS32	LS40	LS55	
Ampere-Rating "General use" 1 Pol 	DC							
	350V	A	4	5	6	7,1	10,0	
	500V	A	4	5	6	5,7	7,0	
	600V	A	4	5	6	5,0	5,8	
	700V	A	-	-	-	3,9	5,0	
	800V	A	-	-	-	3,2	4,4	
	900V	A	-	-	-	2,5	3,5	
	1000V	A	-	-	-	1,5	2,0	
	2 poles in series A2 	350V	A	16	25	32	40	55
		500V	A	16	25	32	40	55
600V		A	16	25	32	40	55	
700V		A	-	-	-	32	46	
800V		A	-	-	-	26	37	
900V		A	-	-	-	20	28	
1000V		A	-	-	-	16	20	
2 poles in series + 2 poles parallel A2+2 		350V	A	29	45	58	72	85
		400V	A	-	-	-	67	79
		500V	A	29	38	40	53	66
	600V	A	21	27	32	42	55	
	700V	A	-	-	-	35	47	
	800V	A	-	-	-	30	40	
	900V	A	-	-	-	26	32	
	1000V	A	-	-	-	22	25	
	4 poles in series A4 	350V	A	16	25	32	40	55
		500V	A	16	25	32	40	55
600V		A	16	25	32	40	55	
700V		A	-	-	-	40	55	
800V		A	-	-	-	40	55	
900V		A	-	-	-	40	55	
1000V		A	-	-	-	40	55	
3 poles in series + 2 poles parallel A3+2 		350V	A	29	45	58	68	80
		500V	A	29	38	50	56	80
		600V	A	21	38	45	52	65
	700V	A	-	-	-	46	57	
	800V	A	-	-	-	40	55	
	900V	A	-	-	-	36	53	
	1000V	A	-	-	-	33	51	
	4 poles in series + 2 poles parallel A4+2 	350V	A	29	45	58	80	85
		500V	A	29	45	58	71	85
		600V	A	29	45	50	65	82
700V		A	-	-	-	58	76	
800V		A	-	-	-	51	71	
900V		A	-	-	-	45	67	
1000V		A	-	-	-	42	64	
AC-Rating "General use" 2 poles in series 		600V	A	16	25	32	40	55
		277V	A	-	-	50	72	85
		+ 2 poles parallel 						
3 poles parallel 	3x480V	A	-	-	32	-	-	
Fuse size (RK5) Industrial Control Switch 5kA / 600V		A	40	60	80	-	-	
	5KA/1000V	A	-	-	-	160	160	
Maximum cable cross sections (incl. jumper LSV-B1)								
solid or stranded	AWG		12 - 10	12 - 10	12 - 10	16 - 10	16 - 10	
flexible	AWG		12 - 6	12 - 6	12 - 6	14 - 4	14 - 4	
flexible (+ multicore cable end)	AWG		12 - 6	12 - 6	12 - 6			
Size of terminal screw			M4 Pz2	M4 Pz2	M4 Pz2	M5 Pz2	M5 Pz2	
Tightening torque	lb.inch		9 - 16	9 - 16	9 - 16	22 - 25	22 - 25	
Protection class of terminals ¹⁾			IP20	IP20	IP20	IP20	IP20	

1) Protection degree of the terminals with connected insulated conductor.

Approvals

Country	USA, UL508I	US, Canada UL508	Europe	TÜVRheinland	China CCC	CB-Certificates	EAC
Type							
LS16	o	o	/	o	o	o	o
LS25	o	o	/	o	o	o	o
LS32	o	o	/	o	o	o	o
LS40	o	o	/	-	-	o	o
LS55	o	o	/	-	-	o	o

o In standard version approved / No testing required CE x In test - Not provided for test till now

Contactors, Motor-Starters
 Circuit Breakers
 Manual Motor-Starters
 Switches
 AC-Main Switches
 DC-Switch Disconnectors
 Push Buttons
 Representatives, Suppliers

Technical Datas

Maximum current according to ambient temperature and cable cross section

Switch open LS16..., 2 contacts in series (A2)

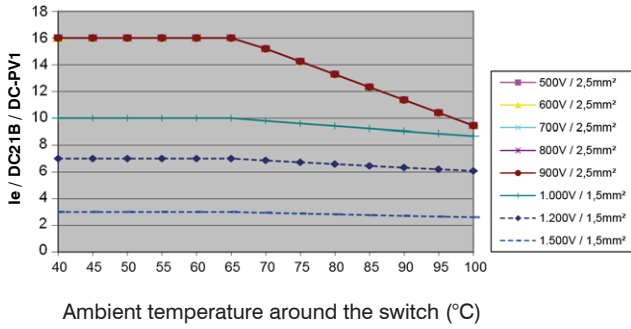

Switch open LS16 ..., 2 contacts in series + 2 parallel (A2+2)

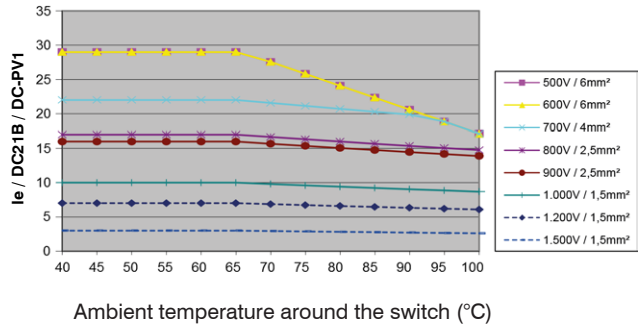

Switch open LS16..., 4 contacts in series (A4x)

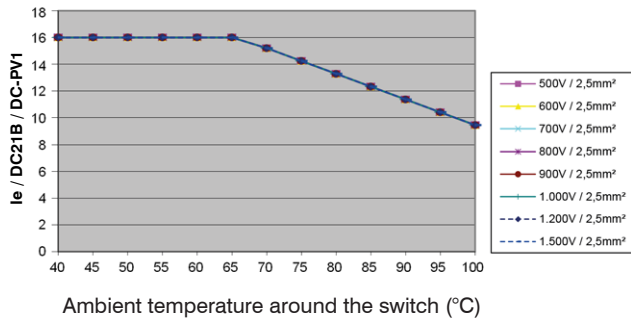

Switch open LS16 ..., 4 contacts in series + 2 parallel (A4+2)

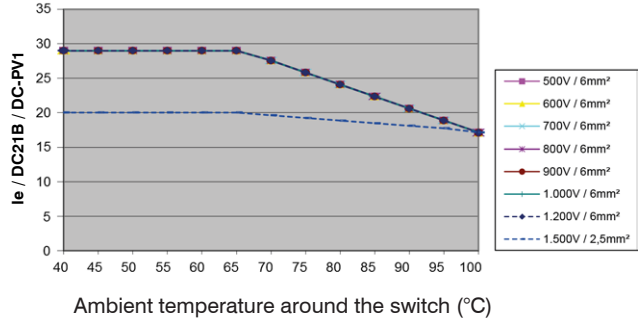

Switch enclosed LS16 PFL..., 2 contacts in series (A2)

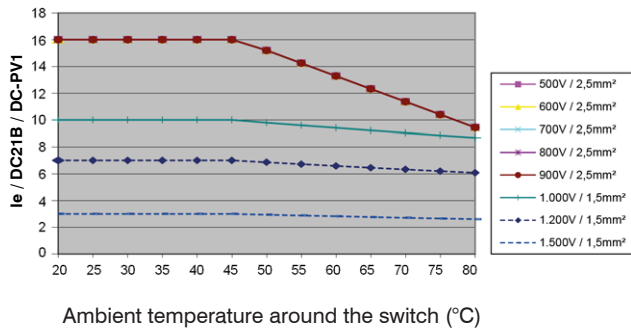

Switch enclosed LS16 PFL..., 2 contacts in series + 2 parallel (A2+2)

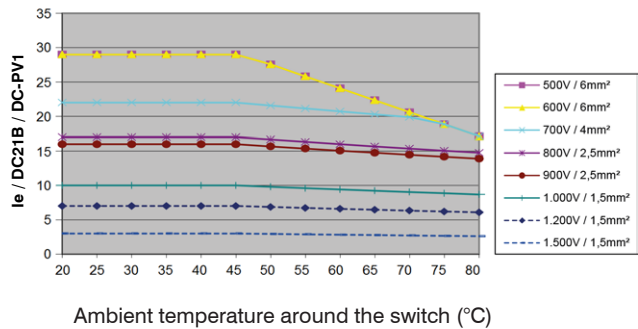

Switch enclosed LS16 PFL..., 4 contacts in series (A4x)

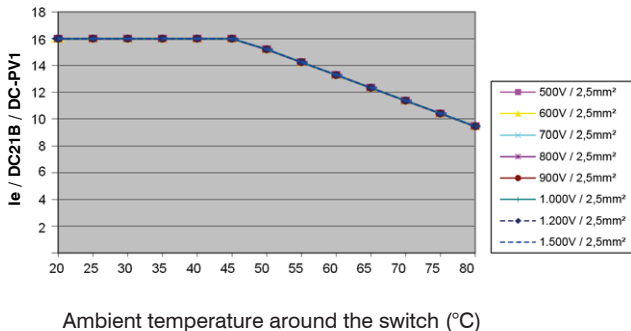

Switch enclosed LS16 PFL..., 4 contacts in series + 2 parallel (A4+2)

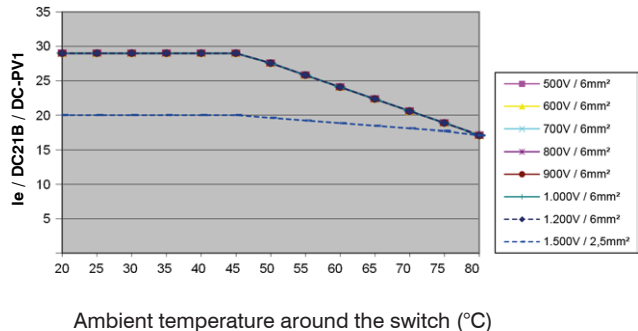

Technical Datas

Maximum current according to ambient temperature and cable cross section

Switch open LS25..., 2 contacts in series (A2)

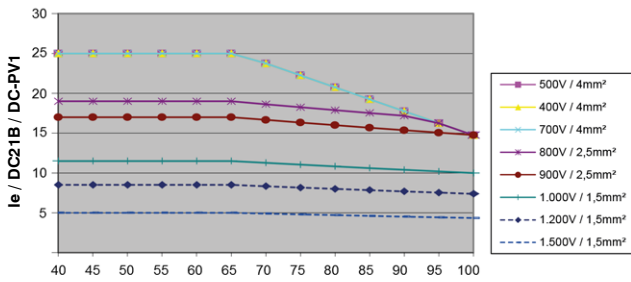

Ambient temperature around the switch (°C)

Switch open LS25 ..., 2 contacts in series + 2 parallel (A2+2)

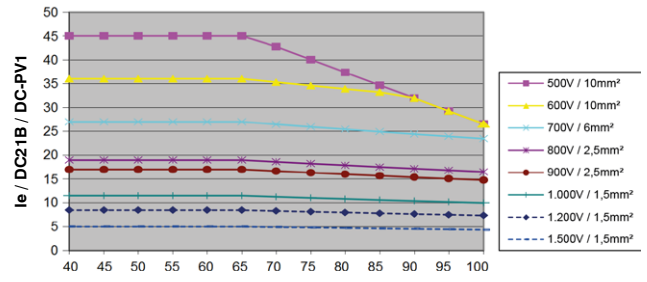

Ambient temperature around the switch (°C)

Switch open LS25..., 4 contacts in series (A4x)

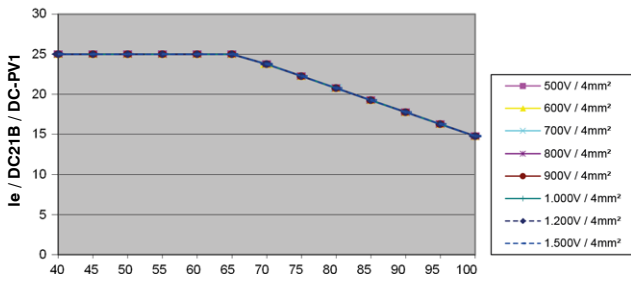

Ambient temperature around the switch (°C)

Switch open LS25 ..., 4 contacts in series + 2 parallel (A4+2)

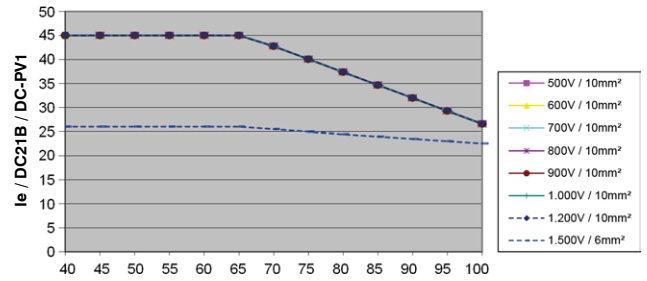

Ambient temperature around the switch (°C)

Switch enclosed LS25 PFL..., 2 contacts in series (A2)

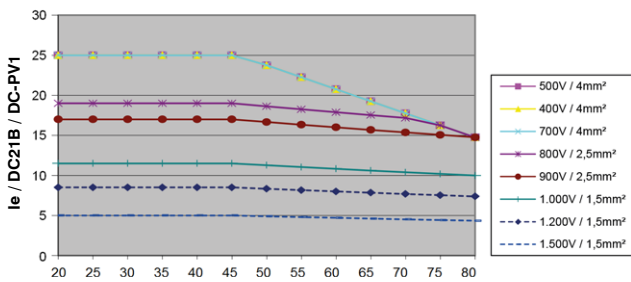

Ambient temperature around the switch (°C)

Switch enclosed LS25 PFL..., 2 contacts in series + 2 parallel (A2+2)

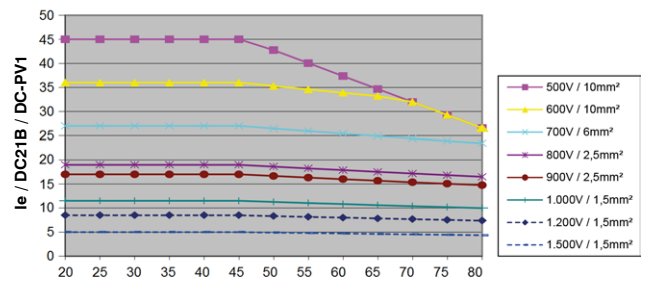

Ambient temperature around the switch (°C)

Switch enclosed LS25 PFL..., 4 contacts in series (A4x)

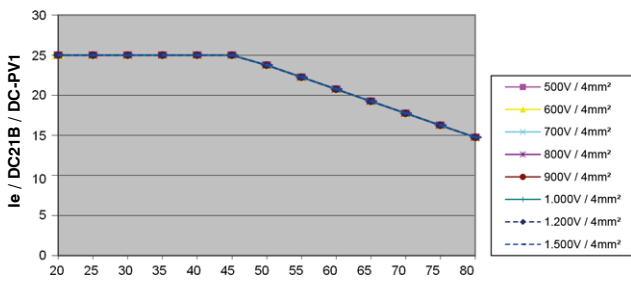

Ambient temperature around the switch (°C)

Switch enclosed LS25 PFL..., 4 contacts in series + 2 parallel (A4+2)

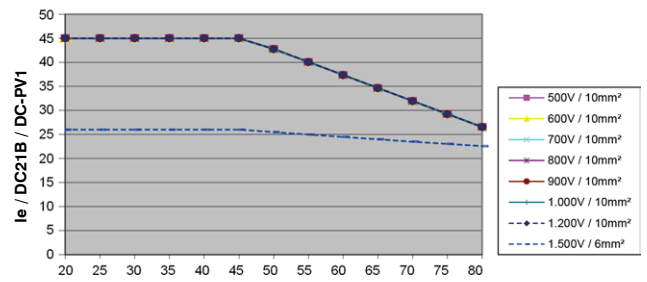

Ambient temperature around the switch (°C)

Technical Datas

Maximum current according to ambient temperature and cable cross section

Switch open LS32..., 2 contacts in series (A2)

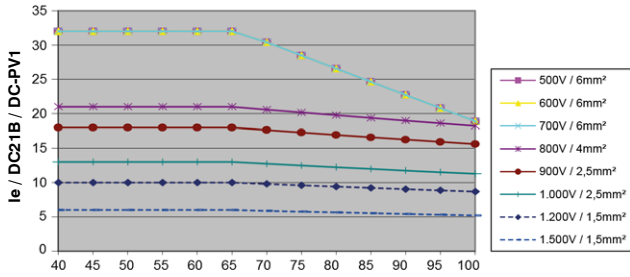

Ambient temperature around the switch (°C)

Switch open LS32 ..., 2 contacts in series + 2 parallel (A2+2)

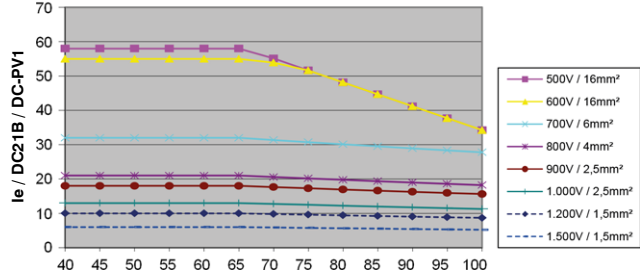

Ambient temperature around the switch (°C)

Switch open LS32..., 4 contacts in series (A4x)

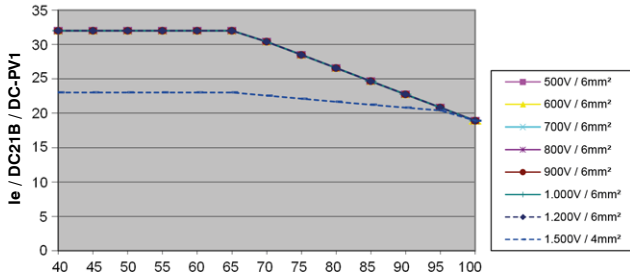

Ambient temperature around the switch (°C)

Switch open LS32 ..., 4 contacts in series + 2 parallel (A4+2)

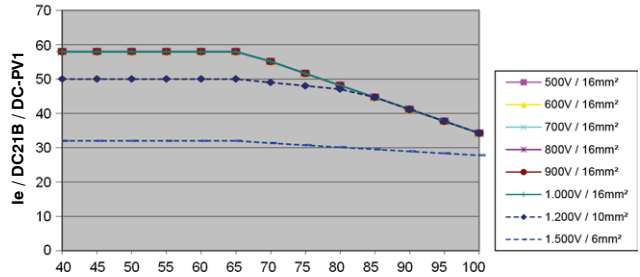

Ambient temperature around the switch (°C)

Switch enclosed LS32 PFL..., 2 contacts in series (A2)

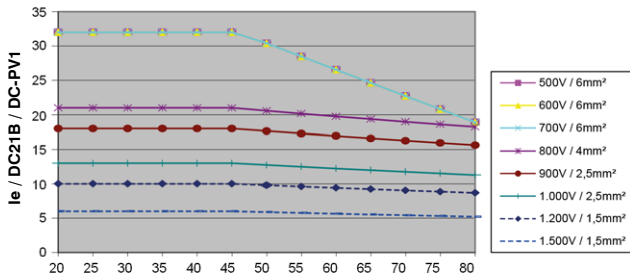

Ambient temperature around the enclosed switch (°C)

Switch enclosed LS32 PFL..., 2 contacts in series + 2 parallel (A2+2)

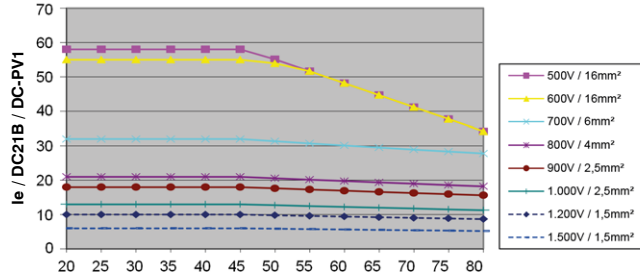

Ambient temperature around the enclosed switch (°C)

Switch enclosed LS32 PFL..., 4 contacts in series (A4x)

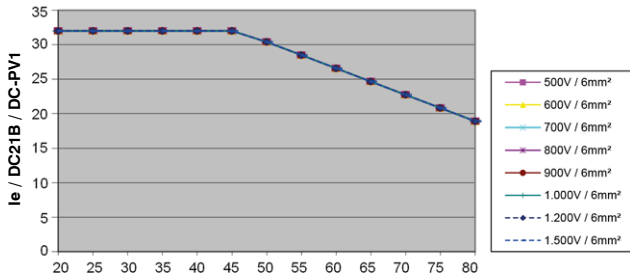

Ambient temperature around the enclosed switch (°C)

Switch enclosed LS32 PFL..., 4 contacts in series + 2 parallel (A4+2)

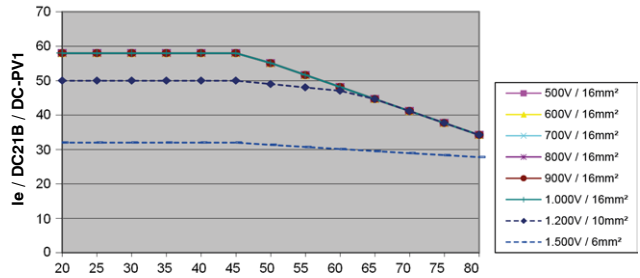

Ambient temperature around the enclosed switch (°C)

Technical Datas

Maximum current according to ambient temperature and cable cross section

Switch open LS40..., 2 contacts in series (A2)

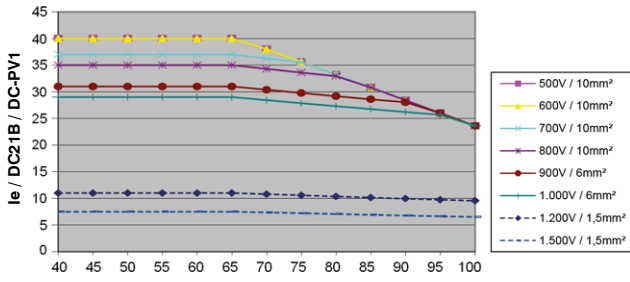

Ambient temperature around the switch (°C)

Switch open LS40 ..., 2 contacts in series + 2 parallel (A2+2)

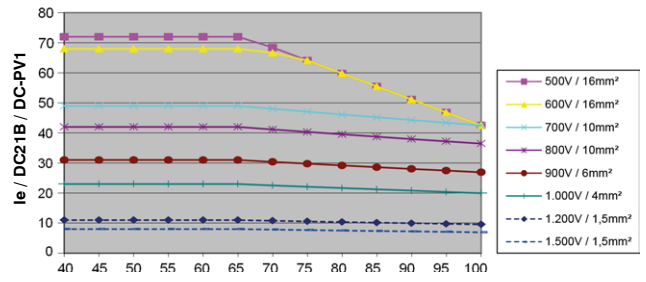

Ambient temperature around the switch (°C)

Switch open LS40..., 4 contacts in series (A4x)

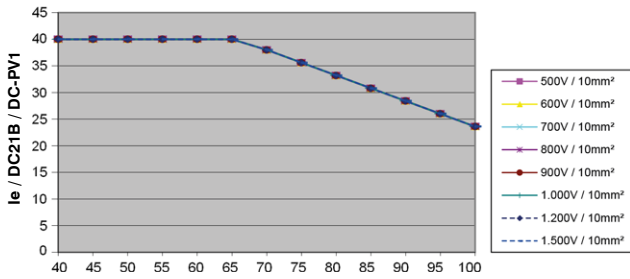

Ambient temperature around the switch (°C)

Switch open LS40..., 4 contacts in series + 2 parallel (A4+2)

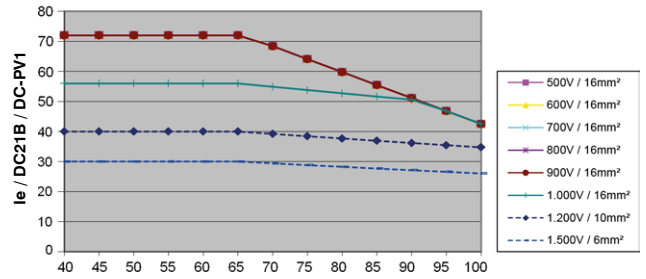

Ambient temperature around the switch (°C)

Switch enclosed LS40..., 2 contacts in series (A2)

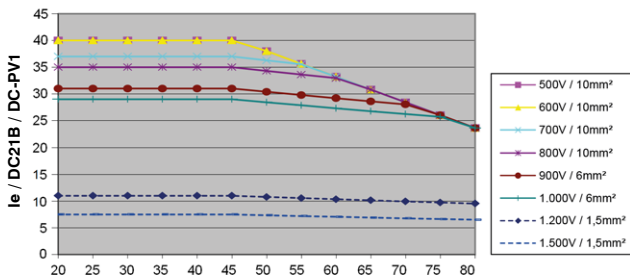

Ambient temperature around the switch (°C)

Switch enclosed LS40..., 2 contacts in series + 2 parallel (A2+2)

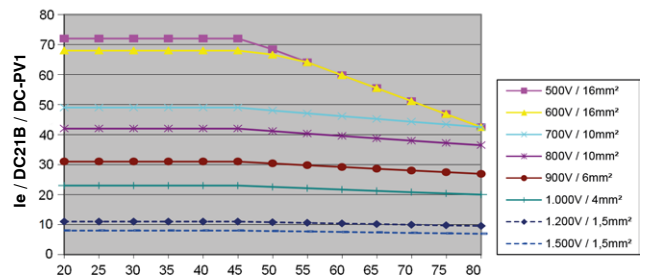

Ambient temperature around the switch (°C)

Switch enclosed LS40PFL..., 4 contacts in series (A4x)

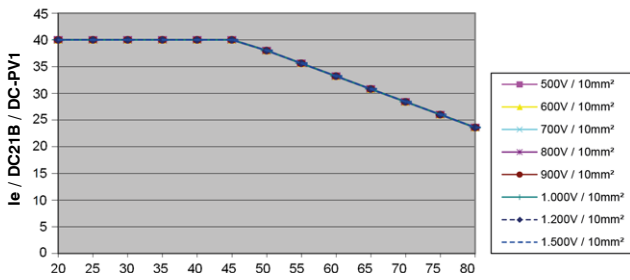

Ambient temperature around the switch (°C)

Switch enclosed LS40PFL..., 4 contacts in series + 2parallel (A4+2)

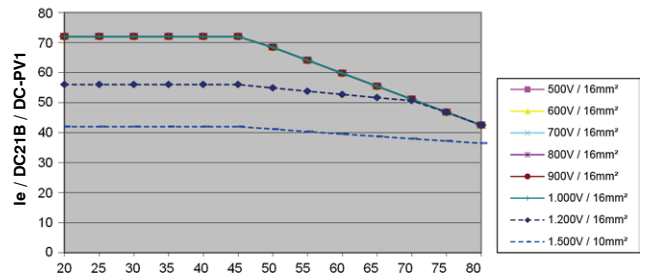

Ambient temperature around the switch (°C)

Technical Datas

Maximum current according to ambient temperature and cable cross section

Switch open LS55..., 2 contacts in series (A2)

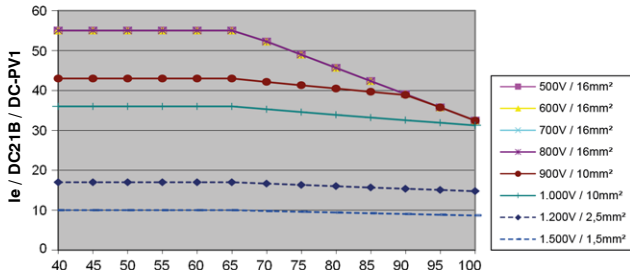

Ambient temperature around the switch (°C)

Switch open LS55..., 2 contacts in series + 2 parallel (A2+2)

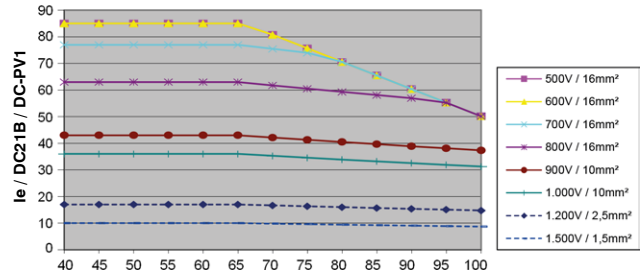

Ambient temperature around the switch (°C)

Switch open LS55..., 4 contacts in series (A4x)

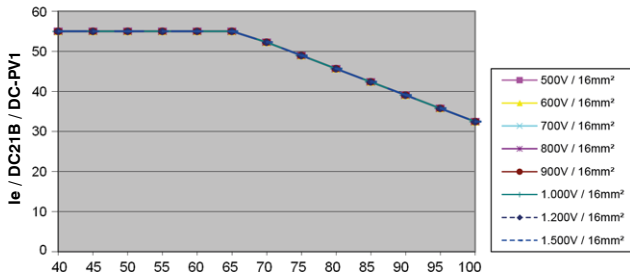

Ambient temperature around the switch (°C)

Switch open LS55..., 4 contacts in series + 2 parallel (A4+2)

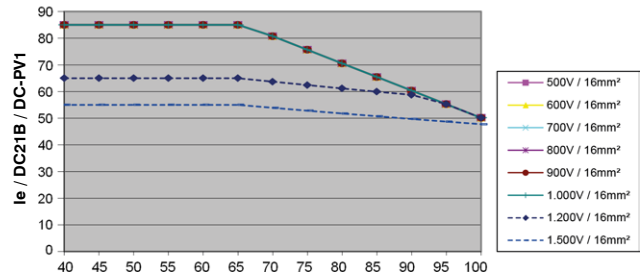

Ambient temperature around the switch (°C)

Switch enclosed LS55..., 2 contacts in series (A2)

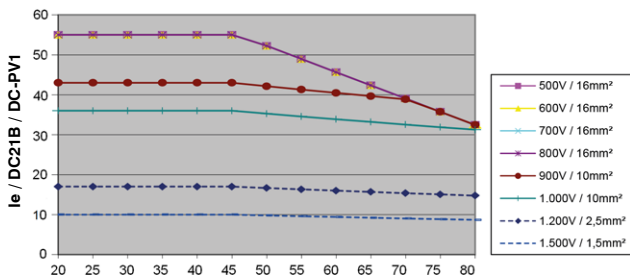

Ambient temperature around the switch (°C)

Switch enclosed LS55..., 2 contacts in series + 2 parallel (A2+2)

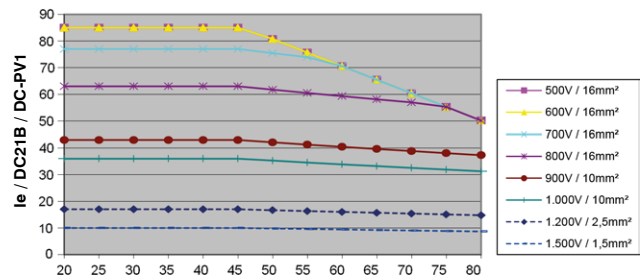

Ambient temperature around the switch (°C)

Switch enclosed LS55PFL..., 4 contacts in series (A4x)

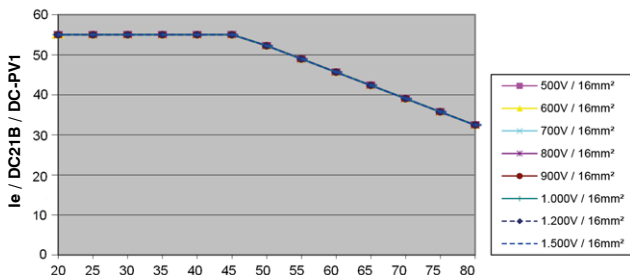

Ambient temperature around the switch (°C)

Switch enclosed LS55PFL..., 4 contacts in series + 2parallel (A4+2)

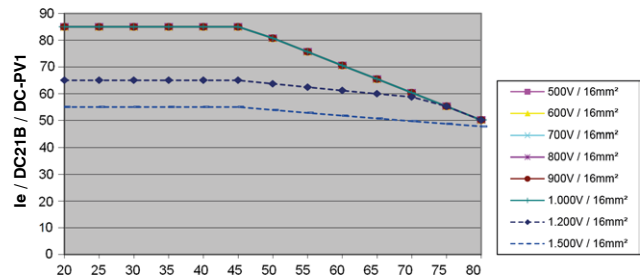

Ambient temperature around the switch (°C)

Dimensions

**LS16 E.., LS25 E.., LS32 E..,
..A2**

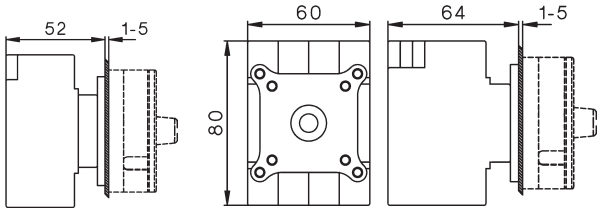

**LS16 E.., LS25 E.., LS32 E..,
..A6, ..A8, ..A3+2, ..A4+2**

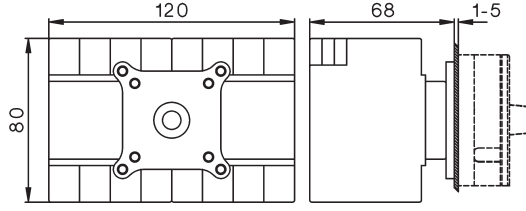

**LS... +VW“x“
Extended Switch Shaft**

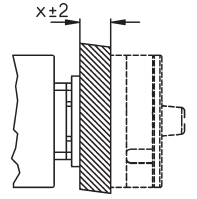

**LS40 E.., LS55 E..
..A2, ..A2+2, ..A4.**

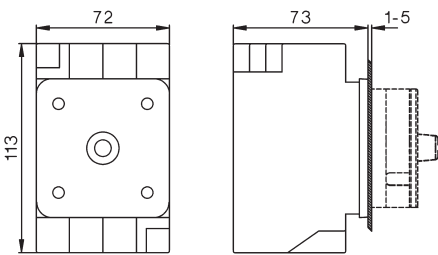

**LS40 E.., LS55 E..
..A6, ..A8, ..A3+2, ..A4+2**

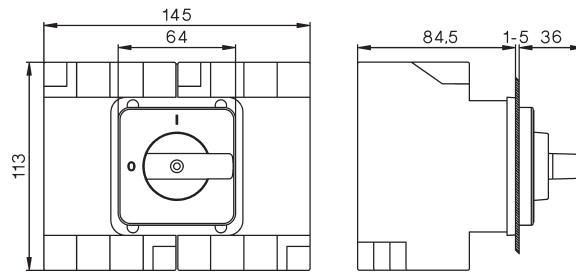

Mounting hole
Mounting screw:
S3631N M=1,2-1,4 Nm

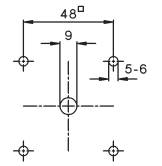

Escutcheon plate 64[□]

Handle

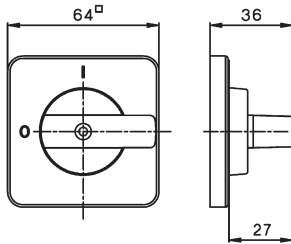

Padlock device SV1.

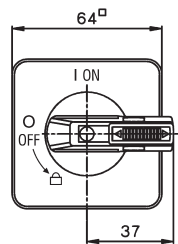

Padlock device SV4.

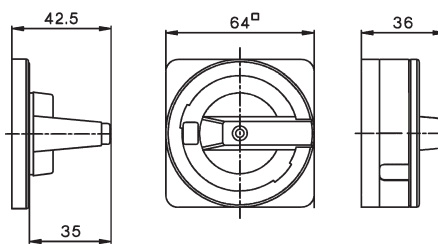

**LS16 Z.., LS25 Z.., LS32 Z..,
..A2**

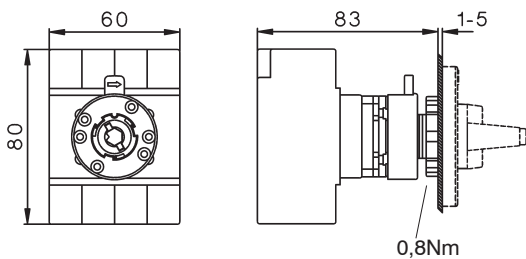

..A2+2, ..A4.

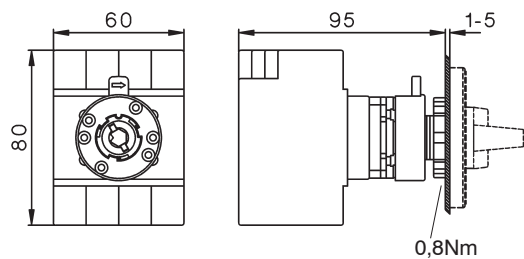

Mounting hole

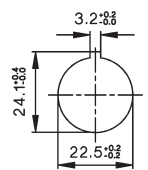

Escutcheon plate 48[□]

Handle

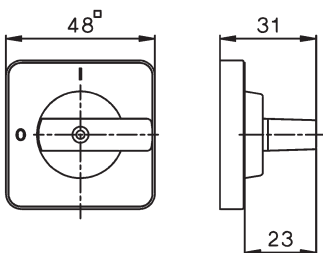

Padlock device SV1.

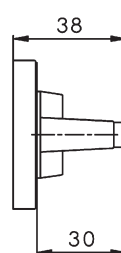
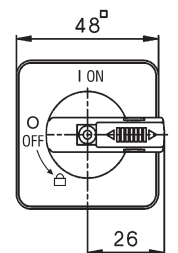

Dimensions

LS16 Z.., LS25 Z.., LS32 Z..,
..A6, ..A8, ..A3+2, ..A4+2

LS.. ZO..

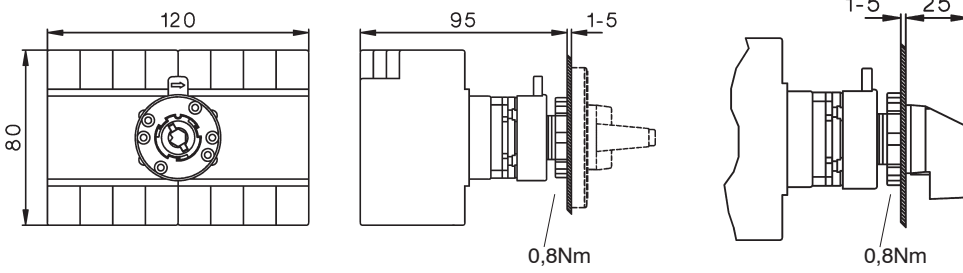

LS16 VZV.., LS25 VZV.., LS32 VZV..,
..A2, ..A2+2, ..A4

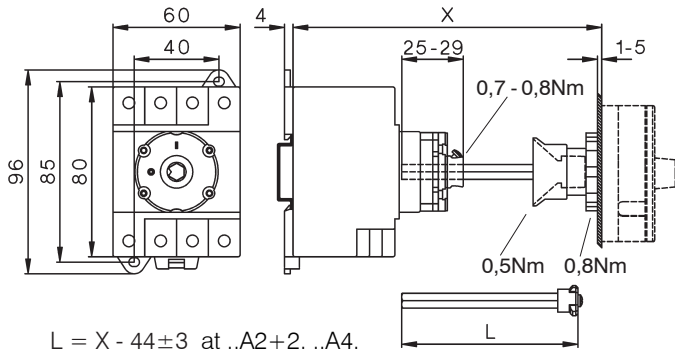

delivered with: ..A2+2, ..A4.
 $X_{max} = 194, L = 150$
 $(X_{min.} = 89)$

delivered with: ..A2
 $X_{max} = 182, L = 150$
 $(X_{min.} = 77)$

Bigger X-Dimensions on request

$L = X - 44 \pm 3$ at ..A2+2, ..A4.
 $L = X - 32 \pm 3$ at ..A2

LS16 VZV.., LS25 VZV.., LS32 VZV..,
..A6, ..A8, ..A3+2, ..A4+2

Mounting hole

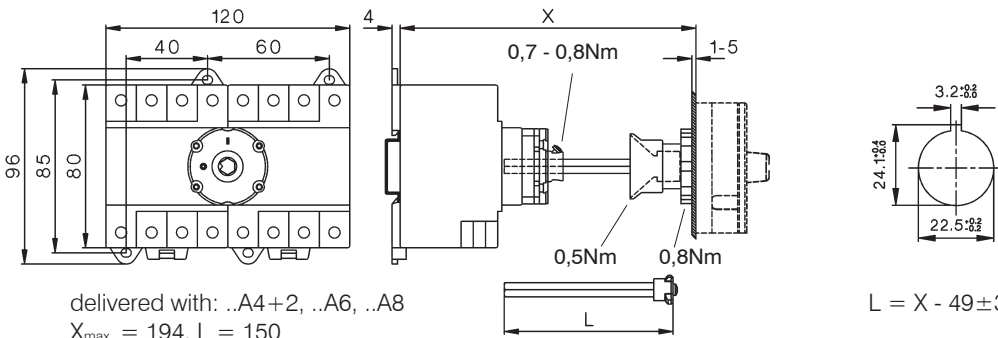

delivered with: ..A4+2, ..A6, ..A8
 $X_{max} = 194, L = 150$
 $(X_{min.} = 95)$

$L = X - 49 \pm 3$

LS40 VZV.., LS55 VZV..
..A2, ..A2+2, ..A4.

LS40 VZV.., LS55 VZV..
..A6, ..A8, ..A3+2, ..A4+2

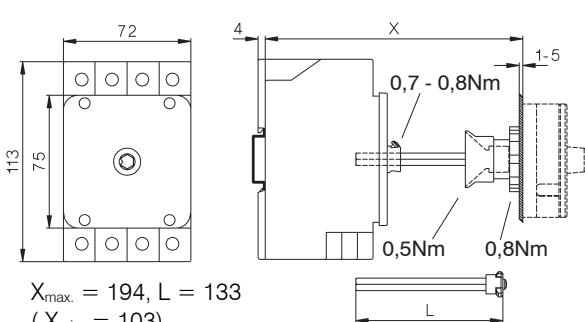

$X_{max} = 194, L = 133$
 $(X_{min.} = 103)$

$L = X - 61 \pm 3$

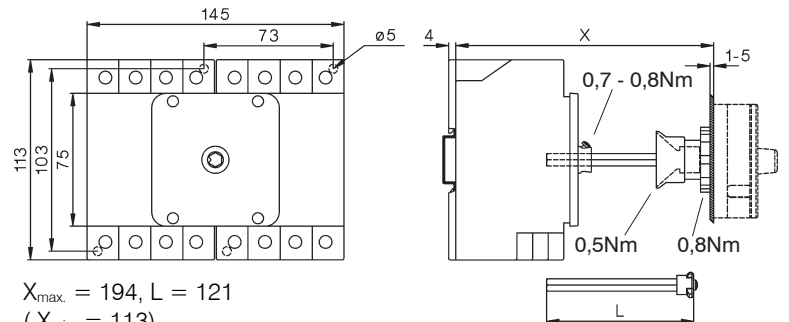

$X_{max} = 194, L = 121$
 $(X_{min.} = 113)$

$L = X - 73 \pm 3$

Dimensions

LS16 SMA..., LS25 SMA..., LS32 SMA..., ..A2

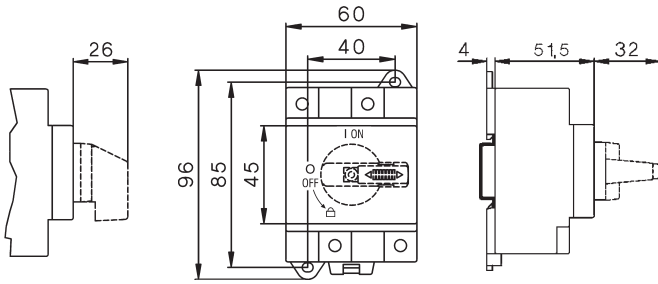

..A2+2, ..A4.

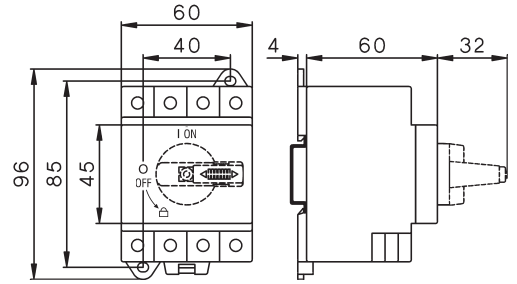

LS40 SMA..., LS55 SMA.. ..A2, ..A2+2, ..A4.

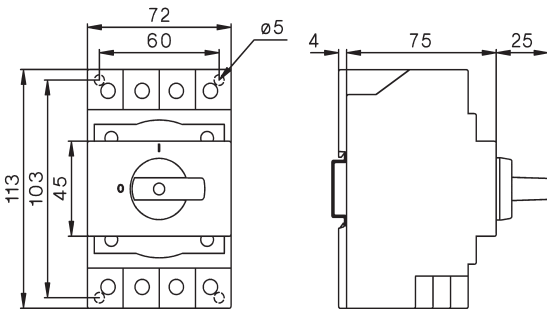

LS40 SMA..., LS55 SMA.. ..A6, ..A8, ..A3+2, ..A4+2

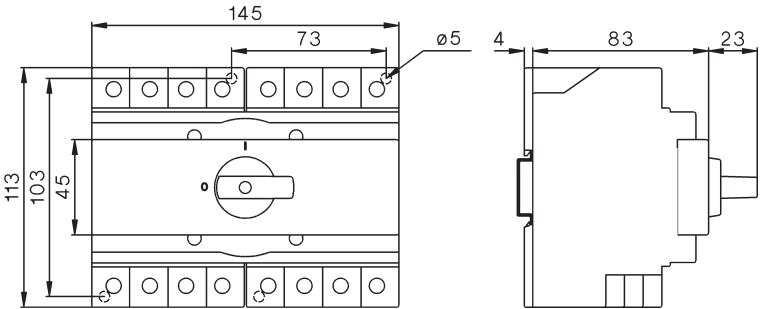

LS16 SMA..., LS25 SMA..., LS32 SMA..., ..A6, ..A8, ..A3+2, ..A4+2

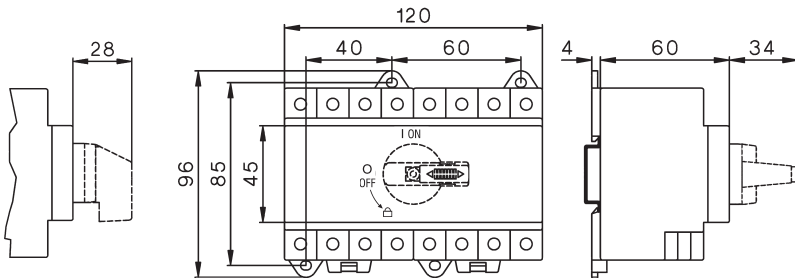

LS.. SMAH1.. with low height handle A2+SV1N

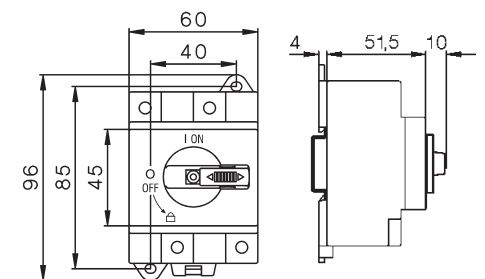

LS16 SMAH1..., LS25 SMAH1, LS32 SMAH1 with low height handle A2+2 +SV1N, A4.+SV1N

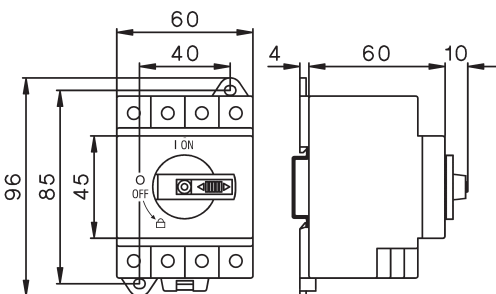

A4+2 +SV1N, A6+SV1N, A8+SV1N

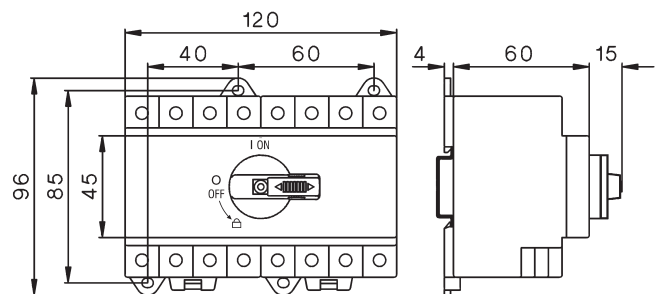

Dimensions:

LS16 PFL..., LS25 PFL..., LS32 PFL..
..A2, ..A2+2, ..A4.

LS16 PFL..., LS25 PFL..., LS32 PFL..
..A2, ..A2+2, ..A4.
+ M25

Main-Switch (lockable)
LS..PFLH4 A..

Main-Switch (lockable)
LS..PFLH4 A..

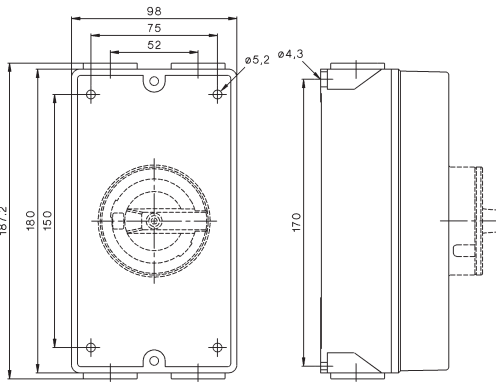
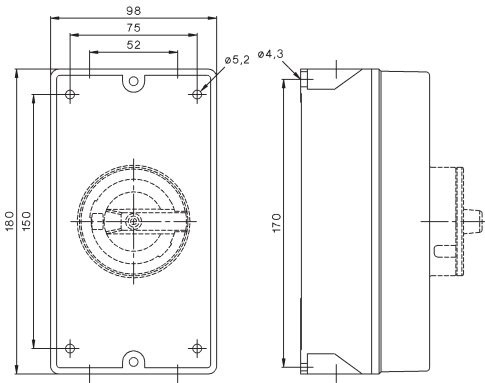
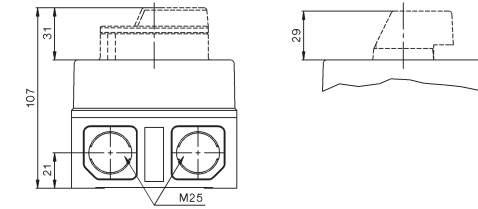
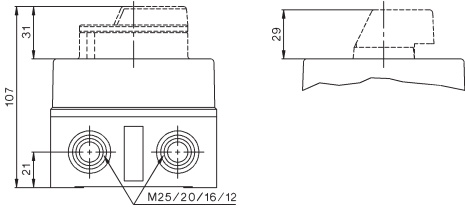

LS16 PFL..., LS25 PFL..., LS32 PFL.. LS40 PFL..., LS55 PFL..
..A6, ..A8, ..A3+2, ..A4+2 ..A2, ..A4, ..A6, ..A8, ..A2+2, ..A3+2, ..A4+2
Main-Switch (lockable)
LS..PFLH4 A..

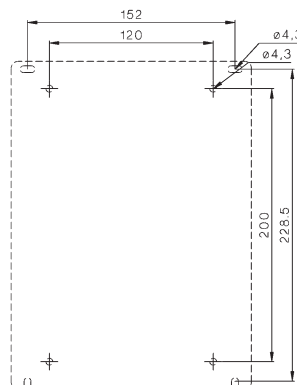
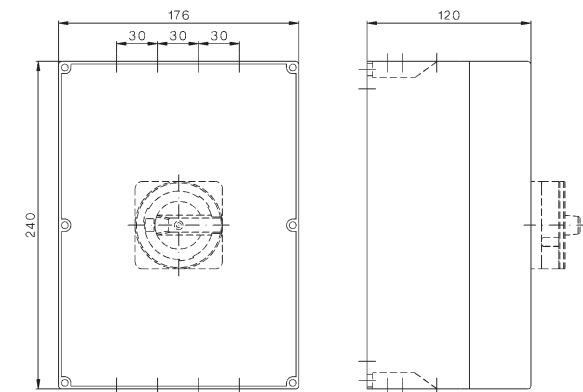
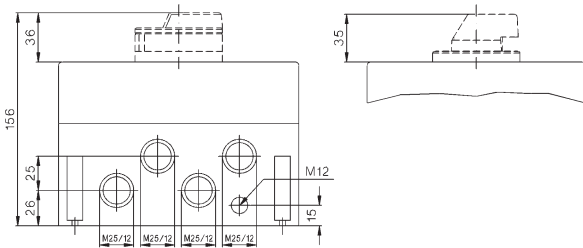



Ø 22,5mm

**Program B3**

Push Buttons

EMERGENCY STOP Buttons

Key Operated Rotary Switches



Rotary Knobs and Swing Knobs

Illuminated Rotary Knobs and Swing Knobs

Illuminated Push Buttons



Double Push Buttons

Lens Caps

Monoblock-Multi-LEDs



Push Button-Sets

Illuminated Push Button-Sets

Pilot Lights



Connectors

Insert Actuator

Contact Blocks and Lamp Holders



Lamps, LED Lamps

Accessories

Label Holder, Legend Plates, Actuator Caps



Ø 30,5mm

**Program B5**

Push Buttons

Rotary Knobs and Swing Knobs



Key Operated Rotary Switches

Illuminated Push Buttons

Lens Caps



Connectors

Contact Blocks and Lamp Holders

Lamps, Accessories

**Units for Surface Mounting**

Assembled Units IP65

**Enclosures BG.**

Contact Blocks and Lamp Holders

for Enclosures BG..

**Push Buttons for Enclosures**

Extensions for Push Buttons

**Technical Data**, Approvals

Dimensions

Actuators and Lens Caps 22mm IP67 (IP65), Type 12

Push Buttons



EMERGENCY STOP Buttons



Illuminated Operators



Double Push Buttons with Indicator Lamp, IP65



Lens Caps

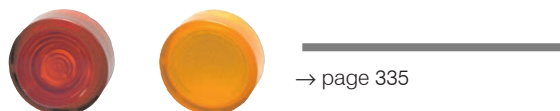

Mono Block Multi Chip LED IP65, IEC 60947, EN 60947

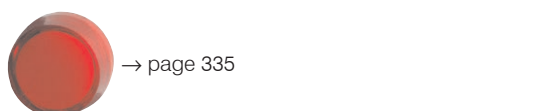

Mounting hole
Ø 22,5mm

with key way

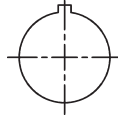

without key way

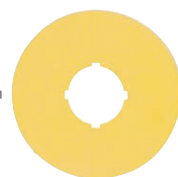
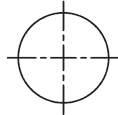

→ page 332



→ page 340

Wrench for Actuators
Lens Caps and
Mono Block Multi Chip LED
J7049



Connectors



Thickness
1 - 6 mm
→ page 340

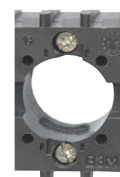

Thickness
1 - 6 mm
→ page 340

Contacts Lamp Holders

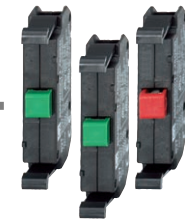

Actuator insert
→ page 338

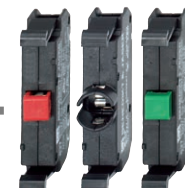

LED
24-230V



Filament
6-130V



Glow-discharge
230V
→ page 339

Actuators 22mm IP67, Type 12

Ring	Colour	Symbol	Alu	Black	Chrome	Pack pcs.	Weight kg/pc.
							
							
							

Push Buttons, Actuator Caps markable see page 337



red			B3D RT	BS3D RT	BC3D RT	10	0,014
red	0		B3D RT-0	BS3D RT-0	BC3D RT-0	10	0,014
green			B3D GN	BS3D GN	BC3D GN	10	0,014
grün	I		B3D GN-I	BS3D GN-I	BC3D GN-I	10	0,014
grün	II		B3D GN-II	BS3D GN-II	BC3D GN-II	10	0,014
grün	→		B3D GN-PF	BS3D GN-PF	BC3D GN-PF	10	0,014
yellow			B3D GE	BS3D GE	BC3D GE	10	0,014
blue			B3D BL	BS3D BL	BC3D BL	10	0,014
white			B3D WS	BS3D WS	BC3D WS	10	0,014
black			B3D SW	BS3D SW	BC3D SW	10	0,014
black	→		B3D SW-PF	BS3D SW-PF	BC3D SW-PF	10	0,014

Push Buttons, Maintained, Actuator Caps markable see page 339



red			B3DR RT	BS3DR RT	BC3DR RT	10	0,014
green			B3DR GN	BS3DR GN	BC3DR GN	10	0,014
yellow			B3DR GE	BS3DR GE	BC3DR GE	10	0,014
blue			B3DR BL	BS3DR BL	BC3DR BL	10	0,014
white			B3DR WS	BS3DR WS	BC3DR WS	10	0,014
black			B3DR SW	BS3DR SW	BC3DR SW	10	0,014

Mushroom Head Ø28mm



red			B3P1 RT	BS3P1 RT	BC3P1 RT	10	0,017
red	0		B3P1 RT-0	BS3P1 RT-0	BC3P1 RT-0	10	0,017
green			B3P1 GN	BS3P1 GN	BC3P1 GN	10	0,017
yellow			B3P1 GE	BS3P1 GE	BC3P1 GE	10	0,017
blue			B3P1 BL	BS3P1 BL	BC3P1 BL	10	0,017
black			B3P1 SW	BS3P1 SW	BC3P1 SW	10	0,017

Mushroom Head Ø40mm



red	0		B3P14 RT-0	BS3P14 RT-0	BC3P14 RT-0	10	0,020
-----	---	--	------------	-------------	-------------	----	-------

Mushroom Head Ø40mm





red			BS3P44T RT	BS3P44T RT	BS3P44T RT	10	0,028
-----	--	--	------------	------------	------------	----	-------

Foot and Palm switch Ø70mm



red			BS3P14P RT	BS3P14P RT	BS3P14P RT	1	0,062
grey			BS3P14P GR	BS3P14P GR	BS3P14P GR	1	0,062

Actuators 22mm IP67, Type 12

Ring	Colour	Symbol/ high	 Alu	 Black	 Chrome	Pack pcs.	Weight kg/pc
------	--------	-----------------	---	---	--	--------------	-----------------

EMERGENCY STOP Push Buttons, according to EN ISO 13850, push to trip, pull to release Ø40mm



red	30mm	BS3P44 RT	BS3P44 RT	BS3P44 RT	10	0,028
red	38mm	BS3P45 RT	BS3P45 RT	BS3P45 RT	10	0,028

EMERGENCY STOP Push Buttons, according to EN ISO 13850, release by key, Ø40mm



red	38mm	BS3P44S3	BS3P44S3	BS3P44S3	1	0,050
Spare Key	lock Ronis R455			B4-R455	1	0,007

EMERGENCY STOP Push Buttons, release by turning, Ø28mm



red		B3P3 RT	BS3P3 RT	BC3P3 RT	10	0,017
red	0	B3P3 RT-0	BS3P3 RT-0	BC3P3 RT-0	10	0,017
red	0	B3P3 RT-0-RGE ²⁾	BS3P3 RT-0-RGE ²⁾	BC3P3 RT-0-RGE ²⁾	10	0,017

EMERGENCY STOP Push Buttons, release by turning, Ø40mm



red	0	B3P34 RT-0	BS3P34 RT-0	BC3P34 RT-0	10	0,020
-----	---	------------	-------------	-------------	----	-------



red	Pfeile	B3P34 RT-PF	BS3P34 RT-PF	BC3P34 RT-PF	10	0,020
-----	--------	-------------	--------------	--------------	----	-------



red illuminated		B3P34L RT	BS3P34L RT	BC3P34L RT	10	0,020
--------------------	--	-----------	------------	------------	----	-------

EMERGENCY STOP Push Buttons, release by turning, Ø70mm



red		BS3P34P RT	BS3P34P RT	BS3P34P RT	1	0,062
-----	--	------------	------------	------------	---	-------

Yellow Disk Ø70mm, Thickness 1mm ¹⁾



neutral		B3-7603	1	0,004
with marking NOT-HALT-symbol		B3-7603-S	1	0,004
with marking NOT-AUS		B3-7603-1	1	0,004
with marking EMERGENCY STOP		B3-7603-2	1	0,004
2-side markings: NOT-AUS / EMERGENCY STOP		B3-7603-12	1	0,004
2-side markings: ARRET D`URGENCE / NØDSTOP		B3-7603-34	1	0,004
2-side markings: ARRET D`URGENCE / NOODSTOP		B3-7603-35	1	0,004

Protection cover against unintentional manipulation, Thickness 1mm



for Push Buttons Ø28mm and Ø40mm	yellow	B3-SK GE	1	0,04
----------------------------------	--------	----------	---	------

Sealing cap

for Buttons BS3P45RT und BS3P44S3	transparent	B3-PH GE	1	0,03
-----------------------------------	-------------	----------	---	------

1) Not for enclosure BG.. 2) Front ring yellow

Actuators 22mm Type 12

Ring	Knob	Alu	Black	Chrome	Pack pcs.	Weight kg/pc.
------	------	-----	-------	--------	-----------	---------------

Rotary Knobs and Swing Knobs, black IP65



Rotary



Swing

maintained 60°	Rotary	B3KN2	BS3KN2	BC3KN2	10	0,020
	Swing	B3KRN2	BS3KRN2	BC3KRN2	10	0,020
maintained 60°	Rotary	B3KN29	BS3KN29	BC3KN29	10	0,020
spring return 60°	Rotary	B3KN8	BS3KN8	BC3KN8	10	0,020
	Swing	B3KRN8	BS3KRN8	BC3KRN8	10	0,020
spring return 60°	Rotary	B3KN1	BS3KN1	BC3KN1	10	0,020
	Swing	B3KRN1	BS3KRN1	BC3KRN1	10	0,020
maintained 60°	Rotary	B3KN3	BS3KN3	BC3KN3	10	0,020
	Swing	B3KRN3	BS3KRN3	BC3KRN3	10	0,020
maintained/spring return 60°	Rotary	B3KN6	BS3KN6	BC3KN6	10	0,020
spring return/maintained 60°	Rotary	B3KN7	BS3KN7	BC3KN7	10	0,020
maintained 120°	Rotary	B3KN9	BS3KN9	BC3KN9	10	0,020
maintained 90° according to EN81	Rotary	B3KN10	BS3KN10	BC3KN10	10	0,020
maintained 90°	Rotary	B3KN11	BS3KN11	BC3KN11	10	0,020

Illuminated Rotary Knobs and Swing Knobs, clear IP67, lamp max. 1,2W, lamps see page 339



Rotary



Swing

maintained 90°	Rotary	B3KL2	BS3KL2	BC3KL2	10	0,016
spring return 60°	Rotary	B3KL1	BS3KL1	BC3KL1	10	0,016
	Swing	B3KRL1	BS3KRL1	BC3KRL1	10	0,016
maintained 60°	Rotary	B3KL3	BS3KL3	BC3KL3	10	0,016
	Swing	B3KRL3	BS3KRL3	BC3KRL3	10	0,016
maintained/spring return 60°	Rotary	B3KL6	BS3KL6	BC3KL6	10	0,016
O - I		B3E	BS3E	BC3E	10	0,017

Toggle IP65



Actuators 22mm IP65, Type 12

Ring	Key removeable in	Alu	Black	Chrome	Pack pcs.	Weight kg/pc.
						
						
						

Key Operated Rotary Switches with lock Ronis 455



B3SAR 0

maintained 60°



B3SAR 0	BS3SAR 0	BC3SAR 0	1	0,044
B3SAR 1	BS3SAR 1	BC3SAR 1	1	0,044
B3SAR 01	BS3SAR 01	BC3SAR 01	1	0,044



B3SARR 0

spring return 60°



B3SAT 0	BS3SAT 0	BC3SAT 0	1	0,044
---------	----------	----------	---	-------

maintained 60°



B3SARR 0	BS3SARR 0	BC3SARR 0	1	0,044
B3SARR 102	BS3SARR 102	BC3SARR 102	1	0,044

spring return/maintained 60°



B3SATR 02	BS3SATR 02	BC3SATR 02	1	0,044
-----------	------------	------------	---	-------

spring return 60°



B3SATT 0	BS3SATT 0	BC3SATT 0	1	0,044
----------	-----------	-----------	---	-------

Spare Key lock Ronis R455

B4-R455	1	0,007
---------	---	-------

Colour Symbol

Pack
pcs. Weight
kg/pc.

Illuminated Push Buttons IP67, lamp max. 1,9W, lamps see page 339



red	B3DL RT	BS3DL RT	BC3DL RT	10	0,014
green	B3DL GN	BS3DL GN	BC3DL GN	10	0,014
yellow	B3DL GE	BS3DL GE	BC3DL GE	10	0,014
blue	B3DL BL	BS3DL BL	BC3DL BL	10	0,014
white	B3DL WS	BS3DL WS	BC3DL WS	10	0,014

Illuminated Push Buttons, Maintained IP67, lamp max. 1,9W, lamps see page 339



red	B3DLR RT	BS3DLR RT	BC3DLR RT	10	0,014
green	B3DLR GN	BS3DLR GN	BC3DLR GN	10	0,014
yellow	B3DLR GE	BS3DLR GE	BC3DLR GE	10	0,014
blue	B3DLR BL	BS3DLR BL	BC3DLR BL	10	0,014
white	B3DLR WS	BS3DLR WS	BC3DLR WS	10	0,014

Double Push Buttons, with indicator lamp white, lamp max. 1,9W, lamps see page 339



green red	B3DT G/R ¹⁾	BS3DT G/R	BC3DT G/R	10	0,016
white black	B3DT W/S ¹⁾	BS3DT W/S	BC3DT W/S	10	0,016
green red	I 0	B3DT GI/RO ¹⁾	BS3DT GI/RO	10	0,016
white black	I 0	B3DT WI/SO ¹⁾	BS3DT WI/SO	10	0,016

with non-standard marking on request

1) Plastic ring in alu design

Lens Caps 22mm Type 12

suitable for Alu, Black and Chrome

Colour

Type

Pack pcs.

Weight kg/pc.

Lens Caps IP67 with fresnel lens, lamp max. 1,9W, lamps see page 339, laser marking on request



red	B3R RT	10	0,009
green	B3R GN	10	0,009
yellow	B3R GE	10	0,009
blue	B3R BL	10	0,009
clear	B3R KL	10	0,009
white	B3R WS	10	0,009

Lens Caps Low IP67 with fresnel lens, lamp max. 1,9W, lamps see page 339, laser marking on request



red	B3RN RT	10	0,008
green	B3RN GN	10	0,008
yellow	B3RN GE	10	0,008
blue	B3RN BL	10	0,008
clear	B3RN KL	10	0,008
white	B3RN WS	10	0,008

Lens Caps IP67, lamp max. 1,9W, lamps see page 337, laser marking on request

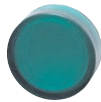

red	B3RF RT	10	0,009
green	B3RF GN	10	0,009
yellow	B3RF GE	10	0,009
blue	B3RF BL	10	0,009
white	B3RF WS	10	0,009

Colour

Voltage

Power VA

W

Type

Pack pcs.

Weight kg/pc

Monoblock LEDs IP65, IEC 60947, EN 60947 (6 years middle lifetime)



red	20-30V AC/DC	0,4	0,4	B3-MB24 RTB	10	0,022
green	20-30V AC/DC	0,4	0,4	B3-MB24 GNB	10	0,022
yellow	20-30V AC/DC	0,4	0,4	B3-MB24 GEB	10	0,022
blue	20-30V AC/DC	0,4	0,4	B3-MB24 BLB	10	0,022
white	20-30V AC/DC	0,4	0,4	B3-MB24 WSB	10	0,022
red	110-130V AC 110V DC	1,2	1,2	B3-MB110 RTB	10	0,022
green	110-130V AC 110V DC	1,2	1,2	B3-MB110 GNB	10	0,022
yellow	110-130V AC 110V DC	1,2	1,2	B3-MB110 GEB	10	0,022
blue	110-130V AC 110V DC	1,2	1,2	B3-MB110 BLB	10	0,022
white	110-130V AC 110V DC	1,2	1,2	B3-MB110 WSB	10	0,022
red	170-250V AC	4,0	1,0	B3-MB230 RTB	10	0,022
green	170-250V AC	4,0	1,0	B3-MB230 GNB	10	0,022
yellow	170-250V AC	4,0	1,0	B3-MB230 GEB	10	0,022
blue	170-250V AC	4,0	1,0	B3-MB230 BLB	10	0,022
white	170-250V AC	4,0	1,0	B3-MB230 WSB	10	0,022
red	400V AC		0,5	B3-MB400 RTB	10	0,022
green	400V AC		0,5	B3-MB400 GNB	10	0,022
yellow	400V AC		0,5	B3-MB400 GEB	10	0,022
blue	400V AC		0,5	B3-MB400 BLB	10	0,022
white	400V AC		0,5	B3-MB400 WSB	10	0,022

Push Button 22mm-Sets, with Contact Block and Connector

Actuator Colour	Symbol	with	Type	Pack pcs.	Weight kg/pc.
-----------------	--------	------	------	-----------	---------------

Push Buttons, IP67

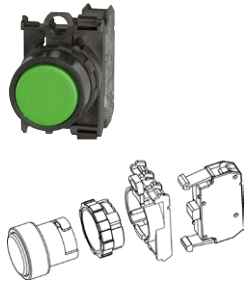

black		+connector +1NO	BS3D SW/10	1	0,037
green		+connector +1NO	BS3D GN/10	1	
yellow		+connector +1NO	BS3D GE/10	1	0,037
blue		+connector +1NO	BS3D BL/10	1	0,037
red		+connector +1NC	BS3D RT/01	1	
green		+connector +1NO	BS3D GN-I/10	1	0,037
red		+connector +1NC	BS3D RT-0/01	1	0,037

Double Push Buttons, IP65



green/ red		+connector +1NO +1NC	BS3DT G/R/11	1	0,049
------------	--	----------------------	--------------	---	-------

EMERGENCY STOP Push Buttons, IP67 Ø40mm



pull to release acc. EN ISO 13850		+connector +1NO +1NC	BS3P44 RT/11	1	0,061
key release acc. EN ISO 13850		+connector +1NO +1NC	BS3P44S3 RT/11	1	0,083
twist release		+connector +1NO +1NC	BS3P34 RT-0/11	1	0,053

Rotary Knobs, IP65



		+connector +1NO	BS3KN2/10	1	0,043
		+connector +1NO +1NC	BS3KN2/11	1	0,053
		+connector +2NO	BS3KN3/20	1	0,053
		+connector +2NO	BS3KN1/20	1	0,053

Key Operated Rotary Switch with lock Ronis 455, IP65



	key removeable in 0-position	+connector +1NO	BS3SAR 0/10	1	0,057
	key removeable in all positions	+connector +1NO	BS3SAR 01/10	1	0,057
	key removeable in 0-position	+connector +1NO	BS3SAT 0/10	1	0,057



	key removeable in all positions	+connector +2NO	BS3SARR 102/20	1	0,067
	key removeable in 0-position	+connector +2NO	BS3SARR 0/20	1	0,067

Illuminated Push Button 22mm-Sets, with Contact Block, Connector and LED

Actuator Colour with LED Type Pack pcs. Weight kg/pc.

Illuminated Push Buttons, IP67

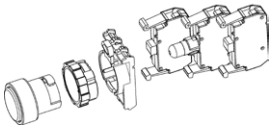

white	+connector +1NO +1NC +LED	20-30V AC/DC	BS3DL WS/11/L24	1	0,054
green	+connector +1NO +1NC +LED	20-30V AC/DC	BS3DL GN/11/L24	1	0,054
red	+connector +1NO +1NC +LED	20-30V AC/DC	BS3DL RT/11/L24	1	0,054
yellow	+connector +1NO +1NC +LED	20-30V AC/DC	BS3DL GE/11/L24	1	0,054
blue	+connector +1NO +1NC +LED	20-30V AC/DC	BS3DL BL/11/L24	1	0,054
white	+connector +1NO +1NC +LED	90-120V AC/DC	BS3DL WS/11/L110	1	0,054
green	+connector +1NO +1NC +LED	90-120V AC/DC	BS3DL GN/11/L110	1	0,054
red	+connector +1NO +1NC +LED	90-120V AC/DC	BS3DL RT/11/L110	1	0,054
yellow	+connector +1NO +1NC +LED	90-120V AC/DC	BS3DL GE/11/L110	1	0,054
blue	+connector +1NO +1NC +LED	90-120V AC/DC	BS3DL BL/11/L110	1	0,054
white	+connector +1NO +1NC +LED	200-250V AC/DC	BS3DL WS/11/L230	1	0,054
green	+connector +1NO +1NC +LED	200-250V AC/DC	BS3DL GN/11/L230	1	0,054
red	+connector +1NO +1NC +LED	200-250V AC/DC	BS3DL RT/11/L230	1	0,054
yellow	+connector +1NO +1NC +LED	200-250V AC/DC	BS3DL GE/11/L230	1	0,054
blue	+connector +1NO +1NC +LED	200-250V AC/DC	BS3DL BL/11/L230	1	0,054

Double Push Buttons with Pilot Light, IP65



green/ red	+connector +1NO +1NC +LED	20-30V AC/DC	BS3DT G/R/11/L24	1	0,066
green/ red	+connector +1NO +1NC +LED	90-120V AC/DC	BS3DT G/R/11/L110	1	0,066
green/ red	+connector +1NO +1NC +LED	200-250V AC/DC	BS3DT G/R/11/L230	1	0,066

Pilot Lights, IP67 with socket BA9S (without lamp)



white	+connector +socket BA9S	-	B3R WS/0	1	0,037
green	+connector +socket BA9S	-	B3R GN/0	1	0,037
red	+connector +socket BA9S	-	B3R RT/0	1	0,037
yellow	+connector +socket BA9S	-	B3R GE/0	1	0,037

Pilot Lights with LEDs, IP67



white	+connector +socket BA9S	20-30V AC/DC	B3R WS/L24	1	0,042
green	+connector +socket BA9S	20-30V AC/DC	B3R GN/L24	1	0,042
red	+connector +socket BA9S	20-30V AC/DC	B3R RT/L24	1	0,042
yellow	+connector +socket BA9S	20-30V AC/DC	B3R GE/L24	1	0,042
white	+connector +socket BA9S	90-120V AC/DC	B3R WS/L110	1	0,042
green	+connector +socket BA9S	90-120V AC/DC	B3R GN/L110	1	0,042
red	+connector +socket BA9S	90-120V AC/DC	B3R RT/L110	1	0,042
yellow	+connector +socket BA9S	90-120V AC/DC	B3R GE/L110	1	0,042
white	+connector +socket BA9S	200-250V AC/DC	B3R WS/L230	1	0,042
green	+connector +socket BA9S	200-250V AC/DC	B3R GN/L230	1	0,042
red	+connector +socket BA9S	200-250V AC/DC	B3R RT/L230	1	0,042
yellow	+connector +socket BA9S	200-250V AC/DC	B3R GE/L230	1	0,042

Connectors

Specification	Description	Type	Pack pcs.	Weight kg/pc.
Connector B3S		B3S	10	0,013

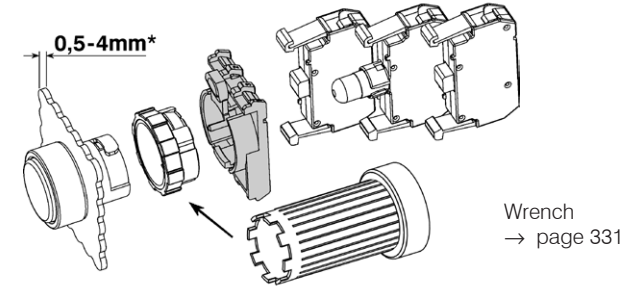

Connector B3M		B3M	10	0,013
---------------	--	-----	----	-------

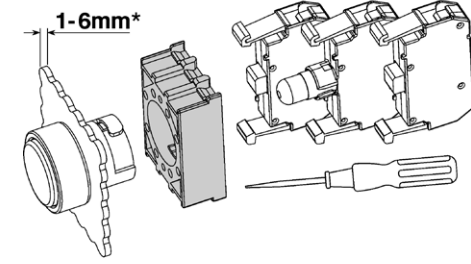

*) inclusive Thickness from Label Holder and Yellow Disk

Contact Blocks and Lamp Holders for Panel Mounting

for voltage	Description	Type	Pack pcs.	Weight kg/pc.
Contact blocks, screw terminals				
max. 690V AC	1 NC ¹⁾	B3T01 ²⁾	10	0,010
max. 690V AC	1 NO ¹⁾	B3T10 ²⁾	10	0,010
Contact blocks, RAST 5 terminals (note coding)				
max. 690V~	1 NC	B3RT01	10	0,010
max. 690V~	1 NO	B3RT10	10	0,010
Actuator insert	to actuate the center contact block	P642	10	0,001

Lamp holders, socket BA9s

max. 440V AC/DC	direct connection, for lamps max. 1,9W (active power consumption)	X1 X2	B3F	10	0,012
-----------------	---	-------	-----	----	-------

Lamp holders for lamp test circuits, socket BA9s

max. 440V AC	direct connection, for filament and glow-discharge lamps max. 1,7W (active power consumption)	X5 X2 X1	B3FT	10	0,020
max. 250V	direct connection of LED	X5 X2 X1	B3FTD	10	0,020

1) NC contact has a positive opening according to IEC/EN 60947-5-1
 2) Contact blocks with gold contacts (B3T..G) on request suitable for 17V= /1mA and for difficult ambient conditions.

Lamps

Socket BA9s
Lamp voltage

Type

Pack
pcs.

Weight
kg/pc.

LED lamps²⁾ (6 years middle lifetime, for equivalent lens caps only)



24V 10mA AC/DC +-10%	for red lens caps	B3-L24 RTB	50	0,005
24V 10mA AC/DC +-10%	for green lens caps	B3-L24 GNB	50	0,005
24V 10mA AC/DC +-10%	for yellow lens caps	B3-L24 GEB	50	0,005
24V 10mA AC/DC +-10%	for blue lens caps	B3-L24 BLB	50	0,005
24V 10mA AC/DC +-10%	for white lens caps	B3-L24 WSB	50	0,005
110V 3,2mA AC/DC +-10%	for red lens caps	B3-L110 RTB	50	0,005
110V 3,2mA AC/DC +-10%	for green lens caps	B3-L110 GNB	50	0,005
110V 3,2mA AC/DC +-10%	for yellow lens caps	B3-L110 GEB	50	0,005
110V 3,2mA AC/DC +-10%	for blue lens caps	B3-L110 BLB	50	0,005
110V 3,2mA AC/DC +-10%	for white lens caps	B3-L110 WSB	50	0,005
220V 1,7mA AC/DC +-10%	for red lens caps	B3-L230 RTB	50	0,005
220V 1,7mA AC/DC +-10%	for green lens caps	B3-L230 GNB	50	0,005
220V 1,7mA AC/DC +-10%	for yellow lens caps	B3-L230 GEB	50	0,005
220V 1,7mA AC/DC +-10%	for blue lens caps	B3-L230 BLB	50	0,005
220V 1,7mA AC/DC +-10%	for white lens caps	B3-L230 WSB	50	0,005

Filament lamps



	Power consumption				
24V	1,2W	for all lens caps	B4-G24	100	0,005
42V	1W	for all lens caps	B4-G42	100	0,005
48V	1,2W	for all lens caps	B4-G48	100	0,005
60V	1,2W	for all lens caps	B4-G60	100	0,005
110/120V 1)	1,5/1,8W	for all lens caps	B4-G130	100	0,005

Glow-discharge lamps



220-250V AC	0,3W	for clear, red, yellow lens caps	B4-GL230K	100	0,005
220-250V AC	0,3W	for green, blue lens caps	B4-GL230G	100	0,005

Accessories



		Type	Pack pcs.	Weight kg/pc.	
Wrench	for mounting of actuators and lens caps B(S)3..	J7049	1	0,018	
Marking plate	for marking of contact blocks B3T. and lamp holders B3F	P672-1	10	0,001	
Lamp Installer	used to install or replace lamps BA9s	B4-7408	1	0,010	
Spare Key	for B(S)3SA.. and BS3P44S3, Ronis R455 for B(S)3SB.., Ronis R786	B4-R455 B4-R786	1 1	0,007 0,007	
Hole Plug	black, for fixing holes grey Ø22,5mm	B3-DU SW B3-DU GR	10 10	0,007 0,007	
Sealing Cover	for single and double push buttons, protection except B3D..R..(maintained) against coarse petrol-resistant, ambient temp. 0°...+50°C contamination	P279-1	1	0,003	
	for all single push buttons silicone, ambient temp. -25°...+60 °C	P279-5	1	0,003	
	for double push buttons silicone, ambient temp. -25°...+60 °C	P279-DT	1	0,003	
Protection cover	against unintentional manipulation				
	Thickness 1mm yellow	B3-SK GE	1	0,04	
	Thickness 1mm grey	B3-SK GR	1	0,04	
Protection ring with thread	against unintentional manipulation has to be mounted instead of the existing ring	black chrome alu	P921-1 P921-2 P921-3	1 1 1	0,012 0,012 0,012

1) Voltage marking 130V / 2W max. rated voltage 120V / 1,8W

2) suitable for B3FT lamp test lamp holders

Label Holders and Legend Plates for Push Buttons B3, 22mm

Marking 1 or 2 lines



	Type	Pack pcs.	Weight kg/pc.
Label holder for legend plate BK4, black, Thickness 0,8mm	P751	100	0,001
Label holder for legend plate BK4, yellow, Thickness 0,8mm	P751-3	10	0,001

marking	Type	marking	Type	Pack pcs.	Weight kg/pc.
---------	------	---------	------	-----------	---------------

Legend plate alu, for label holder P751



blank	BK4-9736			100	0,0002
I	BK4-I	II	BK4-II	10	0,0002
III	BK4-III	IV	BK4-IV	10	0,0002
V	BK4-V			10	0,0002

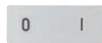

→	BK4--->	←	BK4-<--	10	0,0002
0 I	BK4-0-I	H 0 A	BK4-H 0 A	10	0,0002
0 I	BK4-0__I	1 0 2	BK4-1 0 2	10	0,0002



START	BK4-START	STOP	BK4-STOP	10	0,0002
EIN	BK4-EIN	AUS	BK4-AUS	10	0,0002
BETRIEB	BK4-BETRIEB	STÖRUNG	BK4-STÖRUNG	10	0,0002



VOR	BK4-VOR	ZURÜCK	BK4-ZURÜCK	10	0,0002
HEBEN	BK4-HEBEN	SENKEN	BK4-SENKEN	10	0,0002
LINKS	BK4-LINKS	RECHTS	BK4-RECHTS	10	0,0002

MEHR	BK4-MEHR	WENIGER	BK4-WENIGER	10	0,0002
SCHNELL	BK4-SCHNELL	LANGSAM	BK4-LANGSAM	10	0,0002
HELLER	BK4-HELLER	DUNKLER	BK4-DUNKLER	10	0,0002

AUF	BK4-AUF	ZU	BK4-ZU	10	0,0002
AB	BK4-AB	HALT	BK4-HALT	10	0,0002
EILGANG	BK4-EILGANG	TIPPEN	BK4-TIPPEN	10	0,0002

Legend plate with non-standard marking (e. g.: BK4-MOTOR-START)

Text 1 line, max. 11 letters, letter height 3mm	BK4-...	1	0,0002
Text 2 lines, max. 2 x 11 letters, letter height 3mm	BK4-...-...	1	0,0002

Legend plate yellow, for label holder P751-3



Legend plate yellow without marking	BK4-10827	10	0,0002
Legend plate yellow with marking NOT-AUS	BK4-10827-1	10	0,0002
Legend plate yellow with marking EMERGENCY STOP	BK4-10827-2	10	0,0002
Legend plate yellow with marking ARRET D`URGENCE	BK4-10827-3	10	0,0002

Marking 3 or 4 lines



Label holder for legend plate BK8, black, Thickness 0,8mm	P761	10	0,0013
Label holder for legend plate BK8, yellow, Thickness 0,8mm	P761-3	10	0,0013
Label holder for BK8, for double push buttons only	P761-DT	10	0,0013

Legend plate BK8 for label holder P761 (with marking e. g.: BK8-WATER-PUMP-START)



Legend plate without marking	BK8-9736	10	0,0004
Text 3 lines, max. 3 x 11 letters, letter height 3mm	BK8-...-...-...	10	0,0004
Text 4 lines, max. 4 x 11 letters, letter height 3mm	BK8-...-...-...-...	10	0,0004

Actuator Caps with Laser Marking

Code for colours

Colour	for buttons		for illuminated buttons	
	B3D(R)	B5D(R)	B3DL(R)	B5DL(R)
red	B3D(R)	B5D(R)	B3DL(R)	B5DL(R)
green	BS3D(R)	BS5D(R)	BS3DL(R)	BS5DL(R)
yellow	BC3D(R)	BC5D(R)	BC3DL(R)	BC5DL(R)
blue	DK RT..	DKL RT..	DKL GN..	
white	DK GN..	DKL GE..	DKL BL..	
black	DK GE..	DKL WS..		
	DK BL..			
	DK WS..			
	DK SW..	-		

marking	Type	-suffix for marking	marking	Type	-suffix for marking.	Pack pcs.	Weight kg/pc
---------	------	---------------------	---------	------	----------------------	-----------	--------------

Actuator Caps with text, the Type must be completed with the code for colours



			NOT AUS	...-NOT-AUS	10	0,001
START	...-START		STOP	...-STOP	10	0,001
EIN	...-EIN		AUS	...-AUS	10	0,001
BETRIEB	...-BETRIEB		STÖRUNG	...-STÖRUNG	10	0,001
ANLAUF	...-ANLAUF		HALT	...-HALT	10	0,001
VOR	...-VOR		ZURÜCK	...-ZURÜCK	10	0,001
HEBEN	...-HEBEN		SENKEN	...-SENKEN	10	0,001
LINKS	...-LINKS		RECHTS	...-RECHTS	10	0,001
MEHR	...-MEHR		WENIGER	...-WENIGER	10	0,001
SCHNELL	...-SCHNELL		LANGSAM	...-LANGSAM	10	0,001
HELLER	...-HELLER		DUNKLER	...-DUNKLER	10	0,001
AUF	...-AUF		ZU	...-ZU	10	0,001
AB	...-AB		LAUF	...-LAUF	10	0,001
EILGANG	...-EILGANG		TIPPEN	...-TIPPEN	10	0,001

Actuator Caps with symbols according to DIN 30600, the Type must be completed with the code for colours

	...-100		...-101	10	0,001
	...-102		...-103	10	0,001
	...-200		...-201	10	0,001
	...-202		...-203	10	0,001
	...-204		...-205	10	0,001
	...-300		...-301	10	0,001
	...-302		...-303	10	0,001
	...-304		...-305	10	0,001
	...-306		...-307	10	0,001
	...-400		...-401	10	0,001
	...-402		...-403	10	0,001
	...-404		...-405	10	0,001
	...-406		...-407	10	0,001
	...-408		...-409	10	0,001
	...-410		...-411	10	0,001
	...-412		...-413	10	0,001

Actuators and Lens Caps 30mm IP67 (IP65)

Push Buttons



→ page 343



IP65
→ page 344,
345

EMERGENCY STOP Buttons

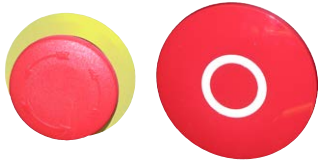

→ page 343

Illuminated Operators



→ page 345

Lens Caps



→ page 345

Mounting hole
Ø 30,5mm

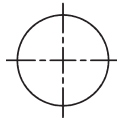

→ page 343



→ page 347

Connectors



Thickness
0,5 - 3 mm
→ page 346

Contacts Lamp Holder

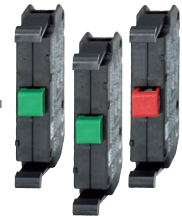

Actuator insert
→ page 346

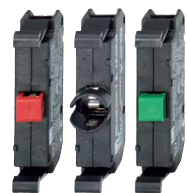

→ page 346



LED
24-230V



Filament
6-130V



Glow-discharge
230V

→ page 347

Wrench
J7049



Actuators 30mm IP67

Ring	Colour	Symbol	Alu	Black	Chrome	Pack pcs.	Weight kg/pc.
------	--------	--------	-----	-------	--------	-----------	---------------

Push Buttons, Actuator Caps markable



red			B5D RT	BS5D RT	BC5D RT	10	0,029
red	0		B5D RT-0	BS5D RT-0	BC5D RT-0	10	0,029
green			B5D GN	BS5D GN	BC5D GN	10	0,029
green	I		B5D GN-I	BS5D GN-I	BC5D GN-I	10	0,029
green	II		B5D GN-II	BS5D GN-II	BC 5D GN-II	10	0,029
green	→		B5D GN-PF	BS5D GN-PF	BC5D GN-PF	10	0,029



yellow			B5D GE	BS5D GE	BC5D GE	10	0,029
blue			B5D BL	BS5D BL	BC5D BL	10	0,029
white			B5D WS	BS5D WS	BC 5D WS	10	0,029
black			B5D SW	BS5D SW	BC5D SW	10	0,029
black	→		B5D SW-PF	BS5D SW-PF	BC5D SW-PF	10	0,029

Push Buttons, Maintained, Actuator Caps markable



red			B5DR RT	BS5DR RT	BC5DR RT	10	0,029
green			B5DR GN	BS5DR GN	BC5DR GN	10	0,029
yellow			B5DR GE	BS5DR GE	BC5DR GE	10	0,029
blue			B5DR BL	BS5DR BL	BC5DR BL	10	0,029
white			B5DR WS	BS5DR WS	BC5DR WS	10	0,029
black			B5DR SW	BS5DR SW	BC5DR SW	10	0,029

Mushroom Heads, Ø28mm



red			B5P1 RT	BS5P1 RT	BC5P1 RT	10	0,032
red	0		B5P1 RT-0	BS5P1 RT-0	BC5P1 RT-0	10	0,032
green			B5P1 GN	BS5P1 GN	BC5P1 GN	10	0,032
yellow			B5P1 GE	BS5P1 GE	BC5P1 GE	10	0,032
blue			B5P1 BL	BS5P1 BL	BC5P1 BL	10	0,032
black			B5P1 SW	BS5P1 SW	BC5P1 SW	10	0,032

Mushroom Heads, Ø40mm



red	0		B5P14 RT-0	BS5P14 RT-0	BC5P14 RT-0	10	0,035
-----	---	--	------------	-------------	-------------	----	-------

EMERGENCY STOP Push Buttons, Ø 28mm, release by turning, with yellow ring



red			B5P3 RT-RGE			10	0,032
red	0		B5P3 RT-0-RGE			10	0,032

EMERGENCY STOP Push Buttons, Ø 40mm, release by turning



red	0		B5P34 RT-0	BS5P34 RT-0	BC5P34 RT-0	10	0,035
-----	---	--	------------	-------------	-------------	----	-------

Yellow Disk for EMERGENCY-STOP Push Buttons, Ø70mm, Thickness 1mm



neutral				B5-7603		1	0,004
with marking NOT-HALT-symbol				B5-7603-S		1	0,004



with marking NOT-AUS				B5-7603-1		1	0,004
with marking EMERGENCY STOP				B5-7603-2		1	0,004

Actuators 30mm

Ring	Knob	Alu	Black	Chrome	Pack pcs.	Weight kg/pc.
------	------	-----	-------	--------	-----------	---------------

Rotary Knobs and Swing Knobs, black IP65



Rotary

maintained 60°						
	Rotary	B5KN2	BS5KN2	BC5KN2	10	0,035
	Swing	B5KRN2	BS5KRN2	BC5KRN2	10	0,035
spring return 60°						
	Rotary	B5KN8	BS5KN8	BC5KN8	10	0,035
	Swing	B5KRN8	BS5KRN8	BC5KRN8	10	0,035
spring return 60°						
	Rotary	B5KN1	BS5KN1	BC5KN1	10	0,035
	Swing	B5KRN1	BS5KRN1	BC5KRN1	10	0,035
spring return 60°						
	Rotary	B5KN3	BS5KN3	BC5KN3	10	0,035
	Swing	B5KRN3	BS5KRN3	BC5KRN3	10	0,035
maintained/spring return 60°						
	Rotary	B5KN6	BS5KN6	BC5KN6	10	0,035
spring return/maintained 60°						
	Rotary	B5KN7	BS5KN7	BC5KN7	10	0,035
maintained 120°						
	Rotary	B5KN9	BS5KN9	BC5KN9	10	0,035
maintained 90° according to EN81						
	Rotary	B5KN10	BS5KN10	BC5KN10	10	0,035



Swing

Illuminated Rotary Knobs and Swing Knobs IP67, clear, lamp max. 1,2W, lamps see page 347



Rotary

maintained 90°						
	Rotary	B5KL2	BS5KL2	BC5KL2	10	0,031
spring return 60°						
	Rotary	B5KL1	BS5KL1	BC5KL1	10	0,031
	Swing	B5KRL1	BS5KRL1	BC5KRL1	10	0,031
maintained 60°						
	Rotary	B5KL3	BS5KL3	BC5KL3	10	0,031
	Swing	B5KRL3	BS5KRL3	BC5KRL3	10	0,031
maintained/spring return 60°						
	Rotary	B5KL6	BS5KL6	BC5KL6	10	0,031





Swing

Toggle IP65



O - I	B5E	BS5E	BC5E	10	0,032
-------	------------	-------------	-------------	----	-------

Actuators and Lens Caps 30mm IP65

Ring	key removeable in	Alu	Black	Chrome	Pack pcs.	Weight kg/pc.
						
						
						

Key Operated Rotary Switch with lock Ronis 455



B3SAR 0

maintained 60°

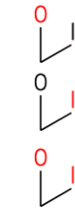

B5SAR 0	BS5SAR 0	BC5SAR 0	1	0,059
B5SAR 1	BS5SAR 1	BC5SAR 1	1	0,059
B5SAR 01	BS5SAR 01	BC5SAR 01	1	0,059



B3SARR 0

spring return 60°



B5SAT 0	BS5SAT 0	BC5SAT 0	1	0,059
---------	----------	----------	---	-------

maintained 60°



B5SARR 0	BS5SARR 0	BC5SARR 0	1	0,059
B5SARR 102	BS5SARR 102	BC5SARR 102	1	0,059

spring return/maintained 60°



B5SATR 02	BS5SATR 02	BC5SATR 02	1	0,059
-----------	------------	------------	---	-------

spring return 60°



B5SATT 0	BS5SATT 0	BC5SATT 0	1	0,059
----------	-----------	-----------	---	-------

Spare Keylock Ronis R455

B4-R455			1	0,007
---------	--	--	---	-------

Colour

Pack
pcs. Weight
kg/pc.

Illuminated Push Buttons IP67, lamp max. 1,9W, lamps see page 347



red	B5DL RT	BS5DL RT	BC5DL RT	10	0,029
green	B5DL GN	BS5DL GN	BC5DL GN	10	0,029
yellow	B5DL GE	BS5DL GE	BC5DL GE	10	0,029
blue	B5DL BL	BS5DL BL	BC5DL BL	10	0,029
white	B5DL WS	BS5DL WS	BC5DL WS	10	0,029

Illuminated Push Buttons IP67, Maintained, lamp max. 1,9W, lamps see page 347



red	B5DLR RT	BS5DLR RT	BC5DLR RT	10	0,029
green	B5DLR GN	BS5DLR GN	BC5DLR GN	10	0,029
yellow	B5DLR GE	BS5DLR GE	BC5DLR GE	10	0,029
blue	B5DLR BL	BS5DLR BL	BC5DLR BL	10	0,029
white	B5DLR WS	BS5DLR WS	BC5DLR WS	10	0,029

Lens Caps with fresnel lens IP67, lamp max. 1,9W, lamps see page 347



red	B5R RT	BS5R RT	BC5R RT	10	0,029
green	B5R GN	BS5R GN	BC5R GN	10	0,029
yellow	B5R GE	BS5R GE	BC5R GE	10	0,029
blue	B5R BL	BS5R BL	BC5R BL	10	0,029
clear	B5R KL	BS5R KL	BC5R KL	10	0,029
white	B5R WS	BS5R WS	BC5R WS	10	0,029

Connectors

Specification	Description	Type	Pack pcs.	Weight kg/pc.
Connector B3S		B3S	10	0,013

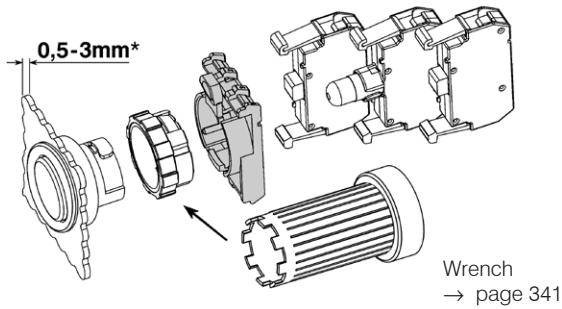

*) inclusive Thickness from Label Holder and Yellow Disk

Contact Blocks and Lamp Holders for Panel Mounting

for voltage	Description	Type	Pack pcs.	Weight kg/pc.
-------------	-------------	------	-----------	---------------

Contact blocks



max. 690V AC	1 NC		B3T01 ²⁾	10	0,010
max. 690V AC	1 NO		B3T10 ²⁾	10	0,010
max. 690V~	1 NC ¹⁾		B3RT01 ²⁾	10	0,010
max. 690V~	1 NO		B3RT10 ²⁾	10	0,010
Actuator insert	to actuate the center contact block		P642	10	0,001

Lamp holders, socket BA9s



max. 440V AC/DC	direct connection, for lamps max. 1,9W (active power consumption)		B3F	10	0,012
-----------------	---	--	-----	----	-------

Lamp holders for lamp test circuits, socket BA9s



max. 440V AC	direct connection, for filament and glow-discharge lamps max. 1,7W (active power consumption)		B3FT	10	0,020
max. 250V	direct connection of LED		B3FTD	10	0,020

1) NC contact has a positive opening according to IEC/EN 60947-5-1

2) Contact blocks with gold contacts (B3T..G) on request suitable for 17V= /1mA and for difficult ambient conditions.

Lamps

Socket BA9s Lamp voltage	Power consumption		Type	Pack pcs.	Weight kg/pc.	
LED lamps²⁾ (6 years middle lifetime, for equivalent lens caps only)						
	20-30V AC/DC	17mA / 0,4W	for red lens caps	B3-L24 RTB	50	0,005
	20-30V AC/DC	17mA / 0,4W	for green lens caps	B3-L24 GNB	50	0,005
	20-30V AC/DC	17mA / 0,4W	for yellow lens caps	B3-L24 GEB	50	0,005
	20-30V AC/DC	17mA / 0,4W	for blue lens caps	B3-L24 BLB	50	0,005
	20-30V AC/DC	17mA / 0,4W	for white lens caps	B3-L24 WSB	50	0,005
	90-120V AC/DC	7mA / 0,8W	for red lens caps	B3-L110 RTB	50	0,005
	90-120V AC/DC	7mA / 0,8W	for green lens caps	B3-L110 GNB	50	0,005
	90-120V AC/DC	7mA / 0,8W	for yellow lens caps	B3-L110 GEB	50	0,005
	90-120V AC/DC	7mA / 0,8W	for blue lens caps	B3-L110 BLB	50	0,005
	90-120V AC/DC	7mA / 0,8W	for white lens caps	B3-L110 WSB	50	0,005
	200-250V AC/DC	4mA / 0,9W	for red lens caps	B3-L230 RTB	50	0,005
	200-250V AC/DC	4mA / 0,9W	for green lens caps	B3-L230 GNB	50	0,005
	200-250V AC/DC	4mA / 0,9W	for yellow lens caps	B3-L230 GEB	50	0,005
	200-250V AC/DC	4mA / 0,9W	for blue lens caps	B3-L230 BLB	50	0,005
	200-250V AC/DC	4mA / 0,9W	for white lens caps	B3-L230 WSB	50	0,005

Filament lamps



24V	1,2W	for all lens caps	B4-G24	100	0,005
42V	1W	for all lens caps	B4-G42	100	0,005
48V	1,2W	for all lens caps	B4-G48	100	0,005
60V	1,2W	for all lens caps	B4-G60	100	0,005
110/120V ¹⁾	1,5/1,8W	for all lens caps	B4-G130	100	0,005

Glow-discharge lamps



220-250V AC	0,3W	for clear, red, yellow lens caps	B4-GL230K	100	0,005
220-250V AC	0,3W	for green, blue lens caps	B4-GL230G	100	0,005

1) Voltage marking 130V / 2W max. rated voltage 120V / 1,8W

2) suitable for B3FT lamp test lamp holders

Accessories



		Type	Pack pcs.	Weight kg/pc.
Wrench	for mounting of actuators and lens caps B(S)3..	J7049	1	0,018
Marking plate	for marking of contact blocks B3T. and lamp holders B3F	P672-1	10	0,001
Lamp Installer	used to install or replace lamps BA9s	B4-7408	1	0,010
Spare Key	for B(S)3SA.. and BS3P44S3, Ronis R455	B4-R455	1	0,007
	for B(S)3SB.., Ronis R786	B4-R786	1	0,007
Protectiv cover sealable	against unintentional manipulation of buttons B5, (not for mushroom heads, rotary and swing knobs)	B5-SAP	1	0,008
Label holder for legend plate BK5, black, 1 or 2 lines		P942-1	10	0,0013
Legend plate BK5 with for label holder P942-1	(with marking e. g.: BK5-MOTOR-START)			
Legend plate alu without marking for label holder P42-1	Text 1 or 2 lines, max. 2 x 13 letters, letter height 3mm	BK5-11374	10	0,0003
Label holder for legend plate BK10, black, 3 or 4 lines		P1043	10	0,0015
Legend plate BK10 with for label holder P1043	(with marking e. g.: BK10-WATER-PUMP-START)			
Legend plate alu without marking for label holder P1043	Text 3 or 4 lines, max. 4 x 13 letters, letter height 3mm	BK10-11724	10	0,0005
Adapter to convert Actuators 22mm to 30mm				
	alu	B5	10	0,017
	black	BS5	10	0,017
	chrome	BC5	10	0,017

Assembled Stations BG.. IP67 Type 12

- A Actuators or Lens caps, see page 325 – 328
- B Legend plates with label holder
- C Ring and nut (included with actuator or lens cap)
- D Contact blocks and lamp holders, see page 344
- E Rear shroud
- F Function number
- G Cover
- H Pre-moulded knockouts in rear wall
- K Captive screws (after screw in), at delivery loose
- L Sign of units at the ground of the rear wall
- M Pre-moulded knockouts for conduit hubs
- N Sequence number
- O Spring-catches for snap in Contact blocks and lamp holders

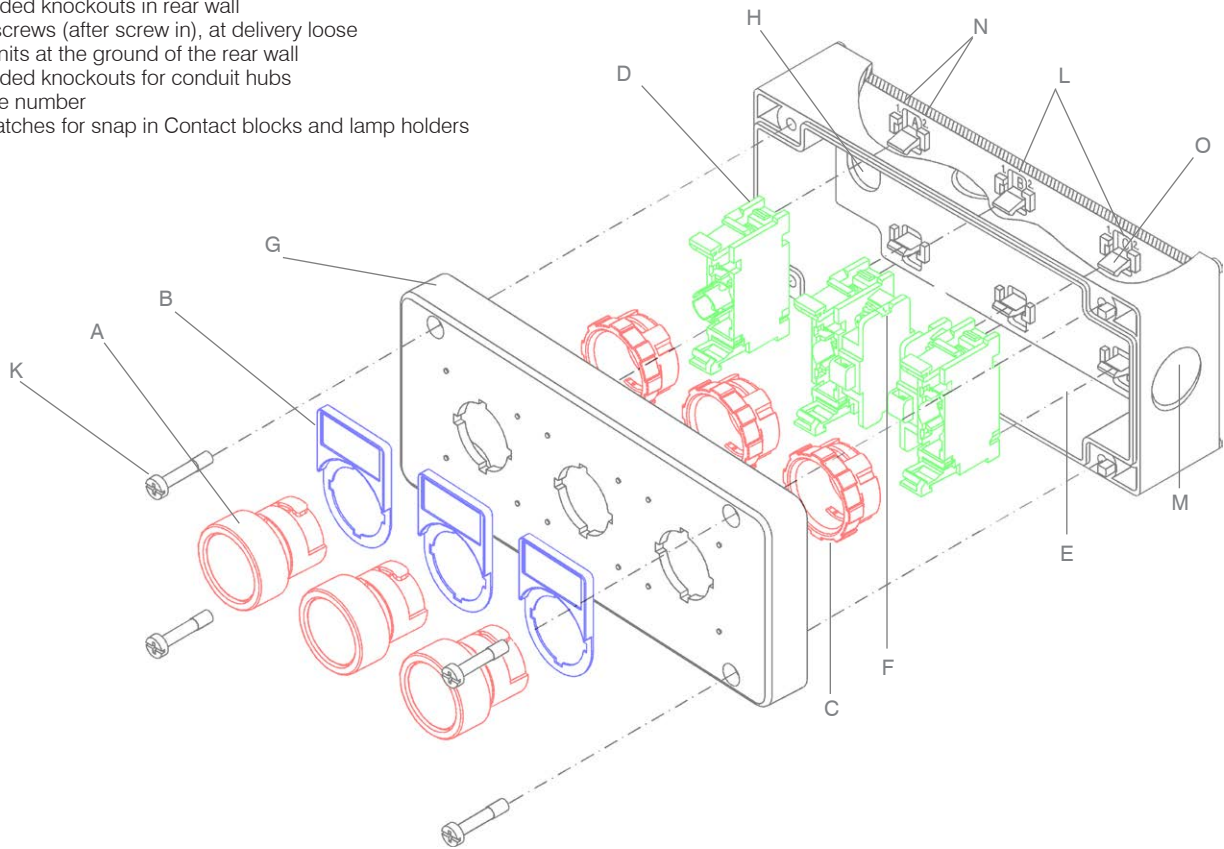

Buttons for base mounting

- A Actuator Ø 22mm see page 325 – 328, Ø 30mm see page 337 – 339
- B Extension B4V...
- C Ring and nut (included with actuator or lens cap)
- D Contact block B4.. see page 344
- E Base B4U for base and DIN-rail mounting of contact blocks

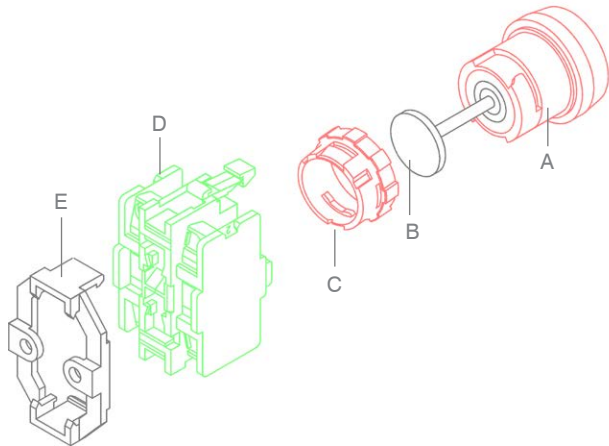





















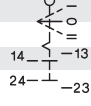



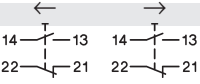

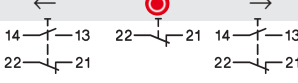

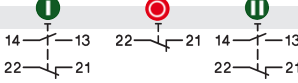

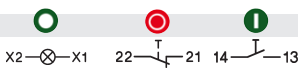
Mounting Plate for base and DIN-rail mounting of contact blocks



	Type	Pack pcs.	Weight kg/pc.
Mounting Plate for base and DIN-rail mounting of contact blocks and lamp holders B4.U...	B4U	10	0,010
Ring and Nut for mounting former actuators and lens caps B4...	B3UP	10	0,004

Assembled Stations IP67 (IP65) Type 12

For conduit entries are in top and both small sides only one knockouts for conduit hubs Ø20,5mm, for M20 or PG13,5 provided.

Type	Diagram	Diagram	Pack pcs.	Weight kg/pc.
Plastic enclosed buttons and Pilot Lights				
	ON push button green		BG10 GN	1 0,135
	OFF push button red		BG10 RT	1 0,135
	Pilot light green		BG01 GN	1 0,135
	Pilot light red		BG01 RT	1 0,135
	Key operated 0 - I ¹⁾ lock Ronis R455 60° maintained		BG10SAR 0	1 0,165
	Key operated I - 0 - II ¹⁾ lock Ronis R455 60° maintained		BG10SARR 0	1 0,172
	2 push buttons 0 - I		BG20	1 0,200
	2 push buttons ← →		BG20PF	1 0,200
	3 push buttons ← 0 →		BG30PF	1 0,283
	3 push buttons I - 0 - II		BG30	1 0,283
	2 push buttons 0 - I with pilot light green		BG21 GN	1 0,270
	Foot and palm button mushroom Ø70mm		BG10P14P GR	1 0,187
Plastic enclosed EMERGENCY STOP buttons				
	EMERGENCY STOP button head Ø40mm unlock by turning		BG10P34-11	1 0,145
	EMERGENCY STOP mushroom button Ø40mm according to EN ISO 13850 unlock by pull		BG10P44-11	1 0,145
	EMERGENCY STOP key operated button Ø40mm according to EN ISO 13850 unlock by key		BG10P44S3-11	1 0,178
	EMERGENCY STOP mushroom button Ø70mm unlock by turning		BG10P34P-11	1 0,187

1) IP65

Enclosures BG.. IP67, Type 12











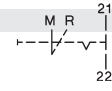

Number of units	Description	Type	Pack pcs.	Weight kg/pc.
1	3 knockouts Ø20,5mm (M20 or PG13,5)	BG1	1	0,108
1 yellow	3 knockouts Ø20,5mm (M20 or PG13,5)	BG1 GE	1	0,108
2	3 knockouts Ø20,5mm (M20 or PG13,5)	BG2	1	0,145
3	3 knockouts Ø20,5mm (M20 or PG13,5)	BG3	1	0,188

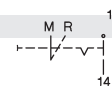
Buttons and Lens Caps B3.. see page 331 -334

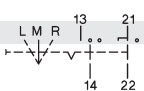

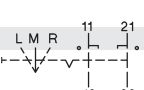

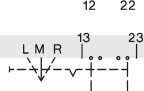





Contact blocks for enclosures BG..

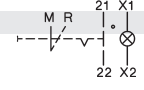

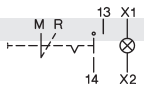
Contacts	Lamp voltage	Wiring diagram	actuators with 2 or 3 switch positions	Type	Pack pcs.	Weight kg/pc.
1NC ¹⁾ 				B4TU01	10	0,015
1NO				B4TU10	10	0,015
1NO+1NC ¹⁾ 				B4TU11	10	0,022
2NC ¹⁾ 				B4TU02	10	0,022
2NO				B4TU20	10	0,022

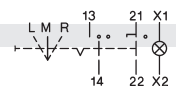
Contact blocks with lamp holder, socket BA9s for LED or lamps, for enclosures BG.., lamps see page 347

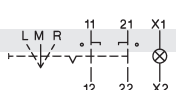

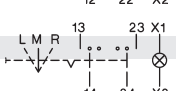
Contacts	Lamp voltage	Wiring diagram	actuators with 2 or 3 switch positions	Type	Pack pcs.	Weight kg/pc.
1NC ¹⁾ 	max. 440V AC/DC			B4TU01F	10	0,020
1NO	max. 440V AC/DC			B4TU10F	10	0,020
1NO+1NC ¹⁾ 	max. 440V AC/DC			B4TU11F	10	0,027
2NC ¹⁾ 	max. 440V AC/DC			B4TU02F	10	0,027
2NO	max. 440V AC/DC			B4TU20F	10	0,027

Lamp holder, socket BA9s for LED or lamps, lamps see page 345

max. 440V AC/DC	direct connection, for lamps max. 1,9W (take care for active power consumption)		B4FU	10	0,013
-----------------	---	---	------	----	-------

1)  NC contact has a positive opening according to IEC/EN 60947-5-1

Accessories for Plastic enclosed buttons



		Type	Pack pcs.	Weight kg/pc.
Wrench and lens caps B(S)3..	for mounting of actuators	J7049	1	0,018
Couple Part	to couple enclosures BKLG or assembled stations BG..	B4-8852	1	0,018

Push Buttons for Enclosures 22mm IP65

Push buttons grey RAL7035



Specification	Colour	Symbol	Length mm	Type	Pack pcs.	Weight kg/pc.
Reset push button	blue	R	8-22	B2GRB-22	10	0,005
	blue	R	22-60	B2GRB-60	10	0,016
Reset push button with stop function	red	0/R	8-22	B2GR-22	10	0,005
	red	0/R	22-60	B2GR-60	10	0,016
Start push button	green	I	8-22	B2GI-22	10	0,005
	green	I	22-60	B2GI-60	10	0,016
Stop push button	red	0	8-22	B2G0-22	10	0,005
	red	0	22-60	B2G0-60	10	0,016
Mushroom head lockable Ø28mm	red	0	8-22	B2GP-22	10	0,005
	red	0	22-60	B2GP-60	10	0,016

Push buttons with metal ring and self adjusting extension pin



Reset push button	blue	R	19,5-38,5	B3GRB-31,5	10	0,023
	blue	R	38,5-60	B3GRB-60	10	0,026
Reset push button with stop function	red	0/R	19,5-38,5	B3GR-31,5	10	0,023
	red	0/R	38,5-60	B3GR-60	10	0,026
Start push button	green	I	19,5-38,5	B3GI-31,5	10	0,023
	green	I	38,5-60	B3GI-60	10	0,026
Stop push button	red	0	19,5-38,5	B3G0-31,5	10	0,023
	red	0	38,5-60	B3G0-60	10	0,026

Specification	Diameter Ø mm	Length mm	Type	Pack pcs.	Weight kg/pc.
---------------	---------------	-----------	------	-----------	---------------

Extensions for push buttons



self adjusting pin, for B(S, C)3D.. and B(S, C)3P..	15	19,5 - 38,5	B4V31,5	10	0,001
	18,5	38,5 - 60	B4V60	10	0,004

Technical Data

Terminal markings for control units according to DIN EN 50013

Distinc. number	Contact elements	Distinc. number	Contact elements	Distinc. number	Contact elements	Distinc. number	Contact elements	Distinc. number	Contact elements	Colour code
10	13 14							01	21 22	 <p>NO Green</p> <p>NC Red</p>
20	13 23 14 24	11	13 21 14 22					02	11 21 12 22	
30	13 23 33 14 24 34	21	13 21 33 14 22 34	12	13 21 31 14 22 32			03	12 22 32 12 22 32	
40	13 23 33 43 14 24 34 44	31	13 21 33 43 14 22 34 44	22	13 21 31 43 14 22 32 44	13	13 21 31 41 14 22 32 42	04	11 21 31 41 12 22 32 42	

Data according to IEC 947-5-1, VDE 0660, EN 60947-5-1

Type		B3T	B4T
Rated insulation voltage U_i	V AC	690 ¹⁾	500
Utilization category AC12 Control of resistive loads and solid stateloads with isolation by opto couplers			
Rated current I_e	220-240V A 380-415V A 500V A 690V A	10 10 10 10	10 10 10 -
Utilization category AC15 Control of electromagnetic load (>72VA)			
Rated current I_e	220-240V A 380-415V A 500V A 690V A	6 5 3 2	6 5 3 -
Utilization category DC12 L/R = 1ms Control of resistive loads and solid stateloads with isolation by opto couplers			
Rated current I_e	24V A 60V A 110V A 220V A	10 6 2,5 0,8	10 6 2,5 0,8
Utilization category DC14 L/R = 15ms Control of electromagnetic loads having economy resistors in circuit			
Rated current I_e	24V A 60V A 110V A 220V A	8 1 2 0,5	8 1 2 0,5
Utilization category DC13 L/R = 300ms Control of electromagnets			
Rated current I_e	24V A 60V A 110V A 220V A	2 5 0,5 0,2	2 5 0,5 0,2
Making capacity	A	60	60
Breaking capacity $\cos\phi = 0,7-1$	40-60Hz A	50	50
Mechanical life	millions of operations	10	10
Contact life (AC15)			
100VA	millions of operations	10	10
300VA	millions of operations	3	3
800VA	millions of operations	1	1
1200VA	millions of operations	0,5	0,5
Maximum frequency of operations	ops. per hour	600	600
Short circuit protection	slow, gL (gG) A	25	25



Type		B3F	B4F
Rated insulation voltage U_i	V AC	440 ²⁾	440 ²⁾
Lamp base		BA9s	

Type		B3., B4., B5.
Protection degree (according to IEC 947-1) in assembled state, from the front from rear		IP67/IP65 IP20/IP00
Ambient temperature	°C	-40 to +50
Cable cross-section		
	solid, mm ² flexible, mm ² flexible with multicore cable end, mm ² number	0,5 - 2,5 0,5 - 2,5 0,5 - 1,5 2
Cables per clamp		2
Mounting hole (according to IEC 947-1)	Ø mm Ø mm	22,5 30,5
Mounting position		optional
Terminal screws		Pozidriv No. 2 screws M3,5

Data according to cULus

Type	B3.	B4.
Contact Block for NO and NC	600 V AC max.	600 V AC max.
General use	10A	10A
Heavy pilot duty	A600	A600
Lamp Holder with socket BA9s	240V 2,6W max.	240V 2,6W max.
Wire (Contact and lamp holder)	14 - 18AWG 9 lb/in.	14 - 18AWG 9 lb/in.
Torque		

Approvals

Country	USA, Canada UL	Europe CE	Register of Shipping Great Britain LRS	CENELEC CB- Certificates
Type				
B3T.	o	o	-	o
B3F.	o	o	-	o
B4TU..	o	o	o	o
B4T..UF	o	o	o	o
B4FU..	o	o	o	o
B3-MB..	-	o	-	-

o In standard version approved

- Not provided for test till now

1) suitable for: earthed-neutral systems, overvoltage category I to IV, pollution degree 3 (standard-industry): $U_{mp} = 6kV$. Data for other conditions on request

2) suitable for: earthed-neutral systems, overvoltage category I to III, pollution degree 3 (standard-industry): $U_{mp} = 4kV$

Dimensions

Actuators and Lens Caps 22mm

Panel mounting B3S

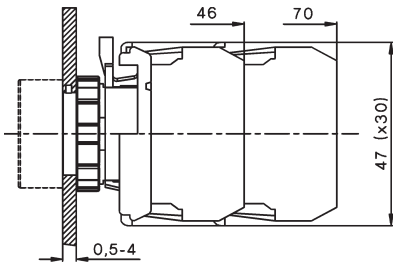

Panel mounting B3M

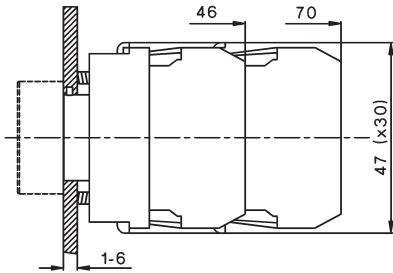

Mounting holes

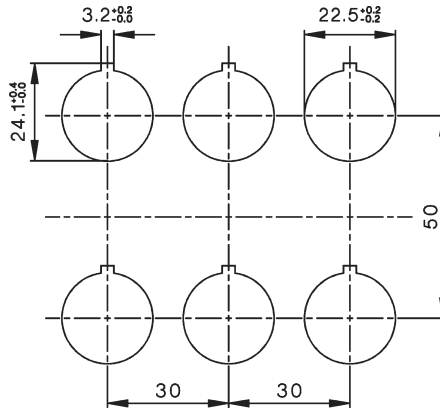

Contact blocks and Lamp Holder B3...

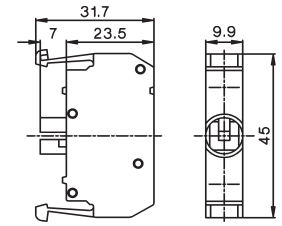

Dimensions of minimum space requirements according to IEC. Take to consideration the field of traverse of swing knobs (27mm) and the diameter of mushroom heads.

Actuators and Lens caps

Flush Head
Illuminated Flush Head

B3D(R), B3DL(R)
BS3D(R), BS3DL(R)
BC3D(R), BC3DL(R)

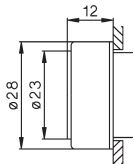

Mushroom Head Ø28mm
Emergency Stop Ø28mm

B3P1 bis B3P3
BS3P1 bis BS3P3
BC3P1 bis BC3P3

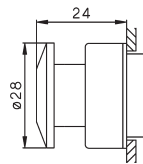

Mushroom Head Ø40mm
Emergency Stop Ø40mm

B3P14, B3P34
BS3P14, BS3P34
BC3P14, BC3P34

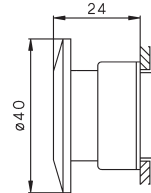

Mushroom Head Ø70mm
Emergency Stop Ø70mm

BS3P14P
BS3P34P

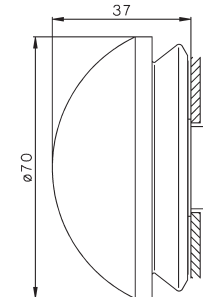

Push-and pull button Ø40mm

BS3P44

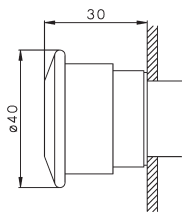

Push-and pull button Ø40mm

BS3P45

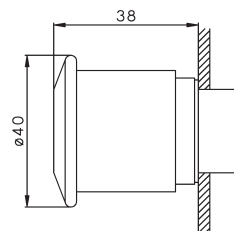

Push-and pull button Ø40mm
with key

BS3P44S3

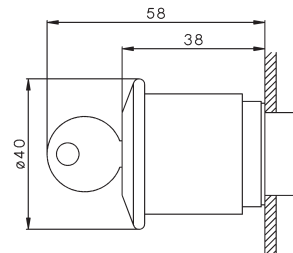

Lockable Push button

B3SAR., B3SAT.
BS3SAR., BS3SAT.
BC3SAR., BC3SAT.

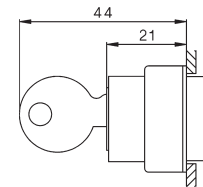

Toggle

B3E
BS3E
BC3E

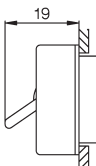

Rotary Knob

B3KN, B3KL
BS3KN, BS3KL
BC3KN, BC3KL

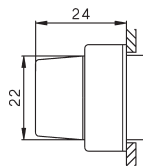

Swing Knob

B3KRL, B3KRN
BS3KRL, BS3KRN
BC3KRL, BC3KRN

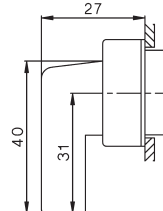

Lens Cap

B3R(F) B3RN

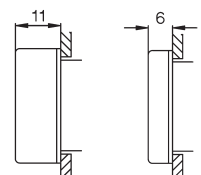

Dimensions

Actuators and Lens Caps 22mm

Double push button

Monoblock Multi-LED

Protection cover

Protection ring w. thread

B3DT

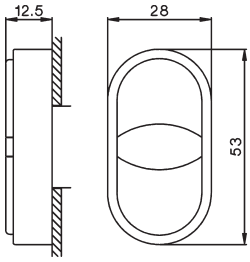

B3-MB...

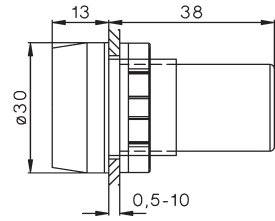

B3-SK ..

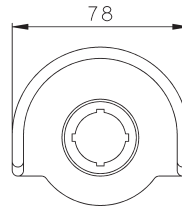
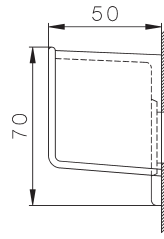

P921-.

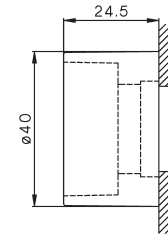

Label holder

Legend plate

Label holder

Label holder

Legend plate

P751

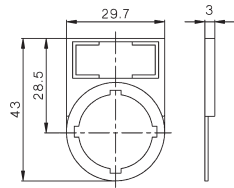

BK4-...

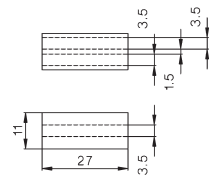

P761

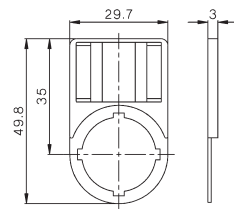

P761-DT

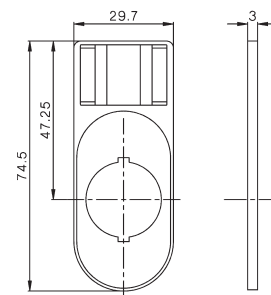

BK8-...

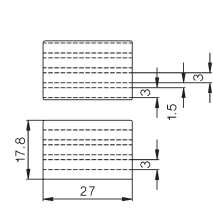

Dimensions

Actuators and Lens Caps 30mm

Panel mounting B3S

Mounting holes

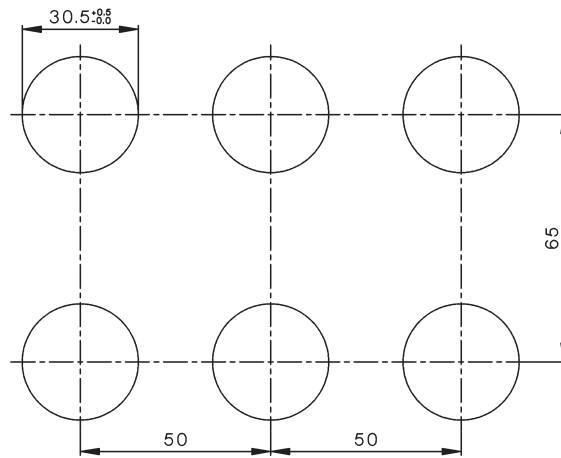
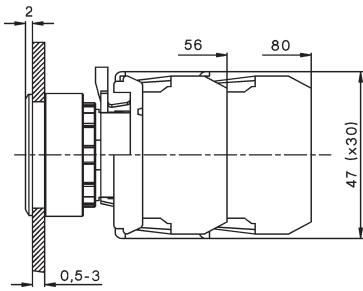

Actuators and Lens caps

Flush Head Illuminated Flush Head	Mushroom Head Ø28mm Emergency Stop Ø28mm	Mushroom Head Ø40mm Emergency Stop Ø40mm	Lens Cap
--------------------------------------	---	---	----------

B5D(R), B5DL(R)
BS5D(R), BS5DL(R)

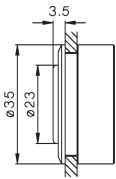

B5P1 to B5P3
BS5P1 to BS5P3

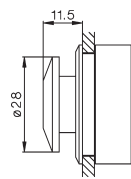

B5P14, B5P34
BS5P14, BS5P34

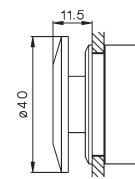

B5RF

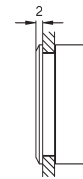

Toggle

Rotary Knob

Swing Knob

Lockable Push button

B5E
BS5E

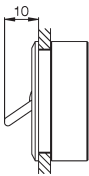

B5KN, B5KL
BS5KN, BS5KL

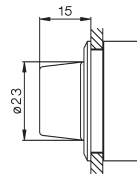

B5KRL, B5KRN
BS5KRL, BS5KRN

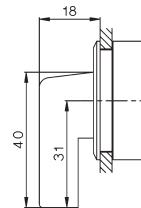

B5SAR., B5SAT.
BS5SAR., BS5SAT.

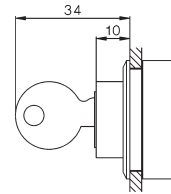

Label holder

Legend plate

Label holder

Legend plate

P942-1

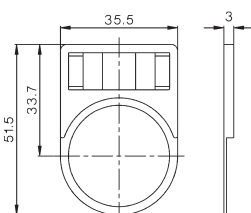

BK5-...

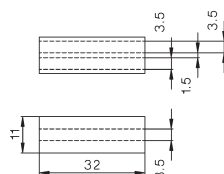

P1043

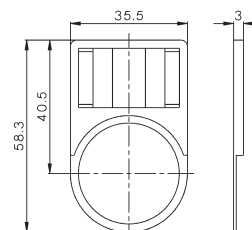

BK10-..

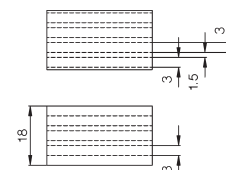

Dimensions

Protective Cover
B5-SAP

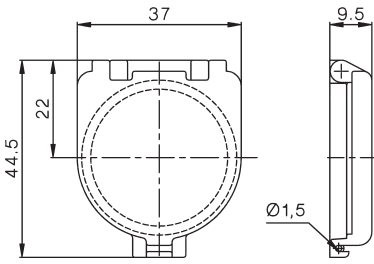

Enclosures for Custom Built Stations

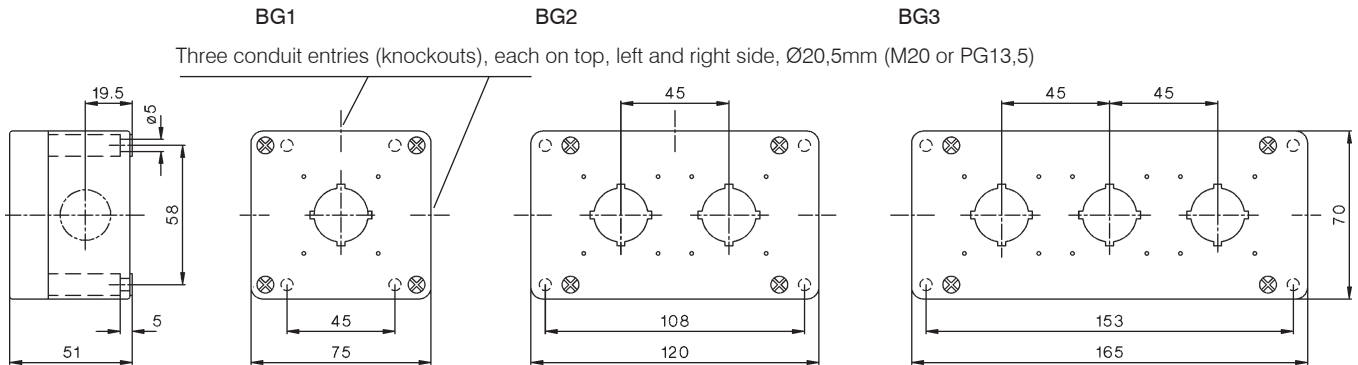

Conduit entries in the bottom
(knockouts)

Coupled Enclosures
B4-8852

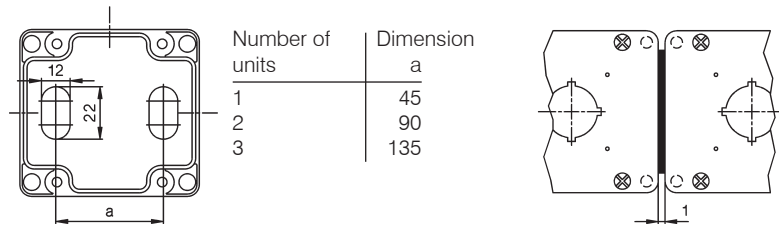

EMERGENCY STOP Push Button Ø40 mm

BG10P44

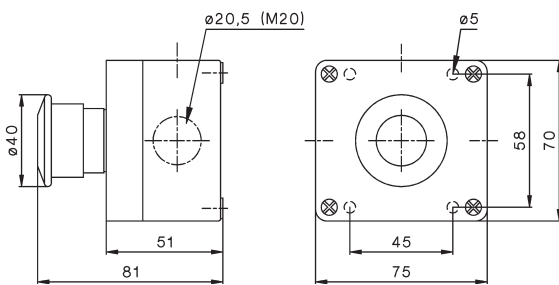

EMERGENCY STOP Push Button Ø70 mm, Foot switch

BG10P34P, BG10P14P

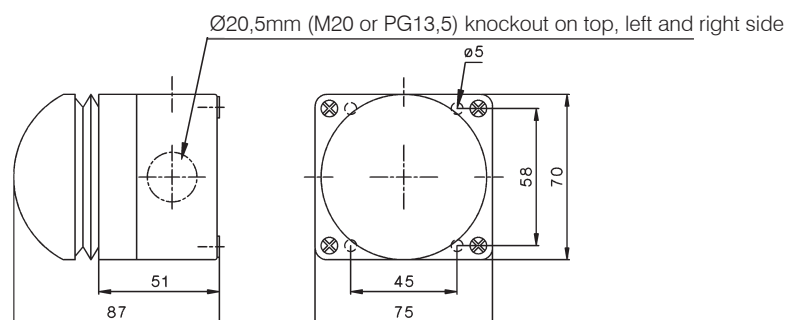

Dimensions

Actuators 22mm

Base mounting

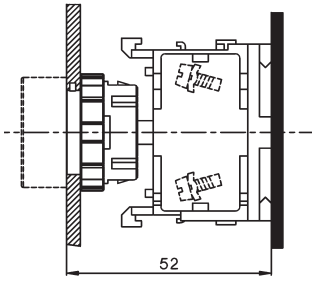

DIN-rail mounting

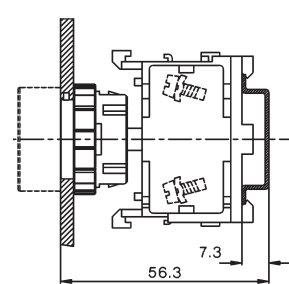

Contact blocks and Lamp Holders B4.U...

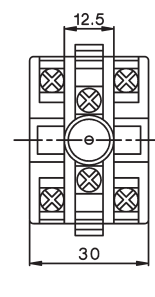
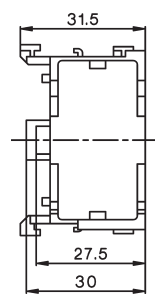

Base B4U

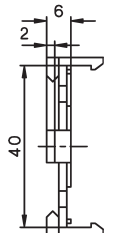
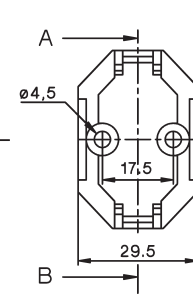

Push buttons for enclosures

B2G...-22

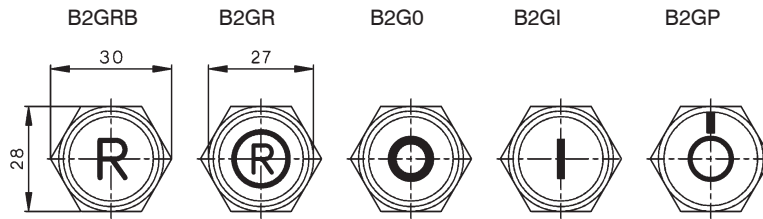
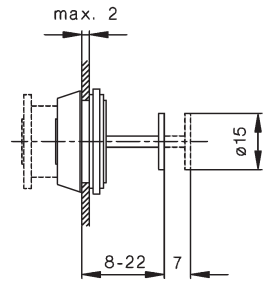

B2G...-60

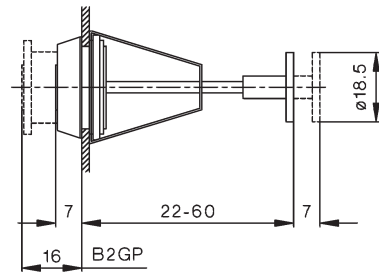

B3G...-31,5

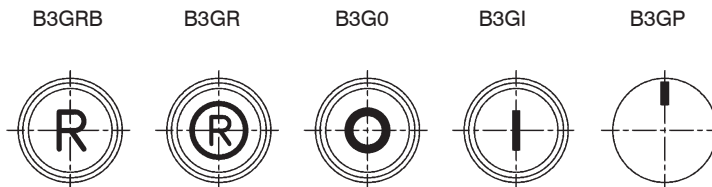
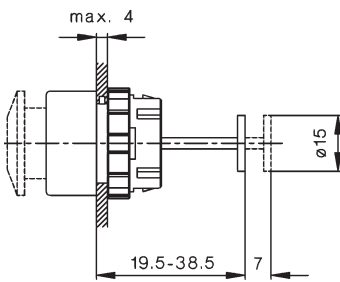

B3G...-60

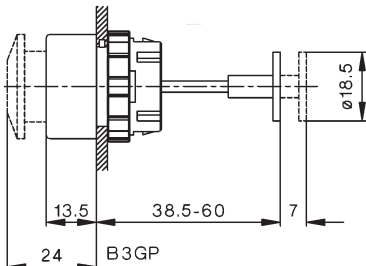

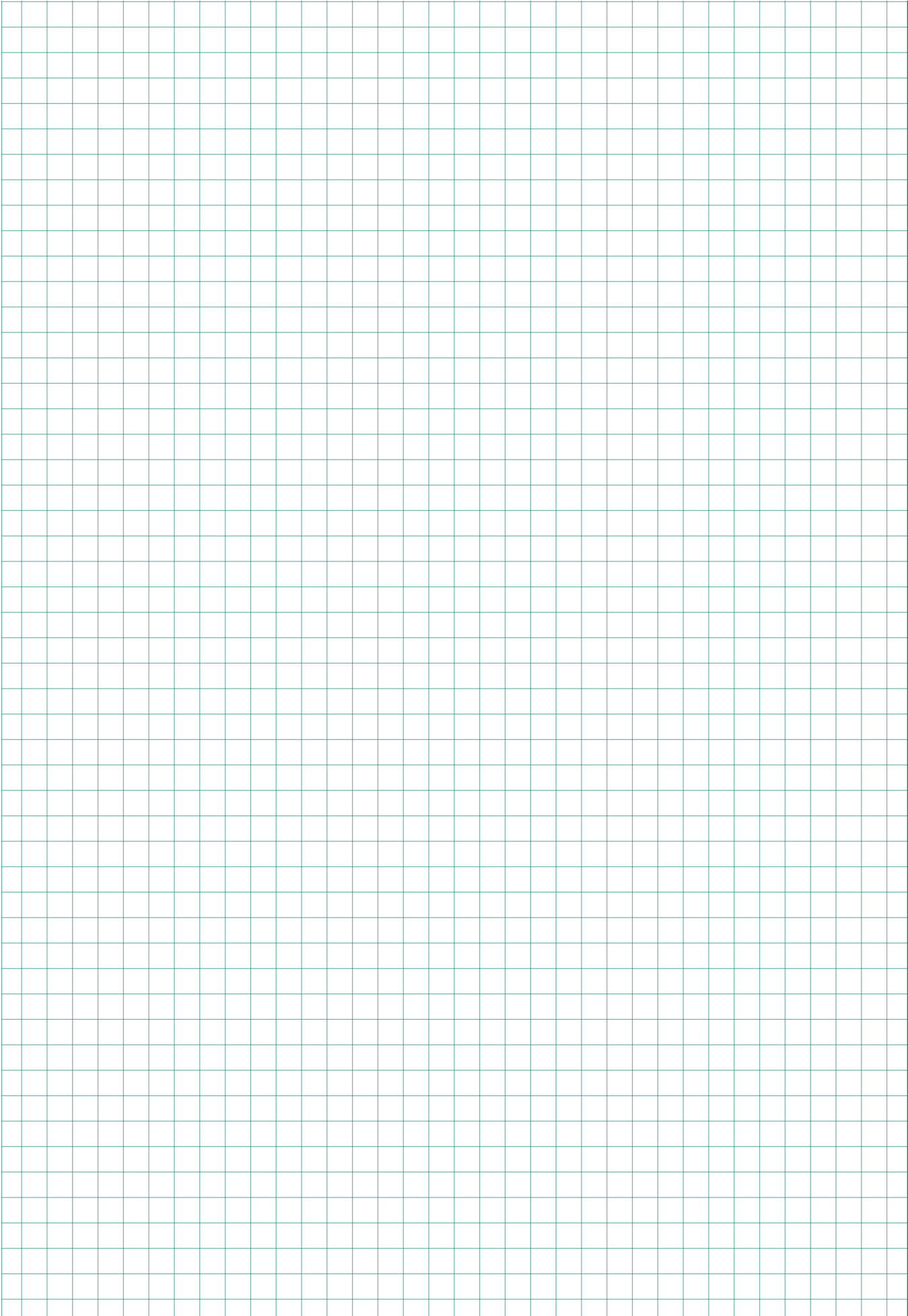

Austria

Kiechel & Hagleitner GmbH & Co KG Tel: +43 / 5574 / 4970-53
 Quellenstraße 20-22 Fax: +43 / 5574 / 4970-20
 6900 Bregenz monika.simma@kiha.at
 Representation for Vorarlberg www.kiha.at

Blasy GmbH Tel: +43 512 244 95 90
 Bundesstrasse 29 Fax: + 43 512 244 95 41
 6063 Rum office.electro@blasy.at
 Representation for Tirol www.blasy.at

Seitner & Bittmann Tel: +43 / 316 / 82 35 62
 Kossogasse 21 Fax: +43 / 316 / 82 35 65
 8035 Graz info@seitner-bittmann.at
 Representation for Styria www.seitner-bittmann.at

Seitner & Bittmann Tel: +47 / 463 / 38 10 70
 Kirchengasse 11 Fax: +47 / 463 / 38 10 72
 9020 Klagenfurt info@seitner-bittmann.at
 www.seitner-bittmann.at

STARA Elektrogroßhandel GmbH Tel: +43 / 732 / 380841-0
 Hollaberstraße 7 Fax: +43 / 732 / 380841-24
 4020 Linz verk.li@stara.at
 www.stara.at

Gebrüder LIMMERT AG Tel: +43 / 662 / 88933-0
 Samergasse 30a Fax: +43 / 662 / 881254
 Postfach 168 verkauf-allgemein@limmert.com
 5020 Salzburg www.limmert.com

GFI Elektrofachgroßhandel Tel: +43 / 1 / 7265200-0
 Oberlaaer Strasse 285 Fax: +43 / 1 / 7265200-20
 1230 Wien servicecenter@gfi-austria.at
 www.gfi-elektro.at

Sonepar Österreich GmbH Tel: +43 / 1 / 291 26-0
 Prager Strasse 243 Fax: +43 / 1 / 291 26-835
 1210 Wien www.sonepar.at

REGRO Elektro-Grosshandel GmbH Tel: +43 / 5 / 734 76-0
 Muthgasse 26/5 Fax: +43 / 5 / 734 76-58082
 1190 Wien www.regro.at

Rexel Austria GmbH Tel: +43 / 1 / 688 0 388 30
 Murbangasse 1 office@rexel.at
 1100 Wien www.rexel.at

**Schäcke Elektrogroßhandels-
 gesellschaft m.b.H.** Tel: +43 / 5 / 01210 13
 Murbangasse 1 www.schaecke.at
 1100 Wien

Sonepar Österreich GmbH Tel: +43 / 51706-0
 Großmarktstraße 7b Fax: +43 / 51706-70500
 1230 Wien info@sonepar.at
 www.sonepar.at

STARA Elektrogroßhandels GmbH Tel. Linz: +43 / 732 / 380841-0
 Autokaderstraße 31 Fax Linz: +43 / 732 / 380841-24
 1210 Wien wien@stara.at
 Tel. Vienna: +43 / 1 / 6992619-0 verk.li@stara.at
 Fax Vienna: +43 / 1 / 6992619-18 verw.li@stara.at
 www.stara.at

TEG GmbH Tel: +43 / 1 / 5 96 36 92
 Richard-Strauss-Str. 15 Fax: +43 / 1 / 5 96 36 92 92
 1230 Wien office@teg.at
 www.teg.at

Belgium

Teconex Tel: +32 / 4 / 358 85 75
 Matériel Electrique axel.bervoets@teconex.be
 Rue de Magnée 108 www.teconex.eu
 B - 4610 Beyne-Heusay

Bulgaria

Schrabul Ltd Tel: +359 / 02 / 958 76 54
 Yordan Yovkov Str. 8 Fax: +359 / 02 / 958 59 95
 BG - 1408 Sofia info@schrabul.com
 www.schrabul.com

Croatia

Stirel Promet d.o.o. Tel: +385 / 1 / 364 9260
 Ulica Vladimira Varicaka 3 Fax: +385 / 1 / 364 9360
 HR - 10000 Zagreb info@stirel-promet.hr
 www.stirel-promet.hr

Tipteh d.o.o. Zagreb Tel: +385 / 1 / 314 1550
 Ratarska 35 Fax: +385 / 1 / 314 1551
 HR - 10000 Zagreb tipteh@tipteh.hr
 www.tipteh.hr

Cyprus

M. Hadjoannou Ltd. Tel: +357 / 22 / 348 262
 Electrotechnical & Lighting Specialists Fax: +357 / 22 / 430 107
 Aegeos 8c, Pallouriotissa milton@spidernet.com.cy
 CY - Nicosia

Czech Republic

DNA Energie spol s.r.o. Tel: +420 / 327 316 339
 Kmochova 406 Fax: +420 / 327 316 405
 CZ - 280 02 Kolin 2 martin.pecha@dna.cz
 www.dna.cz

Denmark

MTO electric a/s Tel: +45 / 75 800 310
 Stiftsvej 14 Fax: +45 / 75 800 320
 DK - 7100 Vejle info@mto-electric.dk
 www.mto-electric.dk

Finland

UTU Powel Oy Tel: +358 / 9 / 274 64 128
 Valimotie 26B Fax: +358 / 9 / 274 64 141
 PL 252 harri.paivarinta@utu.eu
 FIN - 01531 Vantaa www.utu.eu

France

Teconex Tel: +32 / 4 / 358 85 75
 Matériel Electrique
 Rue de Magnée 108 axel.bervoets@teconex.be
 B - 4610 Beyne-Heusay www.teconex.eu

Germany

TVB - ENSYPA GmbH Tel: +49 / 40 / 671 021 70
 Neuer Höltingbaum 36 Fax: +49 / 40 / 671 021 769
 D - 22143 Hamburg www.tvb-ensypa.com
 info@tvb-ensypa.com

*Representation for Schleswig-Holstein, Hamburg, Mecklenburg-
 Vorpommern, Niedersachsen*

ELWATEG Elektrohandel GmbH & Co KG
 Am Südfeld 7 Tel: +49 / 4441 / 9170 0
 D - 49377 Vechta Fax: +49 / 4441 / 9170 70
 www.elwateg.de
 vertrieb@elwateg.de

*Representation for Niedersachsen: Vechta, Cloppenburg, Diepholz,
 Osnabrück, Oldenburg, Bremen, Emsland*

Messtechnik GmbH Tel: +49 / 341 / 5 50 16 06
 Rudolf Kiesewetter Fax: +49 / 341 / 5 50 16 09
 Prager Straße 34 info@kiesewetter-mt.de
 D - 04317 Leipzig www.kiesewetter-mt.de

Representation for Brandenburg, Sachsen-Anhalt, Sachsen, Thüringen

SBV - Gawehn GmbH
Industrievertretungen
Zollnerstraße 2
D - 90579 Langenzenn
Representation for Bayern

Tel: +49 / 9101 / 9099-0
Fax: +49 / 9101 / 9099-30
vertrieb@gawehn.com
www.gawehn.com

Great Britain

IMO Precision Controls Ltd.
The Interchange 7530
Frobisher Way, Hatfield
GB - AL10 9TG Hertfordshire

Tel: +44 / 0 / 1707 414 444
Fax: +44 / 0 / 1707 414 445
imo@imopc.com
www.imopc.com

Greece

Geyer Hellas s.a.
Electrical and Electronic Material
PO Box 19038
GR - 34100 Drosia-Chalkis

Tel: +30 / 22210 / 987 11
Fax: +30 / 22210 / 987 12
info@geyer.gr
www.geyer.gr

Hungaria

DIAL-COMP Kft.
Kámfor u. 31. a-b
H - 1131 Budapest

Tel: +36 / 1 / 236 0427
Fax: +36 / 1 / 236 0430
info@dialcomp.hu
www.dialcomp.hu

Italy

SIF sas
Via del Carraccio 104/1
I - 24040 Stezzano

Tel: +39 / 35 / 592 931
Fax: +39 / 35 / 455 93 58
info@sifmdc.com

Netherlands

Hirsch-Driebergen B.V.
Postbus 143
NL - 3970 AC Driebergen

Tel: +31 / 343 / 51 55 34
Fax: +31 / 343 / 52 03 14
info@hirsch-driebergen.nl
www.hirsch-driebergen.nl

Norway

Gylling Teknikk AS
P. O. Box 103
Rudssletta 71
N - 1351 Rud

Tel: +47 / 67 / 15 14 00
Fax: +47 / 67 / 15 14 01
gylling@gylling.no
www.gylling.no

Poland

ASTAT Sp. z o.o.
ul. Dabrowskiego 441
PL - 60-451 Poznań

Tel: +48 / 61 / 848 88 71
Fax: +48 / 61 / 848 82 76
info@astat.com.pl
www.astat.com.pl

Portugal

Jayme da Costa
Mecanica e Electricidade, S.A.
Rua de Murraceses, 216
P - 4416 - 901 Pedroso

Tel: +351 / 22 / 74 70 250
Fax: +351 / 22 / 76 40 548
ae@jaymedacosta.pt
www.jaymedacosta.pt

Romania

Megatech Trading & Consulting SRL
Str. Buzesti 61, Bl.A6, Sc. 1, Et.6
RO - Bukarest 1

Tel: +40 / 21 / 317 05 68
Fax: +40 / 21 / 317 05 68
sales@megatech.ro
http://www.megatech.ro

Russia

Poligon
офис 501, ул. Льва Толст
197376 Санкт-Петербург
Россия

Tel: +7 / 812 / 335 3665
Fax: +7 / 812 / 325 4220
www.poligon.info

TsUP ChEAZ
(ChEAZ Center for Project
Management)
ul. Dokukina, 16/1
Moscow
RU-129226 Russia

Tel: +7 495 6603100
Fax: +7 495 6602138
info@cfpm.ru
www.cheaz.ru

Slovakia

DNA Slovakia s.r.o.
Komárňanská cesta 13
SK - 940 43 Nové Zámky

Tel: +35 / 6400 616, 6426 824
Fax: +35 / 6401 907
info@dnaslovakia.sk
www.dnaslovakia.sk

Slovenia

Tipteh d.o.o.
Ulica Ivana Roba 21
SI - 1000 Ljubljana

Tel: +386 / 1 / 200 51 50
Fax: +386 / 1 / 200 51 51
info@tipteh.si
www.tipteh.si

Spain

CYDESA
Pol. Ind. Sant Antoni
Parcela 2, Nave A
E - 08620 Sant Vicenc dels Horts

Tel: +34 / 93 / 656 59 50
Fax: +34 / 93 / 676 97 45
cydesa@cydesa.com
www.cydesa.com

Sweden

Wallin & Co AB
Götlundagatan 10
S - 12471 Bandhagen

Tel: +46 / 8 / 860 102
Fax: +46 / 8 / 997 050
info@wallin-co.se
www.wallin-co.se

Switzerland

BENEDICT Swiss AG
Grindelstraße 19
CH - 8303 Bassersdorf

Tel: +41 / 44 / 213 66 00
Fax: +41 / 44 / 213 66 09
office@benedict-swiss.ch
www.benedict-swiss.ch

Serbia and Montenegro

Tipteh d.o.o. Beograd
Ulica Mose Pijade 17A
RS - 11224 Vrcin

Tel: +381 / 11 / 31 31 057
Fax: +381 / 11 / 30 18 326
office@tipteh.rs
www.tipteh.rs

Turkey

ERGUN ELEKTRIK Co Ltd.
Kazim Dirik Mahallesi
Sanayi Caddesi No: 66
Bornova, Izmir
35100 Turkey

Tel: +90 / 232 462 72 00
Fax: +90 / 232 462 72 04
ergun@ergunelektrik.com
www.ergunelektrik.com

Australia

IMO Pacific Pty Ltd
1/6 Dillington Pass
Landsdale
WA 6065
Australia

Tel: +61 / 08 / 9302 5246
Fax: +61 / 8 / 9303 9908
sales@imopacific.com.au
www.imopacific.com.au

Argentina

RHONA Argentina
Bahia Blanca #5675,
(1650) Munro, Vicente Lopez,
Provincia de Buenos Aires
Argentina

Tel: +54 / 11 / 204 63 64
www.rhona.com.ar

Bolivia

Agencias Generales S.A.
Calle Bolivar E-520

Tel: +591 / 04-4251062
Fax: +591 / 4-4251062
arturo@agsa.com
www.agsa.com

BO - 0253 Cochabamba

Canada

BROOK CROMPTON LTD:
264 Attwell Drive
Toronto, ON
CDN - M9W 5B2

Tel: +1 / 416 / 675 38 44
Fax: +1 / 416 / 675 68 85
david.tomlinson@brookcromptonna.com
www.brookcromptonna.com

Chile

RHONA S.A.
Agua Santa 4211
Vina del Mar
Chile

Tel: +56 / 32 / 2320600
info@rhona.cl
www.rhona.cl

Egypt

Economic Co.
Electrical Commerce & Import
44, Naguib El-Rihani St.
ET - Kairo

Tel: +20 / 02 / 592 91 80
Fax: +20 / 02 / 590 78 82
economic@economic-ec.com

Hong Kong

**Creation Building Services
Materials Limited**
Unit A & B, 15th Floor, Worldwide Centre
123 Tung Chau Street, Tai Kok Tsui,
Kowloon
Hong Kong - China SAR

Tel: +852 / 2398 2106
Fax: +852 / 2191 5808
sales@creation-trading.com
www.creation-trading.com

Kenia

G.F. Corvin Ltd.
P.O. Box 30747
00100 Nairobi
Kenia

Tel: +254 / 20 / 856 06 08
Fax: +254 / 20 / 856 19 74
gecor@africaonline.co.ke

Lebanon

Industrial Technologies. S.A.L. (itec)
Afrah PLAZA Center
Blvd Fouad Chehab,
Sin El Fil, Beirut

Tel: +961 / 1 491 161
Fax: +961 / 1 491 162
info@iteclb.com
www.iteclb.com

Mexico

B&J USA Inc.
120-101 North Tech Drive
Post Office Box 877
Clayton, N.C. 27528

Tel: +52 / 800 989 73 57
Fax: +52 / 919 / 553 5565
sales@bnj-usa.com
www.bnj-usa.com

New Zealand

Eurotec Instruments Ltd.
P.O.Box 14-543 Panmure
750 Gt South Rd, Penrose
NZ - Auckland

Tel: +64 / 9 / 579 1990
Fax: +64 / 9 / 525 3334
sales@eurotec.co.nz
www.eurotec.co.nz

Peru

RHONA Peru S.A.C.
Calle 6D, manzana III lote 1-A
Ciudad del Pecador
Bellaivta, Callao
Peru

www.rhona.pe

Singapore

Mecomb Singapore Ltd.
#04-02 Sime Darby Center
896 Dunearn Road
SGP - 589472 Singapore

Tel: +65 / 646 / 98 833
Fax: +65 / 646 / 71 905
sales.msl@simedarby.com.sg

South Africa

Deebar
Mining & Ind. Supplies
P.O. Box 40325
RSA - 2022 Cleveland

Tel: +27 / 21 / 873 43 32
Fax: +27 / 21 / 825 69 84
sales@deebars.co.za

Electric Assemblies
Unit 2A Simplex Ind. Park
Engine Road,
RSA - 7441 Cape Town

Tel: +27 / 21 / 52 3023
Fax: +27 / 21 / 52 2704
davecpt@mweb.co.za

Syria

T. S. Boyadjian
Electrical Equipments
Halbouni Street no. 9
P.O. Box 2822
SYR - Damaskus

Tel: +963 / 11 / 221 14 45
Fax: +963 / 11 / 221 67 45
tsboyadjian@excite.com

Taiwan

VINMAJOR ENTERPRISE Co., LTD.
8F-2, No. 306, Section 1, Ta-Tung Road
Hsi-Chih, Taipei Hsien
R.O.C. Taiwan

Tel: +886 / 2 / 2643 6183
Fax: +886 / 2 / 8691 6288
vin.major@msa.hinet.net

UAE

JIS Electrical LLC (former DOEPKE)
Saheel Tower 2, Suite 1103
Al Nahda 1 - Al Ittihad Road
P.O.Box 48767 Dubai

Tel: +971 / 4 4277 207
Fax: +971 / 4 4277 208
info@jiselectric.com
www.jiselectric.com

USA

B&J USA Inc.
120-101 North Tech Drive
Post Office Box 877
Clayton, N.C. 27528

Tel: +1 / 800 989 7357
Fax: +1 / 919 / 553 5565
sales@bnj-usa.com
www.bnj-usa.com

Zimbabwe

Star Delta Electrix
No 2 Bristol Road South
Belmont East
P.O. Box 3592
ZW - Bulawayo

Tel: +263 / 9 / 715 24
Fax: +263 / 9 / 764 75
info@stardelta.co.zw
www.stardelta.net

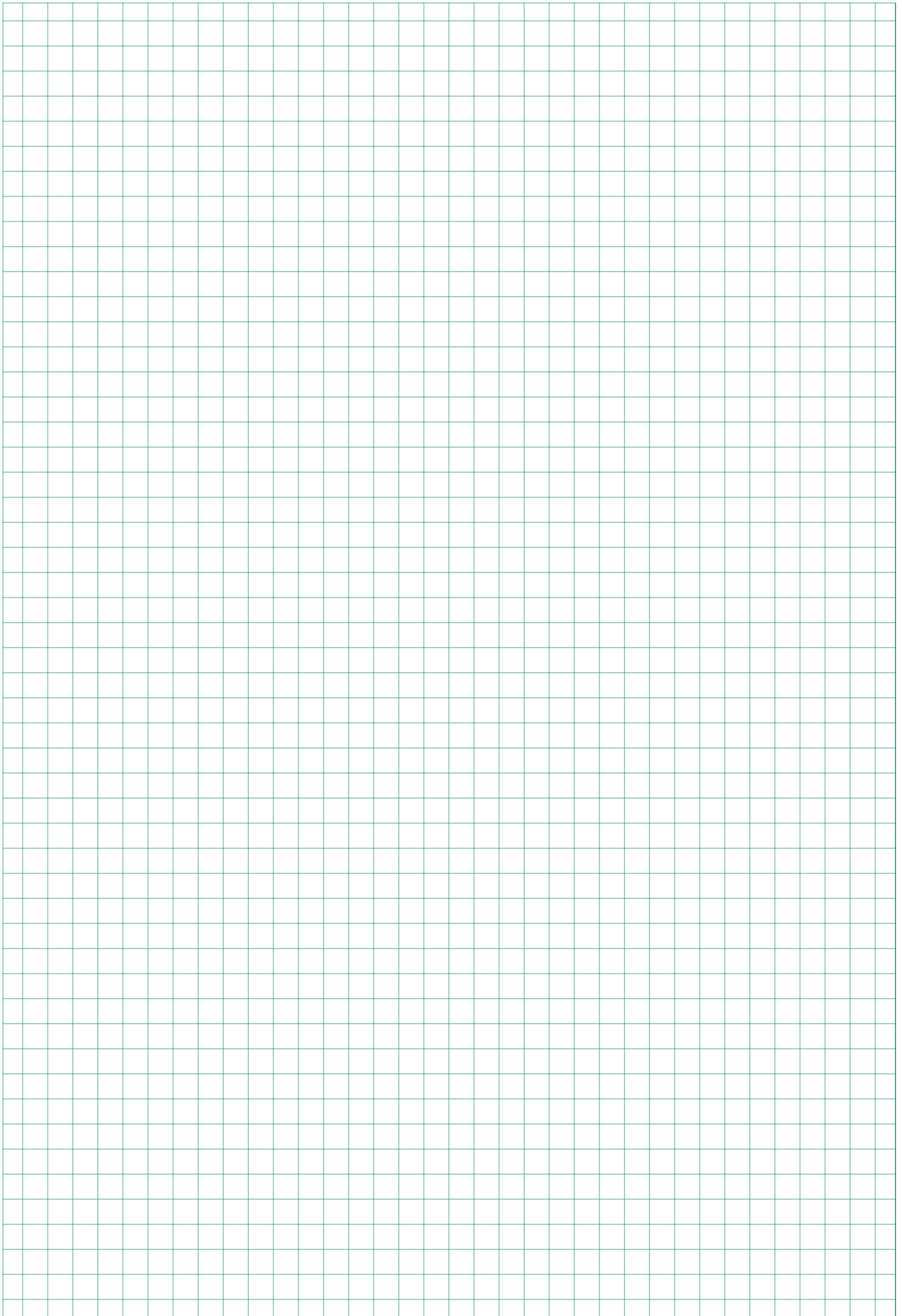



Qualität aus Österreich



D946D173



Lieblgasse 7, A-1220 Wien
Tel.: + 43 1 251 51 0
Fax: + 43 1 251 51 89
e-mail: sales@benedict.at
www.benedict.at

